

# WE'RE THE COMPANY THAT BRINGS YOU A-SERIES CEILING LIFT...



## PRISM MEDICAL'S INNOVATIVE A-SERIES CEILING LIFTS

The A-450 and the A-625 represent the next generation in lifting and handling technology that enable clients to be transferred in a comfortable and dignified manner. The A-Series displays real-time information through its interactive handset. Our Network Communication Module (NCM) software provides usage data and statistics, enabling faster diagnostics and service.

**PRISM MEDICAL**

Prism Medical Ltd.

485 Millway Avenue, Unit 2, Concord, ON Canada L4K 3 V4 | T 416.260.2145 | 1.877.304.5438

[www.prismmedical.ca](http://www.prismmedical.ca)

# THE ANATOMY OF THE A-SERIES LIFT

EMERGENCY DOWN /  
EMERGENCY STOP



ANTIMICROBIAL  
STRAP WITH WEAR  
INDICATORS

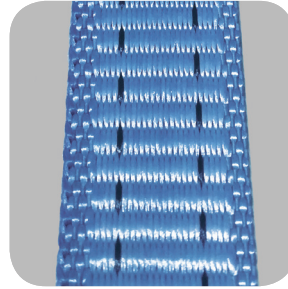

QUICK RELEASE  
SYSTEM



ACTIVE STATUS  
DISPLAY HANDSET



WI-FI ENABLED FOR  
EASE OF DIAGNOSTICS  
AND SERVICE

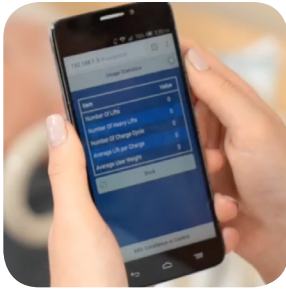

TROLLEY DESIGN -  
15° TILT

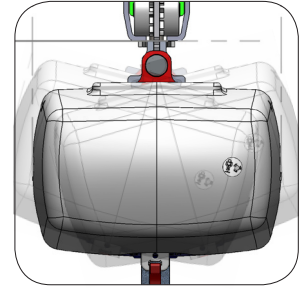

CARRY BAR WITH SPRING-LOADED LOCKS

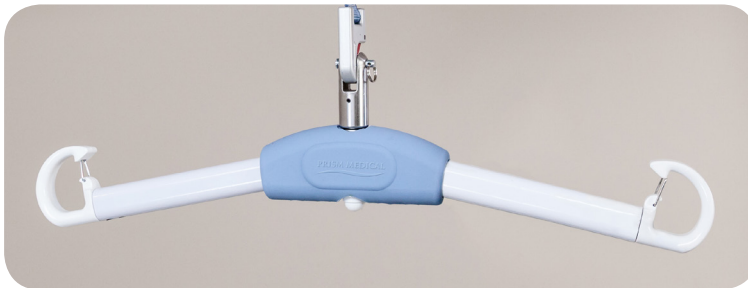

ON-CABLE  
CHARGING FEATURE



# KEY FEATURES AND BENEFITS

## ACTIVE STATUS DISPLAY HANDSET

For easy and comprehensive operation of the A-Series lift, our user-friendly handset provides real-time information on its display. It uses 3 modes of operation: Control, Weighing and Diagnostic. Within the Diagnostic Mode, a wide variety of standard open data collection fields are available.

### Control Mode

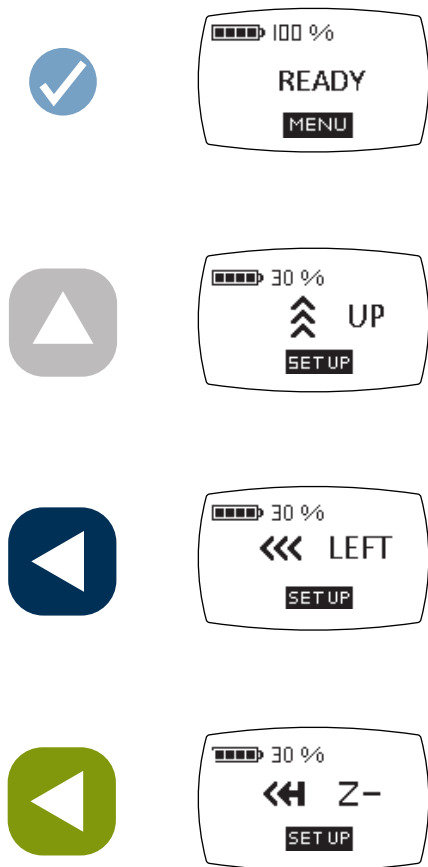

### Weighing Mode



### Diagnostic Mode

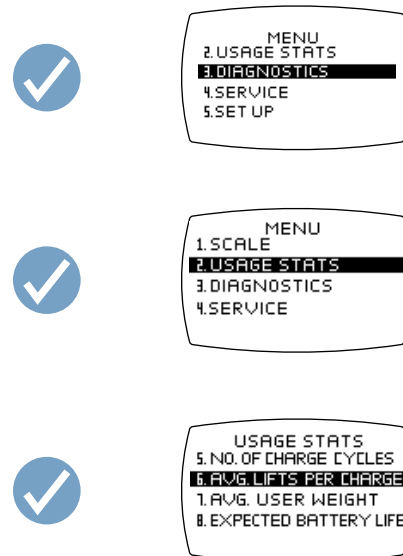

## 3 HANDSET OPTIONS

Depending on your choice of lift features, there are 3 handsets available – all with the option of ON-CABLE charging. These handsets are ergonomically designed and waterproof rated IPx6/IPx7 (Ingress Protection Rating).



Manual traverse handset



Power traverse handset



X-Y Power traverse handset

# KEY FEATURES AND BENEFITS continued

## CARRY BAR (FOR LOOP SLINGS)

These ergonomically designed carry bars include an easy swivel feature for improving the positioning of clients during transfers. There are 3 different carry bar spans available – small (17”), medium (20.5”) and large (26.4”) for comfortable sling positioning depending on your client’s size.



2-Point Locking Carry Bar

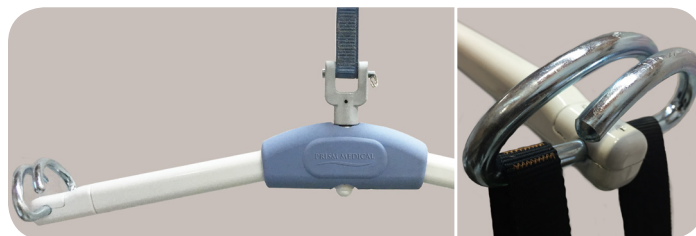

4-Point Carry Bar



## QUICK RELEASE SYSTEM (QRS)

This optional feature enables easy inter-changeability of carry bars depending on your client needs.

## ANTIMICROBIAL STRAP WITH WEAR INDICATORS

Prism A-Series lifts are easy to clean and disinfect. Its superior strap provides aid in infection control due to its specialized antimicrobial coating at the fiber level.

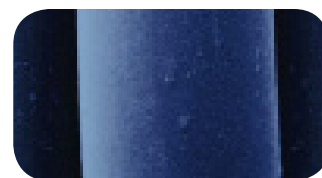
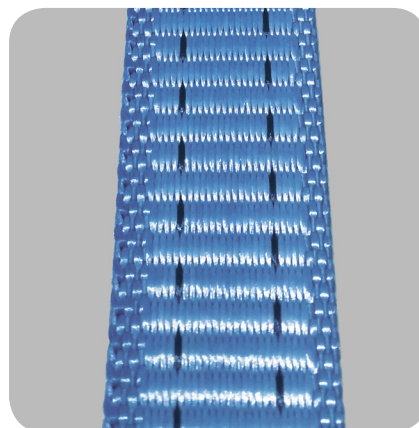

Our Coated fiber



Uncoated fiber

All Prism's existing carry bars are compatible with the A-Series lifts.



2-point carry bar



2-point carry bar with locking clips



4-point bariatric carry bar

## WEIGHING MODE

This optional feature can be integrated into the A-625 and A-450 motors. This mode allows effortless weighing of your clients when they are being lifted or transferred and increases the lifting range.

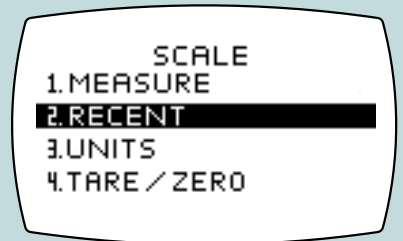
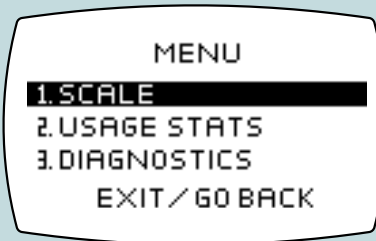
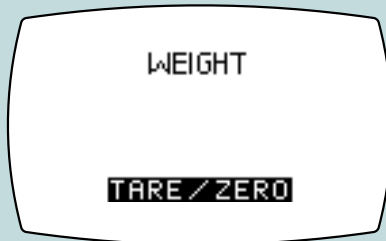

## AUTO RAISE FUNCTION (ARF)

The ARF feature conveniently raises the carry bar away from the patient after each transfer to a pre-set height.

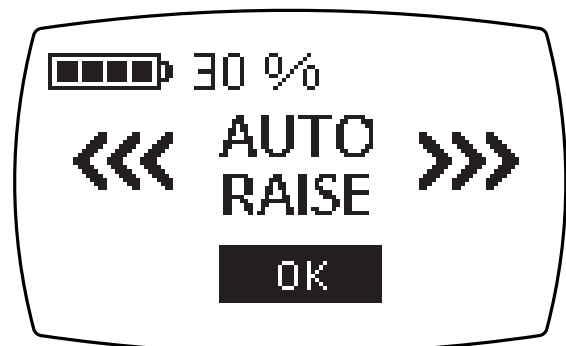

# MAKING THE HEALTHCARE EXPERIENCE BETTER

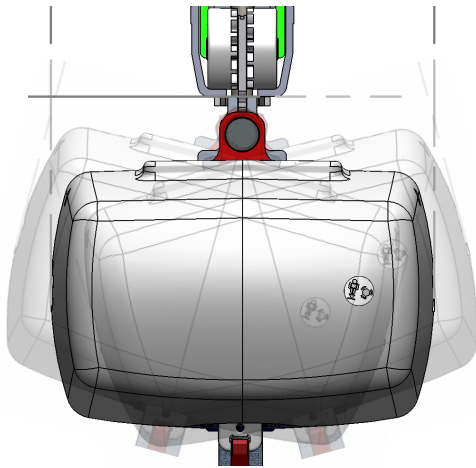

## TROLLEY DESIGN - 15° TILT

The A-Series ceiling lift tilt trolley facilitates the repositioning of your client during lifting or transferring activities by allowing a 15 degree tilt.

## EMERGENCY DOWN / EMERGENCY STOP

In case of an emergency pulling the red emergency lowering cord will immediately stop the lift and temporarily disable all of its functions. The red cord can also be used for emergency down to safety lower the client to the desired height in case of a power failure.



## CHARGING OPTIONS

There are 4 options for charging a Prism A-Series lift:

- Charging station on track
- Continuous charging on track
- ON-CABLE charging through handset
- Handset wall cradle charging

# LIMITING YOUR DOWNTIME WITH MORE EFFICIENT SERVICE

## WI-FI ENABLE FOR EASE OF DIAGNOSTICS AND SERVICE

Service and Diagnostics are made easy with the NCM, Network Communication Module software. Technicians can access the lift data via WI-FI.

The A-Series has a detachable trolley for ease of service and its design provides side access for service and replacement of batteries.



## Diagnostic Tool - Handset Control

USAGE STATS

5. NO. OF CHARGE CYCLES
- 6. AVG. LIFTS PER CHARGE**
7. AVG. USER WEIGHT
8. EXPECTED BATTERY LIFE

USAGE STATS

- 6. AVG. LIFTS PER CHARGE**
7. AVG. USER WEIGHT
8. EXPECTED BATTERY LIFE
9. EXIT / GO BACK

RECENT FAULTS

1. LIFT OVERLOAD WARNING
- 2. RTC OVERLOAD WARNING**
3. TOP LIMIT WARNING
4. SLACK WARNING

RECENT FAULTS

2. RTC OVERLOAD WARNING
- 3. TOP LIMIT WARNING**
4. SLACK WARNING
5. OVER CURRENT WARNING

## Diagnostic Tool - Computer/Smartphone

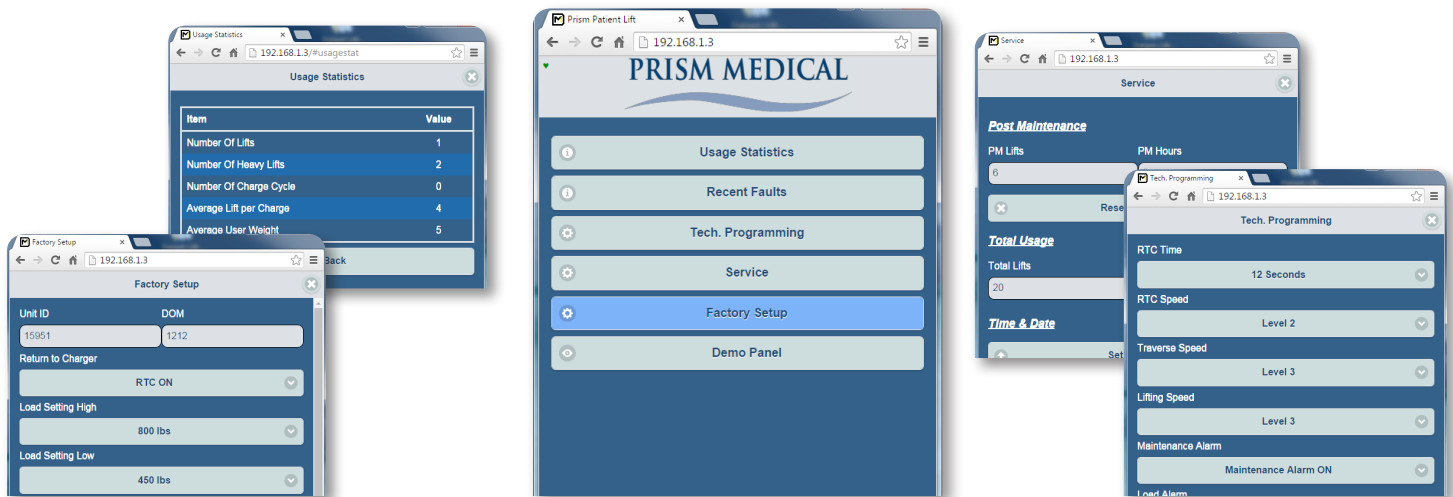

# SPECIFICATIONS FOR A-450 AND A-625

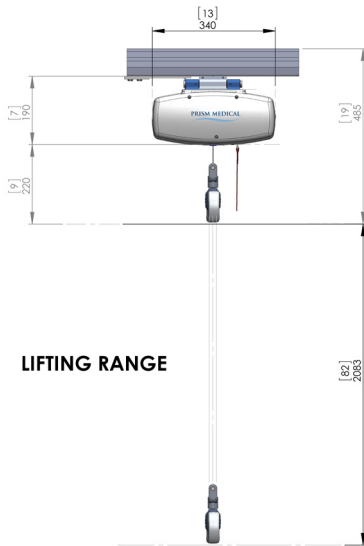

LIFTING RANGE



Lift Motor:	24 VDC
Charger Alternate 1 Model:	Soneil, PS2403SRM26
Charger Alternate 1 Input:	100-240 VAC 0.5 Amps, 50-60 Hz
Charger Alternate 1 Output:	24 VDC, 1.33Amps
Batteries:	24 VDC (2 x 12 VDC) 5.0 AH, Sealed Lead Acid
Lift Case:	Flame Retardant ABS
Hand Control:	Digital
Lifting Range:	Up to 96" (2438mm)
Lift Weight:	21-23.5 lbs.(9.5-10.65Kg)
Maximum Load:	A-450: 450lbs (204 Kgs). A-625: 625 lbs(283 Kgs).
Duty Cycle:	1 Min "ON" – 9 Mins "OFF"
Rated Performance:	A-450: 50-60 lifts at maximum load A-625: 30-40 lifts at maximum load
Max Sound Level:	
Raising Max load	56.1 dB
Lowering Max load	60.3 dB
Service Life:	22500 Cycles or 10 years

## PRODUCT

## PART NUMBER

A-450 Manual traverse	324100
A-450 Manual traverse w/load cell and WiFi	324103
A-625 Manual traverse	324117
A-625 Manual traverse w/load cell and WiFi	324120

## PRISM MEDICAL

Prism Medical Ltd.

485 Millway Avenue, Unit 2, Concord, ON Canada L4K 3 V4 | T 416.260.2145 | 1.877.304.5438

[www.prismmedical.ca](http://www.prismmedical.ca)