

---

# New Surrey Hospital & BC Cancer Centre

MINIMUM ROOM REQUIREMENTS

## A. Ambulatory Care

---

**Appendix 1B Minimum Room Requirements**

Room Name:

Program Number(s):

1. A3.09	7.	13.	19.	25.	31.	37.	43.
2.	8.	14.	20.	26.	32.	38.	44.
3.	9.	15.	21.	27.	33.	39.	45.
4.	10.	16.	22.	28.	34.	40.	46.
5.	11.	17.	23.	29.	35.	41.	47.
6.	12.	18.	24.	30.	36.	42.	48.

**ARCHITECTURAL REQUIREMENTS**

<b>WALL AND CEILING</b> Wall Material: <input type="text" value="ARGB 1.2m AFF, GB above"/> Finish: <input type="text" value="PT"/> Ceiling Material: <input type="text" value="ACT"/> Finish: <input type="text" value="PF"/>	<b>WALL PROTECTION</b> Type: <input type="text" value="PVW"/> <input type="checkbox"/> Corner Guards <input type="checkbox"/> Hand Rails <input type="checkbox"/> Bed Bumper / Locator Height: <input type="text" value="1600 mm"/> <input type="checkbox"/> Crash Rails <input type="checkbox"/> Chair Rail	<b>GLAZING</b> <input checked="" type="checkbox"/> Interior Glazing	<b>FLOORING TYPES</b> Material: <input type="text" value="VSF"/> Base: <input type="text" value="FCB"/>	<b>ROOM ACCESSORIES</b> <input checked="" type="checkbox"/> Coat Hooks <input type="checkbox"/> Ceiling Lift <input type="checkbox"/> Magnetic Whiteboard <input type="checkbox"/> Mirror <input type="checkbox"/> Infant Change Table <input checked="" type="checkbox"/> Privacy Curtain
--	--	--	--	--

- LEGEND:**
- WALL AND CEILING LEGEND:**
- AC Architectural Ceiling
  - ACT Acoustic Ceiling Tile
  - ACT-C Cleanroom
  - ARGB Abuse-Resistant Gypsum Board
  - GB Gypsum Board
  - IRGB Impact-Resistant Gypsum Board
  - KLCT Kitchen Lay-in Ceiling Tile
  - MMRGB Moisture and Mould-Resistant Gypsum Board
  - SACT Security Acoustic Ceiling Tile
- WALL FINISHES LEGEND:**
- EWC Epoxy Wall Coating
  - HPC High Performance Coating
  - PT Paint
- CEILING FINISHES LEGEND:**
- ECC Epoxy Ceiling Coating
  - HPC High Performance Coating
  - PF Prefinished
  - PT Paint
- WALL PROTECTION LEGEND:**
- ESRP Extruded Semi-Rigid PVCu Panel
  - FRL Fibre Reinforced Laminate
  - FRP Fibreglass Reinforced Plastic
  - PVW Protective Vinyl Wallcovering
  - RHIS Rigid High Impact Sheet
  - WSSP Wetwall Solid Surface Panel
  - WVV Wetroom Vinyl Wallcovering
- FLOOR FINISHES LEGEND:**
- CFS Concrete Floor Sealer
  - EFC Epoxy Floor Coating
  - PFC Polyurethane Floor Coating
  - RAF Rubber Athletic Flooring
  - RSF Rubber Sheet Flooring
  - SCF Seamless Cushioned Flooring
  - SDRF Static-Dissipative Rubber Sheet Flooring
  - SDVF Static-Dissipative Vinyl Sheet Flooring
  - VSF Vinyl Sheet Flooring
  - WSVF Wetroom Safety Vinyl Sheet Flooring
- FLOOR BASE LEGEND:**
- FCB Flash Cove Base
  - RB Rubber Base
  - SCF Seamless Cushioned Flooring

**DOORS**

Types:

Type	Qty	Size (mm)	Material	Finish	Side Lt.	Blinds	Protect.	Privacy Film	Function	Card Reader	Mag Lock	Auto Opener	Hold Open	Hinges	Accessory 1	Accessory 2	Accessory 3	Closer

Door Remarks:  Security Grille  Anti-barricade strategy

**MILLWORK AND SPECIALTY CASEWORK**

**UPPER UNITS** (U1-U8) **LOWER UNITS** (L1-L9)

**RECEPTION/TRANSACTION COUNTER / CARE TEAM STATION DESK** (TC1, TC2)

**UTILITY SINK AND COUNTER UNIT** (UC1)

**Storage Requirements:**  SHELF (S1)

**FINISHES**

- Full-height Cabinet:
- Upper Millwork:
- Countertop:
- Lower Millwork:
- Shelf:

Remarks: Provide a fixed, modular partition room divider between recliners for infection control.

**Legend:**

Category	Min. Length (mm)	Motorized Adjustable Height	Standing Height	Specialty Casework
Category 0 - None				
Category 1 - Low (1% - 4%)				
Category 2 - Med (5% - 9%)				
Category 3 - High (10% or Greater)				

**MECHANICAL REQUIREMENTS**

<b>PLUMBING</b> (Quantity) Hand Hygiene Sink: <input type="text"/> Lavatory: <input type="text"/> Kitchen Sink: <input type="text"/> Seamless Kitchen Sink: <input type="text"/> Utility / Process Sink: <input type="text"/> Scrub Sink: <input type="text"/> Floor Sink: <input type="text"/> Plumbing Remarks: <input type="text"/>	Other Fixtures: <input type="checkbox"/> Shower <input type="checkbox"/> Eyewash Station <input type="checkbox"/> Tub <input type="checkbox"/> Eyewash/Shower Station <input type="checkbox"/> Ice Maker <input type="checkbox"/> Emergency Shower <input type="checkbox"/> Water Closet <input type="checkbox"/> Flush Rim Sink <input type="checkbox"/> Instantaneous Hot Water <input type="checkbox"/> Floor Drain <input type="checkbox"/> <input type="checkbox"/> Water Bottle Refill Station Other: <input type="text"/>	<b>MED / NON-MED GASES</b> (Quantity) Oxygen: <input type="text" value="1"/> Medical Air: <input type="text" value="1"/> Medical Vacuum: <input type="text" value="1"/> Nitrous Oxide: <input type="text"/> CO2: <input type="text"/> AGSS: <input type="text"/> Nitrogen: <input type="text"/> Laboratory Air: <input type="text"/> Laboratory Vacuum: <input type="text"/> Utility Compressed Air: <input type="text"/> Gas Remarks: Provide (1) set of medical gases per chair bay to Patient's right
---	---	---

**Appendix 1B Minimum Room Requirements**

Room Name:

Program Number(s):

1. A2.11	7.	13.	19.	25.	31.	37.	43.
2.	8.	14.	20.	26.	32.	38.	44.
3.	9.	15.	21.	27.	33.	39.	45.
4.	10.	16.	22.	28.	34.	40.	46.
5.	11.	17.	23.	29.	35.	41.	47.
6.	12.	18.	24.	30.	36.	42.	48.

**ARCHITECTURAL REQUIREMENTS**

<b>WALL AND CEILING</b> Wall Material: <input type="text" value="ARGB 1.2m AFF, GB above"/> Finish: <input type="text" value="PT"/> Ceiling Material: <input type="text" value="ACT"/> Finish: <input type="text" value="PF"/>	<b>WALL PROTECTION</b> Type: <input type="text" value="FRP"/> <input checked="" type="checkbox"/> Corner Guards <input type="checkbox"/> Hand Rails <input type="checkbox"/> Bed Bumper / Locator Height: <input type="text" value="1600 mm"/> <input type="checkbox"/> Crash Rails <input type="checkbox"/> Chair Rail	<b>GLAZING</b> <input type="checkbox"/> Interior Glazing	<b>FLOORING TYPES</b> Material: <input type="text" value="RSF"/> Base: <input type="text" value="FCB"/>	<b>ROOM ACCESSORIES</b> <input checked="" type="checkbox"/> Coat Hooks <input checked="" type="checkbox"/> Ceiling Lift <input checked="" type="checkbox"/> Magnetic Whiteboard <input checked="" type="checkbox"/> Mirror <input type="checkbox"/> Infant Change Table <input checked="" type="checkbox"/> Privacy Curtain
--	---	---	--	---

- LEGEND:**
- WALL AND CEILING LEGEND:**
- AC Architectural Ceiling
  - ACT Acoustic Ceiling Tile
  - ACT-C Cleanroom
  - ARGB Abuse-Resistant Gypsum Board
  - GB Gypsum Board
  - IRGB Impact-Resistant Gypsum Board
  - KLCT Kitchen Lay-in Ceiling Tile
  - MMRGB Moisture and Mould-Resistant Gypsum Board
  - SACT Security Acoustic Ceiling Tile
- WALL FINISHES LEGEND:**
- EWC Epoxy Wall Coating
  - HPC High Performance Coating
  - PT Paint
- CEILING FINISHES LEGEND:**
- ECC Epoxy Ceiling Coating
  - HPC High Performance Coating
  - PF Prefinished
  - PT Paint
- WALL PROTECTION LEGEND:**
- ESRP Extruded Semi-Rigid PVCu Panel
  - FRL Fibre Reinforced Laminate
  - FRP Fibreglass Reinforced Plastic
  - PVV Protective Vinyl Wallcovering
  - RHIS Rigid High Impact Sheet
  - WSSP Wetwall Solid Surface Panel
  - WVV Wetroom Vinyl Wallcovering
- FLOOR FINISHES LEGEND:**
- CFS Concrete Floor Sealer
  - EFC Epoxy Floor Coating
  - PFC Polyurethane Floor Coating
  - RAF Rubber Athletic Flooring
  - RSF Rubber Sheet Flooring
  - SCF Seamless Cushioned Flooring
  - SDRF Static-Dissipative Rubber Sheet Flooring
  - SDVF Static-Dissipative Vinyl Sheet Flooring
  - VSF Vinyl Sheet Flooring
  - WSVF Wetroom Safety Vinyl Sheet Flooring
- FLOOR BASE LEGEND:**
- FCB Flash Cove Base
  - RB Rubber Base
  - SCF Seamless Cushioned Flooring

**DOORS**

Types:

Note: for Type F doors, the door panels will be approximately 465/1065 unless otherwise required by the Authority

Door Remarks:  Security Grille  Anti-barricade strategy

Type	Qty	Size (mm)	Material	Finish	Side Lt	Blinds	Protect	Privacy Film	Function	Card Reader	Mag Lock	Auto Opener	Hold Open	Hinges	Accessory 1	Accessory 2	Accessory 3	Closer
F2	1	1530 x 2135	Solid Core	FRL	<input type="checkbox"/>	<input type="checkbox"/>	2 High	<input type="checkbox"/>	Passage	<input type="checkbox"/>	<input type="checkbox"/>	<input type="checkbox"/>	<input type="checkbox"/>	Butt Hinge	Astragal	Flush Bolt		

**MILLWORK AND SPECIALTY CASEWORK**

Storage Requirements:

**UPPER UNITS:** U1, U2, U3, U4, U5, U6, U7, U8

**LOWER UNITS:** L1, L2, L3, L4, L5, L6, L7, L8, L9, L10, L11, L12

**RECEPTION/TRANSACTION COUNTER / CARE TEAM STATION DESK:** TC1, TC2

**UTILITY SINK AND COUNTER UNIT:** UC1

**SHELF:** S1

**FULL-HEIGHT CABINETS:** C1, C2, C3, C4, C5

**Legend:**

Category	Min. Length (mm)	Motorized Adjustable Height	Standing Height	Specialty Casework
1	900	<input type="checkbox"/>	<input type="checkbox"/>	<input type="checkbox"/>

**FINISHES**

Full-height Cabinet:

Upper Millwork:

Countertop:

Lower Millwork:

Shelf:

Remarks:

**MECHANICAL REQUIREMENTS**

**PLUMBING**

Hand Hygiene Sink: <input type="text" value="1"/>	Lavatory: <input type="text"/>	Kitchen Sink: <input type="text"/>	Seamless Kitchen Sink: <input type="text"/>	Utility / Process Sink: <input type="text" value="1"/>	Scrub Sink: <input type="text"/>	Floor Sink: <input type="text"/>
---	--------------------------------	------------------------------------	---	--	----------------------------------	----------------------------------

Plumbing Remarks:

**Other Fixtures:**

- Shower
- Tub
- Ice Maker
- Water Closet
- Instantaneous Hot Water
- Eyewash Station
- Eyewash/Shower Station
- Emergency Shower
- Flush Rim Sink
- Floor Drain
- Water Bottle Refill Station

Other:

**MED / NON-MED GASES**

Oxygen: <input type="text" value="1"/>	Medical Air: <input type="text" value="1"/>	Medical Vacuum: <input type="text" value="1"/>	Nitrous Oxide: <input type="text"/>	CO2: <input type="text"/>	AGSS: <input type="text"/>	Nitrogen: <input type="text"/>	Laboratory Air: <input type="text"/>	Laboratory Vacuum: <input type="text"/>	Utility Compressed Air: <input type="text"/>
--	---	--	-------------------------------------	---------------------------	----------------------------	--------------------------------	--------------------------------------	---	--

Gas Remarks:

**Appendix 1B Minimum Room Requirements**

Room Name:

Program Number(s):	1. A2.01	7.	13.	19.	25.	31.	37.	43.
	2. A3.01	8.	14.	20.	26.	32.	38.	44.
	3.	9.	15.	21.	27.	33.	39.	45.
	4.	10.	16.	22.	28.	34.	40.	46.
	5.	11.	17.	23.	29.	35.	41.	47.
	6.	12.	18.	24.	30.	36.	42.	48.

**ARCHITECTURAL REQUIREMENTS**

<b>WALL AND CEILING</b> Wall Material: <input type="text" value="ARGB 1.2m AFF, GB above"/> Finish: <input type="text" value="PT"/> Ceiling Material: <input type="text" value="ARGB"/> Finish: <input type="text" value="PT"/>	<b>WALL PROTECTION</b> Type: <input type="text" value="PVW"/> <input checked="" type="checkbox"/> Corner Guards <input type="checkbox"/> Hand Rails <input type="checkbox"/> Bed Bumper / Locator Height: <input type="text" value="1350 mm"/> <input type="checkbox"/> Crash Rails <input checked="" type="checkbox"/> Chair Rail	<b>GLAZING</b> <input checked="" type="checkbox"/> Interior Glazing	<b>FLOORING TYPES</b> Material: <input type="text" value="RSF"/> Base: <input type="text" value="FCB"/>	<b>ROOM ACCESSORIES</b> <input type="checkbox"/> Coat Hooks <input type="checkbox"/> Ceiling Lift <input checked="" type="checkbox"/> Magnetic Whiteboard <input type="checkbox"/> Mirror <input type="checkbox"/> Infant Change Table <input type="checkbox"/> Privacy Curtain
---	--	--	--	---

- LEGEND:**
- WALL AND CEILING LEGEND:**
- AC Architectural Ceiling
  - ACT Acoustic Ceiling Tile
  - ACT-C Cleanroom
  - ARGB Abuse-Resistant Gypsum Board
  - GB Gypsum Board
  - IRGB Impact-Resistant Gypsum Board
  - KLCT Kitchen Lay-in Ceiling Tile
  - MMRGB Moisture and Mould-Resistant Gypsum Board
  - SACT Security Acoustic Ceiling Tile
- WALL FINISHES LEGEND:**
- EWC Epoxy Wall Coating
  - HPC High Performance Coating
  - PT Paint
- CEILING FINISHES LEGEND:**
- ECC Epoxy Ceiling Coating
  - HPC High Performance Coating
  - PF Prefinished
  - PT Paint
- WALL PROTECTION LEGEND:**
- ESRP Extruded Semi-Rigid PVCu Panel
  - FRL Fibre Reinforced Laminate
  - FRP Fibreglass Reinforced Plastic
  - PVW Protective Vinyl Wallcovering
  - RHIS Rigid High Impact Sheet
  - WSSP Wetwall Solid Surface Panel
  - WVV Wetroom Vinyl Wallcovering
- FLOOR FINISHES LEGEND:**
- CFS Concrete Floor Sealer
  - EFC Epoxy Floor Coating
  - PFC Polyurethane Floor Coating
  - RAF Rubber Athletic Flooring
  - RSF Rubber Sheet Flooring
  - SCF Seamless Cushioned Flooring
  - SDRF Static-Dissipative Rubber Sheet Flooring
  - SDVF Static-Dissipative Vinyl Sheet Flooring
  - VSF Vinyl Sheet Flooring
  - WSVF Wetroom Safety Vinyl Sheet Flooring
- FLOOR BASE LEGEND:**
- FCB Flash Cove Base
  - RB Rubber Base
  - SCF Seamless Cushioned Flooring

**DOORS**

Types:

Type	Qty	Size (mm)	Material	Finish	Side Lt	Blinds	Protect	Privacy Film	Function	Card Reader	Mag Lock	Auto Opener	Hold Open	Hinges	Accessory 1	Accessory 2	Accessory 3	Closer
C	1	1065 x 2135	Solid Core	FRL	<input type="checkbox"/>	<input type="checkbox"/>	1 Low	<input type="checkbox"/>	Storeroom	<input checked="" type="checkbox"/>	<input type="checkbox"/>	<input type="checkbox"/>	<input type="checkbox"/>	Cont. Double-Acting	Safety Stop			Surface

Door Remarks:  Security Grille  Anti-barricade strategy

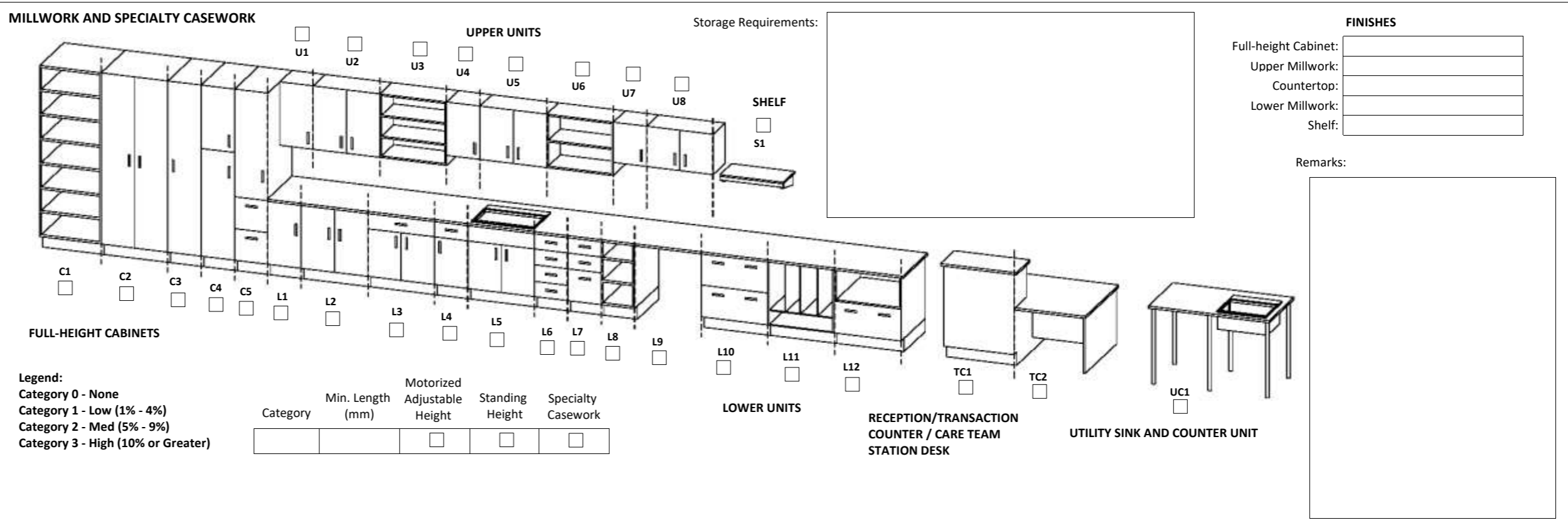

**MECHANICAL REQUIREMENTS**

<b>PLUMBING</b> (Quantity) Hand Hygiene Sink: <input type="text"/> Lavatory: <input type="text"/> Kitchen Sink: <input type="text"/> Seamless Kitchen Sink: <input type="text"/> Utility / Process Sink: <input type="text"/> Scrub Sink: <input type="text"/> Floor Sink: <input type="text"/> Plumbing Remarks: <input type="text"/>	Other Fixtures: <input type="checkbox"/> Shower <input type="checkbox"/> Eyewash Station <input type="checkbox"/> Tub <input type="checkbox"/> Eyewash/Shower Station <input type="checkbox"/> Ice Maker <input type="checkbox"/> Emergency Shower <input type="checkbox"/> Water Closet <input type="checkbox"/> Flush Rim Sink <input type="checkbox"/> Instantaneous Hot Water <input type="checkbox"/> Floor Drain <input type="checkbox"/> <input type="checkbox"/> Water Bottle Refill Station Other: <input type="text"/>	<b>MED / NON-MED GASES</b> (Quantity) Oxygen: <input type="text"/> Medical Air: <input type="text"/> Medical Vacuum: <input type="text"/> Nitrous Oxide: <input type="text"/> CO2: <input type="text"/> AGSS: <input type="text"/> Nitrogen: <input type="text"/> Laboratory Air: <input type="text"/> Laboratory Vacuum: <input type="text"/> Utility Compressed Air: <input type="text"/> Gas Remarks: <input type="text"/>
---	---	---



---

# New Surrey Hospital & BC Cancer Centre

MINIMUM ROOM REQUIREMENTS

## **B. Inpatient Unit**

---

**Appendix 1B Minimum Room Requirements**

Room Name:

Program Number(s):

1. B1.19	7.	13.	19.	25.	31.	37.	43.
2. B2.24	8.	14.	20.	26.	32.	38.	44.
3. B3.24	9.	15.	21.	27.	33.	39.	45.
4.	10.	16.	22.	28.	34.	40.	46.
5.	11.	17.	23.	29.	35.	41.	47.
6.	12.	18.	24.	30.	36.	42.	48.

**ARCHITECTURAL REQUIREMENTS**

<b>WALL AND CEILING</b> Wall Material: <input type="text" value="ARGB 1.2m AFF, GB above"/> Finish: <input type="text" value="PT"/> Ceiling Material: <input type="text" value="ACT"/> Finish: <input type="text" value="PF"/>		<b>WALL PROTECTION</b> Type: <input type="text" value="PVW"/> <input checked="" type="checkbox"/> Corner Guards <input type="checkbox"/> Hand Rails <input type="checkbox"/> Bed Bumper / Locator Height: <input type="text" value="2185 mm"/> <input checked="" type="checkbox"/> Crash Rails <input type="checkbox"/> Chair Rail		<b>GLAZING</b> <input type="checkbox"/> Interior Glazing		<b>FLOORING TYPES</b> Material: <input type="text" value="VSF"/> Base: <input type="text" value="FCB"/>		<b>ROOM ACCESSORIES</b> <input type="checkbox"/> Coat Hooks <input type="checkbox"/> Ceiling Lift <input type="checkbox"/> Magnetic Whiteboard <input type="checkbox"/> Mirror <input type="checkbox"/> Infant Change Table <input type="checkbox"/> Privacy Curtain	
--	--	--	--	---	--	--	--	--	--

- LEGEND:**
- WALL AND CEILING LEGEND:**
- AC Architectural Ceiling
  - ACT Acoustic Ceiling Tile
  - ACT-C Cleanroom
  - ARGB Abuse-Resistant Gypsum Board
  - GB Gypsum Board
  - IRGB Impact-Resistant Gypsum Board
  - KLCT Kitchen Lay-in Ceiling Tile
  - MMRGB Moisture and Mould-Resistant Gypsum Board
  - SACT Security Acoustic Ceiling Tile
- WALL FINISHES LEGEND:**
- EWC Epoxy Wall Coating
  - HPC High Performance Coating
  - PT Paint
- CEILING FINISHES LEGEND:**
- ECC Epoxy Ceiling Coating
  - HPC High Performance Coating
  - PF Prefinished
  - PT Paint
- WALL PROTECTION LEGEND:**
- ESRP Extruded Semi-Rigid PVCu Panel
  - FRL Fibre Reinforced Laminate
  - FRP Fibreglass Reinforced Plastic
  - PVW Protective Vinyl Wallcovering
  - RHIS Rigid High Impact Sheet
  - WSSP Wetwall Solid Surface Panel
  - WVV Wetroom Vinyl Wallcovering
- FLOOR FINISHES LEGEND:**
- CFS Concrete Floor Sealer
  - EFC Epoxy Floor Coating
  - PFC Polyurethane Floor Coating
  - RAF Rubber Athletic Flooring
  - RSF Rubber Sheet Flooring
  - SCF Seamless Cushioned Flooring
  - SDRF Static-Dissipative Rubber Sheet Flooring
  - SDVF Static-Dissipative Vinyl Sheet Flooring
  - VSF Vinyl Sheet Flooring
  - WSVF Wetroom Safety Vinyl Sheet Flooring
- FLOOR BASE LEGEND:**
- FCB Flash Cove Base
  - RB Rubber Base
  - SCF Seamless Cushioned Flooring

**DOORS**

Types:

Type	Qty	Size (mm)	Material	Finish	Side Lt	Blinds	Protect	Privacy Film	Function	Card Reader	Mag Lock	Auto Opener	Hold Open	Hinges	Accessory 1	Accessory 2	Accessory 3	Closer

Door Remarks:  Security Grille  Anti-barricade strategy

**MILLWORK AND SPECIALTY CASEWORK**

**UPPER UNITS** (U1-U8) **LOWER UNITS** (L1-L12) **RECEPTION/TRANSACTION COUNTER / CARE TEAM STATION DESK** (TC1-TC2) **UTILITY SINK AND COUNTER UNIT** (UC1)

Storage Requirements:

**FINISHES**

Full-height Cabinet:   
 Upper Millwork:   
 Countertop:   
 Lower Millwork:   
 Shelf:

Remarks:

**Legend:**

Category	Min. Length (mm)	Motorized Adjustable Height	Standing Height	Specialty Casework
Category 0 - None				
Category 1 - Low (1% - 4%)				
Category 2 - Med (5% - 9%)				
Category 3 - High (10% or Greater)				

**MECHANICAL REQUIREMENTS**

<b>PLUMBING</b> (Quantity) Hand Hygiene Sink: <input type="text"/> Lavatory: <input type="text"/> Kitchen Sink: <input type="text"/> Seamless Kitchen Sink: <input type="text"/> Utility / Process Sink: <input type="text"/> Scrub Sink: <input type="text"/> Floor Sink: <input type="text"/> Plumbing Remarks: <input type="text"/>		Other Fixtures: <input type="checkbox"/> Shower <input type="checkbox"/> Eyewash Station <input type="checkbox"/> Tub <input type="checkbox"/> Eyewash/Shower Station <input type="checkbox"/> Ice Maker <input type="checkbox"/> Emergency Shower <input type="checkbox"/> Water Closet <input type="checkbox"/> Flush Rim Sink <input type="checkbox"/> Instantaneous Hot Water <input type="checkbox"/> Floor Drain <input type="checkbox"/> Water Bottle Refill Station Other <input type="text"/>		<b>MED / NON-MED GASES</b> (Quantity) Oxygen: <input type="text"/> Medical Air: <input type="text"/> Medical Vacuum: <input type="text"/> Nitrous Oxide: <input type="text"/> CO2: <input type="text"/> AGSS: <input type="text"/> Nitrogen: <input type="text"/> Laboratory Air: <input type="text"/> Laboratory Vacuum: <input type="text"/> Utility Compressed Air: <input type="text"/> Gas Remarks: <input type="text"/>	
--	--	---	--	--	--

**Appendix 1B Minimum Room Requirements**

Room Name:

Program Number(s):	1. B4.05c	7.	13.	19.	25.	31.	37.	43.
	2.	8.	14.	20.	26.	32.	38.	44.
	3.	9.	15.	21.	27.	33.	39.	45.
	4.	10.	16.	22.	28.	34.	40.	46.
	5.	11.	17.	23.	29.	35.	41.	47.
	6.	12.	18.	24.	30.	36.	42.	48.

**ARCHITECTURAL REQUIREMENTS**

<b>WALL AND CEILING</b> Wall Material: <input type="text" value="ARGB 1.2m AFF, GB above"/> Finish: <input type="text" value="EWC"/> Ceiling Material: <input type="text" value="ACT"/> Finish: <input type="text" value="PF"/>	<b>WALL PROTECTION</b> Type: <input type="text" value="WVW"/> <input checked="" type="checkbox"/> Corner Guards <input type="checkbox"/> Hand Rails <input type="checkbox"/> Bed Bumper / Locator Height: <input type="text" value="2185 mm"/> <input type="checkbox"/> Crash Rails <input type="checkbox"/> Chair Rail	<b>GLAZING</b> <input type="checkbox"/> Interior Glazing	<b>FLOORING TYPES</b> Material: <input type="text" value="WSVF"/> Base: <input type="text" value="FCB"/>	<b>ROOM ACCESSORIES</b> <input type="checkbox"/> Coat Hooks <input type="checkbox"/> Ceiling Lift <input checked="" type="checkbox"/> Magnetic Whiteboard <input type="checkbox"/> Mirror <input type="checkbox"/> Infant Change Table <input type="checkbox"/> Privacy Curtain
---	---	---	---	---

- LEGEND:**
- WALL AND CEILING LEGEND:**
- AC Architectural Ceiling
  - ACT Acoustic Ceiling Tile
  - ACT-C Cleanroom
  - ARGB Abuse-Resistant Gypsum Board
  - GB Gypsum Board
  - IRGB Impact-Resistant Gypsum Board
  - KLCT Kitchen Lay-in Ceiling Tile
  - MMRGB Moisture and Mould-Resistant Gypsum Board
  - SACT Security Acoustic Ceiling Tile
- WALL FINISHES LEGEND:**
- EWC Epoxy Wall Coating
  - HPC High Performance Coating
  - PT Paint
- CEILING FINISHES LEGEND:**
- ECC Epoxy Ceiling Coating
  - HPC High Performance Coating
  - PF Prefinished
  - PT Paint
- WALL PROTECTION LEGEND:**
- ESRP Extruded Semi-Rigid PVCu Panel
  - FRL Fibre Reinforced Laminate
  - FRP Fibreglass Reinforced Plastic
  - PVW Protective Vinyl Wallcovering
  - RHIS Rigid High Impact Sheet
  - WSSP Wetwall Solid Surface Panel
  - WVV Wetroom Vinyl Wallcovering
- FLOOR FINISHES LEGEND:**
- CFS Concrete Floor Sealer
  - EFC Epoxy Floor Coating
  - PFC Polyurethane Floor Coating
  - RAF Rubber Athletic Flooring
  - RSF Rubber Sheet Flooring
  - SCF Seamless Cushioned Flooring
  - SDRF Static-Dissipative Rubber Sheet Flooring
  - SDVF Static-Dissipative Vinyl Sheet Flooring
  - VSF Vinyl Sheet Flooring
  - WSVF Wetroom Safety Vinyl Sheet Flooring
- FLOOR BASE LEGEND:**
- FCB Flash Cove Base
  - RB Rubber Base
  - SCF Seamless Cushioned Flooring

**DOORS**

Types:

Note: for Type F doors, the door panels will be approximately 465/1065 unless otherwise required by the Authority

Type	Qty	Size (mm)	Material	Finish	Side Lt.	Blinds	Protect.	Privacy Film	Function	Card Reader	Mag Lock	Auto Opener	Hold Open	Hinges	Accessory 1	Accessory 2	Accessory 3	Closer
F2	1	1530 x 2135	Solid Core	FRL	<input type="checkbox"/>	<input type="checkbox"/>	2 High	<input type="checkbox"/>	Storeroom	<input checked="" type="checkbox"/>	<input type="checkbox"/>	<input type="checkbox"/>	<input checked="" type="checkbox"/>	Butt Hinge	Astragal	Flush Bolt		Surface
F2	1	1530 x 2135	Solid Core	FRL	<input type="checkbox"/>	<input type="checkbox"/>	2 High	<input type="checkbox"/>	Passage	<input type="checkbox"/>	<input type="checkbox"/>	<input type="checkbox"/>	<input type="checkbox"/>	Butt Hinge	Astragal	Flush Bolt		Surface

**DOOR REMARKS:**

Security Grille  
 Anti-barricade strategy

**MILLWORK AND SPECIALTY CASEWORK**

Storage Requirements:

**UPPER UNITS:** U1, U2, U3, U4, U5, U6, U7, U8

**LOWER UNITS:** L1, L2, L3, L4, L5, L6, L7, L8, L9, L10, L11, L12

**RECEPTION/TRANSACTION COUNTER / CARE TEAM STATION DESK:** TC1, TC2

**UTILITY SINK AND COUNTER UNIT:** UC1

**SHELF:** S1

**FULL-HEIGHT CABINETS:** C1, C2, C3, C4, C5

**Legend:**

Category	Min. Length (mm)	Motorized Adjustable Height	Standing Height	Specialty Casework
1	1800	<input type="checkbox"/>	<input type="checkbox"/>	<input type="checkbox"/>

**FINISHES**

Full-height Cabinet:   
 Upper Millwork:   
 Countertop:   
 Lower Millwork:   
 Shelf:

**REMARKS:**

**MECHANICAL REQUIREMENTS**

**PLUMBING**

Hand Hygiene Sink:	Lavatory:	Kitchen Sink:	Seamless Kitchen Sink:	Utility / Process Sink:	Scrub Sink:	Floor Sink:
1				1		

Plumbing Remarks:

**Other Fixtures:**

- Shower
- Tub
- Ice Maker
- Water Closet
- Instantaneous Hot Water
- Eyewash Station
- Eyewash/Shower Station
- Emergency Shower
- Flush Rim Sink
- Floor Drain
- Water Bottle Refill Station

Other:

**MED / NON-MED GASES**

Oxygen:	Medical Air:	Medical Vacuum:	Nitrous Oxide:	CO2:	AGSS:	Nitrogen:	Laboratory Air:	Laboratory Vacuum:	Utility Compressed Air:

Gas Remarks:

**Appendix 1B Minimum Room Requirements**

Room Name:

Program Number(s):

1. B2.28	7.	13.	19.	25.	31.	37.	43.
2. B4.01	8.	14.	20.	26.	32.	38.	44.
3.	9.	15.	21.	27.	33.	39.	45.
4.	10.	16.	22.	28.	34.	40.	46.
5.	11.	17.	23.	29.	35.	41.	47.
6.	12.	18.	24.	30.	36.	42.	48.

**ARCHITECTURAL REQUIREMENTS**

<b>WALL AND CEILING</b> Wall Material: <input type="text" value="ARGB 1.2m AFF, GB above"/> Finish: <input type="text" value="PT"/> Ceiling Material: <input type="text" value="ACT"/> Finish: <input type="text" value="PF"/>		<b>WALL PROTECTION</b> Type: <input type="text" value="FRL"/> <input checked="" type="checkbox"/> Corner Guards <input type="checkbox"/> Hand Rails <input type="checkbox"/> Bed Bumper / Locator Height: <input type="text" value="1350 mm"/> <input type="checkbox"/> Crash Rails <input checked="" type="checkbox"/> Chair Rail		<b>GLAZING</b> <input checked="" type="checkbox"/> Interior Glazing		<b>FLOORING TYPES</b> Material: <input type="text" value="VSF"/> Base: <input type="text" value="FCB"/>		<b>ROOM ACCESSORIES</b> <input checked="" type="checkbox"/> Coat Hooks <input type="checkbox"/> Ceiling Lift <input type="checkbox"/> Magnetic Whiteboard <input type="checkbox"/> Mirror <input type="checkbox"/> Infant Change Table <input type="checkbox"/> Privacy Curtain	
--	--	--	--	--	--	--	--	---	--

- LEGEND:**
- WALL AND CEILING LEGEND:**
- AC Architectural Ceiling
  - ACT Acoustic Ceiling Tile
  - ACT-C Cleanroom
  - ARGB Abuse-Resistant Gypsum Board
  - GB Gypsum Board
  - IRGB Impact-Resistant Gypsum Board
  - KLCT Kitchen Lay-in Ceiling Tile
  - MMRGB Moisture and Mould-Resistant Gypsum Board
  - SACT Security Acoustic Ceiling Tile
- WALL FINISHES LEGEND:**
- EWC Epoxy Wall Coating
  - HPC High Performance Coating
  - PT Paint
- CEILING FINISHES LEGEND:**
- ECC Epoxy Ceiling Coating
  - HPC High Performance Coating
  - PF Prefinished
  - PT Paint
- WALL PROTECTION LEGEND:**
- ESRP Extruded Semi-Rigid PVCu Panel
  - FRL Fibre Reinforced Laminate
  - FRP Fibreglass Reinforced Plastic
  - PVVW Protective Vinyl Wallcovering
  - RHIS Rigid High Impact Sheet
  - WSSP Wetwall Solid Surface Panel
  - WVVW Wetroom Vinyl Wallcovering
- FLOOR FINISHES LEGEND:**
- CFS Concrete Floor Sealer
  - EFC Epoxy Floor Coating
  - PFC Polyurethane Floor Coating
  - RAF Rubber Athletic Flooring
  - RSF Rubber Sheet Flooring
  - SCF Seamless Cushioned Flooring
  - SDRF Static-Dissipative Rubber Sheet Flooring
  - SDVF Static-Dissipative Vinyl Sheet Flooring
  - VSF Vinyl Sheet Flooring
  - WSVF Wetroom Safety Vinyl Sheet Flooring
- FLOOR BASE LEGEND:**
- FCB Flash Cove Base
  - RB Rubber Base
  - SCF Seamless Cushioned Flooring

**DOORS**

Types:

Type	Qty	Size (mm)	Material	Finish	Side Lt.	Blinds	Protect.	Privacy Film	Function	Card Reader	Mag Lock	Auto Opener	Hold Open	Hinges	Accessory 1	Accessory 2	Accessory 3	Closer
B	1	1065 x 2135	Solid Core	FRL	<input type="checkbox"/>	<input type="checkbox"/>	1 Low	<input type="checkbox"/>	Passage	<input type="checkbox"/>	<input type="checkbox"/>	<input type="checkbox"/>	<input type="checkbox"/>	Butt Hinge				Concealed

**DOOR REMARKS:**

Security Grille  
 Anti-barricade strategy

**MILLWORK AND SPECIALTY CASEWORK**

**UPPER UNITS:** U1, U2, U3, U4, U5, U6, U7, U8

**LOWER UNITS:** L1, L2, L3, L4, L5, L6, L7, L8, L9, L10, L11, L12

**RECEPTION/TRANSACTION COUNTER / CARE TEAM STATION DESK:** TC1, TC2

**UTILITY SINK AND COUNTER UNIT:** UC1

**SHELF:** S1

**Storage Requirements:**

**FINISHES**

Full-height Cabinet:   
 Upper Millwork:   
 Countertop:   
 Lower Millwork:   
 Shelf:

**Remarks:**

**MECHANICAL REQUIREMENTS**

<b>PLUMBING</b> (Quantity) Hand Hygiene Sink: <input type="text"/> Lavatory: <input type="text"/> Kitchen Sink: <input type="text"/> Seamless Kitchen Sink: <input type="text"/> Utility / Process Sink: <input type="text"/> Scrub Sink: <input type="text"/> Floor Sink: <input type="text"/>		Other Fixtures: <input type="checkbox"/> Shower <input type="checkbox"/> Eyewash Station <input type="checkbox"/> Tub <input type="checkbox"/> Eyewash/Shower Station <input type="checkbox"/> Ice Maker <input type="checkbox"/> Emergency Shower <input type="checkbox"/> Water Closet <input type="checkbox"/> Flush Rim Sink <input type="checkbox"/> Instantaneous Hot Water <input checked="" type="checkbox"/> Water Bottle Refill Station Other: <input type="text"/>		<b>MED / NON-MED GASES</b> (Quantity) Oxygen: <input type="text"/> Medical Air: <input type="text"/> Medical Vacuum: <input type="text"/> Nitrous Oxide: <input type="text"/> CO2: <input type="text"/> AGSS: <input type="text"/> Nitrogen: <input type="text"/> Laboratory Air: <input type="text"/> Laboratory Vacuum: <input type="text"/> Utility Compressed Air: <input type="text"/>	
Plumbing Remarks: <input type="text"/>		Gas Remarks: <input type="text"/>			



**Appendix 1B Minimum Room Requirements**

Room Name:

Program Number(s):

1. B4.05a	7.	13.	19.	25.	31.	37.	43.
2.	8.	14.	20.	26.	32.	38.	44.
3.	9.	15.	21.	27.	33.	39.	45.
4.	10.	16.	22.	28.	34.	40.	46.
5.	11.	17.	23.	29.	35.	41.	47.
6.	12.	18.	24.	30.	36.	42.	48.

**ARCHITECTURAL REQUIREMENTS**

<b>WALL AND CEILING</b> Wall Material: <input type="text" value="ARGB 1.2m AFF, GB above"/> Finish: <input type="text" value="PT"/> Ceiling Material: <input type="text" value="ACT"/> Finish: <input type="text" value="PF"/>	<b>WALL PROTECTION</b> Type: <input type="text" value="PVW"/> <input checked="" type="checkbox"/> Corner Guards <input type="checkbox"/> Hand Rails <input type="checkbox"/> Bed Bumper / Locator Height: <input type="text" value="1350 mm"/> <input type="checkbox"/> Crash Rails <input type="checkbox"/> Chair Rail	<b>GLAZING</b> <input type="checkbox"/> Interior Glazing	<b>FLOORING TYPES</b> Material: <input type="text" value="RAF"/> Base: <input type="text" value="FCB"/>	<b>ROOM ACCESSORIES</b> <input checked="" type="checkbox"/> Coat Hooks <input checked="" type="checkbox"/> Ceiling Lift <input checked="" type="checkbox"/> Magnetic Whiteboard <input checked="" type="checkbox"/> Mirror <input type="checkbox"/> Infant Change Table <input checked="" type="checkbox"/> Privacy Curtain
--	---	---	--	---

- LEGEND:**
- WALL AND CEILING LEGEND:**
- AC Architectural Ceiling
  - ACT Acoustic Ceiling Tile
  - ACT-C Cleanroom
  - ARGB Abuse-Resistant Gypsum Board
  - GB Gypsum Board
  - IRGB Impact-Resistant Gypsum Board
  - KLCT Kitchen Lay-in Ceiling Tile
  - MMRGB Moisture and Mould-Resistant Gypsum Board
  - SACT Security Acoustic Ceiling Tile
- WALL FINISHES LEGEND:**
- EWC Epoxy Wall Coating
  - HPC High Performance Coating
  - PT Paint
- CEILING FINISHES LEGEND:**
- ECC Epoxy Ceiling Coating
  - HPC High Performance Coating
  - PF Prefinished
  - PT Paint
- WALL PROTECTION LEGEND:**
- ESRP Extruded Semi-Rigid PVCu Panel
  - FRL Fibre Reinforced Laminate
  - FRP Fibreglass Reinforced Plastic
  - PVW Protective Vinyl Wallcovering
  - RHIS Rigid High Impact Sheet
  - WSSP Wetwall Solid Surface Panel
  - WVV Wetroom Vinyl Wallcovering
- FLOOR FINISHES LEGEND:**
- CFS Concrete Floor Sealer
  - EFC Epoxy Floor Coating
  - PFC Polyurethane Floor Coating
  - RAF Rubber Athletic Flooring
  - RSF Rubber Sheet Flooring
  - SCF Seamless Cushioned Flooring
  - SDRF Static-Dissipative Rubber Sheet Flooring
  - SDVF Static-Dissipative Vinyl Sheet Flooring
  - VSF Vinyl Sheet Flooring
  - WSVF Wetroom Safety Vinyl Sheet Flooring
- FLOOR BASE LEGEND:**
- FCB Flash Cove Base
  - RB Rubber Base
  - SCF Seamless Cushioned Flooring

**DOORS**

Types:

Note: for Type F doors, the door panels will be approximately 465/1065 unless otherwise required by the Authority

Door Remarks:  Security Grille  Anti-barricade strategy

F door to provide access to Public Circulation and F2 door is to provide access to Service Circulation

Type	Qty	Size (mm)	Material	Finish	Side Lt	Blinds	Protect	Privacy Film	Function	Card Reader	Mag Lock	Auto Opener	Hold Open	Hinges	Accessory 1	Accessory 2	Accessory 3	Closer
F	1	1530 x 2135	Solid Core	FRL	<input type="checkbox"/>	<input type="checkbox"/>	2 High	<input type="checkbox"/>	Storeroom	<input checked="" type="checkbox"/>	<input type="checkbox"/>	<input type="checkbox"/>	<input checked="" type="checkbox"/>	Butt Hinge	Astragal	Flush Bolt		Surface
F2	1	1530 x 2135	Solid Core	FRL	<input type="checkbox"/>	<input type="checkbox"/>	1 Low	<input type="checkbox"/>	Storeroom	<input checked="" type="checkbox"/>	<input type="checkbox"/>	<input type="checkbox"/>	<input checked="" type="checkbox"/>	Butt Hinge	Astragal	Flush Bolt		Surface

**MILLWORK AND SPECIALTY CASEWORK**

Storage Requirements:

**UPPER UNITS** U1  U2  U3  U4  U5  U6  U7  U8

**SHELF** S1

**LOWER UNITS** L1  L2  L3  L4  L5  L6  L7  L8  L9  L10  L11  L12

**RECEPTION/TRANSACTION COUNTER / CARE TEAM STATION DESK** TC1  TC2

**UTILITY SINK AND COUNTER UNIT** UC1

**FULL-HEIGHT CABINETS** C1  C2  C3  C4  C5

**Legend:**

Category	Min. Length (mm)	Motorized Adjustable Height	Standing Height	Specialty Casework
3	6000	<input type="checkbox"/>	<input type="checkbox"/>	<input type="checkbox"/>

**FINISHES**

Full-height Cabinet:	Plastic Laminate
Upper Millwork:	Plastic Laminate
Countertop:	Solid Surfacing
Lower Millwork:	Plastic Laminate
Shelf:	

Remarks: Provide (2) ceiling lifts, one over the parallel bar, one over the plinth.

**MECHANICAL REQUIREMENTS**

<b>PLUMBING</b> (Quantity) Hand Hygiene Sink: <input type="text" value="1"/> Lavatory: <input type="text"/> Kitchen Sink: <input type="text"/> Seamless Kitchen Sink: <input type="text"/> Utility / Process Sink: <input type="text"/> Scrub Sink: <input type="text"/> Floor Sink: <input type="text"/> Plumbing Remarks: <input type="text"/>	Other Fixtures: <input type="checkbox"/> Shower <input type="checkbox"/> Tub <input type="checkbox"/> Ice Maker <input type="checkbox"/> Water Closet <input type="checkbox"/> Instantaneous Hot Water <input type="checkbox"/> Eyewash Station <input type="checkbox"/> Eyewash/Shower Station <input type="checkbox"/> Emergency Shower <input type="checkbox"/> Flush Rim Sink <input type="checkbox"/> Floor Drain <input type="checkbox"/> Water Bottle Refill Station Other: <input type="text"/>	<b>MED / NON-MED GASES</b> (Quantity) Oxygen: <input type="text" value="3"/> Medical Air: <input type="text" value="3"/> Medical Vacuum: <input type="text" value="3"/> Nitrous Oxide: <input type="text"/> CO2: <input type="text"/> AGSS: <input type="text"/> Nitrogen: <input type="text"/> Laboratory Air: <input type="text"/> Laboratory Vacuum: <input type="text"/> Utility Compressed Air: <input type="text"/> Gas Remarks: Provide (1) set of medical gases located at the plinth. Other two sets distributed around room
---	--	--

**Appendix 1B Minimum Room Requirements**

Room Name:

Program Number(s):

1. B2.10	7.	13.	19.	25.	31.	37.	43.
2.	8.	14.	20.	26.	32.	38.	44.
3.	9.	15.	21.	27.	33.	39.	45.
4.	10.	16.	22.	28.	34.	40.	46.
5.	11.	17.	23.	29.	35.	41.	47.
6.	12.	18.	24.	30.	36.	42.	48.

**ARCHITECTURAL REQUIREMENTS**

<b>WALL AND CEILING</b> Wall Material: <input type="text" value="ARGB 1.2m AFF, GB above"/> Finish: <input type="text" value="PT"/> Ceiling Material: <input type="text" value="ACT"/> Finish: <input type="text" value="PF"/>	<b>WALL PROTECTION</b> Type: <input type="text" value="ESRP"/> <input checked="" type="checkbox"/> Corner Guards <input type="checkbox"/> Hand Rails <input type="checkbox"/> Bed Bumper / Locator Height: <input type="text" value="1600 mm"/> <input type="checkbox"/> Crash Rails <input type="checkbox"/> Chair Rail	<b>GLAZING</b> <input type="checkbox"/> Interior Glazing	<b>FLOORING TYPES</b> Material: <input type="text" value="WSVF"/> Base: <input type="text" value="FCB"/>	<b>ROOM ACCESSORIES</b> <input type="checkbox"/> Coat Hooks <input type="checkbox"/> Ceiling Lift <input type="checkbox"/> Magnetic Whiteboard <input type="checkbox"/> Mirror <input type="checkbox"/> Infant Change Table <input type="checkbox"/> Privacy Curtain
--	--	---	---	--

- LEGEND:**
- WALL AND CEILING LEGEND:**
- AC Architectural Ceiling
  - ACT Acoustic Ceiling Tile
  - ACT-C Cleanroom
  - ARGB Abuse-Resistant Gypsum Board
  - GB Gypsum Board
  - IRGB Impact-Resistant Gypsum Board
  - KLCT Kitchen Lay-in Ceiling Tile
  - MMRGB Moisture and Mould-Resistant Gypsum Board
  - SACT Security Acoustic Ceiling Tile
- WALL FINISHES LEGEND:**
- EWC Epoxy Wall Coating
  - HPC High Performance Coating
  - PT Paint
- CEILING FINISHES LEGEND:**
- ECC Epoxy Ceiling Coating
  - HPC High Performance Coating
  - PF Prefinished
  - PT Paint
- WALL PROTECTION LEGEND:**
- ESRP Extruded Semi-Rigid PVCu Panel
  - FRL Fibre Reinforced Laminate
  - FRP Fibreglass Reinforced Plastic
  - PVV Protective Vinyl Wallcovering
  - RHIS Rigid High Impact Sheet
  - WSSP Wetwall Solid Surface Panel
  - WVV Wetroom Vinyl Wallcovering
- FLOOR FINISHES LEGEND:**
- CFS Concrete Floor Sealer
  - EFC Epoxy Floor Coating
  - PFC Polyurethane Floor Coating
  - RAF Rubber Athletic Flooring
  - RSF Rubber Sheet Flooring
  - SCF Seamless Cushioned Flooring
  - SDRF Static-Dissipative Rubber Sheet Flooring
  - SDVF Static-Dissipative Vinyl Sheet Flooring
  - VSF Vinyl Sheet Flooring
  - WSVF Wetroom Safety Vinyl Sheet Flooring
- FLOOR BASE LEGEND:**
- FCB Flash Cove Base
  - RB Rubber Base
  - SCF Seamless Cushioned Flooring

**DOORS**

Types:

Type	Qty	Size (mm)	Material	Finish	Side Lt.	Blinds	Protect.	Privacy Film	Function	Card Reader	Mag Lock	Auto Opener	Hold Open	Hinges	Accessory 1	Accessory 2	Accessory 3	Closer
A	1	1220 x 2135	Hollow Metal	Paint	<input type="checkbox"/>	<input type="checkbox"/>	2 High	<input type="checkbox"/>	Storeroom	<input checked="" type="checkbox"/>	<input type="checkbox"/>	<input type="checkbox"/>	<input checked="" type="checkbox"/>	Butt Hinge				Surface

Door Remarks:  Security Grille  Anti-barricade strategy



**MECHANICAL REQUIREMENTS**

<b>PLUMBING</b> (Quantity) Hand Hygiene Sink: <input type="text"/> Lavatory: <input type="text"/> Kitchen Sink: <input type="text"/> Seamless Kitchen Sink: <input type="text"/> Utility / Process Sink: <input type="text"/> Scrub Sink: <input type="text"/> Floor Sink: <input type="text"/> Plumbing Remarks: <input type="text"/>	Other Fixtures: <input type="checkbox"/> Shower <input type="checkbox"/> Eyewash Station <input type="checkbox"/> Tub <input type="checkbox"/> Eyewash/Shower Station <input type="checkbox"/> Ice Maker <input type="checkbox"/> Emergency Shower <input type="checkbox"/> Water Closet <input type="checkbox"/> Flush Rim Sink <input type="checkbox"/> Instantaneous Hot Water <input type="checkbox"/> Floor Drain <input type="checkbox"/> <input type="checkbox"/> Water Bottle Refill Station Other: <input type="text"/>	<b>MED / NON-MED GASES</b> (Quantity) Oxygen: <input type="text"/> Medical Air: <input type="text"/> Medical Vacuum: <input type="text"/> Nitrous Oxide: <input type="text"/> CO2: <input type="text"/> AGSS: <input type="text"/> Nitrogen: <input type="text"/> Laboratory Air: <input type="text"/> Laboratory Vacuum: <input type="text"/> Utility Compressed Air: <input type="text"/> Gas Remarks: <input type="text"/>
---	---	---

**Appendix 1B Minimum Room Requirements**

Room Name:

Program Number(s):

1.	B4.05b	7.		13.		19.		25.		31.		37.		43.
2.		8.		14.		20.		26.		32.		38.		44.
3.		9.		15.		21.		27.		33.		39.		45.
4.		10.		16.		22.		28.		34.		40.		46.
5.		11.		17.		23.		29.		35.		41.		47.
6.		12.		18.		24.		30.		36.		42.		48.

**ARCHITECTURAL REQUIREMENTS**

<b>WALL AND CEILING</b> Wall Material: <input type="text" value="ARGB 1.2m AFF, GB above"/> Finish: <input type="text" value="PT"/> Ceiling Material: <input type="text" value="ACT"/> Finish: <input type="text" value="PF"/>		<b>WALL PROTECTION</b> Type: <input type="text" value="RHIS"/> <input checked="" type="checkbox"/> Corner Guards <input type="checkbox"/> Hand Rails <input type="checkbox"/> Bed Bumper / Locator Height: <input type="text" value="2185 mm"/> <input checked="" type="checkbox"/> Crash Rails <input type="checkbox"/> Chair Rail		<b>GLAZING</b> <input type="checkbox"/> Interior Glazing		<b>FLOORING TYPES</b> Material: <input type="text" value="VSF"/> Base: <input type="text" value="FCB"/>		<b>ROOM ACCESSORIES</b> <input type="checkbox"/> Coat Hooks <input type="checkbox"/> Ceiling Lift <input checked="" type="checkbox"/> Magnetic Whiteboard <input type="checkbox"/> Mirror <input type="checkbox"/> Infant Change Table <input type="checkbox"/> Privacy Curtain	
--	--	---	--	---	--	--	--	---	--

- LEGEND:**
- WALL AND CEILING LEGEND:**
- AC Architectural Ceiling
  - ACT Acoustic Ceiling Tile
  - ACT-C Cleanroom
  - ARGB Abuse-Resistant Gypsum Board
  - GB Gypsum Board
  - IRGB Impact-Resistant Gypsum Board
  - KLCT Kitchen Lay-in Ceiling Tile
  - MMRGB Moisture and Mould-Resistant Gypsum Board
  - SACT Security Acoustic Ceiling Tile
- WALL FINISHES LEGEND:**
- EWC Epoxy Wall Coating
  - HPC High Performance Coating
  - PT Paint
- CEILING FINISHES LEGEND:**
- ECC Epoxy Ceiling Coating
  - HPC High Performance Coating
  - PF Prefinished
  - PT Paint
- WALL PROTECTION LEGEND:**
- ESRP Extruded Semi-Rigid PVCu Panel
  - FRL Fibre Reinforced Laminate
  - FRP Fibreglass Reinforced Plastic
  - PVV Protective Vinyl Wallcovering
  - RHIS Rigid High Impact Sheet
  - WSSP Wetwall Solid Surface Panel
  - WVV Wetroom Vinyl Wallcovering
- FLOOR FINISHES LEGEND:**
- CFS Concrete Floor Sealer
  - EFC Epoxy Floor Coating
  - PFC Polyurethane Floor Coating
  - RAF Rubber Athletic Flooring
  - RSF Rubber Sheet Flooring
  - SCF Seamless Cushioned Flooring
  - SDRF Static-Dissipative Rubber Sheet Flooring
  - SDVF Static-Dissipative Vinyl Sheet Flooring
  - VSF Vinyl Sheet Flooring
  - WSVF Wetroom Safety Vinyl Sheet Flooring
- FLOOR BASE LEGEND:**
- FCB Flash Cove Base
  - RB Rubber Base
  - SCF Seamless Cushioned Flooring

**DOORS**

Types:

Note: for Type F doors, the door panels will be approximately 465/1065 unless otherwise required by the Authority

Door Remarks:  Security Grille  Anti-barricade strategy

Type	Qty	Size (mm)	Material	Finish	Side Lt.	Blinds	Protect.	Privacy Film	Function	Card Reader	Mag Lock	Auto Opener	Hold Open	Hinges	Accessory 1	Accessory 2	Accessory 3	Closer
F2	1	1650 x 2135	Solid Core	FRL	<input type="checkbox"/>	<input type="checkbox"/>	2 High	<input type="checkbox"/>	Storeroom	<input checked="" type="checkbox"/>	<input type="checkbox"/>	<input type="checkbox"/>	<input checked="" type="checkbox"/>	Butt Hinge	Astragal	Flush Bolt		Surface

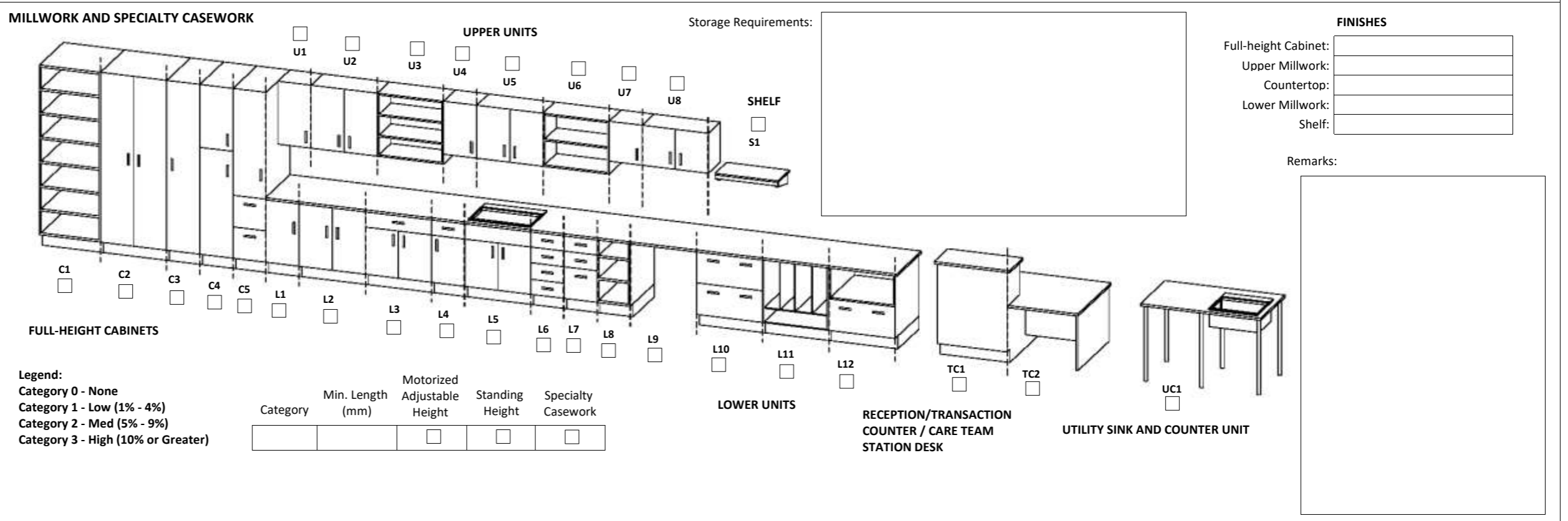

**MECHANICAL REQUIREMENTS**

<b>PLUMBING</b> (Quantity) Hand Hygiene Sink: <input type="text"/> Lavatory: <input type="text"/> Kitchen Sink: <input type="text"/> Seamless Kitchen Sink: <input type="text"/> Utility / Process Sink: <input type="text"/> Scrub Sink: <input type="text"/> Floor Sink: <input type="text"/> Plumbing Remarks: <input type="text"/>		Other Fixtures: <input type="checkbox"/> Shower <input type="checkbox"/> Tub <input type="checkbox"/> Ice Maker <input type="checkbox"/> Water Closet <input type="checkbox"/> Instantaneous Hot Water <input type="checkbox"/> Eyewash Station <input type="checkbox"/> Eyewash/Shower Station <input type="checkbox"/> Emergency Shower <input type="checkbox"/> Flush Rim Sink <input type="checkbox"/> Floor Drain <input type="checkbox"/> Water Bottle Refill Station Other <input type="text"/>		<b>MED / NON-MED GASES</b> (Quantity) Oxygen: <input type="text"/> Medical Air: <input type="text"/> Medical Vacuum: <input type="text"/> Nitrous Oxide: <input type="text"/> CO2: <input type="text"/> AGSS: <input type="text"/> Nitrogen: <input type="text"/> Laboratory Air: <input type="text"/> Laboratory Vacuum: <input type="text"/> Utility Compressed Air: <input type="text"/> Gas Remarks: <input type="text"/>	
--	--	---	--	---	--



**Appendix 1B Minimum Room Requirements**

Room Name:

Program Number(s):

1. B1.11	7.	13.	19.	25.	31.	37.	43.
2. B2.15	8.	14.	20.	26.	32.	38.	44.
3. B3.14	9.	15.	21.	27.	33.	39.	45.
4.	10.	16.	22.	28.	34.	40.	46.
5.	11.	17.	23.	29.	35.	41.	47.
6.	12.	18.	24.	30.	36.	42.	48.

**ARCHITECTURAL REQUIREMENTS**

<b>WALL AND CEILING</b> Wall Material: <input type="text" value="ARGB 1.2m AFF, GB above"/> Finish: <input type="text" value="PT"/> Ceiling Material: <input type="text" value="ACT"/> Finish: <input type="text" value="PF"/>	<b>WALL PROTECTION</b> Type: <input type="text" value="PVW"/> <input checked="" type="checkbox"/> Corner Guards <input type="checkbox"/> Hand Rails <input type="checkbox"/> Bed Bumper / Locator Height: <input type="text" value="1350 mm"/> <input type="checkbox"/> Crash Rails <input checked="" type="checkbox"/> Chair Rail	<b>GLAZING</b> <input checked="" type="checkbox"/> Interior Glazing	<b>FLOORING TYPES</b> Material: <input type="text" value="VSF"/> Base: <input type="text" value="RB"/>	<b>ROOM ACCESSORIES</b> <input type="checkbox"/> Coat Hooks <input type="checkbox"/> Ceiling Lift <input checked="" type="checkbox"/> Magnetic Whiteboard <input type="checkbox"/> Mirror <input type="checkbox"/> Infant Change Table <input type="checkbox"/> Privacy Curtain
--	--	--	---	---

- LEGEND:**
- WALL AND CEILING LEGEND:**
- AC Architectural Ceiling
  - ACT Acoustic Ceiling Tile
  - ACT-C Cleanroom
  - ARGB Abuse-Resistant Gypsum Board
  - GB Gypsum Board
  - IRGB Impact-Resistant Gypsum Board
  - KLCT Kitchen Lay-in Ceiling Tile
  - MMRGB Moisture and Mould-Resistant Gypsum Board
  - SACT Security Acoustic Ceiling Tile
- WALL FINISHES LEGEND:**
- EWC Epoxy Wall Coating
  - HPC High Performance Coating
  - PT Paint
- CEILING FINISHES LEGEND:**
- ECC Epoxy Ceiling Coating
  - HPC High Performance Coating
  - PF Prefinished
  - PT Paint
- WALL PROTECTION LEGEND:**
- ESRP Extruded Semi-Rigid PVCu Panel
  - FRL Fibre Reinforced Laminate
  - FRP Fibreglass Reinforced Plastic
  - PVW Protective Vinyl Wallcovering
  - RHIS Rigid High Impact Sheet
  - WSSP Wetwall Solid Surface Panel
  - WVV Wetroom Vinyl Wallcovering
- FLOOR FINISHES LEGEND:**
- CFS Concrete Floor Sealer
  - EFC Epoxy Floor Coating
  - PFC Polyurethane Floor Coating
  - RAF Rubber Athletic Flooring
  - RSF Rubber Sheet Flooring
  - SCF Seamless Cushioned Flooring
  - SDRF Static-Dissipative Rubber Sheet Flooring
  - SDVF Static-Dissipative Vinyl Sheet Flooring
  - VSF Vinyl Sheet Flooring
  - WSVF Wetroom Safety Vinyl Sheet Flooring
- FLOOR BASE LEGEND:**
- FCB Flash Cove Base
  - RB Rubber Base
  - SCF Seamless Cushioned Flooring

**DOORS**

Types:

Type	Qty	Size (mm)	Material	Finish	Side Lt.	Blinds	Protect.	Privacy Film	Function	Card Reader	Mag Lock	Auto Opener	Hold Open	Hinges	Accessory 1	Accessory 2	Accessory 3	Closer
B	1	915 x 2135	Solid Core	FRL	<input type="checkbox"/>	<input type="checkbox"/>	2 High	<input type="checkbox"/>	Push/Pull	<input type="checkbox"/>	<input type="checkbox"/>	<input type="checkbox"/>	<input type="checkbox"/>	Butt Hinge				Surface

Door Remarks:  Security Grille  Anti-barricade strategy



**MECHANICAL REQUIREMENTS**

<b>PLUMBING</b> (Quantity) Hand Hygiene Sink: <input type="text"/> Lavatory: <input type="text"/> Kitchen Sink: <input type="text"/> Seamless Kitchen Sink: <input type="text"/> Utility / Process Sink: <input type="text"/> Scrub Sink: <input type="text"/> Floor Sink: <input type="text"/> Plumbing Remarks: <input type="text"/>	Other Fixtures: <input type="checkbox"/> Shower <input type="checkbox"/> Eyewash Station <input type="checkbox"/> Tub <input type="checkbox"/> Eyewash/Shower Station <input type="checkbox"/> Ice Maker <input type="checkbox"/> Emergency Shower <input type="checkbox"/> Water Closet <input type="checkbox"/> Flush Rim Sink <input type="checkbox"/> Instantaneous Hot Water <input type="checkbox"/> Floor Drain <input type="checkbox"/> <input type="checkbox"/> Water Bottle Refill Station Other: <input type="text"/>	<b>MED / NON-MED GASES</b> (Quantity) Oxygen: <input type="text"/> Medical Air: <input type="text"/> Medical Vacuum: <input type="text"/> Nitrous Oxide: <input type="text"/> CO2: <input type="text"/> AGSS: <input type="text"/> Nitrogen: <input type="text"/> Laboratory Air: <input type="text"/> Laboratory Vacuum: <input type="text"/> Utility Compressed Air: <input type="text"/> Gas Remarks: <input type="text"/>
---	---	---



---

# New Surrey Hospital & BC Cancer Centre

MINIMUM ROOM REQUIREMENTS

## C. Emergency

---

**Appendix 1B Minimum Room Requirements**

Room Name:

Program Number(s):

1. C3.09	7.	13.	19.	25.	31.	37.	43.
2.	8.	14.	20.	26.	32.	38.	44.
3.	9.	15.	21.	27.	33.	39.	45.
4.	10.	16.	22.	28.	34.	40.	46.
5.	11.	17.	23.	29.	35.	41.	47.
6.	12.	18.	24.	30.	36.	42.	48.

**ARCHITECTURAL REQUIREMENTS**

<b>WALL AND CEILING</b> Wall Material: <input type="text" value="ARGB 1.2m AFF, GB above"/> Finish: <input type="text" value="PT"/> Ceiling Material: <input type="text" value="ACT"/> Finish: <input type="text" value="PF"/>	<b>WALL PROTECTION</b> Type: <input type="text" value="PVW"/> <input checked="" type="checkbox"/> Corner Guards <input type="checkbox"/> Hand Rails <input type="checkbox"/> Bed Bumper / Locator Height: <input type="text" value="2185 mm"/> <input checked="" type="checkbox"/> Crash Rails <input type="checkbox"/> Chair Rail	<b>GLAZING</b> <input type="checkbox"/> Interior Glazing	<b>FLOORING TYPES</b> Material: <input type="text" value="VSF"/> Base: <input type="text" value="FCB"/>	<b>ROOM ACCESSORIES</b> <input type="checkbox"/> Coat Hooks <input type="checkbox"/> Ceiling Lift <input type="checkbox"/> Magnetic Whiteboard <input type="checkbox"/> Mirror <input type="checkbox"/> Infant Change Table <input type="checkbox"/> Privacy Curtain
--	--	---	--	--

- LEGEND:**
- WALL AND CEILING LEGEND:**
- AC Architectural Ceiling
  - ACT Acoustic Ceiling Tile
  - ACT-C Cleanroom
  - ARGB Abuse-Resistant Gypsum Board
  - GB Gypsum Board
  - IRGB Impact-Resistant Gypsum Board
  - KLCT Kitchen Lay-in Ceiling Tile
  - MMRGB Moisture and Mould-Resistant Gypsum Board
  - SACT Security Acoustic Ceiling Tile
- WALL FINISHES LEGEND:**
- EWC Epoxy Wall Coating
  - HPC High Performance Coating
  - PT Paint
- CEILING FINISHES LEGEND:**
- ECC Epoxy Ceiling Coating
  - HPC High Performance Coating
  - PF Prefinished
  - PT Paint
- WALL PROTECTION LEGEND:**
- ESRP Extruded Semi-Rigid PVCu Panel
  - FRL Fibre Reinforced Laminate
  - FRP Fibreglass Reinforced Plastic
  - PVW Protective Vinyl Wallcovering
  - RHIS Rigid High Impact Sheet
  - WSSP Wetwall Solid Surface Panel
  - WVV Wetroom Vinyl Wallcovering
- FLOOR FINISHES LEGEND:**
- CFS Concrete Floor Sealer
  - EFC Epoxy Floor Coating
  - PFC Polyurethane Floor Coating
  - RAF Rubber Athletic Flooring
  - RSF Rubber Sheet Flooring
  - SCF Seamless Cushioned Flooring
  - SDRF Static-Dissipative Rubber Sheet Flooring
  - SDVF Static-Dissipative Vinyl Sheet Flooring
  - VSF Vinyl Sheet Flooring
  - WSVF Wetroom Safety Vinyl Sheet Flooring
- FLOOR BASE LEGEND:**
- FCB Flash Cove Base
  - RB Rubber Base
  - SCF Seamless Cushioned Flooring

**DOORS**

Types:

Type	Qty	Size (mm)	Material	Finish	Side Lt.	Blinds	Protect.	Privacy Film	Function	Card Reader	Mag Lock	Auto Opener	Hold Open	Hinges	Accessory 1	Accessory 2	Accessory 3	Closer

Door Remarks:  Security Grille  Anti-barricade strategy

**MILLWORK AND SPECIALTY CASEWORK**

**UPPER UNITS** (U1-U8) **LOWER UNITS** (L1-L12) **RECEPTION/TRANSACTION COUNTER / CARE TEAM STATION DESK** (TC1-TC2) **UTILITY SINK AND COUNTER UNIT** (UC1)

Storage Requirements:

**FINISHES**

Full-height Cabinet:   
 Upper Millwork:   
 Countertop:   
 Lower Millwork:   
 Shelf:

Remarks:

Category	Min. Length (mm)	Motorized Adjustable Height	Standing Height	Specialty Casework
Category 0 - None				
Category 1 - Low (1% - 4%)				
Category 2 - Med (5% - 9%)				
Category 3 - High (10% or Greater)				

**MECHANICAL REQUIREMENTS**

<b>PLUMBING</b> (Quantity) Hand Hygiene Sink: <input type="text"/> Lavatory: <input type="text"/> Kitchen Sink: <input type="text"/> Seamless Kitchen Sink: <input type="text"/> Utility / Process Sink: <input type="text"/> Scrub Sink: <input type="text"/> Floor Sink: <input type="text"/> Plumbing Remarks: <input type="text"/>	Other Fixtures: <input type="checkbox"/> Shower <input type="checkbox"/> Eyewash Station <input type="checkbox"/> Tub <input type="checkbox"/> Eyewash/Shower Station <input type="checkbox"/> Ice Maker <input type="checkbox"/> Emergency Shower <input type="checkbox"/> Water Closet <input type="checkbox"/> Flush Rim Sink <input type="checkbox"/> Instantaneous Hot Water <input type="checkbox"/> Floor Drain <input type="checkbox"/> <input type="checkbox"/> Water Bottle Refill Station Other <input type="text"/>	<b>MED / NON-MED GASES</b> (Quantity) Oxygen: <input type="text"/> Medical Air: <input type="text"/> Medical Vacuum: <input type="text"/> Nitrous Oxide: <input type="text"/> CO2: <input type="text"/> AGSS: <input type="text"/> Nitrogen: <input type="text"/> Laboratory Air: <input type="text"/> Laboratory Vacuum: <input type="text"/> Utility Compressed Air: <input type="text"/> Gas Remarks: <input type="text"/>
---	--	---

**Appendix 1B Minimum Room Requirements**

Room Name:

Program Number(s):

1. C4.07	7.	13.	19.	25.	31.	37.	43.
2.	8.	14.	20.	26.	32.	38.	44.
3.	9.	15.	21.	27.	33.	39.	45.
4.	10.	16.	22.	28.	34.	40.	46.
5.	11.	17.	23.	29.	35.	41.	47.
6.	12.	18.	24.	30.	36.	42.	48.

**ARCHITECTURAL REQUIREMENTS**

<b>WALL AND CEILING</b> Wall Material: <input type="text" value="ARGB 1.2m AFF, GB above"/> Finish: <input type="text" value="PT"/> Ceiling Material: <input type="text" value="ACT"/> Finish: <input type="text" value="PF"/>	<b>WALL PROTECTION</b> Type: <input type="text" value="PVW"/> <input checked="" type="checkbox"/> Corner Guards <input type="checkbox"/> Hand Rails <input type="checkbox"/> Bed Bumper / Locator Height: <input type="text" value="2185 mm"/> <input checked="" type="checkbox"/> Crash Rails <input type="checkbox"/> Chair Rail	<b>GLAZING</b> <input type="checkbox"/> Interior Glazing	<b>FLOORING TYPES</b> Material: <input type="text" value="VSF"/> Base: <input type="text" value="FCB"/>	<b>ROOM ACCESSORIES</b> <input type="checkbox"/> Coat Hooks <input type="checkbox"/> Ceiling Lift <input type="checkbox"/> Magnetic Whiteboard <input type="checkbox"/> Mirror <input type="checkbox"/> Infant Change Table <input type="checkbox"/> Privacy Curtain
--	--	---	--	--

- LEGEND:**
- WALL AND CEILING LEGEND:**
- AC Architectural Ceiling
  - ACT Acoustic Ceiling Tile
  - ACT-C Cleanroom
  - ARGB Abuse-Resistant Gypsum Board
  - GB Gypsum Board
  - IRGB Impact-Resistant Gypsum Board
  - KLCT Kitchen Lay-in Ceiling Tile
  - MMRGB Moisture and Mould-Resistant Gypsum Board
  - SACT Security Acoustic Ceiling Tile
- WALL FINISHES LEGEND:**
- EWC Epoxy Wall Coating
  - HPC High Performance Coating
  - PT Paint
- CEILING FINISHES LEGEND:**
- ECC Epoxy Ceiling Coating
  - HPC High Performance Coating
  - PF Prefinished
  - PT Paint
- WALL PROTECTION LEGEND:**
- ESRP Extruded Semi-Rigid PVCu Panel
  - FRL Fibre Reinforced Laminate
  - FRP Fibreglass Reinforced Plastic
  - PVW Protective Vinyl Wallcovering
  - RHIS Rigid High Impact Sheet
  - WSSP Wetwall Solid Surface Panel
  - WVV Wetroom Vinyl Wallcovering
- FLOOR FINISHES LEGEND:**
- CFS Concrete Floor Sealer
  - EFC Epoxy Floor Coating
  - PFC Polyurethane Floor Coating
  - RAF Rubber Athletic Flooring
  - RSF Rubber Sheet Flooring
  - SCF Seamless Cushioned Flooring
  - SDRF Static-Dissipative Rubber Sheet Flooring
  - SDVF Static-Dissipative Vinyl Sheet Flooring
  - VSF Vinyl Sheet Flooring
  - WSVF Wetroom Safety Vinyl Sheet Flooring
- FLOOR BASE LEGEND:**
- FCB Flash Cove Base
  - RB Rubber Base
  - SCF Seamless Cushioned Flooring

**DOORS**

Types:

Type	Qty	Size (mm)	Material	Finish	Side Lt.	Blinds	Protect.	Privacy Film	Function	Card Reader	Mag Lock	Auto Opener	Hold Open	Hinges	Accessory 1	Accessory 2	Accessory 3	Closer

Door Remarks:  Security Grille  Anti-barricade strategy

**MILLWORK AND SPECIALTY CASEWORK**

**UPPER UNITS** (U1-U8) **LOWER UNITS** (L1-L12) **RECEPTION/TRANSACTION COUNTER / CARE TEAM STATION DESK** (TC1-TC2) **UTILITY SINK AND COUNTER UNIT** (UC1)

Storage Requirements:

**FINISHES**

Full-height Cabinet:   
 Upper Millwork:   
 Countertop:   
 Lower Millwork:   
 Shelf:

Remarks:

**Legend:**

Category	Min. Length (mm)	Motorized Adjustable Height	Standing Height	Specialty Casework
Category 0 - None				
Category 1 - Low (1% - 4%)				
Category 2 - Med (5% - 9%)				
Category 3 - High (10% or Greater)				

**MECHANICAL REQUIREMENTS**

<b>PLUMBING</b> (Quantity) Hand Hygiene Sink: <input type="text"/> Lavatory: <input type="text"/> Kitchen Sink: <input type="text"/> Seamless Kitchen Sink: <input type="text"/> Utility / Process Sink: <input type="text"/> Scrub Sink: <input type="text"/> Floor Sink: <input type="text"/> Plumbing Remarks: <input type="text"/>	Other Fixtures: <input type="checkbox"/> Shower <input type="checkbox"/> Tub <input type="checkbox"/> Ice Maker <input type="checkbox"/> Water Closet <input type="checkbox"/> Instantaneous Hot Water <input type="checkbox"/> Eyewash Station <input type="checkbox"/> Eyewash/Shower Station <input type="checkbox"/> Emergency Shower <input type="checkbox"/> Flush Rim Sink <input type="checkbox"/> Floor Drain <input type="checkbox"/> Water Bottle Refill Station Other: <input type="text"/>	<b>MED / NON-MED GASES</b> (Quantity) Oxygen: <input type="text"/> Medical Air: <input type="text"/> Medical Vacuum: <input type="text"/> Nitrous Oxide: <input type="text"/> CO2: <input type="text"/> AGSS: <input type="text"/> Nitrogen: <input type="text"/> Laboratory Air: <input type="text"/> Laboratory Vacuum: <input type="text"/> Utility Compressed Air: <input type="text"/> Gas Remarks: <input type="text"/>
---	--	---

**Appendix 1B Minimum Room Requirements**

Room Name:

Program Number(s):

1. C3.08	7.	13.	19.	25.	31.	37.	43.
2.	8.	14.	20.	26.	32.	38.	44.
3.	9.	15.	21.	27.	33.	39.	45.
4.	10.	16.	22.	28.	34.	40.	46.
5.	11.	17.	23.	29.	35.	41.	47.
6.	12.	18.	24.	30.	36.	42.	48.

**ARCHITECTURAL REQUIREMENTS**

<b>WALL AND CEILING</b> Wall Material: <input type="text" value="ARGB 1.2m AFF, GB above"/> Finish: <input type="text" value="PT"/> Ceiling Material: <input type="text" value="ACT"/> Finish: <input type="text" value="PF"/>	<b>WALL PROTECTION</b> Type: <input type="text" value="PVW"/> <input checked="" type="checkbox"/> Corner Guards <input type="checkbox"/> Hand Rails <input type="checkbox"/> Bed Bumper / Locator Height: <input type="text" value="2185 mm"/> <input checked="" type="checkbox"/> Crash Rails <input type="checkbox"/> Chair Rail	<b>GLAZING</b> <input type="checkbox"/> Interior Glazing	<b>FLOORING TYPES</b> Material: <input type="text" value="VSF"/> Base: <input type="text" value="FCB"/>	<b>ROOM ACCESSORIES</b> <input type="checkbox"/> Coat Hooks <input type="checkbox"/> Ceiling Lift <input type="checkbox"/> Magnetic Whiteboard <input type="checkbox"/> Mirror <input type="checkbox"/> Infant Change Table <input type="checkbox"/> Privacy Curtain
--	--	---	--	--

- LEGEND:**
- WALL AND CEILING LEGEND:**
- AC Architectural Ceiling
  - ACT Acoustic Ceiling Tile
  - ACT-C Cleanroom
  - ARGB Abuse-Resistant Gypsum Board
  - GB Gypsum Board
  - IRGB Impact-Resistant Gypsum Board
  - KLCT Kitchen Lay-in Ceiling Tile
  - MMRGB Moisture and Mould-Resistant Gypsum Board
  - SACT Security Acoustic Ceiling Tile
- WALL FINISHES LEGEND:**
- EWC Epoxy Wall Coating
  - HPC High Performance Coating
  - PT Paint
- CEILING FINISHES LEGEND:**
- ECC Epoxy Ceiling Coating
  - HPC High Performance Coating
  - PF Prefinished
  - PT Paint
- WALL PROTECTION LEGEND:**
- ESRP Extruded Semi-Rigid PVCu Panel
  - FRL Fibre Reinforced Laminate
  - FRP Fibreglass Reinforced Plastic
  - PVW Protective Vinyl Wallcovering
  - RHIS Rigid High Impact Sheet
  - WSSP Wetwall Solid Surface Panel
  - WVV Wetroom Vinyl Wallcovering
- FLOOR FINISHES LEGEND:**
- CFS Concrete Floor Sealer
  - EFC Epoxy Floor Coating
  - PFC Polyurethane Floor Coating
  - RAF Rubber Athletic Flooring
  - RSF Rubber Sheet Flooring
  - SCF Seamless Cushioned Flooring
  - SDRF Static-Dissipative Rubber Sheet Flooring
  - SDVF Static-Dissipative Vinyl Sheet Flooring
  - VSF Vinyl Sheet Flooring
  - WSVF Wetroom Safety Vinyl Sheet Flooring
- FLOOR BASE LEGEND:**
- FCB Flash Cove Base
  - RB Rubber Base
  - SCF Seamless Cushioned Flooring

**DOORS**

Types:

Type	Qty	Size (mm)	Material	Finish	Side Lt	Blinds	Protect	Privacy Film	Function	Card Reader	Mag Lock	Auto Opener	Hold Open	Hinges	Accessory 1	Accessory 2	Accessory 3	Closer

Door Remarks:  Security Grille  Anti-barricade strategy

**MILLWORK AND SPECIALTY CASEWORK**

**UPPER UNITS** (U1-U8) **LOWER UNITS** (L1-L12) **RECEPTION/TRANSACTION COUNTER / CARE TEAM STATION DESK** (TC1-TC2) **UTILITY SINK AND COUNTER UNIT** (UC1)

Storage Requirements:

**FINISHES**

Full-height Cabinet:   
 Upper Millwork:   
 Countertop:   
 Lower Millwork:   
 Shelf:

Remarks:

**Legend:**

Category	Min. Length (mm)	Motorized Adjustable Height	Standing Height	Specialty Casework
Category 0 - None				
Category 1 - Low (1% - 4%)				
Category 2 - Med (5% - 9%)				
Category 3 - High (10% or Greater)				

**MECHANICAL REQUIREMENTS**

<b>PLUMBING</b> (Quantity) Hand Hygiene Sink: <input type="text"/> Lavatory: <input type="text"/> Kitchen Sink: <input type="text"/> Seamless Kitchen Sink: <input type="text"/> Utility / Process Sink: <input type="text"/> Scrub Sink: <input type="text"/> Floor Sink: <input type="text"/> Plumbing Remarks: <input type="text"/>	Other Fixtures: <input type="checkbox"/> Shower <input type="checkbox"/> Tub <input type="checkbox"/> Ice Maker <input type="checkbox"/> Water Closet <input type="checkbox"/> Instantaneous Hot Water <input type="checkbox"/> Eyewash Station <input type="checkbox"/> Eyewash/Shower Station <input type="checkbox"/> Emergency Shower <input type="checkbox"/> Flush Rim Sink <input type="checkbox"/> Floor Drain <input type="checkbox"/> Water Bottle Refill Station Other: <input type="text"/>	<b>MED / NON-MED GASES</b> (Quantity) Oxygen: <input type="text"/> Medical Air: <input type="text"/> Medical Vacuum: <input type="text"/> Nitrous Oxide: <input type="text"/> CO2: <input type="text"/> AGSS: <input type="text"/> Nitrogen: <input type="text"/> Laboratory Air: <input type="text"/> Laboratory Vacuum: <input type="text"/> Utility Compressed Air: <input type="text"/> Gas Remarks: <input type="text"/>
---	--	---



**Appendix 1B Minimum Room Requirements**

Room Name:

Program Number(s):

1.	C2.10	7.		13.		19.		25.		31.		37.		43.
2.		8.		14.		20.		26.		32.		38.		44.
3.		9.		15.		21.		27.		33.		39.		45.
4.		10.		16.		22.		28.		34.		40.		46.
5.		11.		17.		23.		29.		35.		41.		47.
6.		12.		18.		24.		30.		36.		42.		48.

**ARCHITECTURAL REQUIREMENTS**

<b>WALL AND CEILING</b> Wall Material: <input type="text" value="ARGB 1.2m AFF, GB above"/> Finish: <input type="text" value="PT"/> Ceiling Material: <input type="text" value="ACT"/> Finish: <input type="text" value="PF"/>		<b>WALL PROTECTION</b> Type: <input type="text" value="ESRP"/> <input checked="" type="checkbox"/> Corner Guards <input type="checkbox"/> Hand Rails <input type="checkbox"/> Bed Bumper / Locator Height: <input type="text" value="2185 mm"/> <input type="checkbox"/> Crash Rails <input type="checkbox"/> Chair Rail			<b>GLAZING</b> <input checked="" type="checkbox"/> Interior Glazing		<b>FLOORING TYPES</b> Material: <input type="text" value="VSF"/> Base: <input type="text" value="FCB"/>		<b>ROOM ACCESSORIES</b> <input checked="" type="checkbox"/> Coat Hooks <input type="checkbox"/> Ceiling Lift <input type="checkbox"/> Magnetic Whiteboard <input type="checkbox"/> Mirror <input type="checkbox"/> Infant Change Table <input type="checkbox"/> Privacy Curtain		
--	--	--	--	--	--	--	--	--	---	--	--

- LEGEND:**
- WALL AND CEILING LEGEND:**
- AC Architectural Ceiling
  - ACT Acoustic Ceiling Tile
  - ACT-C Cleanroom
  - ARGB Abuse-Resistant Gypsum Board
  - GB Gypsum Board
  - IRGB Impact-Resistant Gypsum Board
  - KLCT Kitchen Lay-in Ceiling Tile
  - MMRGB Moisture and Mould-Resistant Gypsum Board
  - SACT Security Acoustic Ceiling Tile
- WALL FINISHES LEGEND:**
- EWC Epoxy Wall Coating
  - HPC High Performance Coating
  - PT Paint
- CEILING FINISHES LEGEND:**
- ECC Epoxy Ceiling Coating
  - HPC High Performance Coating
  - PF Prefinished
  - PT Paint
- WALL PROTECTION LEGEND:**
- ESRP Extruded Semi-Rigid PVCu Panel
  - FRL Fibre Reinforced Laminate
  - FRP Fibreglass Reinforced Plastic
  - PVV Protective Vinyl Wallcovering
  - RHIS Rigid High Impact Sheet
  - WSSP Wetwall Solid Surface Panel
  - WVV Wetroom Vinyl Wallcovering
- FLOOR FINISHES LEGEND:**
- CFS Concrete Floor Sealer
  - EFC Epoxy Floor Coating
  - PFC Polyurethane Floor Coating
  - RAF Rubber Athletic Flooring
  - RSF Rubber Sheet Flooring
  - SCF Seamless Cushioned Flooring
  - SDRF Static-Dissipative Rubber Sheet Flooring
  - SDVF Static-Dissipative Vinyl Sheet Flooring
  - VSF Vinyl Sheet Flooring
  - WSVF Wetroom Safety Vinyl Sheet Flooring
- FLOOR BASE LEGEND:**
- FCB Flash Cove Base
  - RB Rubber Base
  - SCF Seamless Cushioned Flooring

**DOORS**

Types:

Type	Qty	Size (mm)	Material	Finish	Side Lt.	Blinds	Protect.	Privacy Film	Function	Card Reader	Mag Lock	Auto Opener	Hold Open	Hinges	Accessory 1	Accessory 2	Accessory 3	Closer
B	1	915 x 2135	Solid Core	FRL	<input type="checkbox"/>	<input type="checkbox"/>	2 High	<input type="checkbox"/>	Push/Pull	<input type="checkbox"/>	<input checked="" type="checkbox"/>	<input type="checkbox"/>	<input type="checkbox"/>	Butt Hinge				Surface
B	1	915 x 2135	Solid Core	FRL	<input type="checkbox"/>	<input type="checkbox"/>	2 High	<input type="checkbox"/>	Storeroom	<input checked="" type="checkbox"/>	<input checked="" type="checkbox"/>	<input type="checkbox"/>	<input type="checkbox"/>	Butt Hinge				Surface

Door Remarks:  Security Grille  Anti-barricade strategy

**MILLWORK AND SPECIALTY CASEWORK**

Storage Requirements:

**FINISHES**

Full-height Cabinet:

Upper Millwork:

Countertop:

Lower Millwork:

Shelf:

Remarks:

**Legend:**

Category	Min. Length (mm)	Motorized Adjustable Height	Standing Height	Specialty Casework
Category 0 - None		<input type="checkbox"/>	<input type="checkbox"/>	<input type="checkbox"/>
Category 1 - Low (1% - 4%)		<input type="checkbox"/>	<input type="checkbox"/>	<input type="checkbox"/>
Category 2 - Med (5% - 9%)		<input type="checkbox"/>	<input type="checkbox"/>	<input type="checkbox"/>
Category 3 - High (10% or Greater)		<input type="checkbox"/>	<input type="checkbox"/>	<input type="checkbox"/>

**MECHANICAL REQUIREMENTS**

<b>PLUMBING</b> (Quantity)							<b>Other Fixtures:</b>							<b>MED / NON-MED GASES</b> (Quantity)															
Hand Hygiene Sink:	Lavatory:	Kitchen Sink:	Seamless Kitchen Sink:	Utility / Process Sink:	Scrub Sink:	Floor Sink:	<input type="checkbox"/> Shower	<input type="checkbox"/> Tub	<input type="checkbox"/> Ice Maker	<input type="checkbox"/> Water Closet	<input type="checkbox"/> Instantaneous Hot Water	<input type="checkbox"/> Eyewash Station	<input type="checkbox"/> Eyewash/Shower Station	<input type="checkbox"/> Emergency Shower	<input type="checkbox"/> Flush Rim Sink	<input type="checkbox"/> Floor Drain	<input type="checkbox"/> Water Bottle Refill Station	Oxygen:	Medical Air:	Medical Vacuum:	Nitrous Oxide:	CO2:	AGSS:	Nitrogen:	Laboratory Air:	Laboratory Vacuum:	Utility Compressed Air:		
1																													
Plumbing Remarks:							Other: <input type="text"/>							Gas Remarks: <input type="text"/>															

**Appendix 1B Minimum Room Requirements**

Room Name:

Program Number(s):

1.	C2.12	7.		13.		19.		25.		31.		37.		43.
2.		8.		14.		20.		26.		32.		38.		44.
3.		9.		15.		21.		27.		33.		39.		45.
4.		10.		16.		22.		28.		34.		40.		46.
5.		11.		17.		23.		29.		35.		41.		47.
6.		12.		18.		24.		30.		36.		42.		48.

**ARCHITECTURAL REQUIREMENTS**

<b>WALL AND CEILING</b> Wall Material: <input type="text" value="ARGB 1.2m AFF, GB above"/> Finish: <input type="text" value="PT"/> Ceiling Material: <input type="text" value="ACT"/> Finish: <input type="text" value="PF"/>		<b>WALL PROTECTION</b> Type: <input type="text" value="ESRP"/> <input checked="" type="checkbox"/> Corner Guards <input type="checkbox"/> Hand Rails <input type="checkbox"/> Bed Bumper / Locator Height: <input type="text" value="2185 mm"/> <input type="checkbox"/> Crash Rails <input type="checkbox"/> Chair Rail			<b>GLAZING</b> <input checked="" type="checkbox"/> Interior Glazing		<b>FLOORING TYPES</b> Material: <input type="text" value="VSF"/> Base: <input type="text" value="FCB"/>		<b>ROOM ACCESSORIES</b> <input checked="" type="checkbox"/> Coat Hooks <input type="checkbox"/> Ceiling Lift <input type="checkbox"/> Magnetic Whiteboard <input type="checkbox"/> Mirror <input type="checkbox"/> Infant Change Table <input type="checkbox"/> Privacy Curtain		
--	--	--	--	--	--	--	--	--	---	--	--

- LEGEND:**
- WALL AND CEILING LEGEND:**
- AC Architectural Ceiling
  - ACT Acoustic Ceiling Tile
  - ACT-C Cleanroom
  - ARGB Abuse-Resistant Gypsum Board
  - GB Gypsum Board
  - IRGB Impact-Resistant Gypsum Board
  - KLCT Kitchen Lay-in Ceiling Tile
  - MMRGB Moisture and Mould-Resistant Gypsum Board
  - SACT Security Acoustic Ceiling Tile
- WALL FINISHES LEGEND:**
- EWC Epoxy Wall Coating
  - HPC High Performance Coating
  - PT Paint
- CEILING FINISHES LEGEND:**
- ECC Epoxy Ceiling Coating
  - HPC High Performance Coating
  - PF Prefinished
  - PT Paint
- WALL PROTECTION LEGEND:**
- ESRP Extruded Semi-Rigid PVCu Panel
  - FRL Fibre Reinforced Laminate
  - FRP Fibreglass Reinforced Plastic
  - PVV Protective Vinyl Wallcovering
  - RHIS Rigid High Impact Sheet
  - WSSP Wetwall Solid Surface Panel
  - WVV Wetroom Vinyl Wallcovering
- FLOOR FINISHES LEGEND:**
- CFS Concrete Floor Sealer
  - EFC Epoxy Floor Coating
  - PFC Polyurethane Floor Coating
  - RAF Rubber Athletic Flooring
  - RSF Rubber Sheet Flooring
  - SCF Seamless Cushioned Flooring
  - SDRF Static-Dissipative Rubber Sheet Flooring
  - SDVF Static-Dissipative Vinyl Sheet Flooring
  - VSF Vinyl Sheet Flooring
  - WSVF Wetroom Safety Vinyl Sheet Flooring
- FLOOR BASE LEGEND:**
- FCB Flash Cove Base
  - RB Rubber Base
  - SCF Seamless Cushioned Flooring

**DOORS**

Types:

Type	Qty	Size (mm)	Material	Finish	Side Lt.	Blinds	Protect.	Privacy Film	Function	Card Reader	Mag Lock	Auto Opener	Hold Open	Hinges	Accessory 1	Accessory 2	Accessory 3	Closer
B	1	915 x 2135	Solid Core	FRL	<input type="checkbox"/>	<input type="checkbox"/>	2 High	<input type="checkbox"/>	Push/Pull	<input type="checkbox"/>	<input checked="" type="checkbox"/>	<input type="checkbox"/>	<input type="checkbox"/>	Butt Hinge				Surface
B	1	915 x 2135	Solid Core	FRL	<input type="checkbox"/>	<input type="checkbox"/>	2 High	<input type="checkbox"/>	Storeroom	<input checked="" type="checkbox"/>	<input checked="" type="checkbox"/>	<input type="checkbox"/>	<input type="checkbox"/>	Butt Hinge				Surface

Door Remarks:  Security Grille  Anti-barricade strategy

**MILLWORK AND SPECIALTY CASEWORK**

Storage Requirements:

**UPPER UNITS** (U1-U8) **SHELF** (S1)

**FULL-HEIGHT CABINETS** (C1-C5) **LOWER UNITS** (L1-L12) **RECEPTION/TRANSACTION COUNTER / CARE TEAM STATION DESK** (TC1-TC2) **UTILITY SINK AND COUNTER UNIT** (UC1)

Category	Min. Length (mm)	Motorized Adjustable Height	Standing Height	Specialty Casework
Category 0 - None		<input type="checkbox"/>	<input type="checkbox"/>	<input type="checkbox"/>
Category 1 - Low (1% - 4%)		<input type="checkbox"/>	<input type="checkbox"/>	<input type="checkbox"/>
Category 2 - Med (5% - 9%)		<input type="checkbox"/>	<input type="checkbox"/>	<input type="checkbox"/>
Category 3 - High (10% or Greater)		<input type="checkbox"/>	<input type="checkbox"/>	<input type="checkbox"/>

**FINISHES**

Full-height Cabinet:   
 Upper Millwork:   
 Countertop:   
 Lower Millwork:   
 Shelf:

Remarks:

**MECHANICAL REQUIREMENTS**

<b>PLUMBING</b> (Quantity) Hygiene Sink: <input type="text" value="1"/> Lavatory: <input type="text"/> Kitchen Sink: <input type="text"/> Seamless Kitchen Sink: <input type="text"/> Utility / Process Sink: <input type="text"/> Scrub Sink: <input type="text"/> Floor Sink: <input type="text"/>							Other Fixtures: <input type="checkbox"/> Shower <input type="checkbox"/> Eyewash Station <input type="checkbox"/> Tub <input type="checkbox"/> Eyewash/Shower Station <input type="checkbox"/> Ice Maker <input type="checkbox"/> Emergency Shower <input type="checkbox"/> Water Closet <input type="checkbox"/> Flush Rim Sink <input type="checkbox"/> Instantaneous Hot Water <input type="checkbox"/> Floor Drain <input type="checkbox"/> Water Bottle Refill Station Other: <input type="text"/>				<b>MED / NON-MED GASES</b> (Quantity) Oxygen: <input type="text"/> Medical Air: <input type="text"/> Medical Vacuum: <input type="text"/> Nitrous Oxide: <input type="text"/> CO2: <input type="text"/> AGSS: <input type="text"/> Nitrogen: <input type="text"/> Laboratory Air: <input type="text"/> Laboratory Vacuum: <input type="text"/> Utility Compressed Air: <input type="text"/>					
Plumbing Remarks: <input type="text"/>											Gas Remarks: <input type="text"/>					

**Appendix 1B Minimum Room Requirements**

Room Name:

Program Number(s):

1.	C2.16	7.		13.		19.		25.		31.		37.		43.
2.		8.		14.		20.		26.		32.		38.		44.
3.		9.		15.		21.		27.		33.		39.		45.
4.		10.		16.		22.		28.		34.		40.		46.
5.		11.		17.		23.		29.		35.		41.		47.
6.		12.		18.		24.		30.		36.		42.		48.

**ARCHITECTURAL REQUIREMENTS**

<b>WALL AND CEILING</b> Wall Material: <input type="text" value="IRGB"/> Finish: <input type="text" value="PT"/> Ceiling Material: <input type="text" value="ACT"/> Finish: <input type="text" value="PF"/>	<b>WALL PROTECTION</b> Type: <input type="text"/> Height: <input type="text"/> <input type="checkbox"/> Corner Guards <input type="checkbox"/> Hand Rails <input type="checkbox"/> Bed Bumper / Locator <input type="checkbox"/> Crash Rails <input type="checkbox"/> Chair Rail	<b>GLAZING</b> <input checked="" type="checkbox"/> Interior Glazing	<b>FLOORING TYPES</b> Material: <input type="text" value="RSF"/> Base: <input type="text" value="FCB"/>	<b>ROOM ACCESSORIES</b> <input type="checkbox"/> Coat Hooks <input type="checkbox"/> Ceiling Lift <input type="checkbox"/> Magnetic Whiteboard <input type="checkbox"/> Mirror <input type="checkbox"/> Infant Change Table <input type="checkbox"/> Privacy Curtain
---	---	--	--	--

- LEGEND:**
- WALL AND CEILING LEGEND:**
- AC Architectural Ceiling
  - ACT Acoustic Ceiling Tile
  - ACT-C Cleanroom
  - ARGB Abuse-Resistant Gypsum Board
  - GB Gypsum Board
  - IRGB Impact-Resistant Gypsum Board
  - KLCT Kitchen Lay-in Ceiling Tile
  - MMRGB Moisture and Mould-Resistant Gypsum Board
  - SACT Security Acoustic Ceiling Tile
- WALL FINISHES LEGEND:**
- EWC Epoxy Wall Coating
  - HPC High Performance Coating
  - PT Paint
- CEILING FINISHES LEGEND:**
- ECC Epoxy Ceiling Coating
  - HPC High Performance Coating
  - PF Prefinished
  - PT Paint
- WALL PROTECTION LEGEND:**
- ESRP Extruded Semi-Rigid PVCu Panel
  - FRL Fibre Reinforced Laminate
  - FRP Fibreglass Reinforced Plastic
  - PVV Protective Vinyl Wallcovering
  - RHIS Rigid High Impact Sheet
  - WSSP Wetwall Solid Surface Panel
  - WVV Wetroom Vinyl Wallcovering
- FLOOR FINISHES LEGEND:**
- CFS Concrete Floor Sealer
  - EFC Epoxy Floor Coating
  - PFC Polyurethane Floor Coating
  - RAF Rubber Athletic Flooring
  - RSF Rubber Sheet Flooring
  - SCF Seamless Cushioned Flooring
  - SDRF Static-Dissipative Rubber Sheet Flooring
  - SDVF Static-Dissipative Vinyl Sheet Flooring
  - VSF Vinyl Sheet Flooring
  - WSVF Wetroom Safety Vinyl Sheet Flooring
- FLOOR BASE LEGEND:**
- FCB Flash Cove Base
  - RB Rubber Base
  - SCF Seamless Cushioned Flooring

**DOORS**

Types:

Type	Qty	Size (mm)	Material	Finish	Side Lt.	Blinds	Protect.	Privacy Film	Function	Card Reader	Mag Lock	Auto Opener	Hold Open	Hinges	Accessory 1	Accessory 2	Accessory 3	Closer
C	1	1220 x 2135	Solid Core	FRL	<input type="checkbox"/>	<input type="checkbox"/>	2 High	<input type="checkbox"/>	Storeroom	<input checked="" type="checkbox"/>	<input type="checkbox"/>	<input type="checkbox"/>	<input type="checkbox"/>	Continuous	Safety Stop			

Door Remarks:  Security Grille  Anti-barricade strategy

Door to outswing 180 degrees. Ligature resistant hardware

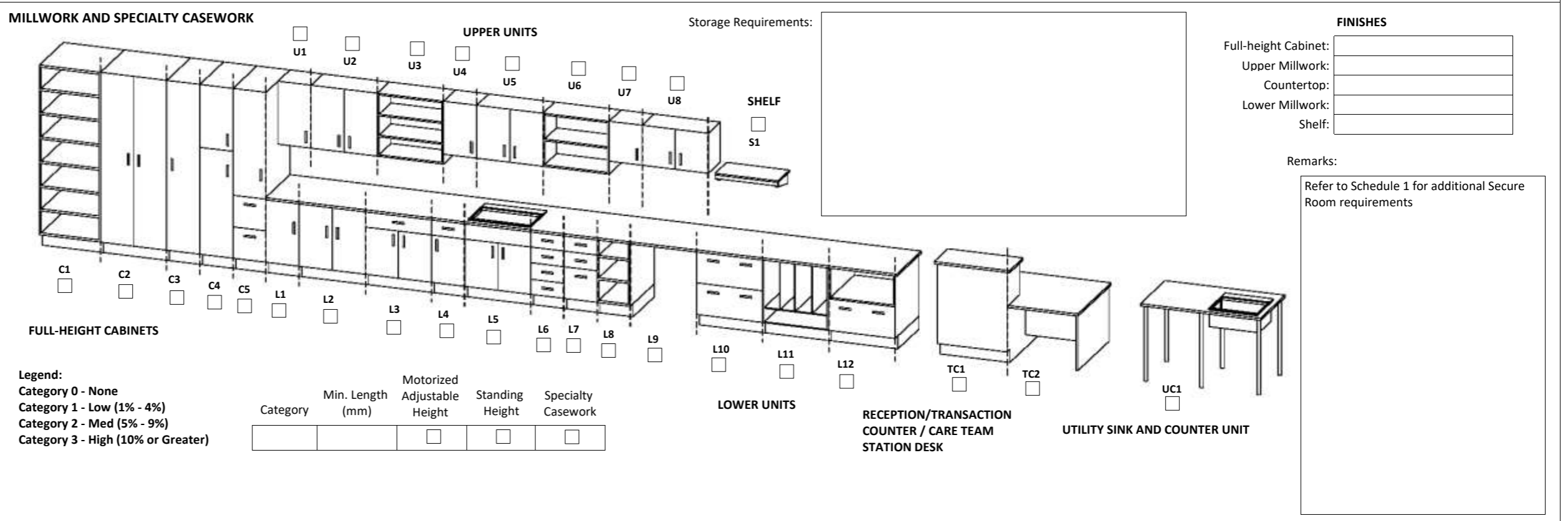

**MECHANICAL REQUIREMENTS**

<b>PLUMBING</b> (Quantity) Hand Hygiene Sink: <input type="text" value="1"/> Lavatory: <input type="text"/> Kitchen Sink: <input type="text"/> Seamless Kitchen Sink: <input type="text"/> Utility / Process Sink: <input type="text"/> Scrub Sink: <input type="text"/> Floor Sink: <input type="text"/> Plumbing Remarks: Emergency Water Shut off to be located with convenient by staff.	Other Fixtures: <input type="checkbox"/> Shower <input type="checkbox"/> Tub <input type="checkbox"/> Ice Maker <input type="checkbox"/> Water Closet <input type="checkbox"/> Instantaneous Hot Water <input type="checkbox"/> Eyewash Station <input type="checkbox"/> Eyewash/Shower Station <input type="checkbox"/> Emergency Shower <input type="checkbox"/> Flush Rim Sink <input type="checkbox"/> Floor Drain <input type="checkbox"/> Water Bottle Refill Station Other: <input type="text"/>	<b>MED / NON-MED GASES</b> (Quantity) Oxygen: <input type="text"/> Medical Air: <input type="text"/> Medical Vacuum: <input type="text"/> Nitrous Oxide: <input type="text"/> CO2: <input type="text"/> AGSS: <input type="text"/> Nitrogen: <input type="text"/> Laboratory Air: <input type="text"/> Laboratory Vacuum: <input type="text"/> Utility Compressed Air: <input type="text"/> Gas Remarks: <input type="text"/>
--	--	---



**Appendix 1B Minimum Room Requirements**

Room Name:

Program Number(s):

1. C3.02	7.	13.	19.	25.	31.	37.	43.
2.	8.	14.	20.	26.	32.	38.	44.
3.	9.	15.	21.	27.	33.	39.	45.
4.	10.	16.	22.	28.	34.	40.	46.
5.	11.	17.	23.	29.	35.	41.	47.
6.	12.	18.	24.	30.	36.	42.	48.

**ARCHITECTURAL REQUIREMENTS**

<b>WALL AND CEILING</b> Wall Material: <input type="text" value="ARGB 1.2m AFF, GB above"/> Finish: <input type="text" value="PT"/> Ceiling Material: <input type="text" value="GB"/> Finish: <input type="text" value="PT"/>	<b>WALL PROTECTION</b> Type: <input type="text" value="ESRP"/> <input checked="" type="checkbox"/> Corner Guards <input type="checkbox"/> Hand Rails <input type="checkbox"/> Bed Bumper / Locator Height: <input type="text" value="2185 mm"/> <input type="checkbox"/> Crash Rails <input type="checkbox"/> Chair Rail	<b>GLAZING</b> <input checked="" type="checkbox"/> Interior Glazing	<b>FLOORING TYPES</b> Material: <input type="text" value="VSF"/> Base: <input type="text" value="FCB"/>	<b>ROOM ACCESSORIES</b> <input checked="" type="checkbox"/> Coat Hooks <input type="checkbox"/> Ceiling Lift <input type="checkbox"/> Magnetic Whiteboard <input type="checkbox"/> Mirror <input type="checkbox"/> Infant Change Table <input type="checkbox"/> Privacy Curtain
---	--	--	--	---

- LEGEND:**
- WALL AND CEILING LEGEND:**
- AC Architectural Ceiling
  - ACT Acoustic Ceiling Tile
  - ACT-C Cleanroom
  - ARGB Abuse-Resistant Gypsum Board
  - GB Gypsum Board
  - IRGB Impact-Resistant Gypsum Board
  - KLCT Kitchen Lay-in Ceiling Tile
  - MMRGB Moisture and Mould-Resistant Gypsum Board
  - SACT Security Acoustic Ceiling Tile
- WALL FINISHES LEGEND:**
- EWC Epoxy Wall Coating
  - HPC High Performance Coating
  - PT Paint
- CEILING FINISHES LEGEND:**
- ECC Epoxy Ceiling Coating
  - HPC High Performance Coating
  - PF Prefinished
  - PT Paint
- WALL PROTECTION LEGEND:**
- ESRP Extruded Semi-Rigid PVCu Panel
  - FRL Fibre Reinforced Laminate
  - FRP Fibreglass Reinforced Plastic
  - PVV Protective Vinyl Wallcovering
  - RHIS Rigid High Impact Sheet
  - WSSP Wetwall Solid Surface Panel
  - WVV Wetroom Vinyl Wallcovering
- FLOOR FINISHES LEGEND:**
- CFS Concrete Floor Sealer
  - EFC Epoxy Floor Coating
  - PFC Polyurethane Floor Coating
  - RAF Rubber Athletic Flooring
  - RSF Rubber Sheet Flooring
  - SCF Seamless Cushioned Flooring
  - SDRF Static-Dissipative Rubber Sheet Flooring
  - SDVF Static-Dissipative Vinyl Sheet Flooring
  - VSF Vinyl Sheet Flooring
  - WSVF Wetroom Safety Vinyl Sheet Flooring
- FLOOR BASE LEGEND:**
- FCB Flash Cove Base
  - RB Rubber Base
  - SCF Seamless Cushioned Flooring

**DOORS**

Types:

Type	Qty	Size (mm)	Material	Finish	Side Lt.	Blinds	Protect.	Privacy Film	Function	Card Reader	Mag Lock	Auto Opener	Hold Open	Hinges	Accessory 1	Accessory 2	Accessory 3	Closer
H	2	1340 x 2135	Aluminum	Prefinished	<input type="checkbox"/>	<input type="checkbox"/>		<input type="checkbox"/>		<input type="checkbox"/>	<input type="checkbox"/>	<input checked="" type="checkbox"/>	<input type="checkbox"/>		Elec. Strike			

Door Remarks:

Security Grille  
 Anti-barricade strategy

**MILLWORK AND SPECIALTY CASEWORK**

**UPPER UNITS** (U1-U8) **LOWER UNITS** (L1-L12) **RECEPTION/TRANSACTION COUNTER / CARE TEAM STATION DESK** (TC1-TC2) **UTILITY SINK AND COUNTER UNIT** (UC1)

Storage Requirements:

**FINISHES**

Full-height Cabinet:   
 Upper Millwork:   
 Countertop:   
 Lower Millwork:   
 Shelf:

Remarks:

**Legend:**

Category	Min. Length (mm)	Motorized Adjustable Height	Standing Height	Specialty Casework
Category 0 - None				
Category 1 - Low (1% - 4%)		<input type="checkbox"/>	<input type="checkbox"/>	<input type="checkbox"/>
Category 2 - Med (5% - 9%)				
Category 3 - High (10% or Greater)				

**MECHANICAL REQUIREMENTS**

<b>PLUMBING</b> (Quantity) Hand Hygiene Sink: <input type="text"/> Lavatory: <input type="text"/> Kitchen Sink: <input type="text"/> Seamless Kitchen Sink: <input type="text"/> Utility / Process Sink: <input type="text"/> Scrub Sink: <input type="text"/> Floor Sink: <input type="text"/> Plumbing Remarks: <input type="text"/>	Other Fixtures: <input type="checkbox"/> Shower <input type="checkbox"/> Eyewash Station <input type="checkbox"/> Tub <input type="checkbox"/> Eyewash/Shower Station <input type="checkbox"/> Ice Maker <input type="checkbox"/> Emergency Shower <input type="checkbox"/> Water Closet <input type="checkbox"/> Flush Rim Sink <input type="checkbox"/> Instantaneous Hot Water <input type="checkbox"/> Floor Drain <input type="checkbox"/> <input type="checkbox"/> Water Bottle Refill Station Other <input type="text"/>	<b>MED / NON-MED GASES</b> (Quantity) Oxygen: <input type="text"/> Medical Air: <input type="text"/> Medical Vacuum: <input type="text"/> Nitrous Oxide: <input type="text"/> CO2: <input type="text"/> AGSS: <input type="text"/> Nitrogen: <input type="text"/> Laboratory Air: <input type="text"/> Laboratory Vacuum: <input type="text"/> Utility Compressed Air: <input type="text"/> Gas Remarks: <input type="text"/>
---	--	---



**Appendix 1B Minimum Room Requirements**

Room Name:

Program Number(s):

1. C3.07	7.	13.	19.	25.	31.	37.	43.
2. C4.03	8.	14.	20.	26.	32.	38.	44.
3.	9.	15.	21.	27.	33.	39.	45.
4.	10.	16.	22.	28.	34.	40.	46.
5.	11.	17.	23.	29.	35.	41.	47.
6.	12.	18.	24.	30.	36.	42.	48.

**ARCHITECTURAL REQUIREMENTS**

<b>WALL AND CEILING</b> Wall Material: <input type="text" value="ARGB 1.2m AFF, GB above"/> Finish: <input type="text" value="PT"/> Ceiling Material: <input type="text" value="ACT"/> Finish: <input type="text" value="PF"/>		<b>WALL PROTECTION</b> Type: <input type="text" value="PVW"/> <input checked="" type="checkbox"/> Corner Guards <input type="checkbox"/> Hand Rails <input type="checkbox"/> Bed Bumper / Locator Height: <input type="text" value="1600 mm"/> <input type="checkbox"/> Crash Rails <input checked="" type="checkbox"/> Chair Rail		<b>GLAZING</b> <input type="checkbox"/> Interior Glazing		<b>FLOORING TYPES</b> Material: <input type="text" value="VSF"/> Base: <input type="text" value="FCB"/>		<b>ROOM ACCESSORIES</b> <input checked="" type="checkbox"/> Coat Hooks <input type="checkbox"/> Ceiling Lift <input type="checkbox"/> Magnetic Whiteboard <input type="checkbox"/> Mirror <input type="checkbox"/> Infant Change Table <input checked="" type="checkbox"/> Privacy Curtain	
--	--	--	--	---	--	--	--	--	--

- LEGEND:**
- WALL AND CEILING LEGEND:**
- AC Architectural Ceiling
  - ACT Acoustic Ceiling Tile
  - ACT-C Cleanroom
  - ARGB Abuse-Resistant Gypsum Board
  - GB Gypsum Board
  - IRGB Impact-Resistant Gypsum Board
  - KLCT Kitchen Lay-in Ceiling Tile
  - MMRGB Moisture and Mould-Resistant Gypsum Board
  - SACT Security Acoustic Ceiling Tile
- WALL FINISHES LEGEND:**
- EWC Epoxy Wall Coating
  - HPC High Performance Coating
  - PT Paint
- CEILING FINISHES LEGEND:**
- ECC Epoxy Ceiling Coating
  - HPC High Performance Coating
  - PF Prefinished
  - PT Paint
- WALL PROTECTION LEGEND:**
- ESRP Extruded Semi-Rigid PVCu Panel
  - FRL Fibre Reinforced Laminate
  - FRP Fibreglass Reinforced Plastic
  - PVW Protective Vinyl Wallcovering
  - RHIS Rigid High Impact Sheet
  - WSSP Wetwall Solid Surface Panel
  - WVV Wetroom Vinyl Wallcovering
- FLOOR FINISHES LEGEND:**
- CFS Concrete Floor Sealer
  - EFC Epoxy Floor Coating
  - PFC Polyurethane Floor Coating
  - RAF Rubber Athletic Flooring
  - RSF Rubber Sheet Flooring
  - SCF Seamless Cushioned Flooring
  - SDRF Static-Dissipative Rubber Sheet Flooring
  - SDVF Static-Dissipative Vinyl Sheet Flooring
  - VSF Vinyl Sheet Flooring
  - WSVF Wetroom Safety Vinyl Sheet Flooring
- FLOOR BASE LEGEND:**
- FCB Flash Cove Base
  - RB Rubber Base
  - SCF Seamless Cushioned Flooring

**DOORS**

Types:

Type	Qty	Size (mm)	Material	Finish	Side Lt.	Blinds	Protect.	Privacy Film	Function	Card Reader	Mag Lock	Auto Opener	Hold Open	Hinges	Accessory 1	Accessory 2	Accessory 3	Closer

Door Remarks:  Security Grille  Anti-barricade strategy



**MECHANICAL REQUIREMENTS**

<b>PLUMBING</b> (Quantity)		Hand Hygiene Sink: <input type="text" value="1"/> Lavatory: <input type="text"/> Kitchen Sink: <input type="text"/> Seamless Kitchen Sink: <input type="text"/> Utility / Process Sink: <input type="text"/> Scrub Sink: <input type="text"/> Floor Sink: <input type="text"/>							Other Fixtures: <input type="checkbox"/> Shower <input type="checkbox"/> Tub <input type="checkbox"/> Ice Maker <input type="checkbox"/> Water Closet <input type="checkbox"/> Instantaneous Hot Water				<input type="checkbox"/> Eyewash Station <input type="checkbox"/> Eyewash/Shower Station <input type="checkbox"/> Emergency Shower <input type="checkbox"/> Flush Rim Sink <input type="checkbox"/> Floor Drain <input type="checkbox"/> Water Bottle Refill Station				<b>MED / NON-MED GASES</b> (Quantity)				
Plumbing Remarks: <input type="text"/>		Oxygen: <input type="text" value="1"/>		Medical Air: <input type="text" value="1"/>		Medical Vacuum: <input type="text" value="1"/>		Nitrous Oxide: <input type="text"/>		CO2: <input type="text"/>		AGSS: <input type="text"/>		Nitrogen: <input type="text"/>		Laboratory Air: <input type="text"/>		Laboratory Vacuum: <input type="text"/>		Utility Compressed Air: <input type="text"/>	
		Gas Remarks: <input type="text" value="Provide (1) set of medical gasses per bay to Patient's right."/>																			

**Appendix 1B Minimum Room Requirements**

Room Name:

Program Number(s):

1. C4.01	7.	13.	19.	25.	31.	37.	43.
2.	8.	14.	20.	26.	32.	38.	44.
3.	9.	15.	21.	27.	33.	39.	45.
4.	10.	16.	22.	28.	34.	40.	46.
5.	11.	17.	23.	29.	35.	41.	47.
6.	12.	18.	24.	30.	36.	42.	48.

**ARCHITECTURAL REQUIREMENTS**

<b>WALL AND CEILING</b> Wall Material: <input type="text" value="ARGB 1.2m AFF, GB above"/> Finish: <input type="text" value="PT"/> Ceiling Material: <input type="text" value="SACT"/> Finish: <input type="text" value="PT"/>	<b>WALL PROTECTION</b> Type: <input type="text" value="PVW"/> <input checked="" type="checkbox"/> Corner Guards <input type="checkbox"/> Hand Rails <input type="checkbox"/> Bed Bumper / Locator Height: <input type="text" value="1350 mm"/> <input type="checkbox"/> Crash Rails <input checked="" type="checkbox"/> Chair Rail	<b>GLAZING</b> <input checked="" type="checkbox"/> Interior Glazing	<b>FLOORING TYPES</b> Material: <input type="text" value="RSF"/> Base: <input type="text" value="FCB"/>	<b>ROOM ACCESSORIES</b> <input type="checkbox"/> Coat Hooks <input type="checkbox"/> Ceiling Lift <input checked="" type="checkbox"/> Magnetic Whiteboard <input type="checkbox"/> Mirror <input type="checkbox"/> Infant Change Table <input type="checkbox"/> Privacy Curtain
---	--	--	--	---

- LEGEND:**
- WALL AND CEILING LEGEND:**
- AC Architectural Ceiling
  - ACT Acoustic Ceiling Tile
  - ACT-C Cleanroom
  - ARGB Abuse-Resistant Gypsum Board
  - GB Gypsum Board
  - IRGB Impact-Resistant Gypsum Board
  - KLCT Kitchen Lay-in Ceiling Tile
  - MMRGB Moisture and Mould-Resistant Gypsum Board
  - SACT Security Acoustic Ceiling Tile
- WALL FINISHES LEGEND:**
- EWC Epoxy Wall Coating
  - HPC High Performance Coating
  - PT Paint
- CEILING FINISHES LEGEND:**
- ECC Epoxy Ceiling Coating
  - HPC High Performance Coating
  - PF Prefinished
  - PT Paint
- WALL PROTECTION LEGEND:**
- ESRP Extruded Semi-Rigid PVCu Panel
  - FRL Fibre Reinforced Laminate
  - FRP Fibreglass Reinforced Plastic
  - PVW Protective Vinyl Wallcovering
  - RHIS Rigid High Impact Sheet
  - WSSP Wetwall Solid Surface Panel
  - WVV Wetroom Vinyl Wallcovering
- FLOOR FINISHES LEGEND:**
- CFS Concrete Floor Sealer
  - EFC Epoxy Floor Coating
  - PFC Polyurethane Floor Coating
  - RAF Rubber Athletic Flooring
  - RSF Rubber Sheet Flooring
  - SCF Seamless Cushioned Flooring
  - SDRF Static-Dissipative Rubber Sheet Flooring
  - SDVF Static-Dissipative Vinyl Sheet Flooring
  - VSF Vinyl Sheet Flooring
  - WSVF Wetroom Safety Vinyl Sheet Flooring
- FLOOR BASE LEGEND:**
- FCB Flash Cove Base
  - RB Rubber Base
  - SCF Seamless Cushioned Flooring

**DOORS**

Types:

Type	Qty	Size (mm)	Material	Finish	Side Lt	Blinds	Protect	Privacy Film	Function	Card Reader	Mag Lock	Auto Opener	Hold Open	Hinges	Accessory 1	Accessory 2	Accessory 3	Closer
C	1	1220 x 2135	Solid Core	FRL	<input type="checkbox"/>	<input type="checkbox"/>	1 Low	<input type="checkbox"/>	Storeroom	<input checked="" type="checkbox"/>	<input type="checkbox"/>	<input type="checkbox"/>	<input type="checkbox"/>	Butt Hinge				Surface
C	1	915 x 2135	Solid Core	FRL	<input type="checkbox"/>	<input type="checkbox"/>	1 Low	<input type="checkbox"/>	Storeroom	<input checked="" type="checkbox"/>	<input type="checkbox"/>	<input type="checkbox"/>	<input type="checkbox"/>	Butt Hinge				Surface

Door Remarks:  Security Grille  Anti-barricade strategy

**MILLWORK AND SPECIALTY CASEWORK**

**UPPER UNITS** (U1-U8) **LOWER UNITS** (L1-L12) **RECEPTION/TRANSACTION COUNTER / CARE TEAM STATION DESK** (TC1-TC2) **UTILITY SINK AND COUNTER UNIT** (UC1)

Storage Requirements:

**FINISHES**

Full-height Cabinet:   
 Upper Millwork:   
 Countertop:   
 Lower Millwork:   
 Shelf:

Remarks:

**Legend:**

Category	Min. Length (mm)	Motorized Adjustable Height	Standing Height	Specialty Casework
Category 0 - None		<input type="checkbox"/>	<input type="checkbox"/>	<input type="checkbox"/>
Category 1 - Low (1% - 4%)		<input type="checkbox"/>	<input type="checkbox"/>	<input type="checkbox"/>
Category 2 - Med (5% - 9%)		<input type="checkbox"/>	<input type="checkbox"/>	<input type="checkbox"/>
Category 3 - High (10% or Greater)		<input type="checkbox"/>	<input type="checkbox"/>	<input type="checkbox"/>

**MECHANICAL REQUIREMENTS**

<b>PLUMBING</b> (Quantity) Hand Hygiene Sink: <input type="text"/> Lavatory: <input type="text"/> Kitchen Sink: <input type="text"/> Seamless Kitchen Sink: <input type="text"/> Utility / Process Sink: <input type="text"/> Scrub Sink: <input type="text"/> Floor Sink: <input type="text"/> Plumbing Remarks: <input type="text"/>	Other Fixtures: <input type="checkbox"/> Shower <input type="checkbox"/> Eyewash Station <input type="checkbox"/> Tub <input type="checkbox"/> Eyewash/Shower Station <input type="checkbox"/> Ice Maker <input type="checkbox"/> Emergency Shower <input type="checkbox"/> Water Closet <input type="checkbox"/> Flush Rim Sink <input type="checkbox"/> Instantaneous Hot Water <input type="checkbox"/> Floor Drain <input type="checkbox"/> <input type="checkbox"/> Water Bottle Refill Station Other <input type="text"/>	<b>MED / NON-MED GASES</b> (Quantity) Oxygen: <input type="text"/> Medical Air: <input type="text"/> Medical Vacuum: <input type="text"/> Nitrous Oxide: <input type="text"/> CO2: <input type="text"/> AGSS: <input type="text"/> Nitrogen: <input type="text"/> Laboratory Air: <input type="text"/> Laboratory Vacuum: <input type="text"/> Utility Compressed Air: <input type="text"/> Gas Remarks: <input type="text"/>
---	--	---

**Appendix 1B Minimum Room Requirements**

Room Name:

Program Number(s):

1. C2.02	7.	13.	19.	25.	31.	37.	43.
2.	8.	14.	20.	26.	32.	38.	44.
3.	9.	15.	21.	27.	33.	39.	45.
4.	10.	16.	22.	28.	34.	40.	46.
5.	11.	17.	23.	29.	35.	41.	47.
6.	12.	18.	24.	30.	36.	42.	48.

**ARCHITECTURAL REQUIREMENTS**

<b>WALL AND CEILING</b> Wall Material: <input type="text" value="ARGB 1.2m AFF, GB above"/> Finish: <input type="text" value="PT"/> Ceiling Material: <input type="text" value="SACT"/> Finish: <input type="text" value="PT"/>	<b>WALL PROTECTION</b> Type: <input type="text" value="PVW"/> <input checked="" type="checkbox"/> Corner Guards <input type="checkbox"/> Hand Rails <input type="checkbox"/> Bed Bumper / Locator Height: <input type="text" value="2185 mm"/> <input type="checkbox"/> Crash Rails <input checked="" type="checkbox"/> Chair Rail	<b>GLAZING</b> <input type="checkbox"/> Interior Glazing	<b>FLOORING TYPES</b> Material: <input type="text" value="VSF"/> Base: <input type="text" value="FCB"/>	<b>ROOM ACCESSORIES</b> <input type="checkbox"/> Coat Hooks <input type="checkbox"/> Ceiling Lift <input type="checkbox"/> Magnetic Whiteboard <input type="checkbox"/> Mirror <input type="checkbox"/> Infant Change Table <input type="checkbox"/> Privacy Curtain
---	--	---	--	--

- LEGEND:**
- WALL AND CEILING LEGEND:**
- AC Architectural Ceiling
  - ACT Acoustic Ceiling Tile
  - ACT-C Cleanroom
  - ARGB Abuse-Resistant Gypsum Board
  - GB Gypsum Board
  - IRGB Impact-Resistant Gypsum Board
  - KLCT Kitchen Lay-in Ceiling Tile
  - MMRGB Moisture and Mould-Resistant Gypsum Board
  - SACT Security Acoustic Ceiling Tile
- WALL FINISHES LEGEND:**
- EWC Epoxy Wall Coating
  - HPC High Performance Coating
  - PT Paint
- CEILING FINISHES LEGEND:**
- ECC Epoxy Ceiling Coating
  - HPC High Performance Coating
  - PF Prefinished
  - PT Paint
- WALL PROTECTION LEGEND:**
- ESRP Extruded Semi-Rigid PVCu Panel
  - FRL Fibre Reinforced Laminate
  - FRP Fibreglass Reinforced Plastic
  - PVW Protective Vinyl Wallcovering
  - RHIS Rigid High Impact Sheet
  - WSSP Wetwall Solid Surface Panel
  - WVV Wetroom Vinyl Wallcovering
- FLOOR FINISHES LEGEND:**
- CFS Concrete Floor Sealer
  - EFC Epoxy Floor Coating
  - PFC Polyurethane Floor Coating
  - RAF Rubber Athletic Flooring
  - RSF Rubber Sheet Flooring
  - SCF Seamless Cushioned Flooring
  - SDRF Static-Dissipative Rubber Sheet Flooring
  - SDVF Static-Dissipative Vinyl Sheet Flooring
  - VSF Vinyl Sheet Flooring
  - WSVF Wetroom Safety Vinyl Sheet Flooring
- FLOOR BASE LEGEND:**
- FCB Flash Cove Base
  - RB Rubber Base
  - SCF Seamless Cushioned Flooring

**DOORS**

Types:

Type	Qty	Size (mm)	Material	Finish	Side Lt.	Blinds	Protect.	Privacy Film	Function	Card Reader	Mag Lock	Auto Opener	Hold Open	Hinges	Accessory 1	Accessory 2	Accessory 3	Closer
B	1	1065 x 2135	Solid Core	FRL	<input type="checkbox"/>	<input type="checkbox"/>	1 Low	<input type="checkbox"/>	Passage	<input type="checkbox"/>	<input type="checkbox"/>	<input type="checkbox"/>	<input type="checkbox"/>	Cont. Double-Acting	Safety Stop			Surface

Door Remarks:  Security Grille  Anti-barricade strategy

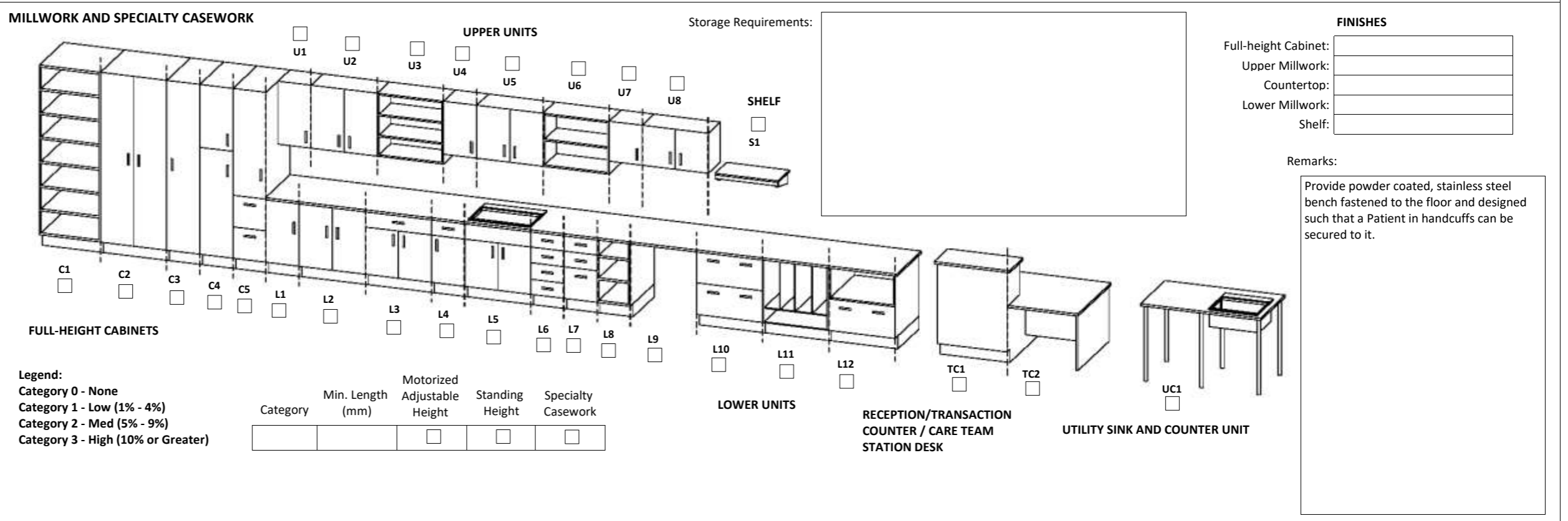

**MECHANICAL REQUIREMENTS**

<b>PLUMBING</b> (Quantity) Hand Hygiene Sink: <input type="text"/> Lavatory: <input type="text"/> Kitchen Sink: <input type="text"/> Seamless Kitchen Sink: <input type="text"/> Utility / Process Sink: <input type="text"/> Scrub Sink: <input type="text"/> Floor Sink: <input type="text"/> Plumbing Remarks: <input type="text"/>	Other Fixtures: <input type="checkbox"/> Shower <input type="checkbox"/> Eyewash Station <input type="checkbox"/> Tub <input type="checkbox"/> Eyewash/Shower Station <input type="checkbox"/> Ice Maker <input type="checkbox"/> Emergency Shower <input type="checkbox"/> Water Closet <input type="checkbox"/> Flush Rim Sink <input type="checkbox"/> Instantaneous Hot Water <input type="checkbox"/> Floor Drain <input type="checkbox"/> <input type="checkbox"/> Water Bottle Refill Station Other: <input type="text"/>	<b>MED / NON-MED GASES</b> (Quantity) Oxygen: <input type="text"/> Medical Air: <input type="text"/> Medical Vacuum: <input type="text"/> Nitrous Oxide: <input type="text"/> CO2: <input type="text"/> AGSS: <input type="text"/> Nitrogen: <input type="text"/> Laboratory Air: <input type="text"/> Laboratory Vacuum: <input type="text"/> Utility Compressed Air: <input type="text"/> Gas Remarks: <input type="text"/>
---	---	---



**Appendix 1B Minimum Room Requirements**

Room Name:

Program Number(s):

1. C2.08	7.	13.	19.	25.	31.	37.	43.
2.	8.	14.	20.	26.	32.	38.	44.
3.	9.	15.	21.	27.	33.	39.	45.
4.	10.	16.	22.	28.	34.	40.	46.
5.	11.	17.	23.	29.	35.	41.	47.
6.	12.	18.	24.	30.	36.	42.	48.

**ARCHITECTURAL REQUIREMENTS**

<b>WALL AND CEILING</b> Wall Material: <input type="text" value="ARGB 1.2m AFF, GB above"/> Finish: <input type="text" value="EWC"/> Ceiling Material: <input type="text" value="ACT"/> Finish: <input type="text" value="PF"/>	<b>WALL PROTECTION</b> Type: <input type="text" value="ESRP"/> <input checked="" type="checkbox"/> Corner Guards <input type="checkbox"/> Hand Rails <input type="checkbox"/> Bed Bumper / Locator Height: <input type="text" value="2185 mm"/> <input type="checkbox"/> Crash Rails <input type="checkbox"/> Chair Rail	<b>GLAZING</b> <input type="checkbox"/> Interior Glazing	<b>FLOORING TYPES</b> Material: <input type="text" value="WSVF"/> Base: <input type="text" value="FCB"/>	<b>ROOM ACCESSORIES</b> <input type="checkbox"/> Coat Hooks <input type="checkbox"/> Ceiling Lift <input checked="" type="checkbox"/> Magnetic Whiteboard <input type="checkbox"/> Mirror <input type="checkbox"/> Infant Change Table <input type="checkbox"/> Privacy Curtain
---	--	---	---	---

- LEGEND:**
- WALL AND CEILING LEGEND:**
- AC Architectural Ceiling
  - ACT Acoustic Ceiling Tile
  - ACT-C Cleanroom
  - ARGB Abuse-Resistant Gypsum Board
  - GB Gypsum Board
  - IRGB Impact-Resistant Gypsum Board
  - KLCT Kitchen Lay-in Ceiling Tile
  - MMRGB Moisture and Mould-Resistant Gypsum Board
  - SACT Security Acoustic Ceiling Tile
- WALL FINISHES LEGEND:**
- EWC Epoxy Wall Coating
  - HPC High Performance Coating
  - PT Paint
- CEILING FINISHES LEGEND:**
- ECC Epoxy Ceiling Coating
  - HPC High Performance Coating
  - PF Prefinished
  - PT Paint
- WALL PROTECTION LEGEND:**
- ESRP Extruded Semi-Rigid PVCu Panel
  - FRL Fibre Reinforced Laminate
  - FRP Fibreglass Reinforced Plastic
  - PVV Protective Vinyl Wallcovering
  - RHIS Rigid High Impact Sheet
  - WSSP Wetwall Solid Surface Panel
  - WVV Wetroom Vinyl Wallcovering
- FLOOR FINISHES LEGEND:**
- CFS Concrete Floor Sealer
  - EFC Epoxy Floor Coating
  - PFC Polyurethane Floor Coating
  - RAF Rubber Athletic Flooring
  - RSF Rubber Sheet Flooring
  - SCF Seamless Cushioned Flooring
  - SDRF Static-Dissipative Rubber Sheet Flooring
  - SDVF Static-Dissipative Vinyl Sheet Flooring
  - VSF Vinyl Sheet Flooring
  - WSVF Wetroom Safety Vinyl Sheet Flooring
- FLOOR BASE LEGEND:**
- FCB Flash Cove Base
  - RB Rubber Base
  - SCF Seamless Cushioned Flooring

**DOORS**

Types:

Note: for Type F doors, the door panels will be approximately 465/1065 unless otherwise required by the Authority

Door Remarks: Provide exit lock on exterior door (type A2 door) with no outside hardware, door to be opened from interior. Door release to be from observation alcove. Refer to Appendix 1A [Clinical Specifications and Functional Space Requirements] Section 2.3 - C. Emergency for door release information.

Type	Qty	Size (mm)	Material	Finish	Side Lt	Blinds	Protect	Privacy Film	Function	Card Reader	Mag Lock	Auto Opener	Hold Open	Hinges	Accessory 1	Accessory 2	Accessory 3	Closer
F2	1	1530 x 2135	Solid Core	FRL	<input type="checkbox"/>	<input type="checkbox"/>	2 High	<input type="checkbox"/>	Storeroom	<input checked="" type="checkbox"/>	<input type="checkbox"/>	<input type="checkbox"/>	<input checked="" type="checkbox"/>	Butt Hinge	Astragal	Flush Bolt		Surface
A2	1	1830 x 2135	Hollow Metal	Paint	<input type="checkbox"/>	<input type="checkbox"/>	2 High	<input type="checkbox"/>	Storeroom	<input checked="" type="checkbox"/>	<input type="checkbox"/>	<input type="checkbox"/>	<input checked="" type="checkbox"/>	Butt Hinge	Astragal	Flush Bolt		Surface

**MILLWORK AND SPECIALTY CASEWORK**

Storage Requirements:

**FINISHES**

Full-height Cabinet:

Upper Millwork:

Countertop:

Lower Millwork:

Shelf:

Remarks:

Category	Min. Length (mm)	Motorized Adjustable Height	Standing Height	Specialty Casework
Category 0 - None		<input type="checkbox"/>	<input type="checkbox"/>	<input type="checkbox"/>
Category 1 - Low (1% - 4%)		<input type="checkbox"/>	<input type="checkbox"/>	<input type="checkbox"/>
Category 2 - Med (5% - 9%)		<input type="checkbox"/>	<input type="checkbox"/>	<input type="checkbox"/>
Category 3 - High (10% or Greater)		<input type="checkbox"/>	<input type="checkbox"/>	<input type="checkbox"/>

**MECHANICAL REQUIREMENTS**

<b>PLUMBING</b> (Quantity) Hand Hygiene Sink: <input type="text"/> Lavatory: <input type="text"/> Kitchen Sink: <input type="text"/> Seamless Kitchen Sink: <input type="text"/> Utility / Process Sink: <input type="text"/> Scrub Sink: <input type="text"/> Floor Sink: <input type="text"/> Plumbing Remarks: <input type="text"/>	Other Fixtures: <input type="checkbox"/> Shower <input type="checkbox"/> Tub <input type="checkbox"/> Ice Maker <input type="checkbox"/> Water Closet <input type="checkbox"/> Instantaneous Hot Water <input type="checkbox"/> Eyewash Station <input checked="" type="checkbox"/> Eyewash/Shower Station <input type="checkbox"/> Emergency Shower <input type="checkbox"/> Flush Rim Sink <input checked="" type="checkbox"/> Floor Drain <input type="checkbox"/> Water Bottle Refill Station Other <input type="text"/>	<b>MED / NON-MED GASES</b> (Quantity) Oxygen: <input type="text" value="1"/> Medical Air: <input type="text" value="1"/> Medical Vacuum: <input type="text" value="1"/> Nitrous Oxide: <input type="text"/> CO2: <input type="text"/> AGSS: <input type="text"/> Nitrogen: <input type="text"/> Laboratory Air: <input type="text"/> Laboratory Vacuum: <input type="text"/> Utility Compressed Air: <input type="text"/> Gas Remarks: <input type="text"/>
---	--	---



**Appendix 1B Minimum Room Requirements**

Room Name:

Program Number(s):

1. C2.07	7.	13.	19.	25.	31.	37.	43.
2.	8.	14.	20.	26.	32.	38.	44.
3.	9.	15.	21.	27.	33.	39.	45.
4.	10.	16.	22.	28.	34.	40.	46.
5.	11.	17.	23.	29.	35.	41.	47.
6.	12.	18.	24.	30.	36.	42.	48.

**ARCHITECTURAL REQUIREMENTS**

<b>WALL AND CEILING</b> Wall Material: <input type="text"/> Ceiling Material: <input type="text"/> Finish: <input type="text"/> Finish: <input type="text"/>	<b>WALL PROTECTION</b> Type: <input type="text"/> Height: <input type="text"/> <input type="checkbox"/> Corner Guards <input type="checkbox"/> Hand Rails <input type="checkbox"/> Bed Bumper / Locator <input type="checkbox"/> Crash Rails <input type="checkbox"/> Chair Rail	<b>GLAZING</b> <input type="checkbox"/> Interior Glazing	<b>FLOORING TYPES</b> Material: <input type="text"/> Base: <input type="text"/>	<b>ROOM ACCESSORIES</b> <input type="checkbox"/> Coat Hooks <input type="checkbox"/> Ceiling Lift <input type="checkbox"/> Magnetic Whiteboard <input type="checkbox"/> Mirror <input type="checkbox"/> Infant Change Table <input type="checkbox"/> Privacy Curtain
--	--	---	--	--

- LEGEND:**
- WALL AND CEILING LEGEND:**
- AC Architectural Ceiling
  - ACT Acoustic Ceiling Tile
  - ACT-C Cleanroom
  - ARGB Abuse-Resistant Gypsum Board
  - GB Gypsum Board
  - IRGB Impact-Resistant Gypsum Board
  - KLCT Kitchen Lay-in Ceiling Tile
  - MMRGB Moisture and Mould-Resistant Gypsum Board
  - SACT Security Acoustic Ceiling Tile
- WALL FINISHES LEGEND:**
- EWC Epoxy Wall Coating
  - HPC High Performance Coating
  - PT Paint
- CEILING FINISHES LEGEND:**
- ECC Epoxy Ceiling Coating
  - HPC High Performance Coating
  - PF Prefinished
  - PT Paint
- WALL PROTECTION LEGEND:**
- ESRP Extruded Semi-Rigid PVCu Panel
  - FRL Fibre Reinforced Laminate
  - FRP Fibreglass Reinforced Plastic
  - PVV Protective Vinyl Wallcovering
  - RHIS Rigid High Impact Sheet
  - WSSP Wetwall Solid Surface Panel
  - WVV Wetroom Vinyl Wallcovering
- FLOOR FINISHES LEGEND:**
- CFS Concrete Floor Sealer
  - EFC Epoxy Floor Coating
  - PFC Polyurethane Floor Coating
  - RAF Rubber Athletic Flooring
  - RSF Rubber Sheet Flooring
  - SCF Seamless Cushioned Flooring
  - SDRF Static-Dissipative Rubber Sheet Flooring
  - SDVF Static-Dissipative Vinyl Sheet Flooring
  - VSF Vinyl Sheet Flooring
  - WSVF Wetroom Safety Vinyl Sheet Flooring
- FLOOR BASE LEGEND:**
- FCB Flash Cove Base
  - RB Rubber Base
  - SCF Seamless Cushioned Flooring

**DOORS**

Types:

Type:Qty:	Size (mm):	Material:	Finish:	Side Lt:	Blinds:	Protect.:	Privacy Film:	Function:	Card Reader:	Mag Lock:	Auto Opener:	Hold Open:	Hinges:	Accessory 1:	Accessory 2:	Accessory 3:	Closer:

Door Remarks:

Security Grille  
 Anti-barricade strategy

**MILLWORK AND SPECIALTY CASEWORK**

Storage Requirements:

**UPPER UNITS** (U1-U8)

**LOWER UNITS** (L1-L12)

**RECEPTION/TRANSACTION COUNTER / CARE TEAM STATION DESK** (TC1, TC2)

**UTILITY SINK AND COUNTER UNIT** (UC1)

**SHELF** (S1)

**FULL-HEIGHT CABINETS** (C1-C5)

**Legend:**

Category	Min. Length (mm)	Motorized Adjustable Height	Standing Height	Specialty Casework
Category 0 - None				
Category 1 - Low (1% - 4%)				
Category 2 - Med (5% - 9%)				
Category 3 - High (10% or Greater)				

**FINISHES**

Full-height Cabinet:   
 Upper Millwork:   
 Countertop:   
 Lower Millwork:   
 Shelf:

Remarks:

Refer to Schedule 1, Section 5.10 External Ambulance Canopy/Vehicle Bay for Decontamination Shower information

**MECHANICAL REQUIREMENTS**

<b>PLUMBING</b> (Quantity) Hygiene Sink: <input type="text"/> Lavatory: <input type="text"/> Kitchen Sink: <input type="text"/> Kitchen Sink: <input type="text"/> Process Sink: <input type="text"/> Scrub Sink: <input type="text"/> Floor Sink: <input type="text"/> Plumbing Remarks: <input type="text"/>	Other Fixtures: <input type="checkbox"/> Shower <input type="checkbox"/> Tub <input type="checkbox"/> Ice Maker <input type="checkbox"/> Water Closet <input type="checkbox"/> Instantaneous Hot Water <input type="checkbox"/> Ewewash Station <input type="checkbox"/> Ewewash/Shower Station <input checked="" type="checkbox"/> Emergency Shower <input type="checkbox"/> Flush Rim Sink <input checked="" type="checkbox"/> Floor Drain <input type="checkbox"/> Water Bottle Refill Station Other: <input type="text"/>	<b>MED / NON-MED GASES</b> (Quantity) Oxygen: <input type="text"/> Medical Air: <input type="text"/> Medical Vacuum: <input type="text"/> Nitrous Oxide: <input type="text"/> CO2: <input type="text"/> AGSS: <input type="text"/> Nitrogen: <input type="text"/> Laboratory Air: <input type="text"/> Laboratory Vacuum: <input type="text"/> Utility Compressed Air: <input type="text"/> Gas Remarks: <input type="text"/>
---	---	---

**Appendix 1B Minimum Room Requirements**

Room Name:

Program Number(s):

1. C4.06	7.	13.	19.	25.	31.	37.	43.
2.	8.	14.	20.	26.	32.	38.	44.
3.	9.	15.	21.	27.	33.	39.	45.
4.	10.	16.	22.	28.	34.	40.	46.
5.	11.	17.	23.	29.	35.	41.	47.
6.	12.	18.	24.	30.	36.	42.	48.

**ARCHITECTURAL REQUIREMENTS**

<b>WALL AND CEILING</b> Wall Material: <input type="text" value="ARGB 1.2m AFF, GB above"/> Finish: <input type="text" value="PT"/> Ceiling Material: <input type="text" value="ACT"/> Finish: <input type="text" value="PF"/>	<b>WALL PROTECTION</b> Type: <input type="text" value="PVW"/> <input checked="" type="checkbox"/> Corner Guards <input type="checkbox"/> Hand Rails <input type="checkbox"/> Bed Bumper / Locator Height: <input type="text" value="2185 mm"/> <input type="checkbox"/> Crash Rails <input type="checkbox"/> Chair Rail	<b>GLAZING</b> <input type="checkbox"/> Interior Glazing	<b>FLOORING TYPES</b> Material: <input type="text" value="VSF"/> Base: <input type="text" value="FCB"/>	<b>ROOM ACCESSORIES</b> <input checked="" type="checkbox"/> Coat Hooks <input checked="" type="checkbox"/> Ceiling Lift <input checked="" type="checkbox"/> Magnetic Whiteboard <input type="checkbox"/> Mirror <input type="checkbox"/> Infant Change Table <input checked="" type="checkbox"/> Privacy Curtain
--	---	---	--	--

- LEGEND:**
- WALL AND CEILING LEGEND:**
- AC Architectural Ceiling
  - ACT Acoustic Ceiling Tile
  - ACT-C Cleanroom
  - ARGB Abuse-Resistant Gypsum Board
  - GB Gypsum Board
  - IRGB Impact-Resistant Gypsum Board
  - KLCT Kitchen Lay-in Ceiling Tile
  - MMRGB Moisture and Mould-Resistant Gypsum Board
  - SACT Security Acoustic Ceiling Tile
- WALL FINISHES LEGEND:**
- EWC Epoxy Wall Coating
  - HPC High Performance Coating
  - PT Paint
- CEILING FINISHES LEGEND:**
- ECC Epoxy Ceiling Coating
  - HPC High Performance Coating
  - PF Prefinished
  - PT Paint
- WALL PROTECTION LEGEND:**
- ESRP Extruded Semi-Rigid PVCu Panel
  - FRL Fibre Reinforced Laminate
  - FRP Fibreglass Reinforced Plastic
  - PVW Protective Vinyl Wallcovering
  - RHIS Rigid High Impact Sheet
  - WSSP Wetwall Solid Surface Panel
  - WVV Wetroom Vinyl Wallcovering
- FLOOR FINISHES LEGEND:**
- CFS Concrete Floor Sealer
  - EFC Epoxy Floor Coating
  - PFC Polyurethane Floor Coating
  - RAF Rubber Athletic Flooring
  - RSF Rubber Sheet Flooring
  - SCF Seamless Cushioned Flooring
  - SDRF Static-Dissipative Rubber Sheet Flooring
  - SDVF Static-Dissipative Vinyl Sheet Flooring
  - VSF Vinyl Sheet Flooring
  - WSVF Wetroom Safety Vinyl Sheet Flooring
- FLOOR BASE LEGEND:**
- FCB Flash Cove Base
  - RB Rubber Base
  - SCF Seamless Cushioned Flooring

**DOORS**

Types:

Type	Qty	Size (mm)	Material	Finish	Side Lt.	Blinds	Protect.	Privacy Film	Function	Card Reader	Mag Lock	Auto Opener	Hold Open	Hinges	Accessory 1	Accessory 2	Accessory 3	Closer
H	1	1340 X 2135	Aluminum	Prefinished	<input type="checkbox"/>	<input type="checkbox"/>		<input type="checkbox"/>		<input type="checkbox"/>	<input type="checkbox"/>	<input type="checkbox"/>	<input type="checkbox"/>					

Door Remarks:  Security Grille  Anti-barricade strategy

**MILLWORK AND SPECIALTY CASEWORK**

**UPPER UNITS** (U1-U8) **LOWER UNITS** (L1-L12) **RECEPTION/TRANSACTION COUNTER / CARE TEAM STATION DESK** (TC1-TC2) **UTILITY SINK AND COUNTER UNIT** (UC1)

Storage Requirements:  SHELF (S1)

**FINISHES**

Full-height Cabinet:   
 Upper Millwork:   
 Countertop:   
 Lower Millwork:   
 Shelf:

Remarks: Refer to Schedule 1, Section 5.14 Interior Environment for Pediatric Design information

**MECHANICAL REQUIREMENTS**

<b>PLUMBING</b> (Quantity) Hand Hygiene Sink: <input type="text" value="1"/> Lavatory: <input type="text"/> Kitchen Sink: <input type="text"/> Kitchen Sink: <input type="text"/> Utility / Process Sink: <input type="text"/> Scrub Sink: <input type="text"/> Floor Sink: <input type="text"/> Plumbing Remarks: <input type="text"/>	Other Fixtures: <input type="checkbox"/> Shower <input type="checkbox"/> Tub <input type="checkbox"/> Ice Maker <input type="checkbox"/> Water Closet <input type="checkbox"/> Instantaneous Hot Water <input type="checkbox"/> Eyewash Station <input type="checkbox"/> Eyewash/Shower Station <input type="checkbox"/> Emergency Shower <input type="checkbox"/> Flush Rim Sink <input type="checkbox"/> Floor Drain <input type="checkbox"/> Water Bottle Refill Station Other: <input type="text"/>	<b>MED / NON-MED GASES</b> (Quantity) Oxygen: <input type="text" value="4"/> Medical Air: <input type="text" value="2"/> Medical Vacuum: <input type="text" value="4"/> Nitrous Oxide: <input type="text"/> CO2: <input type="text"/> AGSS: <input type="text"/> Nitrogen: <input type="text"/> Laboratory Air: <input type="text"/> Laboratory Vacuum: <input type="text"/> Utility Compressed Air: <input type="text"/> Gas Remarks: Provide (2) O2, (1) Medical Air and (2) Medical Vacuum on each side of bed.
--	--	---

# Appendix 1B Minimum Room Requirements

Room Name:

Program Number(s):

1. C1.08	7.	13.	19.	25.	31.	37.	43.
2.	8.	14.	20.	26.	32.	38.	44.
3.	9.	15.	21.	27.	33.	39.	45.
4.	10.	16.	22.	28.	34.	40.	46.
5.	11.	17.	23.	29.	35.	41.	47.
6.	12.	18.	24.	30.	36.	42.	48.

## ARCHITECTURAL REQUIREMENTS

<b>WALL AND CEILING</b> Wall Material: <input type="text" value="ARGB 1.2m AFF, GB above"/> Finish: <input type="text" value="PT"/> Ceiling Material: <input type="text" value="ACT"/> Finish: <input type="text" value="PF"/>	<b>WALL PROTECTION</b> Type: <input type="text" value="FRL"/> <input checked="" type="checkbox"/> Corner Guards <input type="checkbox"/> Hand Rails <input type="checkbox"/> Bed Bumper / Locator Height: <input type="text" value="1350 mm"/> <input type="checkbox"/> Crash Rails <input checked="" type="checkbox"/> Chair Rail	<b>GLAZING</b> <input checked="" type="checkbox"/> Interior Glazing	<b>FLOORING TYPES</b> Material: <input type="text" value="VSF"/> Base: <input type="text" value="FCB"/>	<b>ROOM ACCESSORIES</b> <input type="checkbox"/> Coat Hooks <input type="checkbox"/> Ceiling Lift <input type="checkbox"/> Magnetic Whiteboard <input type="checkbox"/> Mirror <input type="checkbox"/> Infant Change Table <input type="checkbox"/> Privacy Curtain
--	--	--	--	--

- LEGEND:**
- WALL AND CEILING LEGEND:**
- AC Architectural Ceiling
  - ACT Acoustic Ceiling Tile
  - ACT-C Cleanroom
  - ARGB Abuse-Resistant Gypsum Board
  - GB Gypsum Board
  - IRGB Impact-Resistant Gypsum Board
  - KLCT Kitchen Lay-in Ceiling Tile
  - MMRGB Moisture and Mould-Resistant Gypsum Board
  - SACT Security Acoustic Ceiling Tile
- WALL FINISHES LEGEND:**
- EWC Epoxy Wall Coating
  - HPC High Performance Coating
  - PT Paint
- CEILING FINISHES LEGEND:**
- ECC Epoxy Ceiling Coating
  - HPC High Performance Coating
  - PF Prefinished
  - PT Paint
- WALL PROTECTION LEGEND:**
- ESRP Extruded Semi-Rigid PVCu Panel
  - FRL Fibre Reinforced Laminate
  - FRP Fibreglass Reinforced Plastic
  - PVV Protective Vinyl Wallcovering
  - RHIS Rigid High Impact Sheet
  - WSSP Wetwall Solid Surface Panel
  - WVV Wetroom Vinyl Wallcovering
- FLOOR FINISHES LEGEND:**
- CFS Concrete Floor Sealer
  - EFC Epoxy Floor Coating
  - PFC Polyurethane Floor Coating
  - RAF Rubber Athletic Flooring
  - RSF Rubber Sheet Flooring
  - SCF Seamless Cushioned Flooring
  - SDRF Static-Dissipative Rubber Sheet Flooring
  - SDVF Static-Dissipative Vinyl Sheet Flooring
  - VSF Vinyl Sheet Flooring
  - WSVF Wetroom Safety Vinyl Sheet Flooring
- FLOOR BASE LEGEND:**
- FCB Flash Cove Base
  - RB Rubber Base
  - SCF Seamless Cushioned Flooring

**DOORS**

Types:

Type	Qty	Size (mm)	Material	Finish	Side Lt.	Blinds	Protect.	Privacy Film	Function	Card Reader	Mag Lock	Auto Opener	Hold Open	Hinges	Accessory 1	Accessory 2	Accessory 3	Closer
C	2	915 x 2135	Solid Core	FRL	<input type="checkbox"/>	<input type="checkbox"/>	1 Low	<input type="checkbox"/>	Storeroom	<input checked="" type="checkbox"/>	<input type="checkbox"/>	<input type="checkbox"/>	<input type="checkbox"/>	Butt Hinge				Surface

**DOOR REMARKS:**

Security Grille  
 Anti-barricade strategy

**MILLWORK AND SPECIALTY CASEWORK**

Storage Requirements:

**UPPER UNITS:** U1  U2  U3  U4  U5  U6  U7  U8

**LOWER UNITS:** L1  L2  L3  L4  L5  L6  L7  L8  L9  L10  L11  L12

**RECEPTION/TRANSACTION COUNTER / CARE TEAM STATION DESK:** TC1  TC2

**UTILITY SINK AND COUNTER UNIT:** UC1

**SHELF:** S1

**FULL-HEIGHT CABINETS:** C1  C2  C3  C4  C5

**Legend:**

Category	Min. Length (mm)	Motorized Adjustable Height	Standing Height	Specialty Casework
3	3600	<input checked="" type="checkbox"/>	<input type="checkbox"/>	<input type="checkbox"/>

**FINISHES**

Full-height Cabinet:

Upper Millwork:

Countertop:

Lower Millwork:

Shelf:

**REMARKS:**

Provide clear, physical barrier between Staff and Patients in accordance with Fraser Health Standard: Emergency Department - Patient Check-in Station.

## MECHANICAL REQUIREMENTS

<b>PLUMBING</b> (Quantity) Hand Hygiene Sink: <input type="text"/> Lavatory: <input type="text"/> Kitchen Sink: <input type="text"/> Seamless Kitchen Sink: <input type="text"/> Utility / Process Sink: <input type="text"/> Scrub Sink: <input type="text"/> Floor Sink: <input type="text"/> Plumbing Remarks: <input type="text"/>	Other Fixtures: <input type="checkbox"/> Shower <input type="checkbox"/> Tub <input type="checkbox"/> Ice Maker <input type="checkbox"/> Water Closet <input type="checkbox"/> Instantaneous Hot Water <input type="checkbox"/> Ewwash Station <input type="checkbox"/> Ewwash/Shower Station <input type="checkbox"/> Emergency Shower <input type="checkbox"/> Flush Rim Sink <input type="checkbox"/> Floor Drain <input type="checkbox"/> Water Bottle Refill Station Other: <input type="text"/>	<b>MED / NON-MED GASES</b> (Quantity) Oxygen: <input type="text"/> Medical Air: <input type="text"/> Medical Vacuum: <input type="text"/> Nitrous Oxide: <input type="text"/> CO2: <input type="text"/> AGSS: <input type="text"/> Nitrogen: <input type="text"/> Laboratory Air: <input type="text"/> Laboratory Vacuum: <input type="text"/> Utility Compressed Air: <input type="text"/> Gas Remarks: <input type="text"/>
---	---	---



**Appendix 1B Minimum Room Requirements**

Room Name:

Program Number(s):

1.	C3.05	7.		13.		19.		25.		31.		37.		43.
2.		8.		14.		20.		26.		32.		38.		44.
3.		9.		15.		21.		27.		33.		39.		45.
4.		10.		16.		22.		28.		34.		40.		46.
5.		11.		17.		23.		29.		35.		41.		47.
6.		12.		18.		24.		30.		36.		42.		48.

**ARCHITECTURAL REQUIREMENTS**

<b>WALL AND CEILING</b> Wall Material: <input type="text" value="ARGB 1.2m AFF, GB above"/> Finish: <input type="text" value="PT"/> Ceiling Material: <input type="text" value="ACT"/> Finish: <input type="text" value="PF"/>		<b>WALL PROTECTION</b> Type: <input type="text" value="FRL"/> Height: <input type="text" value="1350 mm"/> <input checked="" type="checkbox"/> Corner Guards <input type="checkbox"/> Hand Rails <input type="checkbox"/> Bed Bumper / Locator <input type="checkbox"/> Crash Rails <input checked="" type="checkbox"/> Chair Rail			<b>GLAZING</b> <input type="checkbox"/> Interior Glazing		<b>FLOORING TYPES</b> Material: <input type="text" value="VSF"/> Base: <input type="text" value="FCB"/>		<b>ROOM ACCESSORIES</b> <input checked="" type="checkbox"/> Coat Hooks <input type="checkbox"/> Ceiling Lift <input type="checkbox"/> Magnetic Whiteboard <input type="checkbox"/> Mirror <input type="checkbox"/> Infant Change Table <input type="checkbox"/> Privacy Curtain		
--	--	---	--	--	---	--	--	--	---	--	--

- LEGEND:**
- WALL AND CEILING LEGEND:**
- AC Architectural Ceiling
  - ACT Acoustic Ceiling Tile
  - ACT-C Cleanroom
  - ARGB Abuse-Resistant Gypsum Board
  - GB Gypsum Board
  - IRGB Impact-Resistant Gypsum Board
  - KLCT Kitchen Lay-in Ceiling Tile
  - MMRGB Moisture and Mould-Resistant Gypsum Board
  - SACT Security Acoustic Ceiling Tile
- WALL FINISHES LEGEND:**
- EWC Epoxy Wall Coating
  - HPC High Performance Coating
  - PT Paint
- CEILING FINISHES LEGEND:**
- ECC Epoxy Ceiling Coating
  - HPC High Performance Coating
  - PF Prefinished
  - PT Paint
- WALL PROTECTION LEGEND:**
- ESRP Extruded Semi-Rigid PVCu Panel
  - FRL Fibre Reinforced Laminate
  - FRP Fibreglass Reinforced Plastic
  - PVV Protective Vinyl Wallcovering
  - RHIS Rigid High Impact Sheet
  - WSSP Wetwall Solid Surface Panel
  - WVV Wetroom Vinyl Wallcovering
- FLOOR FINISHES LEGEND:**
- CFS Concrete Floor Sealer
  - EFC Epoxy Floor Coating
  - PFC Polyurethane Floor Coating
  - RAF Rubber Athletic Flooring
  - RSF Rubber Sheet Flooring
  - SCF Seamless Cushioned Flooring
  - SDRF Static-Dissipative Rubber Sheet Flooring
  - SDVF Static-Dissipative Vinyl Sheet Flooring
  - VSF Vinyl Sheet Flooring
  - WSVF Wetroom Safety Vinyl Sheet Flooring
- FLOOR BASE LEGEND:**
- FCB Flash Cove Base
  - RB Rubber Base
  - SCF Seamless Cushioned Flooring

**DOORS**

Types:

Type	Qty	Size (mm)	Material	Finish	Side Lt.	Blinds	Protect.	Privacy Film	Function	Card Reader	Mag Lock	Auto Opener	Hold Open	Hinges	Accessory 1	Accessory 2	Accessory 3	Closer
C	1	1065 x 2135	Solid Core	FRL	<input type="checkbox"/>	<input checked="" type="checkbox"/>	1 Low	<input type="checkbox"/>	Classroom	<input type="checkbox"/>	<input type="checkbox"/>	<input type="checkbox"/>	<input type="checkbox"/>	Butt Hinge				Surface

Door Remarks:  Security Grille  Anti-barricade strategy



**MECHANICAL REQUIREMENTS**

<b>PLUMBING</b> (Quantity) Hand Hygiene Sink: <input type="text"/> Lavatory: <input type="text"/> Kitchen Sink: <input type="text"/> Seamless Kitchen Sink: <input type="text"/> Utility / Process Sink: <input type="text"/> Scrub Sink: <input type="text"/> Floor Sink: <input type="text"/>							Other Fixtures: <input type="checkbox"/> Shower <input type="checkbox"/> Tub <input type="checkbox"/> Ice Maker <input type="checkbox"/> Water Closet <input type="checkbox"/> Instantaneous Hot Water			<input type="checkbox"/> Eyewash Station <input type="checkbox"/> Eyewash/Shower Station <input type="checkbox"/> Emergency Shower <input type="checkbox"/> Flush Rim Sink <input type="checkbox"/> Floor Drain <input type="checkbox"/> Water Bottle Refill Station			<b>MED / NON-MED GASES</b> (Quantity) Oxygen: <input type="text"/> Medical Air: <input type="text"/> Medical Vacuum: <input type="text"/> Nitrous Oxide: <input type="text"/> CO2: <input type="text"/> AGSS: <input type="text"/> Nitrogen: <input type="text"/> Laboratory Air: <input type="text"/> Laboratory Vacuum: <input type="text"/> Utility Compressed Air: <input type="text"/>				
Plumbing Remarks: <input type="text"/>							Other: <input type="text"/>			Gas Remarks: <input type="text"/>							



# Appendix 1B Minimum Room Requirements

Room Name:

Program Number(s):

1. C2.15	7.	13.	19.	25.	31.	37.	43.
2.	8.	14.	20.	26.	32.	38.	44.
3.	9.	15.	21.	27.	33.	39.	45.
4.	10.	16.	22.	28.	34.	40.	46.
5.	11.	17.	23.	29.	35.	41.	47.
6.	12.	18.	24.	30.	36.	42.	48.

## ARCHITECTURAL REQUIREMENTS

<b>WALL AND CEILING</b> Wall Material: <input type="text" value="IRGB"/> Finish: <input type="text" value="PT"/> Ceiling Material: <input type="text" value="MMRGB"/> Finish: <input type="text" value="PT"/>	<b>WALL PROTECTION</b> Type: <input type="text"/> Height: <input type="text"/> <input checked="" type="checkbox"/> Corner Guards <input type="checkbox"/> Hand Rails <input type="checkbox"/> Bed Bumper / Locator <input type="checkbox"/> Crash Rails <input checked="" type="checkbox"/> Chair Rail	<b>GLAZING</b> <input checked="" type="checkbox"/> Interior Glazing	<b>FLOORING TYPES</b> Material: <input type="text" value="SCF"/> Base: <input type="text" value="SCF"/>	<b>ROOM ACCESSORIES</b> <input type="checkbox"/> Coat Hooks <input type="checkbox"/> Ceiling Lift <input type="checkbox"/> Magnetic Whiteboard <input type="checkbox"/> Mirror <input type="checkbox"/> Infant Change Table <input type="checkbox"/> Privacy Curtain
---	---	--	--	--

- LEGEND:**
- WALL AND CEILING LEGEND:**
- AC Architectural Ceiling
  - ACT Acoustic Ceiling Tile
  - ACT-C Cleanroom
  - ARGB Abuse-Resistant Gypsum Board
  - GB Gypsum Board
  - IRGB Impact-Resistant Gypsum Board
  - KLCT Kitchen Lay-in Ceiling Tile
  - MMRGB Moisture and Mould-Resistant Gypsum Board
  - SACT Security Acoustic Ceiling Tile
- WALL FINISHES LEGEND:**
- EWC Epoxy Wall Coating
  - HPC High Performance Coating
  - PT Paint
- CEILING FINISHES LEGEND:**
- ECC Epoxy Ceiling Coating
  - HPC High Performance Coating
  - PF Prefinished
  - PT Paint
- WALL PROTECTION LEGEND:**
- ESRP Extruded Semi-Rigid PVCu Panel
  - FRL Fibre Reinforced Laminate
  - FRP Fibreglass Reinforced Plastic
  - PVV Protective Vinyl Wallcovering
  - RHIS Rigid High Impact Sheet
  - WSSP Wetwall Solid Surface Panel
  - WVV Wetroom Vinyl Wallcovering
- FLOOR FINISHES LEGEND:**
- CFS Concrete Floor Sealer
  - EFC Epoxy Floor Coating
  - PFC Polyurethane Floor Coating
  - RAF Rubber Athletic Flooring
  - RSF Rubber Sheet Flooring
  - SCF Seamless Cushioned Flooring
  - SDRF Static-Dissipative Rubber Sheet Flooring
  - SDVF Static-Dissipative Vinyl Sheet Flooring
  - VSF Vinyl Sheet Flooring
  - WSVF Wetroom Safety Vinyl Sheet Flooring
- FLOOR BASE LEGEND:**
- FCB Flash Cove Base
  - RB Rubber Base
  - SCF Seamless Cushioned Flooring

**DOORS**

Types:

Type	Qty	Size (mm)	Material	Finish	Side Lt.	Blinds	Protect.	Privacy Film	Function	Card Reader	Mag Lock	Auto Opener	Hold Open	Hinges	Accessory 1	Accessory 2	Accessory 3	Closer
C	1	1220 x 2135	Hollow Metal	Paint	<input type="checkbox"/>	<input type="checkbox"/>		<input type="checkbox"/>	Classroom	<input type="checkbox"/>	<input checked="" type="checkbox"/>	<input type="checkbox"/>	<input type="checkbox"/>	Continuous	Safety Stop			

**Door Remarks:**  
 Refer to Schedule 1 for Secure Room door hardware requirements.  
 Door to outswing 180 degrees with lock and key hardware.  
 Door to have half window  
 Security Grille  
 Anti-barricade strategy

**MILLWORK AND SPECIALTY CASEWORK**

**UPPER UNITS** (U1-U8) **LOWER UNITS** (L1-L12) **RECEPTION/TRANSACTION COUNTER / CARE TEAM STATION DESK** (TC1-TC2) **UTILITY SINK AND COUNTER UNIT** (UC1)

**Storage Requirements:**

**FINISHES**

Full-height Cabinet:   
 Upper Millwork:   
 Countertop:   
 Lower Millwork:   
 Shelf:

**Remarks:**  
 Refer to Schedule 1 for additional Secure Room requirements

**Legend:**  
 Category 0 - None  
 Category 1 - Low (1% - 4%)  
 Category 2 - Med (5% - 9%)  
 Category 3 - High (10% or Greater)

Category	Min. Length (mm)	Motorized Adjustable Height	Standing Height	Specialty Casework
		<input type="checkbox"/>	<input type="checkbox"/>	<input type="checkbox"/>

## MECHANICAL REQUIREMENTS

**PLUMBING** (Quantity)

Hygiene Sink:	Lavatory:	Kitchen Sink:	Seamless Kitchen Sink:	Utility / Process Sink:	Scrub Sink:	Floor Sink:
	1					

Plumbing Remarks:

**Other Fixtures:**

- Shower
- Tub
- Ice Maker
- Water Closet
- Instantaneous Hot Water
- Eyewash Station
- Eyewash/Shower Station
- Emergency Shower
- Flush Rim Sink
- Floor Drain
- Water Bottle Refill Station

Other:

**MED / NON-MED GASES** (Quantity)

Oxygen:	Medical Air:	Medical Vacuum:	Nitrous Oxide:	CO2:	AGSS:	Nitrogen:	Laboratory Air:	Laboratory Vacuum:	Utility Compressed Air:

Gas Remarks:

# Appendix 1B Minimum Room Requirements

Room Name:

Program Number(s):	1. C1.03	7.	13.	19.	25.	31.	37.	43.
	2.	8.	14.	20.	26.	32.	38.	44.
	3.	9.	15.	21.	27.	33.	39.	45.
	4.	10.	16.	22.	28.	34.	40.	46.
	5.	11.	17.	23.	29.	35.	41.	47.
	6.	12.	18.	24.	30.	36.	42.	48.

## ARCHITECTURAL REQUIREMENTS

<b>WALL AND CEILING</b> Wall Material: <input type="text" value="GB"/> Finish: <input type="text" value="PT"/> Ceiling Material: <input type="text" value="ACT"/> Finish: <input type="text" value="PF"/>	<b>WALL PROTECTION</b> Type: <input type="text" value="PVW"/> <input type="checkbox"/> Corner Guards <input type="checkbox"/> Hand Rails <input type="checkbox"/> Bed Bumper / Locator Height: <input type="text" value="1350 mm"/> <input type="checkbox"/> Crash Rails <input checked="" type="checkbox"/> Chair Rail	<b>GLAZING</b> <input checked="" type="checkbox"/> Interior Glazing	<b>FLOORING TYPES</b> Material: <input type="text" value="VSF"/> Base: <input type="text" value="FCB"/>	<b>ROOM ACCESSORIES</b> <input type="checkbox"/> Coat Hooks <input type="checkbox"/> Ceiling Lift <input checked="" type="checkbox"/> Magnetic Whiteboard <input type="checkbox"/> Mirror <input type="checkbox"/> Infant Change Table <input type="checkbox"/> Privacy Curtain
---	---	--	--	---

- LEGEND:**
- WALL AND CEILING LEGEND:**
- AC Architectural Ceiling
  - ACT Acoustic Ceiling Tile
  - ACT-C Cleanroom
  - ARGB Abuse-Resistant Gypsum Board
  - GB Gypsum Board
  - IRGB Impact-Resistant Gypsum Board
  - KLCT Kitchen Lay-in Ceiling Tile
  - MMRGB Moisture and Mould-Resistant Gypsum Board
  - SACT Security Acoustic Ceiling Tile
- WALL FINISHES LEGEND:**
- EWC Epoxy Wall Coating
  - HPC High Performance Coating
  - PT Paint
- CEILING FINISHES LEGEND:**
- ECC Epoxy Ceiling Coating
  - HPC High Performance Coating
  - PF Prefinished
  - PT Paint
- WALL PROTECTION LEGEND:**
- ESRP Extruded Semi-Rigid PVCu Panel
  - FRL Fibre Reinforced Laminate
  - FRP Fibreglass Reinforced Plastic
  - PVW Protective Vinyl Wallcovering
  - RHIS Rigid High Impact Sheet
  - WSSP Wetwall Solid Surface Panel
  - WVV Wetroom Vinyl Wallcovering
- FLOOR FINISHES LEGEND:**
- CFS Concrete Floor Sealer
  - EFC Epoxy Floor Coating
  - PFC Polyurethane Floor Coating
  - RAF Rubber Athletic Flooring
  - RSF Rubber Sheet Flooring
  - SCF Seamless Cushioned Flooring
  - SDRF Static-Dissipative Rubber Sheet Flooring
  - SDVF Static-Dissipative Vinyl Sheet Flooring
  - VSF Vinyl Sheet Flooring
  - WSVF Wetroom Safety Vinyl Sheet Flooring
- FLOOR BASE LEGEND:**
- FCB Flash Cove Base
  - RB Rubber Base
  - SCF Seamless Cushioned Flooring

**DOORS**

Types:

Type	Qty	Size (mm)	Material	Finish	Side Lt.	Blinds	Protect.	Privacy Film	Function	Card Reader	Mag Lock	Auto Opener	Hold Open	Hinges	Accessory 1	Accessory 2	Accessory 3	Closer
B	1	915 x 2135	Solid Core	FRL	<input type="checkbox"/>	<input type="checkbox"/>	1 Low	<input type="checkbox"/>	Storeroom	<input checked="" type="checkbox"/>	<input type="checkbox"/>	<input type="checkbox"/>	<input type="checkbox"/>	Butt Hinge				Surface

**DOOR REMARKS:**

Security Grille  
 Anti-barricade strategy

**MILLWORK AND SPECIALTY CASEWORK**

Storage Requirements:

**UPPER UNITS:** U1, U2, U3, U4, U5, U6, U7, U8

**LOWER UNITS:** L1, L2, L3, L4, L5, L6, L7, L8, L9, L10, L11, L12

**RECEPTION/TRANSACTION COUNTER / CARE TEAM STATION DESK:** TC1, TC2

**UTILITY SINK AND COUNTER UNIT:** UC1

**SHELF:** S1

**FULL-HEIGHT CABINETS:** C1, C2, C3, C4, C5

**Legend:**

Category	Min. Length (mm)	Motorized Adjustable Height	Standing Height	Specialty Casework
Category 0 - None				
Category 1 - Low (1% - 4%)				
Category 2 - Med (5% - 9%)				
Category 3 - High (10% or Greater)	3	1500	<input type="checkbox"/>	<input type="checkbox"/>

**FINISHES**

Full-height Cabinet:

Upper Millwork:

Countertop:

Lower Millwork:

Shelf:

**REMARKS:**

## MECHANICAL REQUIREMENTS

**PLUMBING**

Hand Hygiene Sink:	Lavatory:	Kitchen Sink:	Seamless Kitchen Sink:	Utility / Process Sink:	Scrub Sink:	Floor Sink:
<input type="text"/>	<input type="text"/>	<input type="text"/>	<input type="text"/>	<input type="text"/>	<input type="text"/>	<input type="text"/>

Plumbing Remarks:

**Other Fixtures:**

- Shower
- Tub
- Ice Maker
- Water Closet
- Instantaneous Hot Water
- Eyewash Station
- Eyewash/Shower Station
- Emergency Shower
- Flush Rim Sink
- Floor Drain
- Water Bottle Refill Station
- Other:

**MED / NON-MED GASES**

Oxygen:	Medical Air:	Medical Vacuum:	Nitrous Oxide:	CO2:	AGSS:	Nitrogen:	Laboratory Air:	Laboratory Vacuum:	Utility Compressed Air:
<input type="text"/>	<input type="text"/>	<input type="text"/>	<input type="text"/>	<input type="text"/>	<input type="text"/>	<input type="text"/>	<input type="text"/>	<input type="text"/>	<input type="text"/>

Gas Remarks:

**Appendix 1B Minimum Room Requirements**

Room Name:

Program Number(s):

1. C2.06	7.	13.	19.	25.	31.	37.	43.
2.	8.	14.	20.	26.	32.	38.	44.
3.	9.	15.	21.	27.	33.	39.	45.
4.	10.	16.	22.	28.	34.	40.	46.
5.	11.	17.	23.	29.	35.	41.	47.
6.	12.	18.	24.	30.	36.	42.	48.

**ARCHITECTURAL REQUIREMENTS**

<b>WALL AND CEILING</b> Wall Material: <input type="text" value="ARGB 1.2m AFF, GB above"/> Finish: <input type="text" value="PT"/> Ceiling Material: <input type="text" value="GB"/> Finish: <input type="text" value="ECC"/>	<b>WALL PROTECTION</b> Type: <input type="text" value="WVW"/> <input checked="" type="checkbox"/> Corner Guards <input type="checkbox"/> Hand Rails <input type="checkbox"/> Bed Bumper / Locator Height: <input type="text" value="2185 mm"/> <input checked="" type="checkbox"/> Crash Rails <input type="checkbox"/> Chair Rail	<b>GLAZING</b> <input type="checkbox"/> Interior Glazing	<b>FLOORING TYPES</b> Material: <input type="text" value="WSVF"/> Base: <input type="text" value="FCB"/>	<b>ROOM ACCESSORIES</b> <input type="checkbox"/> Coat Hooks <input type="checkbox"/> Ceiling Lift <input type="checkbox"/> Magnetic Whiteboard <input type="checkbox"/> Mirror <input type="checkbox"/> Infant Change Table <input type="checkbox"/> Privacy Curtain
--	--	---	---	--

- LEGEND:**
- WALL AND CEILING LEGEND:**
- AC Architectural Ceiling
  - ACT Acoustic Ceiling Tile
  - ACT-C Cleanroom
  - ARGB Abuse-Resistant Gypsum Board
  - GB Gypsum Board
  - IRGB Impact-Resistant Gypsum Board
  - KLCT Kitchen Lay-in Ceiling Tile
  - MMRGB Moisture and Mould-Resistant Gypsum Board
  - SACT Security Acoustic Ceiling Tile
- WALL FINISHES LEGEND:**
- EWC Epoxy Wall Coating
  - HPC High Performance Coating
  - PT Paint
- CEILING FINISHES LEGEND:**
- ECC Epoxy Ceiling Coating
  - HPC High Performance Coating
  - PF Prefinished
  - PT Paint
- WALL PROTECTION LEGEND:**
- ESRP Extruded Semi-Rigid PVCu Panel
  - FRL Fibre Reinforced Laminate
  - FRP Fibreglass Reinforced Plastic
  - PVW Protective Vinyl Wallcovering
  - RHIS Rigid High Impact Sheet
  - WSSP Wetwall Solid Surface Panel
  - WVW Wetroom Vinyl Wallcovering
- FLOOR FINISHES LEGEND:**
- CFS Concrete Floor Sealer
  - EFC Epoxy Floor Coating
  - PFC Polyurethane Floor Coating
  - RAF Rubber Athletic Flooring
  - RSF Rubber Sheet Flooring
  - SCF Seamless Cushioned Flooring
  - SDRF Static-Dissipative Rubber Sheet Flooring
  - SDVF Static-Dissipative Vinyl Sheet Flooring
  - VSF Vinyl Sheet Flooring
  - WSVF Wetroom Safety Vinyl Sheet Flooring
- FLOOR BASE LEGEND:**
- FCB Flash Cove Base
  - RB Rubber Base
  - SCF Seamless Cushioned Flooring

**DOORS**

Types:

Type	Qty	Size (mm)	Material	Finish	Side Lt.	Blinds	Protect.	Privacy Film	Function	Card Reader	Mag Lock	Auto Opener	Hold Open	Hinges	Accessory 1	Accessory 2	Accessory 3	Closer
C	1	1220 x 2135	Solid Core	FRL	<input type="checkbox"/>	<input type="checkbox"/>	2 High	<input type="checkbox"/>	Storeroom	<input checked="" type="checkbox"/>	<input type="checkbox"/>	<input checked="" type="checkbox"/>	<input type="checkbox"/>	Butt Hinge	Elec. Strike			Surface

Door Remarks:  Security Grille  Anti-barricade strategy

Provide PIN/Prox Card reader for door

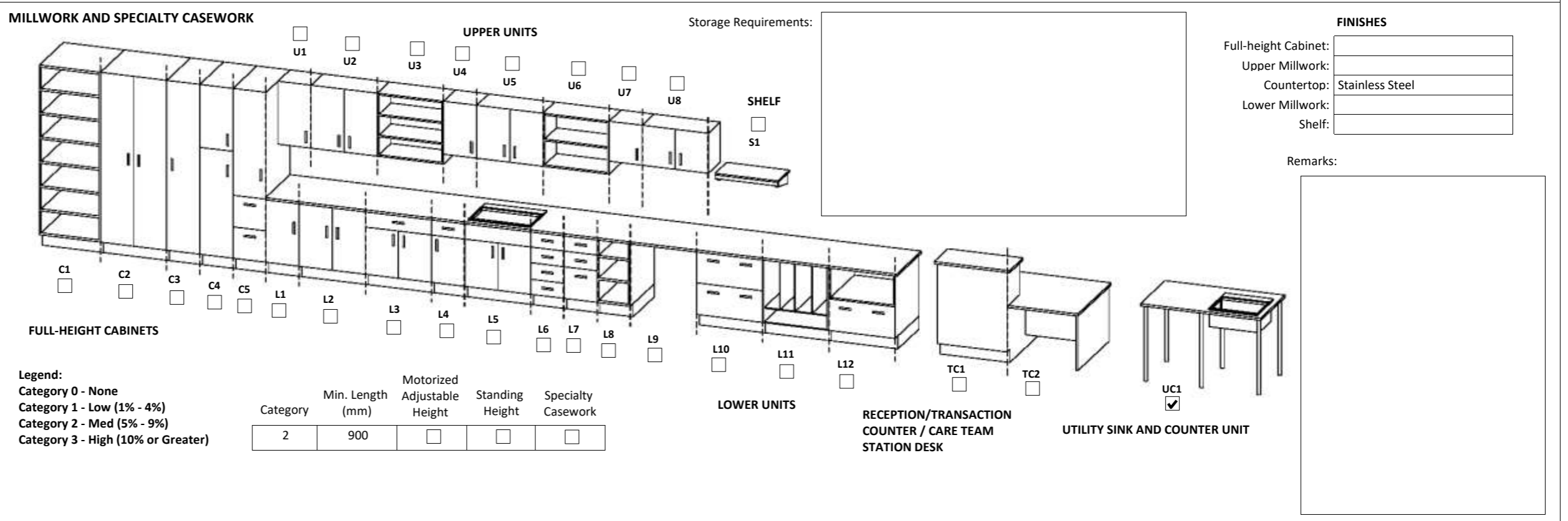

**MECHANICAL REQUIREMENTS**

<b>PLUMBING</b> (Quantity) Hand Hygiene Sink: <input type="text" value="1"/> Lavatory: <input type="text"/> Kitchen Sink: <input type="text"/> Seamless Kitchen Sink: <input type="text"/> Utility / Process Sink: <input type="text" value="1"/> Scrub Sink: <input type="text"/> Floor Sink: <input type="text"/> Plumbing Remarks: <input type="text" value="Provide utility sink c/w backflow preventer."/>	Other Fixtures: <input type="checkbox"/> Shower <input type="checkbox"/> Tub <input type="checkbox"/> Ice Maker <input type="checkbox"/> Water Closet <input type="checkbox"/> Instantaneous Hot Water <input type="checkbox"/> Eyewash Station <input type="checkbox"/> Eyewash/Shower Station <input type="checkbox"/> Emergency Shower <input checked="" type="checkbox"/> Flush Rim Sink <input checked="" type="checkbox"/> Floor Drain <input type="checkbox"/> Water Bottle Refill Station Other: <input type="text"/>	<b>MED / NON-MED GASES</b> (Quantity) Oxygen: <input type="text"/> Medical Air: <input type="text"/> Medical Vacuum: <input type="text"/> Nitrous Oxide: <input type="text"/> CO2: <input type="text"/> AGSS: <input type="text"/> Nitrogen: <input type="text"/> Laboratory Air: <input type="text"/> Laboratory Vacuum: <input type="text"/> Utility Compressed Air: <input type="text"/> Gas Remarks: <input type="text"/>
--	--	---



**Appendix 1B Minimum Room Requirements**

Room Name:

Program Number(s):	1. C2.11	7.	13.	19.	25.	31.	37.	43.
	2.	8.	14.	20.	26.	32.	38.	44.
	3.	9.	15.	21.	27.	33.	39.	45.
	4.	10.	16.	22.	28.	34.	40.	46.
	5.	11.	17.	23.	29.	35.	41.	47.
	6.	12.	18.	24.	30.	36.	42.	48.

**ARCHITECTURAL REQUIREMENTS**

<b>WALL AND CEILING</b> Wall Material: <input type="text" value="ARGB 1.2m AFF, GB above"/> Finish: <input type="text" value="EWC"/> Ceiling Material: <input type="text" value="ACT"/> Finish: <input type="text" value="PF"/>	<b>WALL PROTECTION</b> Type: <input type="text" value="ESRP"/> <input checked="" type="checkbox"/> Corner Guards <input type="checkbox"/> Hand Rails <input type="checkbox"/> Bed Bumper / Locator Height: <input type="text" value="1600 mm"/> <input type="checkbox"/> Crash Rails <input type="checkbox"/> Chair Rail	<b>GLAZING</b> <input type="checkbox"/> Interior Glazing	<b>FLOORING TYPES</b> Material: <input type="text" value="VSF"/> Base: <input type="text" value="FCB"/>	<b>ROOM ACCESSORIES</b> <input type="checkbox"/> Coat Hooks <input type="checkbox"/> Ceiling Lift <input checked="" type="checkbox"/> Magnetic Whiteboard <input type="checkbox"/> Mirror <input type="checkbox"/> Infant Change Table <input type="checkbox"/> Privacy Curtain
---	--	---	--	---

- LEGEND:**
- WALL AND CEILING LEGEND:**
- AC Architectural Ceiling
  - ACT Acoustic Ceiling Tile
  - ACT-C Cleanroom
  - ARGB Abuse-Resistant Gypsum Board
  - GB Gypsum Board
  - IRGB Impact-Resistant Gypsum Board
  - KLCT Kitchen Lay-in Ceiling Tile
  - MMRGB Moisture and Mould-Resistant Gypsum Board
  - SACT Security Acoustic Ceiling Tile
- WALL FINISHES LEGEND:**
- EWC Epoxy Wall Coating
  - HPC High Performance Coating
  - PT Paint
- CEILING FINISHES LEGEND:**
- ECC Epoxy Ceiling Coating
  - HPC High Performance Coating
  - PF Prefinished
  - PT Paint
- WALL PROTECTION LEGEND:**
- ESRP Extruded Semi-Rigid PVCu Panel
  - FRL Fibre Reinforced Laminate
  - FRP Fibreglass Reinforced Plastic
  - PVV Protective Vinyl Wallcovering
  - RHIS Rigid High Impact Sheet
  - WSSP Wetwall Solid Surface Panel
  - WVV Wetroom Vinyl Wallcovering
- FLOOR FINISHES LEGEND:**
- CFS Concrete Floor Sealer
  - EFC Epoxy Floor Coating
  - PFC Polyurethane Floor Coating
  - RAF Rubber Athletic Flooring
  - RSF Rubber Sheet Flooring
  - SCF Seamless Cushioned Flooring
  - SDRF Static-Dissipative Rubber Sheet Flooring
  - SDVF Static-Dissipative Vinyl Sheet Flooring
  - VSF Vinyl Sheet Flooring
  - WSVF Wetroom Safety Vinyl Sheet Flooring
- FLOOR BASE LEGEND:**
- FCB Flash Cove Base
  - RB Rubber Base
  - SCF Seamless Cushioned Flooring

**DOORS**

Types:

Type	Qty	Size (mm)	Material	Finish	Side Lt.	Blinds	Protect.	Privacy Film	Function	Card Reader	Mag Lock	Auto Opener	Hold Open	Hinges	Accessory 1	Accessory 2	Accessory 3	Closer
C	1	1220 x 2135	Solid Core	FRL	<input type="checkbox"/>	<input type="checkbox"/>	2 High	<input type="checkbox"/>	Storeroom	<input checked="" type="checkbox"/>	<input type="checkbox"/>	<input type="checkbox"/>	<input checked="" type="checkbox"/>	Cont. Swing Clear				Surface

**Door Remarks:**  
Refer to Appendix 1A [Clinical Specifications and Functional Space Requirements], Section 2.3 (C. Emergency) for Storage - Decontamination requirements.

Security Grille  
 Anti-barricade strategy

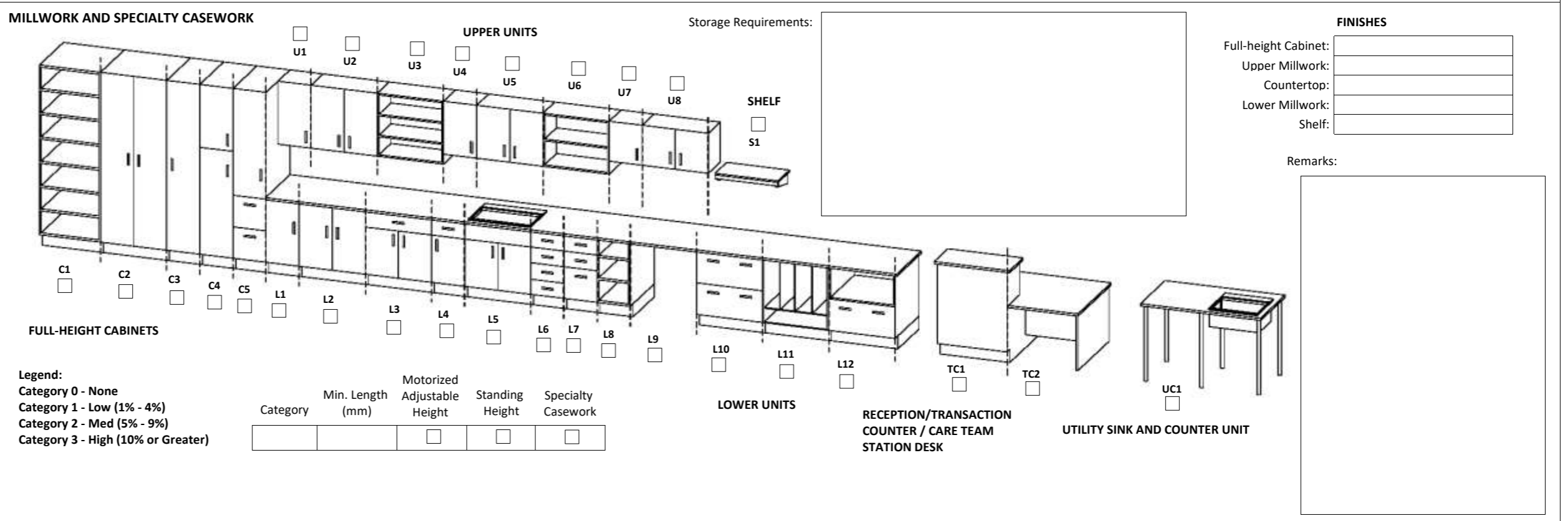

**MECHANICAL REQUIREMENTS**

<p><b>PLUMBING</b> (Quantity)</p> <table border="1" style="width:100%"> <tr> <td>Hand Hygiene Sink:</td> <td>Lavatory:</td> <td>Kitchen Sink:</td> <td>Seamless Kitchen Sink:</td> <td>Utility / Process Sink:</td> <td>Scrub Sink:</td> <td>Floor Sink:</td> </tr> <tr> <td><input type="text"/></td> <td><input type="text"/></td> <td><input type="text"/></td> <td><input type="text"/></td> <td><input type="text"/></td> <td><input type="text"/></td> <td><input type="text"/></td> </tr> </table> <p>Plumbing Remarks: <input style="width:100%" type="text"/></p>	Hand Hygiene Sink:	Lavatory:	Kitchen Sink:	Seamless Kitchen Sink:	Utility / Process Sink:	Scrub Sink:	Floor Sink:	<input type="text"/>	<input type="text"/>	<input type="text"/>	<input type="text"/>	<input type="text"/>	<input type="text"/>	<input type="text"/>	<p><b>Other Fixtures:</b></p> <table border="1" style="width:100%"> <tr> <td><input type="checkbox"/> Shower</td> <td><input type="checkbox"/> Eyewash Station</td> </tr> <tr> <td><input type="checkbox"/> Tub</td> <td><input type="checkbox"/> Eyewash/Shower Station</td> </tr> <tr> <td><input type="checkbox"/> Ice Maker</td> <td><input type="checkbox"/> Emergency Shower</td> </tr> <tr> <td><input type="checkbox"/> Water Closet</td> <td><input type="checkbox"/> Flush Rim Sink</td> </tr> <tr> <td><input type="checkbox"/> Instantaneous Hot Water</td> <td><input type="checkbox"/> Floor Drain</td> </tr> <tr> <td></td> <td><input type="checkbox"/> Water Bottle Refill Station</td> </tr> <tr> <td>Other:</td> <td><input type="text"/></td> </tr> </table>	<input type="checkbox"/> Shower	<input type="checkbox"/> Eyewash Station	<input type="checkbox"/> Tub	<input type="checkbox"/> Eyewash/Shower Station	<input type="checkbox"/> Ice Maker	<input type="checkbox"/> Emergency Shower	<input type="checkbox"/> Water Closet	<input type="checkbox"/> Flush Rim Sink	<input type="checkbox"/> Instantaneous Hot Water	<input type="checkbox"/> Floor Drain		<input type="checkbox"/> Water Bottle Refill Station	Other:	<input type="text"/>	<p><b>MED / NON-MED GASES</b> (Quantity)</p> <table border="1" style="width:100%"> <tr> <td>Oxygen:</td> <td>Medical Air:</td> <td>Medical Vacuum:</td> <td>Nitrous Oxide:</td> <td>CO2:</td> <td>AGSS:</td> <td>Nitrogen:</td> <td>Laboratory Air:</td> <td>Laboratory Vacuum:</td> <td>Utility Compressed Air:</td> </tr> <tr> <td><input type="text"/></td> <td><input type="text"/></td> <td><input type="text"/></td> <td><input type="text"/></td> <td><input type="text"/></td> <td><input type="text"/></td> <td><input type="text"/></td> <td><input type="text"/></td> <td><input type="text"/></td> <td><input type="text"/></td> </tr> </table> <p>Gas Remarks: <input style="width:100%" type="text"/></p>	Oxygen:	Medical Air:	Medical Vacuum:	Nitrous Oxide:	CO2:	AGSS:	Nitrogen:	Laboratory Air:	Laboratory Vacuum:	Utility Compressed Air:	<input type="text"/>	<input type="text"/>	<input type="text"/>	<input type="text"/>	<input type="text"/>	<input type="text"/>	<input type="text"/>	<input type="text"/>	<input type="text"/>	<input type="text"/>
Hand Hygiene Sink:	Lavatory:	Kitchen Sink:	Seamless Kitchen Sink:	Utility / Process Sink:	Scrub Sink:	Floor Sink:																																												
<input type="text"/>	<input type="text"/>	<input type="text"/>	<input type="text"/>	<input type="text"/>	<input type="text"/>	<input type="text"/>																																												
<input type="checkbox"/> Shower	<input type="checkbox"/> Eyewash Station																																																	
<input type="checkbox"/> Tub	<input type="checkbox"/> Eyewash/Shower Station																																																	
<input type="checkbox"/> Ice Maker	<input type="checkbox"/> Emergency Shower																																																	
<input type="checkbox"/> Water Closet	<input type="checkbox"/> Flush Rim Sink																																																	
<input type="checkbox"/> Instantaneous Hot Water	<input type="checkbox"/> Floor Drain																																																	
	<input type="checkbox"/> Water Bottle Refill Station																																																	
Other:	<input type="text"/>																																																	
Oxygen:	Medical Air:	Medical Vacuum:	Nitrous Oxide:	CO2:	AGSS:	Nitrogen:	Laboratory Air:	Laboratory Vacuum:	Utility Compressed Air:																																									
<input type="text"/>	<input type="text"/>	<input type="text"/>	<input type="text"/>	<input type="text"/>	<input type="text"/>	<input type="text"/>	<input type="text"/>	<input type="text"/>	<input type="text"/>																																									



**Appendix 1B Minimum Room Requirements**

Room Name:

Program Number(s):

1. C3.03	7.	13.	19.	25.	31.	37.	43.
2.	8.	14.	20.	26.	32.	38.	44.
3.	9.	15.	21.	27.	33.	39.	45.
4.	10.	16.	22.	28.	34.	40.	46.
5.	11.	17.	23.	29.	35.	41.	47.
6.	12.	18.	24.	30.	36.	42.	48.

**ARCHITECTURAL REQUIREMENTS**

<b>WALL AND CEILING</b> Wall Material: <input type="text" value="ARGB 1.2m AFF, GB above"/> Finish: <input type="text" value="PT"/> Ceiling Material: <input type="text" value="GB"/> Finish: <input type="text" value="PT"/>		<b>WALL PROTECTION</b> Type: <input type="text" value="RHIS"/> <input checked="" type="checkbox"/> Corner Guards <input type="checkbox"/> Hand Rails <input type="checkbox"/> Bed Bumper / Locator Height: <input type="text" value="2185 mm"/> <input checked="" type="checkbox"/> Crash Rails <input type="checkbox"/> Chair Rail		<b>GLAZING</b> <input checked="" type="checkbox"/> Interior Glazing		<b>FLOORING TYPES</b> Material: <input type="text" value="VSF"/> Base: <input type="text" value="FCB"/>		<b>ROOM ACCESSORIES</b> <input type="checkbox"/> Coat Hooks <input checked="" type="checkbox"/> Ceiling Lift <input checked="" type="checkbox"/> Magnetic Whiteboard <input type="checkbox"/> Mirror <input type="checkbox"/> Infant Change Table <input checked="" type="checkbox"/> Privacy Curtain	
---	--	---	--	--	--	--	--	---	--

- LEGEND:**
- WALL AND CEILING LEGEND:**
- AC Architectural Ceiling
  - ACT Acoustic Ceiling Tile
  - ACT-C Cleanroom
  - ARGB Abuse-Resistant Gypsum Board
  - GB Gypsum Board
  - IRGB Impact-Resistant Gypsum Board
  - KLCT Kitchen Lay-in Ceiling Tile
  - MMRGB Moisture and Mould-Resistant Gypsum Board
  - SACT Security Acoustic Ceiling Tile
- WALL FINISHES LEGEND:**
- EWC Epoxy Wall Coating
  - HPC High Performance Coating
  - PT Paint
- CEILING FINISHES LEGEND:**
- ECC Epoxy Ceiling Coating
  - HPC High Performance Coating
  - PF Prefinished
  - PT Paint
- WALL PROTECTION LEGEND:**
- ESRP Extruded Semi-Rigid PVCu Panel
  - FRL Fibre Reinforced Laminate
  - FRP Fibreglass Reinforced Plastic
  - PVV Protective Vinyl Wallcovering
  - RHIS Rigid High Impact Sheet
  - WSSP Wetwall Solid Surface Panel
  - WVV Wetroom Vinyl Wallcovering
- FLOOR FINISHES LEGEND:**
- CFS Concrete Floor Sealer
  - EFC Epoxy Floor Coating
  - PFC Polyurethane Floor Coating
  - RAF Rubber Athletic Flooring
  - RSF Rubber Sheet Flooring
  - SCF Seamless Cushioned Flooring
  - SDRF Static-Dissipative Rubber Sheet Flooring
  - SDVF Static-Dissipative Vinyl Sheet Flooring
  - VSF Vinyl Sheet Flooring
  - WSVF Wetroom Safety Vinyl Sheet Flooring
- FLOOR BASE LEGEND:**
- FCB Flash Cove Base
  - RB Rubber Base
  - SCF Seamless Cushioned Flooring

**DOORS**

Types:

Type	Qty	Size (mm)	Material	Finish	Side Lt.	Blinds	Protect.	Privacy Film	Function	Card Reader	Mag Lock	Auto Opener	Hold Open	Hinges	Accessory 1	Accessory 2	Accessory 3	Closer

Door Remarks:  Security Grille  Anti-barricade strategy



**MECHANICAL REQUIREMENTS**

<b>PLUMBING</b> (Quantity) Hygiene Sink: <input type="text" value="2"/> Lavatory: <input type="text"/> Kitchen Sink: <input type="text"/> Kitchen Sink: <input type="text"/> Utility / Process Sink: <input type="text"/> Scrub Sink: <input type="text"/> Floor Sink: <input type="text"/>		Other Fixtures: <input type="checkbox"/> Shower <input type="checkbox"/> Eyewash Station <input type="checkbox"/> Tub <input type="checkbox"/> Eyewash/Shower Station <input type="checkbox"/> Ice Maker <input type="checkbox"/> Emergency Shower <input type="checkbox"/> Water Closet <input type="checkbox"/> Flush Rim Sink <input type="checkbox"/> Instantaneous Hot Water <input type="checkbox"/> Floor Drain <input type="checkbox"/> <input type="checkbox"/> Water Bottle Refill Station Other: <input type="text"/>		<b>MED / NON-MED GASES</b> (Quantity) Oxygen: <input type="text" value="10"/> Medical Air: <input type="text" value="8"/> Medical Vacuum: <input type="text" value="10"/> Nitrous Oxide: <input type="text"/> CO2: <input type="text"/> AGSS: <input type="text"/> Nitrogen: <input type="text"/> Laboratory Air: <input type="text"/> Laboratory Vacuum: <input type="text"/> Utility Compressed Air: <input type="text"/>	
Plumbing Remarks: <input type="text" value="Provide one HHS per bay."/>				Gas Remarks: <input type="text" value="Provide (1) set of medical gas on wall per bay (1 set being (1) O2/(1) Medical Air/(1) Medical Vacuum). Provide (2) booms per bay. Each boom with 1 set of ((2) O2, (1) Medical Air, (2) Medical Vacuum)."/>	

**Appendix 1B Minimum Room Requirements**

Room Name:

Program Number(s):

1. C2.01	7.	13.	19.	25.	31.	37.	43.
2.	8.	14.	20.	26.	32.	38.	44.
3.	9.	15.	21.	27.	33.	39.	45.
4.	10.	16.	22.	28.	34.	40.	46.
5.	11.	17.	23.	29.	35.	41.	47.
6.	12.	18.	24.	30.	36.	42.	48.

**ARCHITECTURAL REQUIREMENTS**

<b>WALL AND CEILING</b> Wall Material: <input type="text" value="GB"/> Finish: <input type="text" value="PT"/> Ceiling Material: <input type="text" value="ACT"/> Finish: <input type="text" value="PF"/>	<b>WALL PROTECTION</b> Type: <input type="text" value="ESRP"/> <input checked="" type="checkbox"/> Corner Guards <input type="checkbox"/> Hand Rails <input type="checkbox"/> Bed Bumper / Locator Height: <input type="text" value="2185 mm"/> <input type="checkbox"/> Crash Rails <input type="checkbox"/> Chair Rail	<b>GLAZING</b> <input checked="" type="checkbox"/> Interior Glazing	<b>FLOORING TYPES</b> Material: <input type="text" value="VSF"/> Base: <input type="text" value="FCB"/>	<b>ROOM ACCESSORIES</b> <input type="checkbox"/> Coat Hooks <input type="checkbox"/> Ceiling Lift <input type="checkbox"/> Magnetic Whiteboard <input type="checkbox"/> Mirror <input type="checkbox"/> Infant Change Table <input type="checkbox"/> Privacy Curtain
---	--	--	--	--

- LEGEND:**
- WALL AND CEILING LEGEND:**
- AC Architectural Ceiling
  - ACT Acoustic Ceiling Tile
  - ACT-C Cleanroom
  - ARGB Abuse-Resistant Gypsum Board
  - GB Gypsum Board
  - IRGB Impact-Resistant Gypsum Board
  - KLCT Kitchen Lay-in Ceiling Tile
  - MMRGB Moisture and Mould-Resistant Gypsum Board
  - SACT Security Acoustic Ceiling Tile
- WALL FINISHES LEGEND:**
- EWC Epoxy Wall Coating
  - HPC High Performance Coating
  - PT Paint
- CEILING FINISHES LEGEND:**
- ECC Epoxy Ceiling Coating
  - HPC High Performance Coating
  - PF Prefinished
  - PT Paint
- WALL PROTECTION LEGEND:**
- ESRP Extruded Semi-Rigid PVCu Panel
  - FRL Fibre Reinforced Laminate
  - FRP Fibreglass Reinforced Plastic
  - PVV Protective Vinyl Wallcovering
  - RHIS Rigid High Impact Sheet
  - WSSP Wetwall Solid Surface Panel
  - WVV Wetroom Vinyl Wallcovering
- FLOOR FINISHES LEGEND:**
- CFS Concrete Floor Sealer
  - EFC Epoxy Floor Coating
  - PFC Polyurethane Floor Coating
  - RAF Rubber Athletic Flooring
  - RSF Rubber Sheet Flooring
  - SCF Seamless Cushioned Flooring
  - SDRF Static-Dissipative Rubber Sheet Flooring
  - SDVF Static-Dissipative Vinyl Sheet Flooring
  - VSF Vinyl Sheet Flooring
  - WSVF Wetroom Safety Vinyl Sheet Flooring
- FLOOR BASE LEGEND:**
- FCB Flash Cove Base
  - RB Rubber Base
  - SCF Seamless Cushioned Flooring

**DOORS**

Types:

Type	Qty	Size (mm)	Material	Finish	Side Lt.	Blinds	Protect.	Privacy Film	Function	Card Reader	Mag Lock	Auto Opener	Hold Open	Hinges	Accessory 1	Accessory 2	Accessory 3	Closer
J	2	1830 x 2135	Aluminum	Prefinished	<input type="checkbox"/>	<input type="checkbox"/>		<input type="checkbox"/>		<input checked="" type="checkbox"/>	<input type="checkbox"/>	<input checked="" type="checkbox"/>	<input type="checkbox"/>					

Door Remarks:  Security Grille  Anti-barricade strategy

**MILLWORK AND SPECIALTY CASEWORK**

**UPPER UNITS** (U1-U8) **LOWER UNITS** (L1-L12) **RECEPTION/TRANSACTION COUNTER / CARE TEAM STATION DESK** (TC1-TC2) **UTILITY SINK AND COUNTER UNIT** (UC1)

Storage Requirements:

**FINISHES**

Full-height Cabinet:   
 Upper Millwork:   
 Countertop:   
 Lower Millwork:   
 Shelf:

Remarks:

**Legend:**

Category	Min. Length (mm)	Motorized Adjustable Height	Standing Height	Specialty Casework
Category 0 - None				
Category 1 - Low (1% - 4%)				
Category 2 - Med (5% - 9%)				
Category 3 - High (10% or Greater)				

**MECHANICAL REQUIREMENTS**

<b>PLUMBING</b> (Quantity) Hand Hygiene Sink: <input type="text"/> Lavatory: <input type="text"/> Kitchen Sink: <input type="text"/> Seamless Kitchen Sink: <input type="text"/> Utility / Process Sink: <input type="text"/> Scrub Sink: <input type="text"/> Floor Sink: <input type="text"/> Plumbing Remarks: <input type="text"/>	Other Fixtures: <input type="checkbox"/> Shower <input type="checkbox"/> Eyewash Station <input type="checkbox"/> Tub <input type="checkbox"/> Eyewash/Shower Station <input type="checkbox"/> Ice Maker <input type="checkbox"/> Emergency Shower <input type="checkbox"/> Water Closet <input type="checkbox"/> Flush Rim Sink <input type="checkbox"/> Instantaneous Hot Water <input type="checkbox"/> Floor Drain <input type="checkbox"/> Water Bottle Refill Station Other <input type="text"/>	<b>MED / NON-MED GASES</b> (Quantity) Oxygen: <input type="text"/> Medical Air: <input type="text"/> Medical Vacuum: <input type="text"/> Nitrous Oxide: <input type="text"/> CO2: <input type="text"/> AGSS: <input type="text"/> Nitrogen: <input type="text"/> Laboratory Air: <input type="text"/> Laboratory Vacuum: <input type="text"/> Utility Compressed Air: <input type="text"/> Gas Remarks: <input type="text"/>
---	---	---

**Appendix 1B Minimum Room Requirements**

Room Name:

Program Number(s):

1. C1.01	7.	13.	19.	25.	31.	37.	43.
2.	8.	14.	20.	26.	32.	38.	44.
3.	9.	15.	21.	27.	33.	39.	45.
4.	10.	16.	22.	28.	34.	40.	46.
5.	11.	17.	23.	29.	35.	41.	47.
6.	12.	18.	24.	30.	36.	42.	48.

**ARCHITECTURAL REQUIREMENTS**

<b>WALL AND CEILING</b> Wall Material: <input type="text" value="GB"/> Finish: <input type="text" value="PT"/> Ceiling Material: <input type="text" value="ACT"/> Finish: <input type="text" value="PF"/>	<b>WALL PROTECTION</b> Type: <input type="text" value="PVW"/> <input checked="" type="checkbox"/> Corner Guards <input checked="" type="checkbox"/> Hand Rails <input type="checkbox"/> Bed Bumper / Locator Height: <input type="text" value="2185 mm"/> <input type="checkbox"/> Crash Rails <input type="checkbox"/> Chair Rail	<b>GLAZING</b> <input checked="" type="checkbox"/> Interior Glazing	<b>FLOORING TYPES</b> Material: <input type="text" value="VSF"/> Base: <input type="text" value="FCB"/>	<b>ROOM ACCESSORIES</b> <input type="checkbox"/> Coat Hooks <input type="checkbox"/> Ceiling Lift <input type="checkbox"/> Magnetic Whiteboard <input type="checkbox"/> Mirror <input type="checkbox"/> Infant Change Table <input type="checkbox"/> Privacy Curtain
---	--	--	--	--

- LEGEND:**
- WALL AND CEILING LEGEND:**
- AC Architectural Ceiling
  - ACT Acoustic Ceiling Tile
  - ACT-C Cleanroom
  - ARGB Abuse-Resistant Gypsum Board
  - GB Gypsum Board
  - IRGB Impact-Resistant Gypsum Board
  - KLCT Kitchen Lay-in Ceiling Tile
  - MMRGB Moisture and Mould-Resistant Gypsum Board
  - SACT Security Acoustic Ceiling Tile
- WALL FINISHES LEGEND:**
- EWC Epoxy Wall Coating
  - HPC High Performance Coating
  - PT Paint
- CEILING FINISHES LEGEND:**
- ECC Epoxy Ceiling Coating
  - HPC High Performance Coating
  - PF Prefinished
  - PT Paint
- WALL PROTECTION LEGEND:**
- ESRP Extruded Semi-Rigid PVCu Panel
  - FRL Fibre Reinforced Laminate
  - FRP Fibreglass Reinforced Plastic
  - PVW Protective Vinyl Wallcovering
  - RHIS Rigid High Impact Sheet
  - WSSP Wetwall Solid Surface Panel
  - WVV Wetroom Vinyl Wallcovering
- FLOOR FINISHES LEGEND:**
- CFS Concrete Floor Sealer
  - EFC Epoxy Floor Coating
  - PFC Polyurethane Floor Coating
  - RAF Rubber Athletic Flooring
  - RSF Rubber Sheet Flooring
  - SCF Seamless Cushioned Flooring
  - SDRF Static-Dissipative Rubber Sheet Flooring
  - SDVF Static-Dissipative Vinyl Sheet Flooring
  - VSF Vinyl Sheet Flooring
  - WSVF Wetroom Safety Vinyl Sheet Flooring
- FLOOR BASE LEGEND:**
- FCB Flash Cove Base
  - RB Rubber Base
  - SCF Seamless Cushioned Flooring

**DOORS**

Types:

Type	Qty	Size (mm)	Material	Finish	Side Lt.	Blinds	Protect.	Privacy Film	Function	Card Reader	Mag Lock	Auto Opener	Hold Open	Hinges	Accessory 1	Accessory 2	Accessory 3	Closer
E2	1	1830 x 2135	Aluminum	Prefinished	<input type="checkbox"/>	<input type="checkbox"/>		<input type="checkbox"/>	Classroom	<input checked="" type="checkbox"/>	<input type="checkbox"/>	<input checked="" type="checkbox"/>	<input checked="" type="checkbox"/>	Butt Hinge	Elec. Strike			Surface
E2	1	1830 x 2135	Aluminum	Prefinished	<input type="checkbox"/>	<input type="checkbox"/>		<input type="checkbox"/>	Push/Pull	<input type="checkbox"/>	<input type="checkbox"/>	<input checked="" type="checkbox"/>	<input checked="" type="checkbox"/>	Butt Hinge	Elec. Strike			Surface

Door Remarks:  Security Grille  Anti-barricade strategy

**MILLWORK AND SPECIALTY CASEWORK**

Storage Requirements:

**FINISHES**

Full-height Cabinet:

Upper Millwork:

Countertop:

Lower Millwork:

Shelf:

Remarks:

**Legend:**

Category	Min. Length (mm)	Motorized Adjustable Height	Standing Height	Specialty Casework
Category 0 - None		<input type="checkbox"/>	<input type="checkbox"/>	<input type="checkbox"/>
Category 1 - Low (1% - 4%)		<input type="checkbox"/>	<input type="checkbox"/>	<input type="checkbox"/>
Category 2 - Med (5% - 9%)		<input type="checkbox"/>	<input type="checkbox"/>	<input type="checkbox"/>
Category 3 - High (10% or Greater)		<input type="checkbox"/>	<input type="checkbox"/>	<input type="checkbox"/>

**MECHANICAL REQUIREMENTS**

<b>PLUMBING</b> (Quantity) Hand Hygiene Sink: <input type="text"/> Lavatory: <input type="text"/> Kitchen Sink: <input type="text"/> Seamless Kitchen Sink: <input type="text"/> Utility / Process Sink: <input type="text"/> Scrub Sink: <input type="text"/> Floor Sink: <input type="text"/> Plumbing Remarks: <input type="text"/>	Other Fixtures: <input type="checkbox"/> Shower <input type="checkbox"/> Tub <input type="checkbox"/> Ice Maker <input type="checkbox"/> Water Closet <input type="checkbox"/> Instantaneous Hot Water <input type="checkbox"/> Eyewash Station <input type="checkbox"/> Eyewash/Shower Station <input type="checkbox"/> Emergency Shower <input type="checkbox"/> Flush Rim Sink <input type="checkbox"/> Floor Drain <input type="checkbox"/> Water Bottle Refill Station Other: <input type="text"/>	<b>MED / NON-MED GASES</b> (Quantity) Oxygen: <input type="text"/> Medical Air: <input type="text"/> Medical Vacuum: <input type="text"/> Nitrous Oxide: <input type="text"/> CO2: <input type="text"/> AGSS: <input type="text"/> Nitrogen: <input type="text"/> Laboratory Air: <input type="text"/> Laboratory Vacuum: <input type="text"/> Utility Compressed Air: <input type="text"/> Gas Remarks: <input type="text"/>
---	--	---



**Appendix 1B Minimum Room Requirements**

Room Name:

Program Number(s):

1. C3.06.01	7.	13.	19.	25.	31.	37.	43.
2. C4.02.01	8.	14.	20.	26.	32.	38.	44.
3. C5.01	9.	15.	21.	27.	33.	39.	45.
4.	10.	16.	22.	28.	34.	40.	46.
5.	11.	17.	23.	29.	35.	41.	47.
6.	12.	18.	24.	30.	36.	42.	48.

**ARCHITECTURAL REQUIREMENTS**

<b>WALL AND CEILING</b> Wall Material: <input type="text" value="ARGB 1.2m AFF, GB above"/> Finish: <input type="text" value="PT"/> Ceiling Material: <input type="text" value="ACT"/> Finish: <input type="text" value="PF"/>	<b>WALL PROTECTION</b> Type: <input type="text" value="FRL"/> <input checked="" type="checkbox"/> Corner Guards <input type="checkbox"/> Hand Rails <input type="checkbox"/> Bed Bumper / Locator Height: <input type="text" value="1350 mm"/> <input type="checkbox"/> Crash Rails <input checked="" type="checkbox"/> Chair Rail	<b>GLAZING</b> <input checked="" type="checkbox"/> Interior Glazing	<b>FLOORING TYPES</b> Material: <input type="text" value="VSF"/> Base: <input type="text" value="FCB"/>	<b>ROOM ACCESSORIES</b> <input type="checkbox"/> Coat Hooks <input type="checkbox"/> Ceiling Lift <input type="checkbox"/> Magnetic Whiteboard <input type="checkbox"/> Mirror <input type="checkbox"/> Infant Change Table <input type="checkbox"/> Privacy Curtain
--	--	--	--	--

- LEGEND:**
- WALL AND CEILING LEGEND:**
- AC Architectural Ceiling
  - ACT Acoustic Ceiling Tile
  - ACT-C Cleanroom
  - ARGB Abuse-Resistant Gypsum Board
  - GB Gypsum Board
  - IRGB Impact-Resistant Gypsum Board
  - KLCT Kitchen Lay-in Ceiling Tile
  - MMRGB Moisture and Mould-Resistant Gypsum Board
  - SACT Security Acoustic Ceiling Tile
- WALL FINISHES LEGEND:**
- EWC Epoxy Wall Coating
  - HPC High Performance Coating
  - PT Paint
- CEILING FINISHES LEGEND:**
- ECC Epoxy Ceiling Coating
  - HPC High Performance Coating
  - PF Prefinished
  - PT Paint
- WALL PROTECTION LEGEND:**
- ESRP Extruded Semi-Rigid PVCu Panel
  - FRL Fibre Reinforced Laminate
  - FRP Fibreglass Reinforced Plastic
  - PVV Protective Vinyl Wallcovering
  - RHIS Rigid High Impact Sheet
  - WSSP Wetwall Solid Surface Panel
  - WVV Wetroom Vinyl Wallcovering
- FLOOR FINISHES LEGEND:**
- CFS Concrete Floor Sealer
  - EFC Epoxy Floor Coating
  - PFC Polyurethane Floor Coating
  - RAF Rubber Athletic Flooring
  - RSF Rubber Sheet Flooring
  - SCF Seamless Cushioned Flooring
  - SDRF Static-Dissipative Rubber Sheet Flooring
  - SDVF Static-Dissipative Vinyl Sheet Flooring
  - VSF Vinyl Sheet Flooring
  - WSVF Wetroom Safety Vinyl Sheet Flooring
- FLOOR BASE LEGEND:**
- FCB Flash Cove Base
  - RB Rubber Base
  - SCF Seamless Cushioned Flooring

**DOORS**

Types:

Type:Qty:	Size (mm):	Material:	Finish:	Side Lt:	Blinds:	Protect.:	Privacy Film:	Function:	Card Reader:	Mag Lock:	Auto Opener:	Hold Open:	Hinges:	Accessory 1:	Accessory 2:	Accessory 3:	Closer:
				<input type="checkbox"/>	<input type="checkbox"/>		<input type="checkbox"/>	Push/Pull	<input type="checkbox"/>	<input type="checkbox"/>	<input type="checkbox"/>	<input type="checkbox"/>	Butt Hinge				Surface

Door Remarks:  Security Grille  Anti-barricade strategy

**MILLWORK AND SPECIALTY CASEWORK**

Storage Requirements:

**UPPER UNITS** (U1-U8) **SHELF** (S1)

**FULL-HEIGHT CABINETS** (C1-C5) **LOWER UNITS** (L1-L12) **RECEPTION/TRANSACTION COUNTER / CARE TEAM STATION DESK** (TC1-TC2) **UTILITY SINK AND COUNTER UNIT** (UC1)

Category	Min. Length (mm)	Motorized Adjustable Height	Standing Height	Specialty Casework
Category 0 - None		<input type="checkbox"/>	<input type="checkbox"/>	<input type="checkbox"/>
Category 1 - Low (1% - 4%)		<input type="checkbox"/>	<input type="checkbox"/>	<input type="checkbox"/>
Category 2 - Med (5% - 9%)		<input type="checkbox"/>	<input type="checkbox"/>	<input type="checkbox"/>
Category 3 - High (10% or Greater)		<input type="checkbox"/>	<input type="checkbox"/>	<input type="checkbox"/>

**FINISHES**

Full-height Cabinet:   
 Upper Millwork:   
 Countertop:   
 Lower Millwork:   
 Shelf:

Remarks:

**MECHANICAL REQUIREMENTS**

<b>PLUMBING</b> (Quantity) Hand Hygiene Sink: <input type="text"/> Lavatory: <input type="text"/> Kitchen Sink: <input type="text"/> Seamless Kitchen Sink: <input type="text"/> Utility / Process Sink: <input type="text"/> Scrub Sink: <input type="text"/> Floor Sink: <input type="text"/> Plumbing Remarks: <input type="text"/>	Other Fixtures: <input type="checkbox"/> Shower <input type="checkbox"/> Eyewash Station <input type="checkbox"/> Tub <input type="checkbox"/> Eyewash/Shower Station <input type="checkbox"/> Ice Maker <input type="checkbox"/> Emergency Shower <input type="checkbox"/> Water Closet <input type="checkbox"/> Flush Rim Sink <input type="checkbox"/> Instantaneous Hot Water <input type="checkbox"/> Floor Drain <input type="checkbox"/> <input type="checkbox"/> Water Bottle Refill Station Other <input type="text"/>	<b>MED / NON-MED GASES</b> (Quantity) Oxygen: <input type="text"/> Medical Air: <input type="text"/> Medical Vacuum: <input type="text"/> Nitrous Oxide: <input type="text"/> CO2: <input type="text"/> AGSS: <input type="text"/> Nitrogen: <input type="text"/> Laboratory Air: <input type="text"/> Laboratory Vacuum: <input type="text"/> Utility Compressed Air: <input type="text"/> Gas Remarks: <input type="text"/>
---	--	---



# Appendix 1B Minimum Room Requirements

Room Name:

Program Number(s):	1. C4.05	7.	13.	19.	25.	31.	37.	43.
	2.	8.	14.	20.	26.	32.	38.	44.
	3.	9.	15.	21.	27.	33.	39.	45.
	4.	10.	16.	22.	28.	34.	40.	46.
	5.	11.	17.	23.	29.	35.	41.	47.
	6.	12.	18.	24.	30.	36.	42.	48.

## ARCHITECTURAL REQUIREMENTS

<b>WALL AND CEILING</b> Wall Material: <input type="text" value="ARGB 1.2m AFF, GB above"/> Finish: <input type="text" value="PT"/> Ceiling Material: <input type="text" value="ACT"/> Finish: <input type="text" value="PF"/>	<b>WALL PROTECTION</b> Type: <input type="text" value="FRL"/> <input checked="" type="checkbox"/> Corner Guards <input type="checkbox"/> Hand Rails <input type="checkbox"/> Bed Bumper / Locator Height: <input type="text" value="1350 mm"/> <input type="checkbox"/> Crash Rails <input checked="" type="checkbox"/> Chair Rail	<b>GLAZING</b> <input checked="" type="checkbox"/> Interior Glazing	<b>FLOORING TYPES</b> Material: <input type="text" value="VSF"/> Base: <input type="text" value="FCB"/>	<b>ROOM ACCESSORIES</b> <input type="checkbox"/> Coat Hooks <input type="checkbox"/> Ceiling Lift <input type="checkbox"/> Magnetic Whiteboard <input type="checkbox"/> Mirror <input type="checkbox"/> Infant Change Table <input type="checkbox"/> Privacy Curtain
--	--	--	--	--

- LEGEND:**
- WALL AND CEILING LEGEND:**
- AC Architectural Ceiling
  - ACT Acoustic Ceiling Tile
  - ACT-C Cleanroom
  - ARGB Abuse-Resistant Gypsum Board
  - GB Gypsum Board
  - IRGB Impact-Resistant Gypsum Board
  - KLCT Kitchen Lay-in Ceiling Tile
  - MMRGB Moisture and Mould-Resistant Gypsum Board
  - SACT Security Acoustic Ceiling Tile
- WALL FINISHES LEGEND:**
- EWC Epoxy Wall Coating
  - HPC High Performance Coating
  - PT Paint
- CEILING FINISHES LEGEND:**
- ECC Epoxy Ceiling Coating
  - HPC High Performance Coating
  - PF Prefinished
  - PT Paint
- WALL PROTECTION LEGEND:**
- ESRP Extruded Semi-Rigid PVCu Panel
  - FRL Fibre Reinforced Laminate
  - FRP Fibreglass Reinforced Plastic
  - PVV Protective Vinyl Wallcovering
  - RHIS Rigid High Impact Sheet
  - WSSP Wetwall Solid Surface Panel
  - WVV Wetroom Vinyl Wallcovering
- FLOOR FINISHES LEGEND:**
- CFS Concrete Floor Sealer
  - EFC Epoxy Floor Coating
  - PFC Polyurethane Floor Coating
  - RAF Rubber Athletic Flooring
  - RSF Rubber Sheet Flooring
  - SCF Seamless Cushioned Flooring
  - SDRF Static-Dissipative Rubber Sheet Flooring
  - SDVF Static-Dissipative Vinyl Sheet Flooring
  - VSF Vinyl Sheet Flooring
  - WSVF Wetroom Safety Vinyl Sheet Flooring
- FLOOR BASE LEGEND:**
- FCB Flash Cove Base
  - RB Rubber Base
  - SCF Seamless Cushioned Flooring

**DOORS**

Types:

Type:Qty:	Size (mm):	Material:	Finish:	Side Lt:	Blinds:	Protect.:	Privacy Film:	Function:	Card Reader:	Mag Lock:	Auto Opener:	Hold Open:	Hinges:	Accessory 1:	Accessory 2:	Accessory 3:	Closer:

Door Remarks:  Security Grille  Anti-barricade strategy

**MILLWORK AND SPECIALTY CASEWORK**

**UPPER UNITS** (U1-U8) **LOWER UNITS** (L1-L12) **RECEPTION/TRANSACTION COUNTER / CARE TEAM STATION DESK** (TC1-TC2) **UTILITY SINK AND COUNTER UNIT** (UC1)

Storage Requirements:

**FINISHES**

Full-height Cabinet:   
 Upper Millwork:   
 Countertop:   
 Lower Millwork:   
 Shelf:

Remarks:

Category	Min. Length (mm)	Motorized Adjustable Height	Standing Height	Specialty Casework

**Legend:**  
 Category 0 - None  
 Category 1 - Low (1% - 4%)  
 Category 2 - Med (5% - 9%)  
 Category 3 - High (10% or Greater)

## MECHANICAL REQUIREMENTS

<b>PLUMBING</b> (Quantity) Hand Hygiene Sink: <input type="text"/> Lavatory: <input type="text"/> Kitchen Sink: <input type="text"/> Seamless Kitchen Sink: <input type="text"/> Utility / Process Sink: <input type="text"/> Scrub Sink: <input type="text"/> Floor Sink: <input type="text"/> Plumbing Remarks: <input type="text"/>	Other Fixtures: <input type="checkbox"/> Shower <input type="checkbox"/> Eyewash Station <input type="checkbox"/> Tub <input type="checkbox"/> Eyewash/Shower Station <input type="checkbox"/> Ice Maker <input type="checkbox"/> Emergency Shower <input type="checkbox"/> Water Closet <input type="checkbox"/> Flush Rim Sink <input type="checkbox"/> Instantaneous Hot Water <input type="checkbox"/> Floor Drain <input type="checkbox"/> <input type="checkbox"/> Water Bottle Refill Station Other: <input type="text"/>	<b>MED / NON-MED GASES</b> (Quantity) Oxygen: <input type="text"/> Medical Air: <input type="text"/> Medical Vacuum: <input type="text"/> Nitrous Oxide: <input type="text"/> CO2: <input type="text"/> AGSS: <input type="text"/> Nitrogen: <input type="text"/> Laboratory Air: <input type="text"/> Laboratory Vacuum: <input type="text"/> Utility Compressed Air: <input type="text"/> Gas Remarks: <input type="text"/>
---	---	---

**Appendix 1B Minimum Room Requirements**

Room Name:

Program Number(s):

1. C3.06.02	7.	13.	19.	25.	31.	37.	43.
2. C4.02.02	8.	14.	20.	26.	32.	38.	44.
3.	9.	15.	21.	27.	33.	39.	45.
4.	10.	16.	22.	28.	34.	40.	46.
5.	11.	17.	23.	29.	35.	41.	47.
6.	12.	18.	24.	30.	36.	42.	48.

**ARCHITECTURAL REQUIREMENTS**

<b>WALL AND CEILING</b> Wall Material: <input type="text" value="ARGB 1.2m AFF, GB above"/> Finish: <input type="text" value="PT"/> Ceiling Material: <input type="text" value="ACT"/> Finish: <input type="text" value="PF"/>		<b>WALL PROTECTION</b> Type: <input type="text" value="FRL"/> Height: <input type="text" value="1350 mm"/> <input checked="" type="checkbox"/> Corner Guards <input type="checkbox"/> Hand Rails <input type="checkbox"/> Bed Bumper / Locator <input type="checkbox"/> Crash Rails <input checked="" type="checkbox"/> Chair Rail		<b>GLAZING</b> <input checked="" type="checkbox"/> Interior Glazing		<b>FLOORING TYPES</b> Material: <input type="text" value="VSF"/> Base: <input type="text" value="FCB"/>		<b>ROOM ACCESSORIES</b> <input type="checkbox"/> Coat Hooks <input type="checkbox"/> Ceiling Lift <input type="checkbox"/> Magnetic Whiteboard <input type="checkbox"/> Mirror <input type="checkbox"/> Infant Change Table <input type="checkbox"/> Privacy Curtain	
--	--	---	--	--	--	--	--	--	--

- LEGEND:**
- WALL AND CEILING LEGEND:**
- AC Architectural Ceiling
  - ACT Acoustic Ceiling Tile
  - ACT-C Cleanroom
  - ARGB Abuse-Resistant Gypsum Board
  - GB Gypsum Board
  - IRGB Impact-Resistant Gypsum Board
  - KLCT Kitchen Lay-in Ceiling Tile
  - MMRGB Moisture and Mould-Resistant Gypsum Board
  - SACT Security Acoustic Ceiling Tile
- WALL FINISHES LEGEND:**
- EWC Epoxy Wall Coating
  - HPC High Performance Coating
  - PT Paint
- CEILING FINISHES LEGEND:**
- ECC Epoxy Ceiling Coating
  - HPC High Performance Coating
  - PF Prefinished
  - PT Paint
- WALL PROTECTION LEGEND:**
- ESRP Extruded Semi-Rigid PVCu Panel
  - FRL Fibre Reinforced Laminate
  - FRP Fibreglass Reinforced Plastic
  - PVV Protective Vinyl Wallcovering
  - RHIS Rigid High Impact Sheet
  - WSSP Wetwall Solid Surface Panel
  - WVV Wetroom Vinyl Wallcovering
- FLOOR FINISHES LEGEND:**
- CFS Concrete Floor Sealer
  - EFC Epoxy Floor Coating
  - PFC Polyurethane Floor Coating
  - RAF Rubber Athletic Flooring
  - RSF Rubber Sheet Flooring
  - SCF Seamless Cushioned Flooring
  - SDRF Static-Dissipative Rubber Sheet Flooring
  - SDVF Static-Dissipative Vinyl Sheet Flooring
  - VSF Vinyl Sheet Flooring
  - WSVF Wetroom Safety Vinyl Sheet Flooring
- FLOOR BASE LEGEND:**
- FCB Flash Cove Base
  - RB Rubber Base
  - SCF Seamless Cushioned Flooring

**DOORS**

Types:

Type:Qty:	Size (mm):	Material:	Finish:	Side Lt:	Blinds:	Protect.:	Privacy Film:	Function:	Card Reader:	Mag Lock:	Auto Opener:	Hold Open:	Hinges:	Accessory 1:	Accessory 2:	Accessory 3:	Closer:

Door Remarks:  Security Grille  Anti-barricade strategy

**MILLWORK AND SPECIALTY CASEWORK**

**UPPER UNITS** (U1-U8) **LOWER UNITS** (L1-L9)

**RECEPTION/TRANSACTION COUNTER / CARE TEAM STATION DESK** (TC1, TC2)

**UTILITY SINK AND COUNTER UNIT** (UC1)

**Storage Requirements:**  SHELF (S1)

**FINISHES**

- Full-height Cabinet:
- Upper Millwork:
- Countertop:
- Lower Millwork:
- Shelf:

Remarks: Provide a fixed, modular partition room divider between recliners for infection control.

**MECHANICAL REQUIREMENTS**

<b>PLUMBING</b> (Quantity) Hand Hygiene Sink: <input type="text"/> Lavatory: <input type="text"/> Kitchen Sink: <input type="text"/> Seamless Kitchen Sink: <input type="text"/> Utility / Process Sink: <input type="text"/> Scrub Sink: <input type="text"/> Floor Sink: <input type="text"/>							Other Fixtures: <input type="checkbox"/> Shower <input type="checkbox"/> Tub <input type="checkbox"/> Ice Maker <input type="checkbox"/> Water Closet <input type="checkbox"/> Instantaneous Hot Water				<input type="checkbox"/> Eyewash Station <input type="checkbox"/> Eyewash/Shower Station <input type="checkbox"/> Emergency Shower <input type="checkbox"/> Flush Rim Sink <input type="checkbox"/> Floor Drain <input type="checkbox"/> Water Bottle Refill Station				<b>MED / NON-MED GASES</b> (Quantity) Oxygen: <input type="text" value="1"/> Medical Air: <input type="text" value="1"/> Medical Vacuum: <input type="text" value="1"/> Nitrous Oxide: <input type="text"/> CO2: <input type="text"/> AGSS: <input type="text"/> Nitrogen: <input type="text"/> Laboratory Air: <input type="text"/> Laboratory Vacuum: <input type="text"/> Utility Compressed Air: <input type="text"/>				
Plumbing Remarks: <input type="text"/>							Other: <input type="text"/>				Gas Remarks: Provide one set of (1) O2/(1) Medical Air/(1) Medical Vacuum for each recliner chair to Patient's right. C3.06.02 - Provide (3) sets C4.02.02 - Provide (4) sets								

**Appendix 1B Minimum Room Requirements**

Room Name:

Program Number(s):

1. C2.09	7.	13.	19.	25.	31.	37.	43.
2.	8.	14.	20.	26.	32.	38.	44.
3.	9.	15.	21.	27.	33.	39.	45.
4.	10.	16.	22.	28.	34.	40.	46.
5.	11.	17.	23.	29.	35.	41.	47.
6.	12.	18.	24.	30.	36.	42.	48.

**ARCHITECTURAL REQUIREMENTS**

<b>WALL AND CEILING</b> Wall Material: <input type="text" value="MMRGB"/> Finish: <input type="text" value="EWC"/> Ceiling Material: <input type="text" value="MMRGB"/> Finish: <input type="text" value="ECC"/>	<b>WALL PROTECTION</b> Type: <input type="text" value="FRP"/> <input checked="" type="checkbox"/> Corner Guards <input type="checkbox"/> Hand Rails <input type="checkbox"/> Bed Bumper / Locator Height: <input type="text" value="1350 mm"/> <input type="checkbox"/> Crash Rails <input type="checkbox"/> Chair Rail	<b>GLAZING</b> <input type="checkbox"/> Interior Glazing	<b>FLOORING TYPES</b> Material: <input type="text" value="WSVF"/> Base: <input type="text" value="FCB"/>	<b>ROOM ACCESSORIES</b> <input checked="" type="checkbox"/> Coat Hooks <input type="checkbox"/> Ceiling Lift <input type="checkbox"/> Magnetic Whiteboard <input checked="" type="checkbox"/> Mirror <input type="checkbox"/> Infant Change Table <input type="checkbox"/> Privacy Curtain
--	---	---	---	--

- LEGEND:**
- WALL AND CEILING LEGEND:**
- AC Architectural Ceiling
  - ACT Acoustic Ceiling Tile
  - ACT-C Cleanroom
  - ARGB Abuse-Resistant Gypsum Board
  - GB Gypsum Board
  - IRGB Impact-Resistant Gypsum Board
  - KLCT Kitchen Lay-in Ceiling Tile
  - MMRGB Moisture and Mould-Resistant Gypsum Board
  - SACT Security Acoustic Ceiling Tile
- WALL FINISHES LEGEND:**
- EWC Epoxy Wall Coating
  - HPC High Performance Coating
  - PT Paint
- CEILING FINISHES LEGEND:**
- ECC Epoxy Ceiling Coating
  - HPC High Performance Coating
  - PF Prefinished
  - PT Paint
- WALL PROTECTION LEGEND:**
- ESRP Extruded Semi-Rigid PVCu Panel
  - FRL Fibre Reinforced Laminate
  - FRP Fibreglass Reinforced Plastic
  - PVV Protective Vinyl Wallcovering
  - RHIS Rigid High Impact Sheet
  - WSSP Wetwall Solid Surface Panel
  - WVV Wetroom Vinyl Wallcovering
- FLOOR FINISHES LEGEND:**
- CFS Concrete Floor Sealer
  - EFC Epoxy Floor Coating
  - PFC Polyurethane Floor Coating
  - RAF Rubber Athletic Flooring
  - RSF Rubber Sheet Flooring
  - SCF Seamless Cushioned Flooring
  - SDRF Static-Dissipative Rubber Sheet Flooring
  - SDVF Static-Dissipative Vinyl Sheet Flooring
  - VSF Vinyl Sheet Flooring
  - WSVF Wetroom Safety Vinyl Sheet Flooring
- FLOOR BASE LEGEND:**
- FCB Flash Cove Base
  - RB Rubber Base
  - SCF Seamless Cushioned Flooring

**DOORS**

Types:

Type	Qty	Size (mm)	Material	Finish	Side Lt.	Blinds	Protect.	Privacy Film	Function	Card Reader	Mag Lock	Auto Opener	Hold Open	Hinges	Accessory 1	Accessory 2	Accessory 3	Closer
A	1	1065 x 2135	Solid Core	FRL	<input type="checkbox"/>	<input type="checkbox"/>	1 Low	<input type="checkbox"/>	Privacy	<input type="checkbox"/>	<input type="checkbox"/>	<input type="checkbox"/>	<input type="checkbox"/>	Cont. Double-Acting	Safety Stop			Surface

Door Remarks:  Security Grille  Anti-barricade strategy

**MILLWORK AND SPECIALTY CASEWORK**

**UPPER UNITS** (U1-U8) **LOWER UNITS** (L1-L9)

**RECEPTION/TRANSACTION COUNTER / CARE TEAM STATION DESK** (TC1, TC2)

**UTILITY SINK AND COUNTER UNIT** (UC1)

**Storage Requirements:**  SHELF S1

**FINISHES**

- Full-height Cabinet:
- Upper Millwork:
- Countertop:
- Lower Millwork:
- Shelf:

Remarks:

**Legend:**

Category	Min. Length (mm)	Motorized Adjustable Height	Standing Height	Specialty Casework
2	600	<input type="checkbox"/>	<input type="checkbox"/>	<input type="checkbox"/>

**MECHANICAL REQUIREMENTS**

<b>PLUMBING</b> (Quantity) Hand Hygiene Sink: <input type="text"/> Lavatory: <input type="text" value="1"/> Kitchen Sink: <input type="text"/> Seamless Kitchen Sink: <input type="text"/> Utility / Process Sink: <input type="text"/> Scrub Sink: <input type="text"/> Floor Sink: <input type="text"/> Plumbing Remarks: <input type="text"/>	Other Fixtures: <input type="checkbox"/> Shower <input type="checkbox"/> Tub <input type="checkbox"/> Ice Maker <input checked="" type="checkbox"/> Water Closet <input type="checkbox"/> Instantaneous Hot Water <input type="checkbox"/> Eyewash Station <input type="checkbox"/> Eyewash/Shower Station <input type="checkbox"/> Emergency Shower <input type="checkbox"/> Flush Rim Sink <input type="checkbox"/> Floor Drain <input type="checkbox"/> Water Bottle Refill Station Other: <input type="text"/>	<b>MED / NON-MED GASES</b> (Quantity) Oxygen: <input type="text"/> Medical Air: <input type="text"/> Medical Vacuum: <input type="text"/> Nitrous Oxide: <input type="text"/> CO2: <input type="text"/> AGSS: <input type="text"/> Nitrogen: <input type="text"/> Laboratory Air: <input type="text"/> Laboratory Vacuum: <input type="text"/> Utility Compressed Air: <input type="text"/> Gas Remarks: <input type="text"/>
--	---	---



---

# New Surrey Hospital & BC Cancer Centre

MINIMUM ROOM REQUIREMENTS

## D. Perioperative

---

**Appendix 1B Minimum Room Requirements**

Room Name:

Program Number(s):

1. D4.02.02	7.	13.	19.	25.	31.	37.	43.
2.	8.	14.	20.	26.	32.	38.	44.
3.	9.	15.	21.	27.	33.	39.	45.
4.	10.	16.	22.	28.	34.	40.	46.
5.	11.	17.	23.	29.	35.	41.	47.
6.	12.	18.	24.	30.	36.	42.	48.

**ARCHITECTURAL REQUIREMENTS**

<b>WALL AND CEILING</b> Wall Material: <input type="text" value="ARGB 1.2m AFF, GB above"/> Finish: <input type="text" value="PT"/> Ceiling Material: <input type="text" value="ACT"/> Finish: <input type="text" value="PF"/>	<b>WALL PROTECTION</b> Type: <input type="text" value="PVW"/> <input checked="" type="checkbox"/> Corner Guards <input type="checkbox"/> Hand Rails <input type="checkbox"/> Bed Bumper / Locator Height: <input type="text" value="2185 mm"/> <input checked="" type="checkbox"/> Crash Rails <input type="checkbox"/> Chair Rail	<b>GLAZING</b> <input type="checkbox"/> Interior Glazing	<b>FLOORING TYPES</b> Material: <input type="text" value="VSF"/> Base: <input type="text" value="FCB"/>	<b>ROOM ACCESSORIES</b> <input type="checkbox"/> Coat Hooks <input type="checkbox"/> Ceiling Lift <input checked="" type="checkbox"/> Magnetic Whiteboard <input type="checkbox"/> Mirror <input type="checkbox"/> Infant Change Table <input type="checkbox"/> Privacy Curtain
--	--	---	--	---

- LEGEND:**
- WALL AND CEILING LEGEND:**
- AC Architectural Ceiling
  - ACT Acoustic Ceiling Tile
  - ACT-C Cleanroom
  - ARGB Abuse-Resistant Gypsum Board
  - GB Gypsum Board
  - IRGB Impact-Resistant Gypsum Board
  - KLCT Kitchen Lay-in Ceiling Tile
  - MMRGB Moisture and Mould-Resistant Gypsum Board
  - SACT Security Acoustic Ceiling Tile
- WALL FINISHES LEGEND:**
- EWC Epoxy Wall Coating
  - HPC High Performance Coating
  - PT Paint
- CEILING FINISHES LEGEND:**
- ECC Epoxy Ceiling Coating
  - HPC High Performance Coating
  - PF Prefinished
  - PT Paint
- WALL PROTECTION LEGEND:**
- ESRP Extruded Semi-Rigid PVCu Panel
  - FRL Fibre Reinforced Laminate
  - FRP Fibreglass Reinforced Plastic
  - PVW Protective Vinyl Wallcovering
  - RHIS Rigid High Impact Sheet
  - WSSP Wetwall Solid Surface Panel
  - WVV Wetroom Vinyl Wallcovering
- FLOOR FINISHES LEGEND:**
- CFS Concrete Floor Sealer
  - EFC Epoxy Floor Coating
  - PFC Polyurethane Floor Coating
  - RAF Rubber Athletic Flooring
  - RSF Rubber Sheet Flooring
  - SCF Seamless Cushioned Flooring
  - SDRF Static-Dissipative Rubber Sheet Flooring
  - SDVF Static-Dissipative Vinyl Sheet Flooring
  - VSF Vinyl Sheet Flooring
  - WSVF Wetroom Safety Vinyl Sheet Flooring
- FLOOR BASE LEGEND:**
- FCB Flash Cove Base
  - RB Rubber Base
  - SCF Seamless Cushioned Flooring

**DOORS**

Types:

Type	Qty	Size (mm)	Material	Finish	Side Lt.	Blinds	Protect.	Privacy Film	Function	Card Reader	Mag Lock	Auto Opener	Hold Open	Hinges	Accessory 1	Accessory 2	Accessory 3	Closer	

Door Remarks:  Security Grille  Anti-barricade strategy

**MILLWORK AND SPECIALTY CASEWORK**

**UPPER UNITS** (U1-U8) **LOWER UNITS** (L1-L12) **RECEPTION/TRANSACTION COUNTER / CARE TEAM STATION DESK** (TC1-TC2) **UTILITY SINK AND COUNTER UNIT** (UC1)

Storage Requirements:

**FINISHES**

Full-height Cabinet:   
 Upper Millwork:   
 Countertop:   
 Lower Millwork:   
 Shelf:

Remarks:

**Legend:**

Category	Min. Length (mm)	Motorized Adjustable Height	Standing Height	Specialty Casework
Category 0 - None				
Category 1 - Low (1% - 4%)				
Category 2 - Med (5% - 9%)				
Category 3 - High (10% or Greater)				

**MECHANICAL REQUIREMENTS**

<b>PLUMBING</b> (Quantity) Hand Hygiene Sink: <input type="text"/> Lavatory: <input type="text"/> Kitchen Sink: <input type="text"/> Seamless Kitchen Sink: <input type="text"/> Utility / Process Sink: <input type="text"/> Scrub Sink: <input type="text"/> Floor Sink: <input type="text"/> Plumbing Remarks: <input type="text"/>	Other Fixtures: <input type="checkbox"/> Shower <input type="checkbox"/> Tub <input type="checkbox"/> Ice Maker <input type="checkbox"/> Water Closet <input type="checkbox"/> Instantaneous Hot Water <input type="checkbox"/> Eyewash Station <input type="checkbox"/> Eyewash/Shower Station <input type="checkbox"/> Emergency Shower <input type="checkbox"/> Flush Rim Sink <input type="checkbox"/> Floor Drain <input type="checkbox"/> Water Bottle Refill Station Other <input type="text"/>	<b>MED / NON-MED GASES</b> (Quantity) Oxygen: <input type="text"/> Medical Air: <input type="text"/> Medical Vacuum: <input type="text"/> Nitrous Oxide: <input type="text"/> CO2: <input type="text"/> AGSS: <input type="text"/> Nitrogen: <input type="text"/> Laboratory Air: <input type="text"/> Laboratory Vacuum: <input type="text"/> Utility Compressed Air: <input type="text"/> Gas Remarks: <input type="text"/>
---	---	---

**Appendix 1B Minimum Room Requirements**

Room Name:

Program Number(s):

1. D4.01.01	7.	13.	19.	25.	31.	37.	43.
2.	8.	14.	20.	26.	32.	38.	44.
3.	9.	15.	21.	27.	33.	39.	45.
4.	10.	16.	22.	28.	34.	40.	46.
5.	11.	17.	23.	29.	35.	41.	47.
6.	12.	18.	24.	30.	36.	42.	48.

**ARCHITECTURAL REQUIREMENTS**

<b>WALL AND CEILING</b> Wall Material: <input type="text" value="ARGB 1.2m AFF, GB above"/> Finish: <input type="text" value="EWC"/> Ceiling Material: <input type="text" value="GB"/> Finish: <input type="text" value="ECC"/>	<b>WALL PROTECTION</b> Type: <input type="text" value="PVW"/> <input checked="" type="checkbox"/> Corner Guards <input type="checkbox"/> Hand Rails <input type="checkbox"/> Bed Bumper / Locator Height: <input type="text" value="2185 mm"/> <input checked="" type="checkbox"/> Crash Rails <input type="checkbox"/> Chair Rail	<b>GLAZING</b> <input type="checkbox"/> Interior Glazing	<b>FLOORING TYPES</b> Material: <input type="text" value="WSVF"/> Base: <input type="text" value="FCB"/>	<b>ROOM ACCESSORIES</b> <input type="checkbox"/> Coat Hooks <input type="checkbox"/> Ceiling Lift <input type="checkbox"/> Magnetic Whiteboard <input type="checkbox"/> Mirror <input type="checkbox"/> Infant Change Table <input type="checkbox"/> Privacy Curtain
---	--	---	---	--

- LEGEND:**
- WALL AND CEILING LEGEND:**
- AC Architectural Ceiling
  - ACT Acoustic Ceiling Tile
  - ACT-C Cleanroom
  - ARGB Abuse-Resistant Gypsum Board
  - GB Gypsum Board
  - IRGB Impact-Resistant Gypsum Board
  - KLCT Kitchen Lay-in Ceiling Tile
  - MMRGB Moisture and Mould-Resistant Gypsum Board
  - SACT Security Acoustic Ceiling Tile
- WALL FINISHES LEGEND:**
- EWC Epoxy Wall Coating
  - HPC High Performance Coating
  - PT Paint
- CEILING FINISHES LEGEND:**
- ECC Epoxy Ceiling Coating
  - HPC High Performance Coating
  - PF Prefinished
  - PT Paint
- WALL PROTECTION LEGEND:**
- ESRP Extruded Semi-Rigid PVCu Panel
  - FRL Fibre Reinforced Laminate
  - FRP Fibreglass Reinforced Plastic
  - PVW Protective Vinyl Wallcovering
  - RHIS Rigid High Impact Sheet
  - WSSP Wetwall Solid Surface Panel
  - WVV Wetroom Vinyl Wallcovering
- FLOOR FINISHES LEGEND:**
- CFS Concrete Floor Sealer
  - EFC Epoxy Floor Coating
  - PFC Polyurethane Floor Coating
  - RAF Rubber Athletic Flooring
  - RSF Rubber Sheet Flooring
  - SCF Seamless Cushioned Flooring
  - SDRF Static-Dissipative Rubber Sheet Flooring
  - SDVF Static-Dissipative Vinyl Sheet Flooring
  - VSF Vinyl Sheet Flooring
  - WSVF Wetroom Safety Vinyl Sheet Flooring
- FLOOR BASE LEGEND:**
- FCB Flash Cove Base
  - RB Rubber Base
  - SCF Seamless Cushioned Flooring

**DOORS**

Types:

Type:Qty:	Size (mm):	Material:	Finish:	Side Lt:	Blinds:	Protect.:	Privacy Film:	Function:	Card Reader:	Mag Lock:	Auto Opener:	Hold Open:	Hinges:	Accessory 1:	Accessory 2:	Accessory 3:	Closer:

Door Remarks:  Security Grille  Anti-barricade strategy

**MILLWORK AND SPECIALTY CASEWORK**

Storage Requirements:

**UPPER UNITS** (U1-U8) **SHELF** (S1)

**LOWER UNITS** (L1-L12) **RECEPTION/TRANSACTION COUNTER / CARE TEAM STATION DESK** (TC1, TC2) **UTILITY SINK AND COUNTER UNIT** (UC1)

**FULL-HEIGHT CABINETS** (C1-C5)

**Legend:**

Category	Min. Length (mm)	Motorized Adjustable Height	Standing Height	Specialty Casework
Category 0 - None				
Category 1 - Low (1% - 4%)				
Category 2 - Med (5% - 9%)				
Category 3 - High (10% or Greater)				

**FINISHES**

Full-height Cabinet:   
 Upper Millwork:   
 Countertop:   
 Lower Millwork:   
 Shelf:

Remarks:

**MECHANICAL REQUIREMENTS**

<b>PLUMBING</b> (Quantity) Hand Hygiene Sink: <input type="text"/> Lavatory: <input type="text"/> Kitchen Sink: <input type="text"/> Seamless Kitchen Sink: <input type="text"/> Utility / Process Sink: <input type="text"/> Scrub Sink: <input type="text"/> Floor Sink: <input type="text"/> Plumbing Remarks: <input type="text"/>	Other Fixtures: <input type="checkbox"/> Shower <input type="checkbox"/> Eyewash Station <input type="checkbox"/> Tub <input type="checkbox"/> Eyewash/Shower Station <input type="checkbox"/> Ice Maker <input type="checkbox"/> Emergency Shower <input type="checkbox"/> Water Closet <input type="checkbox"/> Flush Rim Sink <input type="checkbox"/> Instantaneous Hot Water <input type="checkbox"/> Floor Drain <input type="checkbox"/> <input type="checkbox"/> Water Bottle Refill Station Other <input type="text"/>	<b>MED / NON-MED GASES</b> (Quantity) Oxygen: <input type="text"/> Medical Air: <input type="text"/> Medical Vacuum: <input type="text"/> Nitrous Oxide: <input type="text"/> CO2: <input type="text"/> AGSS: <input type="text"/> Nitrogen: <input type="text"/> Laboratory Air: <input type="text"/> Laboratory Vacuum: <input type="text"/> Utility Compressed Air: <input type="text"/> Gas Remarks: <input type="text"/>
---	--	--



**Appendix 1B Minimum Room Requirements**

Room Name:

Program Number(s):

1. D2.21	7.	13.	19.	25.	31.	37.	43.
2. D3.05	8.	14.	20.	26.	32.	38.	44.
3.	9.	15.	21.	27.	33.	39.	45.
4.	10.	16.	22.	28.	34.	40.	46.
5.	11.	17.	23.	29.	35.	41.	47.
6.	12.	18.	24.	30.	36.	42.	48.

**ARCHITECTURAL REQUIREMENTS**

<b>WALL AND CEILING</b> Wall Material: <input type="text" value="ARGB 1.2m AFF, GB above"/> Finish: <input type="text" value="PT"/> Ceiling Material: <input type="text" value="ACT"/> Finish: <input type="text" value="PF"/>		<b>WALL PROTECTION</b> Type: <input type="text" value="PVW"/> <input checked="" type="checkbox"/> Corner Guards <input type="checkbox"/> Hand Rails <input type="checkbox"/> Bed Bumper / Locator Height: <input type="text" value="1600 mm"/> <input checked="" type="checkbox"/> Crash Rails <input type="checkbox"/> Chair Rail		<b>GLAZING</b> <input type="checkbox"/> Interior Glazing		<b>FLOORING TYPES</b> Material: <input type="text" value="VSF"/> Base: <input type="text" value="FCB"/>		<b>ROOM ACCESSORIES</b> <input type="checkbox"/> Coat Hooks <input type="checkbox"/> Ceiling Lift <input type="checkbox"/> Magnetic Whiteboard <input type="checkbox"/> Mirror <input type="checkbox"/> Infant Change Table <input type="checkbox"/> Privacy Curtain	
--	--	--	--	---	--	--	--	--	--

- LEGEND:**
- WALL AND CEILING LEGEND:**
- AC Architectural Ceiling
  - ACT Acoustic Ceiling Tile
  - ACT-C Cleanroom
  - ARGB Abuse-Resistant Gypsum Board
  - GB Gypsum Board
  - IRGB Impact-Resistant Gypsum Board
  - KLCT Kitchen Lay-in Ceiling Tile
  - MMRGB Moisture and Mould-Resistant Gypsum Board
  - SACT Security Acoustic Ceiling Tile
- WALL FINISHES LEGEND:**
- EWC Epoxy Wall Coating
  - HPC High Performance Coating
  - PT Paint
- CEILING FINISHES LEGEND:**
- ECC Epoxy Ceiling Coating
  - HPC High Performance Coating
  - PF Prefinished
  - PT Paint
- WALL PROTECTION LEGEND:**
- ESRP Extruded Semi-Rigid PVCu Panel
  - FRL Fibre Reinforced Laminate
  - FRP Fibreglass Reinforced Plastic
  - PVW Protective Vinyl Wallcovering
  - RHIS Rigid High Impact Sheet
  - WSSP Wetwall Solid Surface Panel
  - WVV Wetroom Vinyl Wallcovering
- FLOOR FINISHES LEGEND:**
- CFS Concrete Floor Sealer
  - EFC Epoxy Floor Coating
  - PFC Polyurethane Floor Coating
  - RAF Rubber Athletic Flooring
  - RSF Rubber Sheet Flooring
  - SCF Seamless Cushioned Flooring
  - SDRF Static-Dissipative Rubber Sheet Flooring
  - SDVF Static-Dissipative Vinyl Sheet Flooring
  - VSF Vinyl Sheet Flooring
  - WSVF Wetroom Safety Vinyl Sheet Flooring
- FLOOR BASE LEGEND:**
- FCB Flash Cove Base
  - RB Rubber Base
  - SCF Seamless Cushioned Flooring

**DOORS**

Types:

Type	Qty	Size (mm)	Material	Finish	Side Lt.	Blinds	Protect.	Privacy Film	Function	Card Reader	Mag Lock	Auto Opener	Hold Open	Hinges	Accessory 1	Accessory 2	Accessory 3	Closer

Door Remarks:  Security Grille  Anti-barricade strategy

**MILLWORK AND SPECIALTY CASEWORK**

Storage Requirements:

**UPPER UNITS** (U1-U8) **SHELF** (S1)

**LOWER UNITS** (L1-L12) **RECEPTION/TRANSACTION COUNTER / CARE TEAM STATION DESK** (TC1, TC2) **UTILITY SINK AND COUNTER UNIT** (UC1)

**FULL-HEIGHT CABINETS** (C1-C5)

**Legend:**

Category	Min. Length (mm)	Motorized Adjustable Height	Standing Height	Specialty Casework
Category 0 - None				
Category 1 - Low (1% - 4%)				
Category 2 - Med (5% - 9%)				
Category 3 - High (10% or Greater)				

**FINISHES**

Full-height Cabinet:   
 Upper Millwork:   
 Countertop:   
 Lower Millwork:   
 Shelf:

Remarks:

**MECHANICAL REQUIREMENTS**

<b>PLUMBING</b> (Quantity) Hand Hygiene Sink: <input type="text"/> Lavatory: <input type="text"/> Kitchen Sink: <input type="text"/> Seamless Kitchen Sink: <input type="text"/> Utility / Process Sink: <input type="text"/> Scrub Sink: <input type="text"/> Floor Sink: <input type="text"/>		Other Fixtures: <input type="checkbox"/> Shower <input type="checkbox"/> Eyewash Station <input type="checkbox"/> Tub <input type="checkbox"/> Eyewash/Shower Station <input type="checkbox"/> Ice Maker <input type="checkbox"/> Emergency Shower <input type="checkbox"/> Water Closet <input type="checkbox"/> Flush Rim Sink <input type="checkbox"/> Instantaneous Hot Water <input type="checkbox"/> Floor Drain <input type="checkbox"/> Water Bottle Refill Station Other: <input type="text"/>		<b>MED / NON-MED GASES</b> (Quantity) Oxygen: <input type="text"/> Medical Air: <input type="text"/> Medical Vacuum: <input type="text"/> Nitrous Oxide: <input type="text"/> CO2: <input type="text"/> AGSS: <input type="text"/> Nitrogen: <input type="text"/> Laboratory Air: <input type="text"/> Laboratory Vacuum: <input type="text"/> Utility Compressed Air: <input type="text"/>	
Plumbing Remarks: <input type="text"/>		Gas Remarks: <input type="text"/>			

**Appendix 1B Minimum Room Requirements**

Room Name:

Program Number(s):

1. D2.13	7.	13.	19.	25.	31.	37.	43.
2.	8.	14.	20.	26.	32.	38.	44.
3.	9.	15.	21.	27.	33.	39.	45.
4.	10.	16.	22.	28.	34.	40.	46.
5.	11.	17.	23.	29.	35.	41.	47.
6.	12.	18.	24.	30.	36.	42.	48.

**ARCHITECTURAL REQUIREMENTS**

<b>WALL AND CEILING</b> Wall Material: <input type="text" value="ARGB 1.2m AFF, GB above"/> Finish: <input type="text" value="PT"/> Ceiling Material: <input type="text" value="ACT"/> Finish: <input type="text" value="PF"/>	<b>WALL PROTECTION</b> Type: <input type="text" value="RHIS"/> <input checked="" type="checkbox"/> Corner Guards <input type="checkbox"/> Hand Rails <input type="checkbox"/> Bed Bumper / Locator Height: <input type="text" value="1350 mm"/> <input checked="" type="checkbox"/> Crash Rails <input type="checkbox"/> Chair Rail	<b>GLAZING</b> <input type="checkbox"/> Interior Glazing	<b>FLOORING TYPES</b> Material: <input type="text" value="VSF"/> Base: <input type="text" value="FCB"/>	<b>ROOM ACCESSORIES</b> <input checked="" type="checkbox"/> Coat Hooks <input type="checkbox"/> Ceiling Lift <input checked="" type="checkbox"/> Magnetic Whiteboard <input type="checkbox"/> Mirror <input type="checkbox"/> Infant Change Table <input checked="" type="checkbox"/> Privacy Curtain
--	---	---	--	---

- LEGEND:**
- WALL AND CEILING LEGEND:**
- AC Architectural Ceiling
  - ACT Acoustic Ceiling Tile
  - ACT-C Cleanroom
  - ARGB Abuse-Resistant Gypsum Board
  - GB Gypsum Board
  - IRGB Impact-Resistant Gypsum Board
  - KLCT Kitchen Lay-in Ceiling Tile
  - MMRGB Moisture and Mould-Resistant Gypsum Board
  - SACT Security Acoustic Ceiling Tile
- WALL FINISHES LEGEND:**
- EWC Epoxy Wall Coating
  - HPC High Performance Coating
  - PT Paint
- CEILING FINISHES LEGEND:**
- ECC Epoxy Ceiling Coating
  - HPC High Performance Coating
  - PF Prefinished
  - PT Paint
- WALL PROTECTION LEGEND:**
- ESRP Extruded Semi-Rigid PVCu Panel
  - FRL Fibre Reinforced Laminate
  - FRP Fibreglass Reinforced Plastic
  - PVV Protective Vinyl Wallcovering
  - RHIS Rigid High Impact Sheet
  - WSSP Wetwall Solid Surface Panel
  - WVV Wetroom Vinyl Wallcovering
- FLOOR FINISHES LEGEND:**
- CFS Concrete Floor Sealer
  - EFC Epoxy Floor Coating
  - PFC Polyurethane Floor Coating
  - RAF Rubber Athletic Flooring
  - RSF Rubber Sheet Flooring
  - SCF Seamless Cushioned Flooring
  - SDRF Static-Dissipative Rubber Sheet Flooring
  - SDVF Static-Dissipative Vinyl Sheet Flooring
  - VSF Vinyl Sheet Flooring
  - WSVF Wetroom Safety Vinyl Sheet Flooring
- FLOOR BASE LEGEND:**
- FCB Flash Cove Base
  - RB Rubber Base
  - SCF Seamless Cushioned Flooring

**DOORS**

Types:

Type	Qty	Size (mm)	Material	Finish	Side Lt.	Blinds	Protect.	Privacy Film	Function	Card Reader	Mag Lock	Auto Opener	Hold Open	Hinges	Accessory 1	Accessory 2	Accessory 3	Closer
H	1	1340 X 2135	Aluminum	Prefinished	<input type="checkbox"/>	<input type="checkbox"/>		<input type="checkbox"/>		<input type="checkbox"/>	<input type="checkbox"/>	<input type="checkbox"/>	<input type="checkbox"/>					

Door Remarks:  Security Grille  Anti-barricade strategy



**MECHANICAL REQUIREMENTS**

<b>PLUMBING</b> (Quantity) Hand Hygiene Sink: <input type="text" value="1"/> Lavatory: <input type="text"/> Kitchen Sink: <input type="text"/> Seamless Kitchen Sink: <input type="text"/> Utility / Process Sink: <input type="text"/> Scrub Sink: <input type="text"/> Floor Sink: <input type="text"/> Plumbing Remarks: <input type="text"/>	Other Fixtures: <input type="checkbox"/> Shower <input type="checkbox"/> Eyewash Station <input type="checkbox"/> Tub <input type="checkbox"/> Eyewash/Shower Station <input type="checkbox"/> Ice Maker <input type="checkbox"/> Emergency Shower <input type="checkbox"/> Water Closet <input type="checkbox"/> Flush Rim Sink <input type="checkbox"/> Instantaneous Hot Water <input type="checkbox"/> Floor Drain <input type="checkbox"/> <input type="checkbox"/> Water Bottle Refill Station Other: <input type="text"/>	<b>MED / NON-MED GASES</b> (Quantity) Oxygen: <input type="text" value="4"/> Medical Air: <input type="text" value="2"/> Medical Vacuum: <input type="text" value="2"/> Nitrous Oxide: <input type="text"/> CO2: <input type="text"/> AGSS: <input type="text"/> Nitrogen: <input type="text"/> Laboratory Air: <input type="text"/> Laboratory Vacuum: <input type="text"/> Utility Compressed Air: <input type="text"/> Gas Remarks: <input type="text" value="Provide (2) O2, (1) Medical Air, (1) Medical Vacuum on each side of bed."/>
---	---	---

**Appendix 1B Minimum Room Requirements**

Room Name:

Program Number(s):

1. D2.02	7.	13.	19.	25.	31.	37.	43.
2. D2.03	8.	14.	20.	26.	32.	38.	44.
3.	9.	15.	21.	27.	33.	39.	45.
4.	10.	16.	22.	28.	34.	40.	46.
5.	11.	17.	23.	29.	35.	41.	47.
6.	12.	18.	24.	30.	36.	42.	48.

**ARCHITECTURAL REQUIREMENTS**

<b>WALL AND CEILING</b> Wall Material: <input type="text" value="ARGB 1.2m AFF, GB above"/> Finish: <input type="text" value="HPC"/> Ceiling Material: <input type="text" value="GB"/> Finish: <input type="text" value="HPC"/>		<b>WALL PROTECTION</b> Type: <input type="text" value="ESRP"/> <input checked="" type="checkbox"/> Corner Guards <input type="checkbox"/> Hand Rails <input type="checkbox"/> Bed Bumper / Locator Height: <input type="text" value="2185 mm"/> <input checked="" type="checkbox"/> Crash Rails <input type="checkbox"/> Chair Rail		<b>GLAZING</b> <input type="checkbox"/> Interior Glazing		<b>FLOORING TYPES</b> Material: <input type="text" value="VSF"/> Base: <input type="text" value="FCB"/>		<b>ROOM ACCESSORIES</b> <input type="checkbox"/> Coat Hooks <input type="checkbox"/> Ceiling Lift <input type="checkbox"/> Magnetic Whiteboard <input type="checkbox"/> Mirror <input type="checkbox"/> Infant Change Table <input type="checkbox"/> Privacy Curtain	
---	--	---	--	---	--	--	--	--	--

- LEGEND:**
- WALL AND CEILING LEGEND:**
- AC Architectural Ceiling
  - ACT Acoustic Ceiling Tile
  - ACT-C Cleanroom
  - ARGB Abuse-Resistant Gypsum Board
  - GB Gypsum Board
  - IRGB Impact-Resistant Gypsum Board
  - KLCT Kitchen Lay-in Ceiling Tile
  - MMRGB Moisture and Mould-Resistant Gypsum Board
  - SACT Security Acoustic Ceiling Tile
- WALL FINISHES LEGEND:**
- EWC Epoxy Wall Coating
  - HPC High Performance Coating
  - PT Paint
- CEILING FINISHES LEGEND:**
- ECC Epoxy Ceiling Coating
  - HPC High Performance Coating
  - PF Prefinished
  - PT Paint
- WALL PROTECTION LEGEND:**
- ESRP Extruded Semi-Rigid PVCu Panel
  - FRL Fibre Reinforced Laminate
  - FRP Fibreglass Reinforced Plastic
  - PVV Protective Vinyl Wallcovering
  - RHIS Rigid High Impact Sheet
  - WSSP Wetwall Solid Surface Panel
  - WVV Wetroom Vinyl Wallcovering
- FLOOR FINISHES LEGEND:**
- CFS Concrete Floor Sealer
  - EFC Epoxy Floor Coating
  - PFC Polyurethane Floor Coating
  - RAF Rubber Athletic Flooring
  - RSF Rubber Sheet Flooring
  - SCF Seamless Cushioned Flooring
  - SDRF Static-Dissipative Rubber Sheet Flooring
  - SDVF Static-Dissipative Vinyl Sheet Flooring
  - VSF Vinyl Sheet Flooring
  - WSVF Wetroom Safety Vinyl Sheet Flooring
- FLOOR BASE LEGEND:**
- FCB Flash Cove Base
  - RB Rubber Base
  - SCF Seamless Cushioned Flooring

**DOORS**

Types:

Type	Qty	Size (mm)	Material	Finish	Side Lt.	Blinds	Protect.	Privacy Film	Function	Card Reader	Mag Lock	Auto Opener	Hold Open	Hinges	Accessory 1	Accessory 2	Accessory 3	Closer
C	2	1220 x 2135	Solid Core	FRL	<input type="checkbox"/>	<input type="checkbox"/>	2 High	<input type="checkbox"/>	Passage	<input type="checkbox"/>	<input type="checkbox"/>	<input type="checkbox"/>	<input checked="" type="checkbox"/>	Butt Hinge				Surface
H	2	1340 X 2135	Aluminum	Prefinished	<input type="checkbox"/>	<input type="checkbox"/>		<input type="checkbox"/>		<input type="checkbox"/>	<input type="checkbox"/>	<input checked="" type="checkbox"/>	<input type="checkbox"/>		Elec. Strike			

**Door Remarks:**  
 Refer to Appendix 1A [Clinical Specifications and Functional Space Requirements], section 2.4 for more room information.  
 Kickplate stainless steel with full door wraparound on jamb and latch side.  
 Provide D2.02 with (2) H doors.  
 Provide D2.03 with (2) C doors.

Security Grille  
 Anti-barricade strategy

**MILLWORK AND SPECIALTY CASEWORK**

**UPPER UNITS:** U1, U2, U3, U4, U5, U6, U7, U8

**LOWER UNITS:** L1, L2, L3, L4, L5, L6, L7, L8, L9, L10, L11, L12

**RECEPTION/TRANSACTION COUNTER / CARE TEAM STATION DESK:** TC1, TC2

**UTILITY SINK AND COUNTER UNIT:** UC1

**SHELF:** S1

**Storage Requirements:**

**FINISHES**

Full-height Cabinet:   
 Upper Millwork:   
 Countertop:   
 Lower Millwork:   
 Shelf:

**Remarks:**

**MECHANICAL REQUIREMENTS**

<b>PLUMBING</b> (Quantity) Hand Hygiene Sink: <input type="text"/> Lavatory: <input type="text"/> Kitchen Sink: <input type="text"/> Seamless Kitchen Sink: <input type="text"/> Utility / Process Sink: <input type="text"/> Scrub Sink: <input type="text"/> Floor Sink: <input type="text"/>							Other Fixtures: <input type="checkbox"/> Shower <input type="checkbox"/> Tub <input type="checkbox"/> Ice Maker <input type="checkbox"/> Water Closet <input type="checkbox"/> Instantaneous Hot Water			<input type="checkbox"/> Eyewash Station <input type="checkbox"/> Eyewash/Shower Station <input type="checkbox"/> Emergency Shower <input type="checkbox"/> Flush Rim Sink <input type="checkbox"/> Floor Drain <input type="checkbox"/> Water Bottle Refill Station Other: <input type="text"/>			<b>MED / NON-MED GASES</b> (Quantity) Oxygen: <input type="text"/> Medical Air: <input type="text"/> Medical Vacuum: <input type="text"/> Nitrous Oxide: <input type="text"/> CO2: <input type="text"/> AGSS: <input type="text"/> Nitrogen: <input type="text"/> Laboratory Air: <input type="text"/> Laboratory Vacuum: <input type="text"/> Utility Compressed Air: <input type="text"/>					
Plumbing Remarks: <input type="text"/>										Gas Remarks: <input type="text"/>								



**Appendix 1B Minimum Room Requirements**

Room Name: Automatic Endoscope Reprocessor (AER)

Program Number(s):

1. D4.01.07	7.	13.	19.	25.	31.	37.	43.
2.	8.	14.	20.	26.	32.	38.	44.
3.	9.	15.	21.	27.	33.	39.	45.
4.	10.	16.	22.	28.	34.	40.	46.
5.	11.	17.	23.	29.	35.	41.	47.
6.	12.	18.	24.	30.	36.	42.	48.

**ARCHITECTURAL REQUIREMENTS**

<b>WALL AND CEILING</b> Wall Material: ARGB 1.2m AFF, GB above Ceiling Material: ACT Finish: EWC Finish: ECC	<b>WALL PROTECTION</b> Type: WVV Height: 2185 mm <input checked="" type="checkbox"/> Corner Guards <input type="checkbox"/> Hand Rails <input type="checkbox"/> Bed Bumper / Locator <input type="checkbox"/> Crash Rails <input type="checkbox"/> Chair Rail	<b>GLAZING</b> <input type="checkbox"/> Interior Glazing	<b>FLOORING TYPES</b> Material: WSVF Base: FCB	<b>ROOM ACCESSORIES</b> <input type="checkbox"/> Coat Hooks <input type="checkbox"/> Ceiling Lift <input checked="" type="checkbox"/> Magnetic Whiteboard <input type="checkbox"/> Mirror <input type="checkbox"/> Infant Change Table <input type="checkbox"/> Privacy Curtain
--	--	---	--	---

- LEGEND:**
- WALL AND CEILING LEGEND:**
- AC Architectural Ceiling
  - ACT Acoustic Ceiling Tile
  - ACT-C Cleanroom
  - ARGB Abuse-Resistant Gypsum Board
  - GB Gypsum Board
  - IRGB Impact-Resistant Gypsum Board
  - KLCT Kitchen Lay-in Ceiling Tile
  - MMRGB Moisture and Mould-Resistant Gypsum Board
  - SACT Security Acoustic Ceiling Tile
- WALL FINISHES LEGEND:**
- EWC Epoxy Wall Coating
  - HPC High Performance Coating
  - PT Paint
- CEILING FINISHES LEGEND:**
- ECC Epoxy Ceiling Coating
  - HPC High Performance Coating
  - PF Prefinished
  - PT Paint
- WALL PROTECTION LEGEND:**
- ESRP Extruded Semi-Rigid PVCu Panel
  - FRL Fibre Reinforced Laminate
  - FRP Fibreglass Reinforced Plastic
  - PVV Protective Vinyl Wallcovering
  - RHIS Rigid High Impact Sheet
  - WSSP Wetwall Solid Surface Panel
  - WVV Wetroom Vinyl Wallcovering
- FLOOR FINISHES LEGEND:**
- CFS Concrete Floor Sealer
  - EFC Epoxy Floor Coating
  - PFC Polyurethane Floor Coating
  - RAF Rubber Athletic Flooring
  - RSF Rubber Sheet Flooring
  - SCF Seamless Cushioned Flooring
  - SDRF Static-Dissipative Rubber Sheet Flooring
  - SDVF Static-Dissipative Vinyl Sheet Flooring
  - VSF Vinyl Sheet Flooring
  - WSVF Wetroom Safety Vinyl Sheet Flooring
- FLOOR BASE LEGEND:**
- FCB Flash Cove Base
  - RB Rubber Base
  - SCF Seamless Cushioned Flooring

**DOORS**

Types:

Type:Qty:	Size (mm):	Material:	Finish:	Side Lt:	Blinds:	Protect.:	Privacy Film:	Function:	Card Reader:	Mag Lock:	Auto Opener:	Hold Open:	Hinges:	Accessory 1:	Accessory 2:	Accessory 3:	Closer:

Door Remarks:

Security Grille  
 Anti-barricade strategy

**MILLWORK AND SPECIALTY CASEWORK**

Storage Requirements:

**UPPER UNITS** (U1-U8)

**LOWER UNITS** (L1-L12)

**RECEPTION/TRANSACTION COUNTER / CARE TEAM STATION DESK** (TC1, TC2)

**UTILITY SINK AND COUNTER UNIT** (UC1)

**SHELF** (S1)

**FULL-HEIGHT CABINETS** (C1-C5)

**Legend:**

Category	Min. Length (mm)	Motorized Adjustable Height	Standing Height	Specialty Casework
Category 0 - None				
Category 1 - Low (1% - 4%)				
Category 2 - Med (5% - 9%)				
Category 3 - High (10% or Greater)				

**FINISHES**

Full-height Cabinet: \_\_\_\_\_  
 Upper Millwork: \_\_\_\_\_  
 Countertop: \_\_\_\_\_  
 Lower Millwork: \_\_\_\_\_  
 Shelf: \_\_\_\_\_

Remarks:  
 Refer to Appendix 1H [Equipment and Furniture] for requirements

**MECHANICAL REQUIREMENTS**

**PLUMBING**

(Quantity)

Hygiene Sink:	Lavatory:	Kitchen Sink:	Seamless Kitchen Sink:	Utility / Process Sink:	Scrub Sink:	Floor Sink:

Plumbing Remarks:

**Other Fixtures:**

- Shower
- Tub
- Ice Maker
- Water Closet
- Instantaneous Hot Water
- Eyewash Station
- Eyewash/Shower Station
- Emergency Shower
- Flush Rim Sink
- Floor Drain
- Water Bottle Refill Station

Other: \_\_\_\_\_

**MED / NON-MED GASES**

(Quantity)

Oxygen:	Medical Air:	Medical Vacuum:	Nitrous Oxide:	CO2:	AGSS:	Nitrogen:	Laboratory Air:	Laboratory Vacuum:	Utility Compressed Air:
									3

Gas Remarks: Provide (1) utility compressed air per device.

**Appendix 1B Minimum Room Requirements**

Room Name:

Program Number(s):	1. D3.04	7.	13.	19.	25.	31.	37.	43.
	2.	8.	14.	20.	26.	32.	38.	44.
	3.	9.	15.	21.	27.	33.	39.	45.
	4.	10.	16.	22.	28.	34.	40.	46.
	5.	11.	17.	23.	29.	35.	41.	47.
	6.	12.	18.	24.	30.	36.	42.	48.

**ARCHITECTURAL REQUIREMENTS**

<b>WALL AND CEILING</b> Wall Material: <input type="text" value="ARGB 1.2m AFF, GB above"/> Finish: <input type="text" value="EWC"/> Ceiling Material: <input type="text" value="GB"/> Finish: <input type="text" value="ECC"/>	<b>WALL PROTECTION</b> Type: <input type="text" value="PVW"/> <input checked="" type="checkbox"/> Corner Guards <input type="checkbox"/> Hand Rails <input type="checkbox"/> Bed Bumper / Locator Height: <input type="text" value="2185 mm"/> <input checked="" type="checkbox"/> Crash Rails <input type="checkbox"/> Chair Rail	<b>GLAZING</b> <input type="checkbox"/> Interior Glazing	<b>FLOORING TYPES</b> Material: <input type="text" value="VSF"/> Base: <input type="text" value="FCB"/>	<b>ROOM ACCESSORIES</b> <input type="checkbox"/> Coat Hooks <input type="checkbox"/> Ceiling Lift <input checked="" type="checkbox"/> Magnetic Whiteboard <input type="checkbox"/> Mirror <input type="checkbox"/> Infant Change Table <input type="checkbox"/> Privacy Curtain
---	--	---	--	---

- LEGEND:**
- WALL AND CEILING LEGEND:**
- AC Architectural Ceiling
  - ACT Acoustic Ceiling Tile
  - ACT-C Cleanroom
  - ARGB Abuse-Resistant Gypsum Board
  - GB Gypsum Board
  - IRGB Impact-Resistant Gypsum Board
  - KLCT Kitchen Lay-in Ceiling Tile
  - MMRGB Moisture and Mould-Resistant Gypsum Board
  - SACT Security Acoustic Ceiling Tile
- WALL FINISHES LEGEND:**
- EWC Epoxy Wall Coating
  - HPC High Performance Coating
  - PT Paint
- CEILING FINISHES LEGEND:**
- ECC Epoxy Ceiling Coating
  - HPC High Performance Coating
  - PF Prefinished
  - PT Paint
- WALL PROTECTION LEGEND:**
- ESRP Extruded Semi-Rigid PVCu Panel
  - FRL Fibre Reinforced Laminate
  - FRP Fibreglass Reinforced Plastic
  - PVW Protective Vinyl Wallcovering
  - RHIS Rigid High Impact Sheet
  - WSSP Wetwall Solid Surface Panel
  - WVV Wetroom Vinyl Wallcovering
- FLOOR FINISHES LEGEND:**
- CFS Concrete Floor Sealer
  - EFC Epoxy Floor Coating
  - PFC Polyurethane Floor Coating
  - RAF Rubber Athletic Flooring
  - RSF Rubber Sheet Flooring
  - SCF Seamless Cushioned Flooring
  - SDRF Static-Dissipative Rubber Sheet Flooring
  - SDVF Static-Dissipative Vinyl Sheet Flooring
  - VSF Vinyl Sheet Flooring
  - WSVF Wetroom Safety Vinyl Sheet Flooring
- FLOOR BASE LEGEND:**
- FCB Flash Cove Base
  - RB Rubber Base
  - SCF Seamless Cushioned Flooring

**DOORS**

Types:

Type	Qty	Size (mm)	Material	Finish	Side Lt.	Blinds	Protect.	Privacy Film	Function	Card Reader	Mag Lock	Auto Opener	Hold Open	Hinges	Accessory 1	Accessory 2	Accessory 3	Closer
C	2	1065 x 2135	Solid Core	FRL	<input type="checkbox"/>	<input type="checkbox"/>	2 High	<input type="checkbox"/>	Storeroom	<input checked="" type="checkbox"/>	<input type="checkbox"/>	<input checked="" type="checkbox"/>	<input type="checkbox"/>	Butt Hinge	Elec. Strike			Surface

Door Remarks:  Security Grille  Anti-barricade strategy

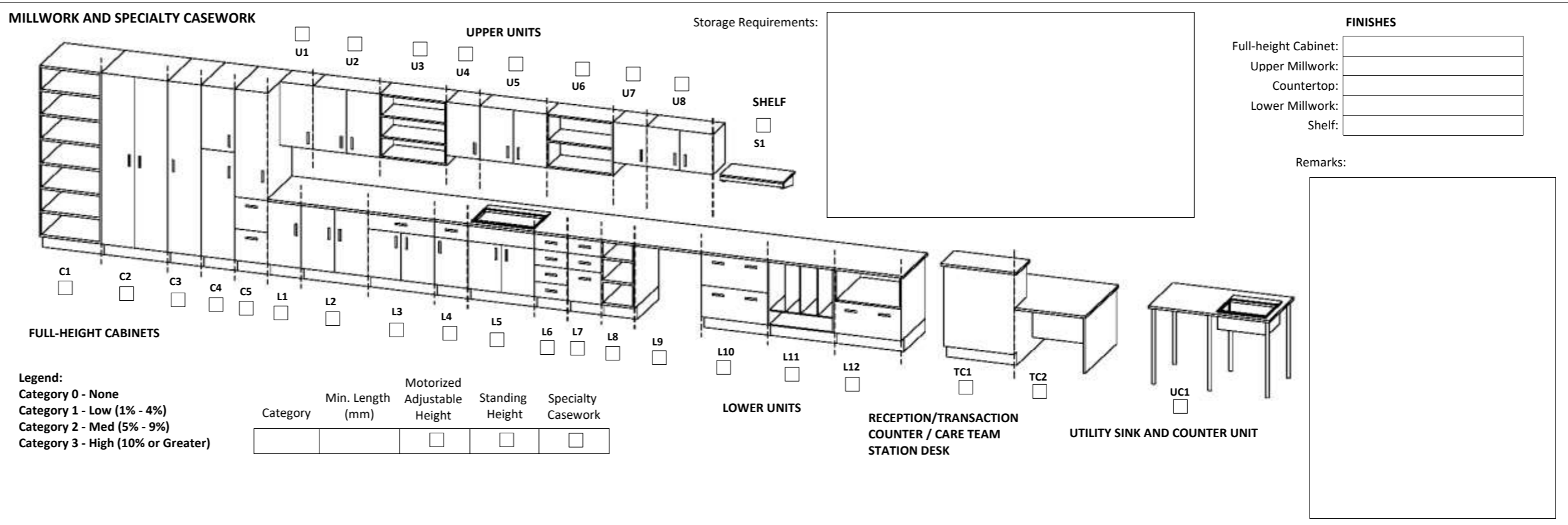

**MECHANICAL REQUIREMENTS**

<b>PLUMBING</b> (Quantity) Hand Hygiene Sink: <input type="text"/> Lavatory: <input type="text"/> Kitchen Sink: <input type="text"/> Seamless Kitchen Sink: <input type="text"/> Utility / Process Sink: <input type="text"/> Scrub Sink: <input type="text"/> Floor Sink: <input type="text"/> Plumbing Remarks: <input type="text"/>	Other Fixtures: <input type="checkbox"/> Shower <input type="checkbox"/> Eyewash Station <input type="checkbox"/> Tub <input type="checkbox"/> Eyewash/Shower Station <input type="checkbox"/> Ice Maker <input type="checkbox"/> Emergency Shower <input type="checkbox"/> Water Closet <input type="checkbox"/> Flush Rim Sink <input type="checkbox"/> Instantaneous Hot Water <input type="checkbox"/> Floor Drain <input type="checkbox"/> <input type="checkbox"/> Water Bottle Refill Station Other: <input type="text"/>	<b>MED / NON-MED GASES</b> (Quantity) Oxygen: <input type="text"/> Medical Air: <input type="text"/> Medical Vacuum: <input type="text"/> Nitrous Oxide: <input type="text"/> CO2: <input type="text"/> AGSS: <input type="text"/> Nitrogen: <input type="text"/> Laboratory Air: <input type="text"/> Laboratory Vacuum: <input type="text"/> Utility Compressed Air: <input type="text"/> Gas Remarks: <input type="text"/>
---	---	---

**Appendix 1B Minimum Room Requirements**

Room Name:

Program Number(s):

1. D2.01	7.	13.	19.	25.	31.	37.	43.
2. D3.01	8.	14.	20.	26.	32.	38.	44.
3.	9.	15.	21.	27.	33.	39.	45.
4.	10.	16.	22.	28.	34.	40.	46.
5.	11.	17.	23.	29.	35.	41.	47.
6.	12.	18.	24.	30.	36.	42.	48.

**ARCHITECTURAL REQUIREMENTS**

<b>WALL AND CEILING</b> Wall Material: <input type="text" value="GB"/> Finish: <input type="text" value="PT"/> Ceiling Material: <input type="text" value="ACT"/> Finish: <input type="text" value="PF"/>	<b>WALL PROTECTION</b> Type: <input type="text" value="FRP"/> <input checked="" type="checkbox"/> Corner Guards <input type="checkbox"/> Hand Rails <input type="checkbox"/> Bed Bumper / Locator Height: <input type="text" value="1600 mm"/> <input type="checkbox"/> Crash Rails <input checked="" type="checkbox"/> Chair Rail	<b>GLAZING</b> <input checked="" type="checkbox"/> Interior Glazing	<b>FLOORING TYPES</b> Material: <input type="text" value="VSF"/> Base: <input type="text" value="FCB"/>	<b>ROOM ACCESSORIES</b> <input type="checkbox"/> Coat Hooks <input type="checkbox"/> Ceiling Lift <input checked="" type="checkbox"/> Magnetic Whiteboard <input type="checkbox"/> Mirror <input type="checkbox"/> Infant Change Table <input type="checkbox"/> Privacy Curtain
---	--	--	--	---

- LEGEND:**
- WALL AND CEILING LEGEND:**
- AC Architectural Ceiling
  - ACT Acoustic Ceiling Tile
  - ACT-C Cleanroom
  - ARGB Abuse-Resistant Gypsum Board
  - GB Gypsum Board
  - IRGB Impact-Resistant Gypsum Board
  - KLCT Kitchen Lay-in Ceiling Tile
  - MMRGB Moisture and Mould-Resistant Gypsum Board
  - SACT Security Acoustic Ceiling Tile
- WALL FINISHES LEGEND:**
- EWC Epoxy Wall Coating
  - HPC High Performance Coating
  - PT Paint
- CEILING FINISHES LEGEND:**
- ECC Epoxy Ceiling Coating
  - HPC High Performance Coating
  - PF Prefinished
  - PT Paint
- WALL PROTECTION LEGEND:**
- ESRP Extruded Semi-Rigid PVCu Panel
  - FRL Fibre Reinforced Laminate
  - FRP Fibreglass Reinforced Plastic
  - PVV Protective Vinyl Wallcovering
  - RHIS Rigid High Impact Sheet
  - WSSP Wetwall Solid Surface Panel
  - WVV Wetroom Vinyl Wallcovering
- FLOOR FINISHES LEGEND:**
- CFS Concrete Floor Sealer
  - EFC Epoxy Floor Coating
  - PFC Polyurethane Floor Coating
  - RAF Rubber Athletic Flooring
  - RSF Rubber Sheet Flooring
  - SCF Seamless Cushioned Flooring
  - SDRF Static-Dissipative Rubber Sheet Flooring
  - SDVF Static-Dissipative Vinyl Sheet Flooring
  - VSF Vinyl Sheet Flooring
  - WSVF Wetroom Safety Vinyl Sheet Flooring
- FLOOR BASE LEGEND:**
- FCB Flash Cove Base
  - RB Rubber Base
  - SCF Seamless Cushioned Flooring

**DOORS**

Types:

Type	Qty	Size (mm)	Material	Finish	Side Lt.	Blinds	Protect.	Film	Function	Card Reader	Mag Lock	Auto Opener	Hold Open	Hinges	Accessory 1	Accessory 2	Accessory 3	Closer
B	1	915 x 2135	Solid Core	FRL	<input type="checkbox"/>	<input type="checkbox"/>	1 Low	<input type="checkbox"/>	Passage	<input type="checkbox"/>	<input type="checkbox"/>	<input type="checkbox"/>	<input type="checkbox"/>	Butt Hinge				Surface

Door Remarks:  Security Grille  Anti-barricade strategy

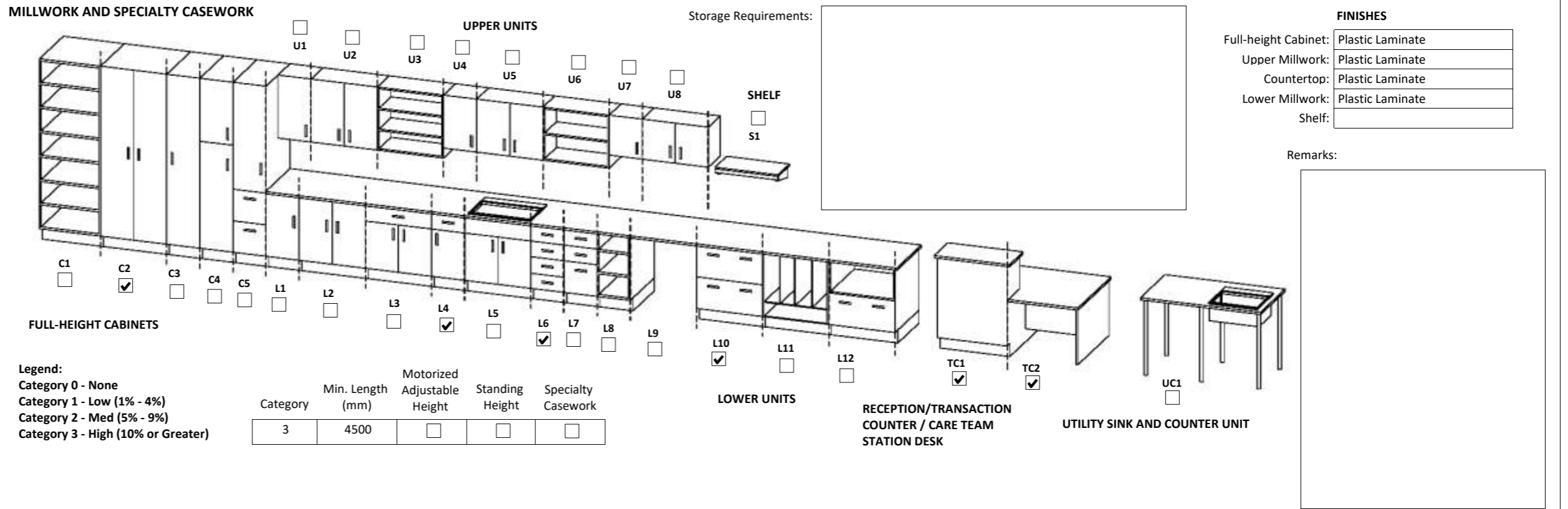

**MECHANICAL REQUIREMENTS**

<b>PLUMBING</b> (Quantity) Hand Hygiene Sink: <input type="text"/> Lavatory: <input type="text"/> Kitchen Sink: <input type="text"/> Seamless Kitchen Sink: <input type="text"/> Utility / Process Sink: <input type="text"/> Scrub Sink: <input type="text"/> Floor Sink: <input type="text"/> Plumbing Remarks: <input type="text"/>	Other Fixtures: <input type="checkbox"/> Shower <input type="checkbox"/> Eyewash Station <input type="checkbox"/> Tub <input type="checkbox"/> Eyewash/Shower Station <input type="checkbox"/> Ice Maker <input type="checkbox"/> Emergency Shower <input type="checkbox"/> Water Closet <input type="checkbox"/> Flush Rim Sink <input type="checkbox"/> Instantaneous Hot Water <input type="checkbox"/> Floor Drain <input type="checkbox"/> <input type="checkbox"/> Water Bottle Refill Station Other: <input type="text"/>	<b>MED / NON-MED GASES</b> (Quantity) Oxygen: <input type="text"/> Medical Air: <input type="text"/> Medical Vacuum: <input type="text"/> Nitrous Oxide: <input type="text"/> CO2: <input type="text"/> AGSS: <input type="text"/> Nitrogen: <input type="text"/> Laboratory Air: <input type="text"/> Laboratory Vacuum: <input type="text"/> Utility Compressed Air: <input type="text"/> Gas Remarks: <input type="text"/>
---	---	---



**Appendix 1B Minimum Room Requirements**

Room Name:

Program Number(s):

1. D2.07	7.	13.	19.	25.	31.	37.	43.
2.	8.	14.	20.	26.	32.	38.	44.
3.	9.	15.	21.	27.	33.	39.	45.
4.	10.	16.	22.	28.	34.	40.	46.
5.	11.	17.	23.	29.	35.	41.	47.
6.	12.	18.	24.	30.	36.	42.	48.

**ARCHITECTURAL REQUIREMENTS**

<b>WALL AND CEILING</b> Wall Material: <input type="text" value="ARGB 1.2m AFF, GB above"/> Finish: <input type="text" value="PT"/> Ceiling Material: <input type="text" value="ACT"/> Finish: <input type="text" value="PF"/>	<b>WALL PROTECTION</b> Type: <input type="text" value="FRP"/> <input checked="" type="checkbox"/> Corner Guards <input type="checkbox"/> Hand Rails <input type="checkbox"/> Bed Bumper / Locator Height: <input type="text" value="1600 mm"/> <input type="checkbox"/> Crash Rails <input checked="" type="checkbox"/> Chair Rail	<b>GLAZING</b> <input type="checkbox"/> Interior Glazing	<b>FLOORING TYPES</b> Material: <input type="text" value="SDVF"/> Base: <input type="text" value="FCB"/>	<b>ROOM ACCESSORIES</b> <input type="checkbox"/> Coat Hooks <input type="checkbox"/> Ceiling Lift <input checked="" type="checkbox"/> Magnetic Whiteboard <input type="checkbox"/> Mirror <input type="checkbox"/> Infant Change Table <input type="checkbox"/> Privacy Curtain
--	--	---	---	---

- LEGEND:**
- WALL AND CEILING LEGEND:**
- AC Architectural Ceiling
  - ACT Acoustic Ceiling Tile
  - ACT-C Cleanroom
  - ARGB Abuse-Resistant Gypsum Board
  - GB Gypsum Board
  - IRGB Impact-Resistant Gypsum Board
  - KLCT Kitchen Lay-in Ceiling Tile
  - MMRGB Moisture and Mould-Resistant Gypsum Board
  - SACT Security Acoustic Ceiling Tile
- WALL FINISHES LEGEND:**
- EWC Epoxy Wall Coating
  - HPC High Performance Coating
  - PT Paint
- CEILING FINISHES LEGEND:**
- ECC Epoxy Ceiling Coating
  - HPC High Performance Coating
  - PF Prefinished
  - PT Paint
- WALL PROTECTION LEGEND:**
- ESRP Extruded Semi-Rigid PVCu Panel
  - FRL Fibre Reinforced Laminate
  - FRP Fibreglass Reinforced Plastic
  - PVV Protective Vinyl Wallcovering
  - RHIS Rigid High Impact Sheet
  - WSSP Wetwall Solid Surface Panel
  - WVV Wetroom Vinyl Wallcovering
- FLOOR FINISHES LEGEND:**
- CFS Concrete Floor Sealer
  - EFC Epoxy Floor Coating
  - PFC Polyurethane Floor Coating
  - RAF Rubber Athletic Flooring
  - RSF Rubber Sheet Flooring
  - SCF Seamless Cushioned Flooring
  - SDRF Static-Dissipative Rubber Sheet Flooring
  - SDVF Static-Dissipative Vinyl Sheet Flooring
  - VSF Vinyl Sheet Flooring
  - WSVF Wetroom Safety Vinyl Sheet Flooring
- FLOOR BASE LEGEND:**
- FCB Flash Cove Base
  - RB Rubber Base
  - SCF Seamless Cushioned Flooring

**DOORS**

Types:

Type	Qty	Size (mm)	Material	Finish	Side Lt.	Blinds	Protect.	Privacy Film	Function	Card Reader	Mag Lock	Auto Opener	Hold Open	Hinges	Accessory 1	Accessory 2	Accessory 3	Closer
C	2	1065 x 2135	Solid Core	FRL	<input type="checkbox"/>	<input type="checkbox"/>	1 Low	<input type="checkbox"/>	Storeroom	<input checked="" type="checkbox"/>	<input type="checkbox"/>	<input type="checkbox"/>	<input type="checkbox"/>	Butt Hinge				Surface

Door Remarks:  Security Grille  Anti-barricade strategy

**MILLWORK AND SPECIALTY CASEWORK**

Storage Requirements:

**UPPER UNITS** (U1-U8) **SHELF** (S1)

**LOWER UNITS** (L1-L12) **RECEPTION/TRANSACTION COUNTER / CARE TEAM STATION DESK** (TC1, TC2) **UTILITY SINK AND COUNTER UNIT** (UC1)

**FULL-HEIGHT CABINETS** (C1-C5)

**Legend:**  
 Category 0 - None  
 Category 1 - Low (1% - 4%)  
 Category 2 - Med (5% - 9%)  
 Category 3 - High (10% or Greater)

Category	Min. Length (mm)	Motorized Adjustable Height	Standing Height	Specialty Casework
1	450	<input type="checkbox"/>	<input type="checkbox"/>	<input type="checkbox"/>

**FINISHES**

Full-height Cabinet:   
 Upper Millwork:   
 Countertop:   
 Lower Millwork:   
 Shelf:

Remarks:

**MECHANICAL REQUIREMENTS**

<b>PLUMBING</b> (Quantity) Hand Hygiene Sink: <input type="text"/> Lavatory: <input type="text"/> Kitchen Sink: <input type="text"/> Seamless Kitchen Sink: <input type="text"/> Utility / Process Sink: <input type="text"/> Scrub Sink: <input type="text"/> Floor Sink: <input type="text"/> Plumbing Remarks: <input type="text"/>	Other Fixtures: <input type="checkbox"/> Shower <input type="checkbox"/> Tub <input type="checkbox"/> Ice Maker <input type="checkbox"/> Water Closet <input type="checkbox"/> Instantaneous Hot Water <input type="checkbox"/> Eyewash Station <input type="checkbox"/> Eyewash/Shower Station <input type="checkbox"/> Emergency Shower <input type="checkbox"/> Flush Rim Sink <input type="checkbox"/> Floor Drain <input type="checkbox"/> Water Bottle Refill Station Other: <input type="text"/>	<b>MED / NON-MED GASES</b> (Quantity) Oxygen: <input type="text"/> Medical Air: <input type="text"/> Medical Vacuum: <input type="text"/> Nitrous Oxide: <input type="text"/> CO2: <input type="text"/> AGSS: <input type="text"/> Nitrogen: <input type="text"/> Laboratory Air: <input type="text"/> Laboratory Vacuum: <input type="text"/> Utility Compressed Air: <input type="text"/> Gas Remarks: <input type="text"/>
---	--	---

**Appendix 1B Minimum Room Requirements**

Room Name:

Program Number(s):

1. D2.16	7.	13.	19.	25.	31.	37.	43.
2.	8.	14.	20.	26.	32.	38.	44.
3.	9.	15.	21.	27.	33.	39.	45.
4.	10.	16.	22.	28.	34.	40.	46.
5.	11.	17.	23.	29.	35.	41.	47.
6.	12.	18.	24.	30.	36.	42.	48.

**ARCHITECTURAL REQUIREMENTS**

<b>WALL AND CEILING</b> Wall Material: <input type="text" value="ARGB 1.2m AFF, GB above"/> Finish: <input type="text" value="PT"/> Ceiling Material: <input type="text" value="ACT"/> Finish: <input type="text" value="PF"/>	<b>WALL PROTECTION</b> Type: <input type="text" value="FRP"/> <input checked="" type="checkbox"/> Corner Guards <input type="checkbox"/> Hand Rails <input type="checkbox"/> Bed Bumper / Locator Height: <input type="text" value="2185 mm"/> <input type="checkbox"/> Crash Rails <input type="checkbox"/> Chair Rail	<b>GLAZING</b> <input type="checkbox"/> Interior Glazing	<b>FLOORING TYPES</b> Material: <input type="text" value="WSVF"/> Base: <input type="text" value="FCB"/>	<b>ROOM ACCESSORIES</b> <input checked="" type="checkbox"/> Coat Hooks <input type="checkbox"/> Ceiling Lift <input checked="" type="checkbox"/> Magnetic Whiteboard <input type="checkbox"/> Mirror <input type="checkbox"/> Infant Change Table <input type="checkbox"/> Privacy Curtain
--	---	---	---	--

- LEGEND:**
- WALL AND CEILING LEGEND:**
- AC Architectural Ceiling
  - ACT Acoustic Ceiling Tile
  - ACT-C Cleanroom
  - ARGB Abuse-Resistant Gypsum Board
  - GB Gypsum Board
  - IRGB Impact-Resistant Gypsum Board
  - KLCT Kitchen Lay-in Ceiling Tile
  - MMRGB Moisture and Mould-Resistant Gypsum Board
  - SACT Security Acoustic Ceiling Tile
- WALL FINISHES LEGEND:**
- EWC Epoxy Wall Coating
  - HPC High Performance Coating
  - PT Paint
- CEILING FINISHES LEGEND:**
- ECC Epoxy Ceiling Coating
  - HPC High Performance Coating
  - PF Prefinished
  - PT Paint
- WALL PROTECTION LEGEND:**
- ESRP Extruded Semi-Rigid PVCu Panel
  - FRL Fibre Reinforced Laminate
  - FRP Fibreglass Reinforced Plastic
  - PVV Protective Vinyl Wallcovering
  - RHIS Rigid High Impact Sheet
  - WSSP Wetwall Solid Surface Panel
  - WVV Wetroom Vinyl Wallcovering
- FLOOR FINISHES LEGEND:**
- CFS Concrete Floor Sealer
  - EFC Epoxy Floor Coating
  - PFC Polyurethane Floor Coating
  - RAF Rubber Athletic Flooring
  - RSF Rubber Sheet Flooring
  - SCF Seamless Cushioned Flooring
  - SDRF Static-Dissipative Rubber Sheet Flooring
  - SDVF Static-Dissipative Vinyl Sheet Flooring
  - VSF Vinyl Sheet Flooring
  - WSVF Wetroom Safety Vinyl Sheet Flooring
- FLOOR BASE LEGEND:**
- FCB Flash Cove Base
  - RB Rubber Base
  - SCF Seamless Cushioned Flooring

**DOORS**

Types:

Type	Qty	Size (mm)	Material	Finish	Side Lt.	Blinds	Protect.	Privacy Film	Function	Card Reader	Mag Lock	Auto Opener	Hold Open	Hinges	Accessory 1	Accessory 2	Accessory 3	Closer
C	1	1220 x 2135	Solid Core	FRL	<input type="checkbox"/>	<input type="checkbox"/>	2 High	<input type="checkbox"/>	Storeroom	<input checked="" type="checkbox"/>	<input type="checkbox"/>	<input type="checkbox"/>	<input type="checkbox"/>	Butt Hinge				Surface
C	1	1220 x 2135	Solid Core	FRL	<input type="checkbox"/>	<input type="checkbox"/>	2 High	<input type="checkbox"/>	Passage	<input type="checkbox"/>	<input type="checkbox"/>	<input type="checkbox"/>	<input type="checkbox"/>	Butt Hinge				Surface

Door Remarks:  Security Grille  Anti-barricade strategy

**MILLWORK AND SPECIALTY CASEWORK**

**UPPER UNITS** (U1-U8) **LOWER UNITS** (L1-L9)

**RECEPTION/TRANSACTION COUNTER / CARE TEAM STATION DESK** (TC1, TC2)

**UTILITY SINK AND COUNTER UNIT** (UC1)

**Storage Requirements:**  SHELF (S1)

**FINISHES**

- Full-height Cabinet:
- Upper Millwork:
- Countertop:
- Lower Millwork:
- Shelf:

Remarks:

**Legend:**

Category	Min. Length (mm)	Motorized Adjustable Height	Standing Height	Specialty Casework
3	2700	<input checked="" type="checkbox"/>	<input checked="" type="checkbox"/>	<input type="checkbox"/>

**MECHANICAL REQUIREMENTS**

**PLUMBING** (Quantity)

Hand Hygiene Sink:	Lavatory:	Kitchen Sink:	Seamless Kitchen Sink:	Utility / Process Sink:	Scrub Sink:	Floor Sink:
1				1		

Plumbing Remarks:

**Other Fixtures:**

- Shower
- Tub
- Ice Maker
- Water Closet
- Instantaneous Hot Water
- Ewewash Station
- Eyewash/Shower Station
- Emergency Shower
- Flush Rim Sink
- Floor Drain
- Water Bottle Refill Station

Other:

**MED / NON-MED GASES** (Quantity)

Oxygen:	Medical Air:	Medical Vacuum:	Nitrous Oxide:	CO2:	AGSS:	Nitrogen:	Laboratory Air:	Laboratory Vacuum:	Utility Compressed Air:

Gas Remarks:

**Appendix 1B Minimum Room Requirements**

Room Name:

Program Number(s):

1. D2.15	7.	13.	19.	25.	31.	37.	43.
2.	8.	14.	20.	26.	32.	38.	44.
3.	9.	15.	21.	27.	33.	39.	45.
4.	10.	16.	22.	28.	34.	40.	46.
5.	11.	17.	23.	29.	35.	41.	47.
6.	12.	18.	24.	30.	36.	42.	48.

**ARCHITECTURAL REQUIREMENTS**

<b>WALL AND CEILING</b> Wall Material: <input type="text" value="ARGB 1.2m AFF, GB above"/> Finish: <input type="text" value="HPC"/> Ceiling Material: <input type="text" value="ACT"/> Finish: <input type="text" value="HPC"/>	<b>WALL PROTECTION</b> Type: <input type="text" value="FRP"/> <input checked="" type="checkbox"/> Corner Guards <input type="checkbox"/> Hand Rails <input type="checkbox"/> Bed Bumper / Locator Height: <input type="text" value="2185 mm"/> <input type="checkbox"/> Crash Rails <input type="checkbox"/> Chair Rail	<b>GLAZING</b> <input type="checkbox"/> Interior Glazing	<b>FLOORING TYPES</b> Material: <input type="text" value="WSVF"/> Base: <input type="text" value="FCB"/>	<b>ROOM ACCESSORIES</b> <input type="checkbox"/> Coat Hooks <input type="checkbox"/> Ceiling Lift <input checked="" type="checkbox"/> Magnetic Whiteboard <input type="checkbox"/> Mirror <input type="checkbox"/> Infant Change Table <input type="checkbox"/> Privacy Curtain
--	---	---	---	---

- LEGEND:**
- WALL AND CEILING LEGEND:**
- AC Architectural Ceiling
  - ACT Acoustic Ceiling Tile
  - ACT-C Cleanroom
  - ARGB Abuse-Resistant Gypsum Board
  - GB Gypsum Board
  - IRGB Impact-Resistant Gypsum Board
  - KLCT Kitchen Lay-in Ceiling Tile
  - MMRGB Moisture and Mould-Resistant Gypsum Board
  - SACT Security Acoustic Ceiling Tile
- WALL FINISHES LEGEND:**
- EWC Epoxy Wall Coating
  - HPC High Performance Coating
  - PT Paint
- CEILING FINISHES LEGEND:**
- ECC Epoxy Ceiling Coating
  - HPC High Performance Coating
  - PF Prefinished
  - PT Paint
- WALL PROTECTION LEGEND:**
- ESRP Extruded Semi-Rigid PVCu Panel
  - FRL Fibre Reinforced Laminate
  - FRP Fibreglass Reinforced Plastic
  - PVV Protective Vinyl Wallcovering
  - RHIS Rigid High Impact Sheet
  - WSSP Wetwall Solid Surface Panel
  - WVV Wetroom Vinyl Wallcovering
- FLOOR FINISHES LEGEND:**
- CFS Concrete Floor Sealer
  - EFC Epoxy Floor Coating
  - PFC Polyurethane Floor Coating
  - RAF Rubber Athletic Flooring
  - RSF Rubber Sheet Flooring
  - SCF Seamless Cushioned Flooring
  - SDRF Static-Dissipative Rubber Sheet Flooring
  - SDVF Static-Dissipative Vinyl Sheet Flooring
  - VSF Vinyl Sheet Flooring
  - WSVF Wetroom Safety Vinyl Sheet Flooring
- FLOOR BASE LEGEND:**
- FCB Flash Cove Base
  - RB Rubber Base
  - SCF Seamless Cushioned Flooring

**DOORS**

Types:

Type	Qty	Size (mm)	Material	Finish	Side Lt.	Blinds	Protect.	Privacy Film	Function	Card Reader	Mag Lock	Auto Opener	Hold Open	Hinges	Accessory 1	Accessory 2	Accessory 3	Closer
C	1	1220 x 2135	Solid Core	FRL	<input type="checkbox"/>	<input type="checkbox"/>	2 High	<input type="checkbox"/>	Storeroom	<input checked="" type="checkbox"/>	<input type="checkbox"/>	<input type="checkbox"/>	<input type="checkbox"/>	Butt Hinge				Surface
C	1	1220 x 2135	Solid Core	FRL	<input type="checkbox"/>	<input type="checkbox"/>	2 High	<input type="checkbox"/>	Passage	<input type="checkbox"/>	<input type="checkbox"/>	<input type="checkbox"/>	<input type="checkbox"/>	Butt Hinge				Surface

Door Remarks:  Security Grille  Anti-barricade strategy

**MILLWORK AND SPECIALTY CASEWORK**

**UPPER UNITS** (U1-U8) **LOWER UNITS** (L1-L9)

**RECEPTION/TRANSACTION COUNTER / CARE TEAM STATION DESK** (TC1, TC2)

**UTILITY SINK AND COUNTER UNIT** (UC1)

**Storage Requirements:**  SHELF (S1)

Category	Min. Length (mm)	Motorized Adjustable Height	Standing Height	Specialty Casework
3	3000	<input type="checkbox"/>	<input type="checkbox"/>	<input type="checkbox"/>

**FINISHES**

Full-height Cabinet:   
 Upper Millwork:   
 Countertop:   
 Lower Millwork:   
 Shelf:

Remarks:

**MECHANICAL REQUIREMENTS**

<b>PLUMBING</b> (Quantity) Hand Hygiene Sink: <input type="text" value="1"/> Lavatory: <input type="text"/> Kitchen Sink: <input type="text"/> Utility / Process Sink: <input type="text" value="1"/> Scrub Sink: <input type="text"/> Floor Sink: <input type="text"/> Plumbing Remarks: <input type="text" value="Locate eyewash/shower station outside of room, in internal corridor"/>	Other Fixtures: <input type="checkbox"/> Shower <input type="checkbox"/> Eyewash Station <input type="checkbox"/> Tub <input type="checkbox"/> Eyewash/Shower Station <input type="checkbox"/> Ice Maker <input type="checkbox"/> Emergency Shower <input type="checkbox"/> Water Closet <input type="checkbox"/> Flush Rim Sink <input type="checkbox"/> Instantaneous Hot Water <input type="checkbox"/> Floor Drain <input type="checkbox"/> <input type="checkbox"/> Water Bottle Refill Station Other: <input type="text"/>	<b>MED / NON-MED GASES</b> (Quantity) Oxygen: <input type="text"/> Medical Air: <input type="text"/> Medical Vacuum: <input type="text"/> Nitrous Oxide: <input type="text"/> CO2: <input type="text"/> AGSS: <input type="text"/> Nitrogen: <input type="text"/> Laboratory Air: <input type="text"/> Laboratory Vacuum: <input type="text"/> Utility Compressed Air: <input type="text"/> Gas Remarks: <input type="text"/>
--	---	---



**Appendix 1B Minimum Room Requirements**

Room Name:

Program Number(s):

1. D2.05	7.	13.	19.	25.	31.	37.	43.
2.	8.	14.	20.	26.	32.	38.	44.
3.	9.	15.	21.	27.	33.	39.	45.
4.	10.	16.	22.	28.	34.	40.	46.
5.	11.	17.	23.	29.	35.	41.	47.
6.	12.	18.	24.	30.	36.	42.	48.

**ARCHITECTURAL REQUIREMENTS**

<b>WALL AND CEILING</b> Wall Material: <input type="text" value="ARGB 1.2m AFF, GB above"/> Finish: <input type="text" value="HPC"/> Ceiling Material: <input type="text" value="GB"/> Finish: <input type="text" value="HPC"/>	<b>WALL PROTECTION</b> Type: <input type="text" value="ESRP"/> <input checked="" type="checkbox"/> Corner Guards <input type="checkbox"/> Hand Rails <input type="checkbox"/> Bed Bumper / Locator Height: <input type="text" value="2185 mm"/> <input type="checkbox"/> Crash Rails <input type="checkbox"/> Chair Rail	<b>GLAZING</b> <input type="checkbox"/> Interior Glazing	<b>FLOORING TYPES</b> Material: <input type="text" value="SDRF"/> Base: <input type="text" value="FCB"/>	<b>ROOM ACCESSORIES</b> <input type="checkbox"/> Coat Hooks <input checked="" type="checkbox"/> Ceiling Lift <input checked="" type="checkbox"/> Magnetic Whiteboard <input type="checkbox"/> Mirror <input type="checkbox"/> Infant Change Table <input type="checkbox"/> Privacy Curtain
---	--	---	---	--

- LEGEND:**
- WALL AND CEILING LEGEND:**
- AC Architectural Ceiling
  - ACT Acoustic Ceiling Tile
  - ACT-C Cleanroom
  - ARGB Abuse-Resistant Gypsum Board
  - GB Gypsum Board
  - IRGB Impact-Resistant Gypsum Board
  - KLCT Kitchen Lay-in Ceiling Tile
  - MMRGB Moisture and Mould-Resistant Gypsum Board
  - SACT Security Acoustic Ceiling Tile
- WALL FINISHES LEGEND:**
- EWC Epoxy Wall Coating
  - HPC High Performance Coating
  - PT Paint
- CEILING FINISHES LEGEND:**
- ECC Epoxy Ceiling Coating
  - HPC High Performance Coating
  - PF Prefinished
  - PT Paint
- WALL PROTECTION LEGEND:**
- ESRP Extruded Semi-Rigid PVCu Panel
  - FRL Fibre Reinforced Laminate
  - FRP Fibreglass Reinforced Plastic
  - PVV Protective Vinyl Wallcovering
  - RHIS Rigid High Impact Sheet
  - WSSP Wetwall Solid Surface Panel
  - WVV Wetroom Vinyl Wallcovering
- FLOOR FINISHES LEGEND:**
- CFS Concrete Floor Sealer
  - EFC Epoxy Floor Coating
  - PFC Polyurethane Floor Coating
  - RAF Rubber Athletic Flooring
  - RSF Rubber Sheet Flooring
  - SCF Seamless Cushioned Flooring
  - SDRF Static-Dissipative Rubber Sheet Flooring
  - SDVF Static-Dissipative Vinyl Sheet Flooring
  - VSF Vinyl Sheet Flooring
  - WSVF Wetroom Safety Vinyl Sheet Flooring
- FLOOR BASE LEGEND:**
- FCB Flash Cove Base
  - RB Rubber Base
  - SCF Seamless Cushioned Flooring

**DOORS**

Types:

Type	Qty	Size (mm)	Material	Finish	Side Lt.	Blinds	Protect.	Privacy Film	Function	Card Reader	Mag Lock	Auto Opener	Hold Open	Hinges	Accessory 1	Accessory 2	Accessory 3	Closer
C	1	1220 x 2135	Shielded	Prefinished	<input type="checkbox"/>	<input type="checkbox"/>		<input type="checkbox"/>	Passage	<input type="checkbox"/>	<input type="checkbox"/>	<input type="checkbox"/>	<input checked="" type="checkbox"/>	Cont. Swing Clear				Concealed
C2	1	1830 x 2135	Shielded	Prefinished	<input type="checkbox"/>	<input type="checkbox"/>	2 High	<input type="checkbox"/>	Push/Pull	<input type="checkbox"/>	<input type="checkbox"/>	<input type="checkbox"/>	<input checked="" type="checkbox"/>	Cont. Swing Clear				Concealed

Door Remarks:  Security Grille  Anti-barricade strategy

Kickplate stainless steel with full door wraparound on jamb and latch side.



**MECHANICAL REQUIREMENTS**

<b>PLUMBING</b> (Quantity) Hand Hygiene Sink: <input type="text"/> Lavatory: <input type="text"/> Kitchen Sink: <input type="text"/> Seamless Kitchen Sink: <input type="text"/> Utility / Process Sink: <input type="text"/> Scrub Sink: <input type="text"/> Floor Sink: <input type="text"/> Plumbing Remarks: <input type="text"/>	Other Fixtures: <input type="checkbox"/> Shower <input type="checkbox"/> Eyewash Station <input type="checkbox"/> Tub <input type="checkbox"/> Eyewash/Shower Station <input type="checkbox"/> Ice Maker <input type="checkbox"/> Emergency Shower <input type="checkbox"/> Water Closet <input type="checkbox"/> Flush Rim Sink <input type="checkbox"/> Instantaneous Hot Water <input type="checkbox"/> Floor Drain <input type="checkbox"/> <input type="checkbox"/> Water Bottle Refill Station Other <input type="text"/>	<b>MED / NON-MED GASES</b> (Quantity) Oxygen: <input type="text" value="4"/> Medical Air: <input type="text" value="4"/> Medical Vacuum: <input type="text" value="4"/> Nitrous Oxide: <input type="text" value="0"/> CO2: <input type="text" value="4"/> AGSS: <input type="text" value="1"/> Nitrogen: <input type="text" value="1"/> Laboratory Air: <input type="text"/> Laboratory Vacuum: <input type="text"/> Utility Compressed Air: <input type="text"/> Gas Remarks: <input type="text" value="Provide (1) set of medical gas on wall, (3) sets for the boom. Carbon dioxide outlet at each set."/>
---	--	---

**Appendix 1B Minimum Room Requirements**

Room Name:

Program Number(s):

1. D2.06	7.	13.	19.	25.	31.	37.	43.
2.	8.	14.	20.	26.	32.	38.	44.
3.	9.	15.	21.	27.	33.	39.	45.
4.	10.	16.	22.	28.	34.	40.	46.
5.	11.	17.	23.	29.	35.	41.	47.
6.	12.	18.	24.	30.	36.	42.	48.

**ARCHITECTURAL REQUIREMENTS**

<b>WALL AND CEILING</b> Wall Material: <input type="text" value="ARGB 1.2m AFF, GB above"/> Finish: <input type="text" value="HPC"/> Ceiling Material: <input type="text" value="GB"/> Finish: <input type="text" value="HPC"/>	<b>WALL PROTECTION</b> Type: <input type="text" value="ESRP"/> <input checked="" type="checkbox"/> Corner Guards <input type="checkbox"/> Hand Rails <input type="checkbox"/> Bed Bumper / Locator Height: <input type="text" value="2185 mm"/> <input type="checkbox"/> Crash Rails <input type="checkbox"/> Chair Rail	<b>GLAZING</b> <input type="checkbox"/> Interior Glazing	<b>FLOORING TYPES</b> Material: <input type="text" value="SDRF"/> Base: <input type="text" value="FCB"/>	<b>ROOM ACCESSORIES</b> <input type="checkbox"/> Coat Hooks <input checked="" type="checkbox"/> Ceiling Lift <input checked="" type="checkbox"/> Magnetic Whiteboard <input type="checkbox"/> Mirror <input type="checkbox"/> Infant Change Table <input type="checkbox"/> Privacy Curtain
---	--	---	---	--

- LEGEND:**
- WALL AND CEILING LEGEND:**
- AC Architectural Ceiling
  - ACT Acoustic Ceiling Tile
  - ACT-C Cleanroom
  - ARGB Abuse-Resistant Gypsum Board
  - GB Gypsum Board
  - IRGB Impact-Resistant Gypsum Board
  - KLCT Kitchen Lay-in Ceiling Tile
  - MMRGB Moisture and Mould-Resistant Gypsum Board
  - SACT Security Acoustic Ceiling Tile
- WALL FINISHES LEGEND:**
- EWC Epoxy Wall Coating
  - HPC High Performance Coating
  - PT Paint
- CEILING FINISHES LEGEND:**
- ECC Epoxy Ceiling Coating
  - HPC High Performance Coating
  - PF Prefinished
  - PT Paint
- WALL PROTECTION LEGEND:**
- ESRP Extruded Semi-Rigid PVCu Panel
  - FRL Fibre Reinforced Laminate
  - FRP Fibreglass Reinforced Plastic
  - PVW Protective Vinyl Wallcovering
  - RHIS Rigid High Impact Sheet
  - WSSP Wetwall Solid Surface Panel
  - WVV Wetroom Vinyl Wallcovering
- FLOOR FINISHES LEGEND:**
- CFS Concrete Floor Sealer
  - EFC Epoxy Floor Coating
  - PFC Polyurethane Floor Coating
  - RAF Rubber Athletic Flooring
  - RSF Rubber Sheet Flooring
  - SCF Seamless Cushioned Flooring
  - SDRF Static-Dissipative Rubber Sheet Flooring
  - SDVF Static-Dissipative Vinyl Sheet Flooring
  - VSF Vinyl Sheet Flooring
  - WSVF Wetroom Safety Vinyl Sheet Flooring
- FLOOR BASE LEGEND:**
- FCB Flash Cove Base
  - RB Rubber Base
  - SCF Seamless Cushioned Flooring

**DOORS**

Types:

Type	Qty	Size (mm)	Material	Finish	Side Lt.	Blinds	Protect.	Privacy Film	Function	Card Reader	Mag Lock	Auto Opener	Hold Open	Hinges	Accessory 1	Accessory 2	Accessory 3	Closer
A	1	1220 x 2135	Shielded	Prefinished	<input type="checkbox"/>	<input type="checkbox"/>		<input type="checkbox"/>	Storeroom	<input checked="" type="checkbox"/>	<input type="checkbox"/>	<input type="checkbox"/>	<input checked="" type="checkbox"/>	Cont. Swing Clear				Concealed
A2	1	1830 x 2135	Shielded	Prefinished	<input type="checkbox"/>	<input type="checkbox"/>	2 High	<input type="checkbox"/>	Push/Pull	<input type="checkbox"/>	<input checked="" type="checkbox"/>	<input type="checkbox"/>	<input checked="" type="checkbox"/>	Cont. Swing Clear				Concealed

**Door Remarks:**  
 Kickplate stainless steel with full door wrap-around on jamb and latch side. Provide type A 1220x2135 for storage closet for HDR unit. Door hardware as required by the Authority. Type A2 door will include a door switch interlocked with the HDR machine to stop the machine if someone opens the door during a procedure.

Security Grille  
 Anti-barricade strategy



**MECHANICAL REQUIREMENTS**

<b>PLUMBING</b> (Quantity) Hand Hygiene Sink: <input type="text"/> Lavatory: <input type="text"/> Kitchen Sink: <input type="text"/> Seamless Kitchen Sink: <input type="text"/> Utility / Process Sink: <input type="text"/> Scrub Sink: <input type="text"/> Floor Sink: <input type="text"/> Plumbing Remarks: <input type="text"/>	Other Fixtures: <input type="checkbox"/> Shower <input type="checkbox"/> Tub <input type="checkbox"/> Ice Maker <input type="checkbox"/> Water Closet <input type="checkbox"/> Instantaneous Hot Water <input type="checkbox"/> Ewwash Station <input type="checkbox"/> Ewwash/Shower Station <input type="checkbox"/> Emergency Shower <input type="checkbox"/> Flush Rim Sink <input type="checkbox"/> Floor Drain <input type="checkbox"/> Water Bottle Refill Station Other: <input type="text"/>	<b>MED / NON-MED GASES</b> (Quantity) Oxygen: <input type="text" value="4"/> Medical Air: <input type="text" value="4"/> Medical Vacuum: <input type="text" value="4"/> Nitrous Oxide: <input type="text" value="0"/> CO2: <input type="text" value="4"/> AGSS: <input type="text" value="1"/> Nitrogen: <input type="text" value="1"/> Laboratory Air: <input type="text"/> Laboratory Vacuum: <input type="text"/> Utility Compressed Air: <input type="text"/> Gas Remarks: <input type="text" value="Provide (1) set of medical gas on wall, (3) sets for the boom. Carbon dioxide outlet at each set."/>
---	---	---

# Appendix 1B Minimum Room Requirements

Room Name:

Program Number(s):

1. D2.04	7.	13.	19.	25.	31.	37.	43.
2.	8.	14.	20.	26.	32.	38.	44.
3.	9.	15.	21.	27.	33.	39.	45.
4.	10.	16.	22.	28.	34.	40.	46.
5.	11.	17.	23.	29.	35.	41.	47.
6.	12.	18.	24.	30.	36.	42.	48.

## ARCHITECTURAL REQUIREMENTS

<b>WALL AND CEILING</b> Wall Material: <input type="text" value="ARGB 1.2m AFF, GB above"/> Finish: <input type="text" value="HPC"/> Ceiling Material: <input type="text" value="GB"/> Finish: <input type="text" value="HPC"/>	<b>WALL PROTECTION</b> Type: <input type="text" value="ESRP"/> <input checked="" type="checkbox"/> Corner Guards <input type="checkbox"/> Hand Rails <input type="checkbox"/> Bed Bumper / Locator Height: <input type="text" value="2185 mm"/> <input type="checkbox"/> Crash Rails <input type="checkbox"/> Chair Rail	<b>GLAZING</b> <input type="checkbox"/> Interior Glazing	<b>FLOORING TYPES</b> Material: <input type="text" value="SDRF"/> Base: <input type="text" value="FCB"/>	<b>ROOM ACCESSORIES</b> <input type="checkbox"/> Coat Hooks <input checked="" type="checkbox"/> Ceiling Lift <input checked="" type="checkbox"/> Magnetic Whiteboard <input type="checkbox"/> Mirror <input type="checkbox"/> Infant Change Table <input type="checkbox"/> Privacy Curtain
---	--	---	---	--

- LEGEND:**
- WALL AND CEILING LEGEND:**
- AC Architectural Ceiling
  - ACT Acoustic Ceiling Tile
  - ACT-C Cleanroom
  - ARGB Abuse-Resistant Gypsum Board
  - GB Gypsum Board
  - IRGB Impact-Resistant Gypsum Board
  - KLCT Kitchen Lay-in Ceiling Tile
  - MMRGB Moisture and Mould-Resistant Gypsum Board
  - SACT Security Acoustic Ceiling Tile
- WALL FINISHES LEGEND:**
- EWC Epoxy Wall Coating
  - HPC High Performance Coating
  - PT Paint
- CEILING FINISHES LEGEND:**
- ECC Epoxy Ceiling Coating
  - HPC High Performance Coating
  - PF Prefinished
  - PT Paint
- WALL PROTECTION LEGEND:**
- ESRP Extruded Semi-Rigid PVCu Panel
  - FRL Fibre Reinforced Laminate
  - FRP Fibreglass Reinforced Plastic
  - PVV Protective Vinyl Wallcovering
  - RHIS Rigid High Impact Sheet
  - WSSP Wetwall Solid Surface Panel
  - WVV Wetroom Vinyl Wallcovering
- FLOOR FINISHES LEGEND:**
- CFS Concrete Floor Sealer
  - EFC Epoxy Floor Coating
  - PFC Polyurethane Floor Coating
  - RAF Rubber Athletic Flooring
  - RSF Rubber Sheet Flooring
  - SCF Seamless Cushioned Flooring
  - SDRF Static-Dissipative Rubber Sheet Flooring
  - SDVF Static-Dissipative Vinyl Sheet Flooring
  - VSF Vinyl Sheet Flooring
  - WSVF Wetroom Safety Vinyl Sheet Flooring
- FLOOR BASE LEGEND:**
- FCB Flash Cove Base
  - RB Rubber Base
  - SCF Seamless Cushioned Flooring

**DOORS**

Types:

Type	Qty	Size (mm)	Material	Finish	Side Lt.	Blinds	Protect.	Privacy Film	Function	Card Reader	Mag Lock	Auto Opener	Hold Open	Hinges	Accessory 1	Accessory 2	Accessory 3	Closer	

Door Remarks:  Security Grille  Anti-barricade strategy

**MILLWORK AND SPECIALTY CASEWORK**

**UPPER UNITS** (U1-U8) **LOWER UNITS** (L1-L12) **RECEPTION/TRANSACTION COUNTER / CARE TEAM STATION DESK** (TC1-TC2) **UTILITY SINK AND COUNTER UNIT** (UC1)

Storage Requirements:

**FINISHES**

Full-height Cabinet:   
 Upper Millwork:   
 Countertop:   
 Lower Millwork:   
 Shelf:

Remarks:

**Legend:**

Category	Min. Length (mm)	Motorized Adjustable Height	Standing Height	Specialty Casework
Category 0 - None				
Category 1 - Low (1% - 4%)				
Category 2 - Med (5% - 9%)				
Category 3 - High (10% or Greater)				

## MECHANICAL REQUIREMENTS

**PLUMBING** (Quantity)

Hand Hygiene Sink:	Lavatory:	Kitchen Sink:	Seamless Kitchen Sink:	Utility / Process Sink:	Scrub Sink:	Floor Sink:
<input type="text"/>	<input type="text"/>	<input type="text"/>	<input type="text"/>	<input type="text"/>	<input type="text"/>	<input type="text"/>

Plumbing Remarks:

**Other Fixtures:**

- Shower
- Tub
- Ice Maker
- Water Closet
- Instantaneous Hot Water
- Eyewash Station
- Eyewash/Shower Station
- Emergency Shower
- Flush Rim Sink
- Floor Drain
- Water Bottle Refill Station

Other:

**MED / NON-MED GASES** (Quantity)

Oxygen:	Medical Air:	Medical Vacuum:	Nitrous Oxide:	CO2:	AGSS:	Nitrogen:	Laboratory Air:	Laboratory Vacuum:	Utility Compressed Air:
<input type="text" value="4"/>	<input type="text" value="4"/>	<input type="text" value="4"/>	<input type="text" value="0"/>	<input type="text" value="4"/>	<input type="text" value="1"/>	<input type="text" value="1"/>	<input type="text"/>	<input type="text"/>	<input type="text"/>

Gas Remarks:



**Appendix 1B Minimum Room Requirements**

Room Name:

Program Number(s):

1. D3.02	7.	13.	19.	25.	31.	37.	43.
2.	8.	14.	20.	26.	32.	38.	44.
3.	9.	15.	21.	27.	33.	39.	45.
4.	10.	16.	22.	28.	34.	40.	46.
5.	11.	17.	23.	29.	35.	41.	47.
6.	12.	18.	24.	30.	36.	42.	48.

**ARCHITECTURAL REQUIREMENTS**

<b>WALL AND CEILING</b> Wall Material: <input type="text" value="ARGB 1.2m AFF, GB above"/> Finish: <input type="text" value="PT"/> Ceiling Material: <input type="text" value="GB"/> Finish: <input type="text" value="ECC"/>		<b>WALL PROTECTION</b> Type: <input type="text" value="ESRP"/> <input checked="" type="checkbox"/> Corner Guards <input type="checkbox"/> Hand Rails <input type="checkbox"/> Bed Bumper / Locator Height: <input type="text" value="2185 mm"/> <input type="checkbox"/> Crash Rails <input type="checkbox"/> Chair Rail		<b>GLAZING</b> <input type="checkbox"/> Interior Glazing		<b>FLOORING TYPES</b> Material: <input type="text" value="SDRF"/> Base: <input type="text" value="FCB"/>		<b>ROOM ACCESSORIES</b> <input checked="" type="checkbox"/> Coat Hooks <input checked="" type="checkbox"/> Ceiling Lift <input checked="" type="checkbox"/> Magnetic Whiteboard <input type="checkbox"/> Mirror <input type="checkbox"/> Infant Change Table <input checked="" type="checkbox"/> Privacy Curtain	
--	--	--	--	---	--	---	--	--	--

- LEGEND:**
- WALL AND CEILING LEGEND:**
- AC Architectural Ceiling
  - ACT Acoustic Ceiling Tile
  - ACT-C Cleanroom
  - ARGB Abuse-Resistant Gypsum Board
  - GB Gypsum Board
  - IRGB Impact-Resistant Gypsum Board
  - KLCT Kitchen Lay-in Ceiling Tile
  - MMRGB Moisture and Mould-Resistant Gypsum Board
  - SACT Security Acoustic Ceiling Tile
- WALL FINISHES LEGEND:**
- EWC Epoxy Wall Coating
  - HPC High Performance Coating
  - PT Paint
- CEILING FINISHES LEGEND:**
- ECC Epoxy Ceiling Coating
  - HPC High Performance Coating
  - PF Prefinished
  - PT Paint
- WALL PROTECTION LEGEND:**
- ESRP Extruded Semi-Rigid PVCu Panel
  - FRL Fibre Reinforced Laminat
  - FRP Fibreglass Reinforced Plastic
  - PVV Protective Vinyl Wallcovering
  - RHIS Rigid High Impact Sheet
  - WSSP Wetwall Solid Surface Panel
  - WVV Wetroom Vinyl Wallcovering
- FLOOR FINISHES LEGEND:**
- CFS Concrete Floor Sealer
  - EFC Epoxy Floor Coating
  - PFC Polyurethane Floor Coating
  - RAF Rubber Athletic Flooring
  - RSF Rubber Sheet Flooring
  - SCF Seamless Cushioned Flooring
  - SDRF Static-Dissipative Rubber Sheet Flooring
  - SDVF Static-Dissipative Vinyl Sheet Flooring
  - VSF Vinyl Sheet Flooring
  - WSVF Wetroom Safety Vinyl Sheet Flooring
- FLOOR BASE LEGEND:**
- FCB Flash Cove Base
  - RB Rubber Base
  - SCF Seamless Cushioned Flooring

**DOORS**

Types:

Note: for Type F doors, the door panels will be approximately 465/1065 unless otherwise required by the Authority

Type	Qty	Size (mm)	Material	Finish	Side Lt.	Blinds	Protect.	Privacy Film	Function	Card Reader	Mag Lock	Auto Opener	Hold Open	Hinges	Accessory 1	Accessory 2	Accessory 3	Closer
F	1	1530 x 2135	Solid Core	FRL	<input type="checkbox"/>	<input type="checkbox"/>	2 High	<input type="checkbox"/>	Passage	<input type="checkbox"/>	<input type="checkbox"/>	<input type="checkbox"/>	<input checked="" type="checkbox"/>	Butt Hinge	Astragal	Flush Bolt		Concealed
C	1	1220 x 2135	Solid Core	FRL	<input type="checkbox"/>	<input type="checkbox"/>	2 High	<input type="checkbox"/>	Push/Pull	<input type="checkbox"/>	<input type="checkbox"/>	<input type="checkbox"/>	<input checked="" type="checkbox"/>	Cont. Swing Clear				Concealed

**DOOR REMARKS:**

Security Grille  
 Anti-barricade strategy

**MILLWORK AND SPECIALTY CASEWORK**

Storage Requirements:

**UPPER UNITS:** U1, U2, U3, U4, U5, U6, U7, U8

**LOWER UNITS:** L1, L2, L3, L4, L5, L6, L7, L8, L9, L10, L11, L12

**RECEPTION/TRANSACTION COUNTER / CARE TEAM STATION DESK:** TC1, TC2

**UTILITY SINK AND COUNTER UNIT:** UC1

**SHELF:** S1

**FULL-HEIGHT CABINETS:** C1, C2, C3, C4, C5

**Legend:**

Category	Min. Length (mm)	Motorized Adjustable Height	Standing Height	Specialty Casework
Category 0 - None		<input type="checkbox"/>	<input type="checkbox"/>	<input type="checkbox"/>
Category 1 - Low (1% - 4%)		<input type="checkbox"/>	<input type="checkbox"/>	<input type="checkbox"/>
Category 2 - Med (5% - 9%)		<input type="checkbox"/>	<input type="checkbox"/>	<input type="checkbox"/>
Category 3 - High (10% or Greater)		<input type="checkbox"/>	<input type="checkbox"/>	<input type="checkbox"/>

**FINISHES**

Full-height Cabinet:   
 Upper Millwork:   
 Countertop:   
 Lower Millwork:   
 Shelf:

**REMARKS:**

**MECHANICAL REQUIREMENTS**

<b>PLUMBING</b> (Quantity) Hand Hygiene Sink: <input type="text" value="1"/> Lavatory: <input type="text"/> Kitchen Sink: <input type="text"/> Seamless Kitchen Sink: <input type="text"/> Utility / Process Sink: <input type="text"/> Scrub Sink: <input type="text"/> Floor Sink: <input type="text"/>		Other Fixtures: <input type="checkbox"/> Shower <input type="checkbox"/> Eyewash Station <input type="checkbox"/> Tub <input type="checkbox"/> Eyewash/Shower Station <input type="checkbox"/> Ice Maker <input type="checkbox"/> Emergency Shower <input type="checkbox"/> Water Closet <input type="checkbox"/> Flush Rim Sink <input type="checkbox"/> Instantaneous Hot Water <input type="checkbox"/> Floor Drain <input type="checkbox"/> <input type="checkbox"/> Water Bottle Refill Station Other: <input type="text"/>		<b>MED / NON-MED GASES</b> (Quantity) Oxygen: <input type="text" value="3"/> Medical Air: <input type="text" value="3"/> Medical Vacuum: <input type="text" value="3"/> Nitrous Oxide: <input type="text" value="2"/> CO2: <input type="text"/> AGSS: <input type="text"/> Nitrogen: <input type="text"/> Laboratory Air: <input type="text"/> Laboratory Vacuum: <input type="text"/> Utility Compressed Air: <input type="text"/>	
Plumbing Remarks: <div style="border: 1px solid black; height: 50px; width: 100%;"></div>		Gas Remarks: <div style="border: 1px solid black; padding: 5px;">Provide (1) set of O2/Medical Air/ Medical Vacuum of medical gas on wall, (2) sets of O2/Medical Air/Medical Vacuum for the boom. Provide (1) CO2 to wall, (1) CO2 to boom.</div>			

**Appendix 1B Minimum Room Requirements**

Room Name:

Program Number(s):

1. D3.03	7.	13.	19.	25.	31.	37.	43.
2.	8.	14.	20.	26.	32.	38.	44.
3.	9.	15.	21.	27.	33.	39.	45.
4.	10.	16.	22.	28.	34.	40.	46.
5.	11.	17.	23.	29.	35.	41.	47.
6.	12.	18.	24.	30.	36.	42.	48.

**ARCHITECTURAL REQUIREMENTS**

<b>WALL AND CEILING</b> Wall Material: <input type="text" value="ARGB 1.2m AFF, GB above"/> Finish: <input type="text" value="PT"/> Ceiling Material: <input type="text" value="GB"/> Finish: <input type="text" value="ECC"/>	<b>WALL PROTECTION</b> Type: <input type="text" value="ESRP"/> <input checked="" type="checkbox"/> Corner Guards <input type="checkbox"/> Hand Rails <input type="checkbox"/> Bed Bumper / Locator Height: <input type="text" value="2185 mm"/> <input type="checkbox"/> Crash Rails <input type="checkbox"/> Chair Rail	<b>GLAZING</b> <input type="checkbox"/> Interior Glazing	<b>FLOORING TYPES</b> Material: <input type="text" value="SDRF"/> Base: <input type="text" value="FCB"/>	<b>ROOM ACCESSORIES</b> <input checked="" type="checkbox"/> Coat Hooks <input checked="" type="checkbox"/> Ceiling Lift <input checked="" type="checkbox"/> Magnetic Whiteboard <input type="checkbox"/> Mirror <input type="checkbox"/> Infant Change Table <input checked="" type="checkbox"/> Privacy Curtain
--	--	---	---	--

- LEGEND:**
- WALL AND CEILING LEGEND:**
- AC Architectural Ceiling
  - ACT Acoustic Ceiling Tile
  - ACT-C Cleanroom
  - ARGB Abuse-Resistant Gypsum Board
  - GB Gypsum Board
  - IRGB Impact-Resistant Gypsum Board
  - KLCT Kitchen Lay-in Ceiling Tile
  - MMRGB Moisture and Mould-Resistant Gypsum Board
  - SACT Security Acoustic Ceiling Tile
- WALL FINISHES LEGEND:**
- EWC Epoxy Wall Coating
  - HPC High Performance Coating
  - PT Paint
- CEILING FINISHES LEGEND:**
- ECC Epoxy Ceiling Coating
  - HPC High Performance Coating
  - PF Prefinished
  - PT Paint
- WALL PROTECTION LEGEND:**
- ESRP Extruded Semi-Rigid PVCu Panel
  - FRL Fibre Reinforced Laminat
  - FRP Fibreglass Reinforced Plastic
  - PVV Protective Vinyl Wallcovering
  - RHIS Rigid High Impact Sheet
  - WSSP Wetwall Solid Surface Panel
  - WVV Wetroom Vinyl Wallcovering
- FLOOR FINISHES LEGEND:**
- CFS Concrete Floor Sealer
  - EFC Epoxy Floor Coating
  - PFC Polyurethane Floor Coating
  - RAF Rubber Athletic Flooring
  - RSF Rubber Sheet Flooring
  - SCF Seamless Cushioned Flooring
  - SDRF Static-Dissipative Rubber Sheet Flooring
  - SDVF Static-Dissipative Vinyl Sheet Flooring
  - VSF Vinyl Sheet Flooring
  - WSVF Wetroom Safety Vinyl Sheet Flooring
- FLOOR BASE LEGEND:**
- FCB Flash Cove Base
  - RB Rubber Base
  - SCF Seamless Cushioned Flooring

**DOORS**

Types:

Note: for Type F doors, the door panels will be approximately 465/1065 unless otherwise required by the Authority

Type	Qty	Size (mm)	Material	Finish	Side Lt.	Blinds	Protect.	Privacy Film	Function	Card Reader	Mag Lock	Auto Opener	Hold Open	Hinges	Accessory 1	Accessory 2	Accessory 3	Closer
F	1	1530 x 2135	Solid Core	FRL	<input type="checkbox"/>	<input type="checkbox"/>	2 High	<input type="checkbox"/>	Passage	<input type="checkbox"/>	<input type="checkbox"/>	<input type="checkbox"/>	<input checked="" type="checkbox"/>	Butt Hinge	Astragal	Flush Bolt		Concealed
C	1	1220 x 2135	Solid Core	FRL	<input type="checkbox"/>	<input type="checkbox"/>	2 High	<input type="checkbox"/>	Push/Pull	<input type="checkbox"/>	<input type="checkbox"/>	<input type="checkbox"/>	<input checked="" type="checkbox"/>	Cont. Swing Clear				Concealed

**DOOR REMARKS:**

Security Grille  
 Anti-barricade strategy



**MECHANICAL REQUIREMENTS**

<b>PLUMBING</b> (Quantity) Hand Hygiene Sink: <input type="text" value="1"/> Lavatory: <input type="text"/> Kitchen Sink: <input type="text"/> Seamless Kitchen Sink: <input type="text"/> Utility / Process Sink: <input type="text"/> Scrub Sink: <input type="text"/> Floor Sink: <input type="text"/> Plumbing Remarks: <input type="text"/>	Other Fixtures: <input type="checkbox"/> Shower <input type="checkbox"/> Eyewash Station <input type="checkbox"/> Tub <input type="checkbox"/> Eyewash/Shower Station <input type="checkbox"/> Ice Maker <input type="checkbox"/> Emergency Shower <input type="checkbox"/> Water Closet <input type="checkbox"/> Flush Rim Sink <input type="checkbox"/> Instantaneous Hot Water <input type="checkbox"/> Floor Drain <input type="checkbox"/> <input type="checkbox"/> Water Bottle Refill Station Other: <input type="text"/>	<b>MED / NON-MED GASES</b> (Quantity) Oxygen: <input type="text" value="3"/> Medical Air: <input type="text" value="3"/> Medical Vacuum: <input type="text" value="3"/> Nitrous Oxide: <input type="text" value="2"/> CO2: <input type="text" value="2"/> AGSS: <input type="text"/> Nitrogen: <input type="text"/> Laboratory Air: <input type="text"/> Laboratory Vacuum: <input type="text"/> Utility Compressed Air: <input type="text"/> Gas Remarks: Provide (1) set of O2/Medical Air/ Medical Vacuum of medical gas on wall, (2) sets of O2/Medical Air/Medical Vacuum for the boom. (1) CO2 to wall, (1) CO2 to boom.
---	---	---

# Appendix 1B Minimum Room Requirements

Room Name:

Program Number(s):

1. D4.02.04	7.	13.	19.	25.	31.	37.	43.
2.	8.	14.	20.	26.	32.	38.	44.
3.	9.	15.	21.	27.	33.	39.	45.
4.	10.	16.	22.	28.	34.	40.	46.
5.	11.	17.	23.	29.	35.	41.	47.
6.	12.	18.	24.	30.	36.	42.	48.

## ARCHITECTURAL REQUIREMENTS

<b>WALL AND CEILING</b> Wall Material: <input type="text" value="ARGB 1.2m AFF, GB above"/> Finish: <input type="text" value="EWC"/> Ceiling Material: <input type="text" value="MMRGB"/> Finish: <input type="text" value="ECC"/>	<b>WALL PROTECTION</b> Type: <input type="text" value="ESRP"/> <input checked="" type="checkbox"/> Corner Guards <input type="checkbox"/> Hand Rails <input type="checkbox"/> Bed Bumper / Locator Height: <input type="text" value="2185 mm"/> <input type="checkbox"/> Crash Rails <input type="checkbox"/> Chair Rail	<b>GLAZING</b> <input type="checkbox"/> Interior Glazing	<b>FLOORING TYPES</b> Material: <input type="text" value="VSF"/> Base: <input type="text" value="FCB"/>	<b>ROOM ACCESSORIES</b> <input type="checkbox"/> Coat Hooks <input type="checkbox"/> Ceiling Lift <input checked="" type="checkbox"/> Magnetic Whiteboard <input type="checkbox"/> Mirror <input type="checkbox"/> Infant Change Table <input type="checkbox"/> Privacy Curtain
--	--	---	--	---

- LEGEND:**
- WALL AND CEILING LEGEND:**
- AC Architectural Ceiling
  - ACT Acoustic Ceiling Tile
  - ACT-C Cleanroom
  - ARGB Abuse-Resistant Gypsum Board
  - GB Gypsum Board
  - IRGB Impact-Resistant Gypsum Board
  - KLCT Kitchen Lay-in Ceiling Tile
  - MMRGB Moisture and Mould-Resistant Gypsum Board
  - SACT Security Acoustic Ceiling Tile
- WALL FINISHES LEGEND:**
- EWC Epoxy Wall Coating
  - HPC High Performance Coating
  - PT Paint
- CEILING FINISHES LEGEND:**
- ECC Epoxy Ceiling Coating
  - HPC High Performance Coating
  - PF Prefinished
  - PT Paint
- WALL PROTECTION LEGEND:**
- ESRP Extruded Semi-Rigid PVCu Panel
  - FRL Fibre Reinforced Laminate
  - FRP Fibreglass Reinforced Plastic
  - PVV Protective Vinyl Wallcovering
  - RHIS Rigid High Impact Sheet
  - WSSP Wetwall Solid Surface Panel
  - WVV Wetroom Vinyl Wallcovering
- FLOOR FINISHES LEGEND:**
- CFS Concrete Floor Sealer
  - EFC Epoxy Floor Coating
  - PFC Polyurethane Floor Coating
  - RAF Rubber Athletic Flooring
  - RSF Rubber Sheet Flooring
  - SCF Seamless Cushioned Flooring
  - SDRF Static-Dissipative Rubber Sheet Flooring
  - SDVF Static-Dissipative Vinyl Sheet Flooring
  - VSF Vinyl Sheet Flooring
  - WSVF Wetroom Safety Vinyl Sheet Flooring
- FLOOR BASE LEGEND:**
- FCB Flash Cove Base
  - RB Rubber Base
  - SCF Seamless Cushioned Flooring

**DOORS**

Types:

Type:Qty:	Size (mm):	Material:	Finish:	Side Lt:	Blinds:	Protect.:	Privacy Film:	Function:	Card Reader:	Mag Lock:	Auto Opener:	Hold Open:	Hinges:	Accessory 1:	Accessory 2:	Accessory 3:	Closer:

Door Remarks:

Security Grille  
 Anti-barricade strategy

**MILLWORK AND SPECIALTY CASEWORK**

**UPPER UNITS** (U1-U8) **LOWER UNITS** (L1-L12) **RECEPTION/TRANSACTION COUNTER / CARE TEAM STATION DESK** (TC1-TC2) **UTILITY SINK AND COUNTER UNIT** (UC1)

Storage Requirements:

**FINISHES**

Full-height Cabinet:   
 Upper Millwork:   
 Countertop:   
 Lower Millwork:   
 Shelf:

Remarks:

**Legend:**

Category	Min. Length (mm)	Motorized Adjustable Height	Standing Height	Specialty Casework
Category 0 - None				
Category 1 - Low (1% - 4%)				
Category 2 - Med (5% - 9%)				
Category 3 - High (10% or Greater)				

## MECHANICAL REQUIREMENTS

<b>PLUMBING</b> (Quantity) Hand Hygiene Sink: <input type="text"/> Lavatory: <input type="text"/> Kitchen Sink: <input type="text"/> Seamless Kitchen Sink: <input type="text"/> Utility / Process Sink: <input type="text"/> Scrub Sink: <input type="text"/> Floor Sink: <input type="text"/> Plumbing Remarks: <input type="text"/>	Other Fixtures: <input type="checkbox"/> Shower <input type="checkbox"/> Tub <input type="checkbox"/> Ice Maker <input type="checkbox"/> Water Closet <input type="checkbox"/> Instantaneous Hot Water <input type="checkbox"/> Eyewash Station <input type="checkbox"/> Eyewash/Shower Station <input type="checkbox"/> Emergency Shower <input type="checkbox"/> Flush Rim Sink <input type="checkbox"/> Floor Drain <input type="checkbox"/> Water Bottle Refill Station Other: <input type="text"/>	<b>MED / NON-MED GASES</b> (Quantity) Oxygen: <input type="text"/> Medical Air: <input type="text"/> Medical Vacuum: <input type="text"/> Nitrous Oxide: <input type="text"/> CO2: <input type="text"/> AGSS: <input type="text"/> Nitrogen: <input type="text"/> Laboratory Air: <input type="text"/> Laboratory Vacuum: <input type="text"/> Utility Compressed Air: <input type="text" value="1"/> Gas Remarks: <input type="text"/>
--	--	---



**Appendix 1B Minimum Room Requirements**

Room Name:

Program Number(s):

1. D4.01.06	7.	13.	19.	25.	31.	37.	43.
2.	8.	14.	20.	26.	32.	38.	44.
3.	9.	15.	21.	27.	33.	39.	45.
4.	10.	16.	22.	28.	34.	40.	46.
5.	11.	17.	23.	29.	35.	41.	47.
6.	12.	18.	24.	30.	36.	42.	48.

**ARCHITECTURAL REQUIREMENTS**

<b>WALL AND CEILING</b> Wall Material: <input type="text" value="ARGB 1.2m AFF, GB above"/> Finish: <input type="text" value="EWC"/> Ceiling Material: <input type="text" value="ACT"/> Finish: <input type="text" value="ECC"/>	<b>WALL PROTECTION</b> Type: <input type="text" value="FRP"/> <input checked="" type="checkbox"/> Corner Guards <input type="checkbox"/> Hand Rails <input type="checkbox"/> Bed Bumper / Locator Height: <input type="text" value="2185 mm"/> <input type="checkbox"/> Crash Rails <input type="checkbox"/> Chair Rail	<b>GLAZING</b> <input type="checkbox"/> Interior Glazing	<b>FLOORING TYPES</b> Material: <input type="text" value="VSF"/> Base: <input type="text" value="FCB"/>	<b>ROOM ACCESSORIES</b> <input type="checkbox"/> Coat Hooks <input type="checkbox"/> Ceiling Lift <input checked="" type="checkbox"/> Magnetic Whiteboard <input type="checkbox"/> Mirror <input type="checkbox"/> Infant Change Table <input type="checkbox"/> Privacy Curtain
--	---	---	--	---

- LEGEND:**
- WALL AND CEILING LEGEND:**
- AC Architectural Ceiling
  - ACT Acoustic Ceiling Tile
  - ACT-C Cleanroom
  - ARGB Abuse-Resistant Gypsum Board
  - GB Gypsum Board
  - IRGB Impact-Resistant Gypsum Board
  - KLCT Kitchen Lay-in Ceiling Tile
  - MMRGB Moisture and Mould-Resistant Gypsum Board
  - SACT Security Acoustic Ceiling Tile
- WALL FINISHES LEGEND:**
- EWC Epoxy Wall Coating
  - HPC High Performance Coating
  - PT Paint
- CEILING FINISHES LEGEND:**
- ECC Epoxy Ceiling Coating
  - HPC High Performance Coating
  - PF Prefinished
  - PT Paint
- WALL PROTECTION LEGEND:**
- ESRP Extruded Semi-Rigid PVCu Panel
  - FRL Fibre Reinforced Laminate
  - FRP Fibreglass Reinforced Plastic
  - PVV Protective Vinyl Wallcovering
  - RHIS Rigid High Impact Sheet
  - WSSP Wetwall Solid Surface Panel
  - WVV Wetroom Vinyl Wallcovering
- FLOOR FINISHES LEGEND:**
- CFS Concrete Floor Sealer
  - EFC Epoxy Floor Coating
  - PFC Polyurethane Floor Coating
  - RAF Rubber Athletic Flooring
  - RSF Rubber Sheet Flooring
  - SCF Seamless Cushioned Flooring
  - SDRF Static-Dissipative Rubber Sheet Flooring
  - SDVF Static-Dissipative Vinyl Sheet Flooring
  - VSF Vinyl Sheet Flooring
  - WSVF Wetroom Safety Vinyl Sheet Flooring
- FLOOR BASE LEGEND:**
- FCB Flash Cove Base
  - RB Rubber Base
  - SCF Seamless Cushioned Flooring

**DOORS**

Types:

Type:Qty:	Size (mm):	Material:	Finish:	Side Lt:	Blinds:	Protect.:	Privacy Film:	Function:	Card Reader:	Mag Lock:	Auto Opener:	Hold Open:	Hinges:	Accessory 1:	Accessory 2:	Accessory 3:	Closer:

Door Remarks:  Security Grille  Anti-barricade strategy

**MILLWORK AND SPECIALTY CASEWORK**

Storage Requirements:

**UPPER UNITS** (U1-U8) **SHELF** (S1)

**LOWER UNITS** (L1-L12) **RECEPTION/TRANSACTION COUNTER / CARE TEAM STATION DESK** (TC1-TC2) **UTILITY SINK AND COUNTER UNIT** (UC1)

**FULL-HEIGHT CABINETS** (C1-C5)

**Legend:**

Category	Min. Length (mm)	Motorized Adjustable Height	Standing Height	Specialty Casework
Category 0 - None				
Category 1 - Low (1% - 4%)				
Category 2 - Med (5% - 9%)				
Category 3 - High (10% or Greater)				
3	1800	<input checked="" type="checkbox"/>	<input checked="" type="checkbox"/>	<input type="checkbox"/>

**FINISHES**

Full-height Cabinet:   
 Upper Millwork:   
 Countertop:   
 Lower Millwork:   
 Shelf:

Remarks:

**MECHANICAL REQUIREMENTS**

<b>PLUMBING</b> (Quantity) Hand Hygiene Sink: <input type="text"/> Lavatory: <input type="text"/> Kitchen Sink: <input type="text"/> Seamless Kitchen Sink: <input type="text"/> Utility / Process Sink: <input type="text"/> Scrub Sink: <input type="text"/> Floor Sink: <input type="text"/> Plumbing Remarks: <input type="text"/>	Other Fixtures: <input type="checkbox"/> Shower <input type="checkbox"/> Eyewash Station <input type="checkbox"/> Tub <input type="checkbox"/> Eyewash/Shower Station <input type="checkbox"/> Ice Maker <input type="checkbox"/> Emergency Shower <input type="checkbox"/> Water Closet <input type="checkbox"/> Flush Rim Sink <input type="checkbox"/> Instantaneous Hot Water <input type="checkbox"/> Floor Drain <input type="checkbox"/> <input type="checkbox"/> Water Bottle Refill Station Other <input type="text"/>	<b>MED / NON-MED GASES</b> (Quantity) Oxygen: <input type="text"/> Medical Air: <input type="text"/> Medical Vacuum: <input type="text"/> Nitrous Oxide: <input type="text"/> CO2: <input type="text"/> AGSS: <input type="text"/> Nitrogen: <input type="text"/> Laboratory Air: <input type="text"/> Laboratory Vacuum: <input type="text"/> Utility Compressed Air: <input type="text" value="1"/> Gas Remarks: <input type="text"/>
---	--	--

**Appendix 1B Minimum Room Requirements**

Room Name:

Program Number(s):

1. D4.01.05	7.	13.	19.	25.	31.	37.	43.
2.	8.	14.	20.	26.	32.	38.	44.
3.	9.	15.	21.	27.	33.	39.	45.
4.	10.	16.	22.	28.	34.	40.	46.
5.	11.	17.	23.	29.	35.	41.	47.
6.	12.	18.	24.	30.	36.	42.	48.

**ARCHITECTURAL REQUIREMENTS**

<b>WALL AND CEILING</b> Wall Material: <input type="text" value="ARGB 1.2m AFF, GB above"/> Finish: <input type="text" value="EWC"/> Ceiling Material: <input type="text" value="MMRGB"/> Finish: <input type="text" value="ECC"/>		<b>WALL PROTECTION</b> Type: <input type="text" value="ESRP"/> <input checked="" type="checkbox"/> Corner Guards <input type="checkbox"/> Hand Rails <input type="checkbox"/> Bed Bumper / Locator Height: <input type="text" value="2185 mm"/> <input type="checkbox"/> Crash Rails <input type="checkbox"/> Chair Rail		<b>GLAZING</b> <input type="checkbox"/> Interior Glazing		<b>FLOORING TYPES</b> Material: <input type="text" value="VSF"/> Base: <input type="text" value="FCB"/>		<b>ROOM ACCESSORIES</b> <input type="checkbox"/> Coat Hooks <input type="checkbox"/> Ceiling Lift <input type="checkbox"/> Magnetic Whiteboard <input type="checkbox"/> Mirror <input type="checkbox"/> Infant Change Table <input type="checkbox"/> Privacy Curtain	
--	--	--	--	---	--	--	--	--	--

- LEGEND:**
- WALL AND CEILING LEGEND:**
- AC Architectural Ceiling
  - ACT Acoustic Ceiling Tile
  - ACT-C Cleanroom
  - ARGB Abuse-Resistant Gypsum Board
  - GB Gypsum Board
  - IRGB Impact-Resistant Gypsum Board
  - KLCT Kitchen Lay-in Ceiling Tile
  - MMRGB Moisture and Mould-Resistant Gypsum Board
  - SACT Security Acoustic Ceiling Tile
- WALL FINISHES LEGEND:**
- EWC Epoxy Wall Coating
  - HPC High Performance Coating
  - PT Paint
- CEILING FINISHES LEGEND:**
- ECC Epoxy Ceiling Coating
  - HPC High Performance Coating
  - PF Prefinished
  - PT Paint
- WALL PROTECTION LEGEND:**
- ESRP Extruded Semi-Rigid PVCu Panel
  - FRL Fibre Reinforced Laminate
  - FRP Fibreglass Reinforced Plastic
  - PVV Protective Vinyl Wallcovering
  - RHIS Rigid High Impact Sheet
  - WSSP Wetwall Solid Surface Panel
  - WVV Wetroom Vinyl Wallcovering
- FLOOR FINISHES LEGEND:**
- CFS Concrete Floor Sealer
  - EFC Epoxy Floor Coating
  - PFC Polyurethane Floor Coating
  - RAF Rubber Athletic Flooring
  - RSF Rubber Sheet Flooring
  - SCF Seamless Cushioned Flooring
  - SDRF Static-Dissipative Rubber Sheet Flooring
  - SDVF Static-Dissipative Vinyl Sheet Flooring
  - VSF Vinyl Sheet Flooring
  - WSVF Wetroom Safety Vinyl Sheet Flooring
- FLOOR BASE LEGEND:**
- FCB Flash Cove Base
  - RB Rubber Base
  - SCF Seamless Cushioned Flooring

**DOORS**

Types:

Type:Qty:	Size (mm):	Material:	Finish:	Side Lt:	Blinds:	Protect.:	Privacy Film:	Function:	Card Reader:	Mag Lock:	Auto Opener:	Hold Open:	Hinges:	Accessory 1:	Accessory 2:	Accessory 3:	Closer:

Door Remarks:  Security Grille  Anti-barricade strategy

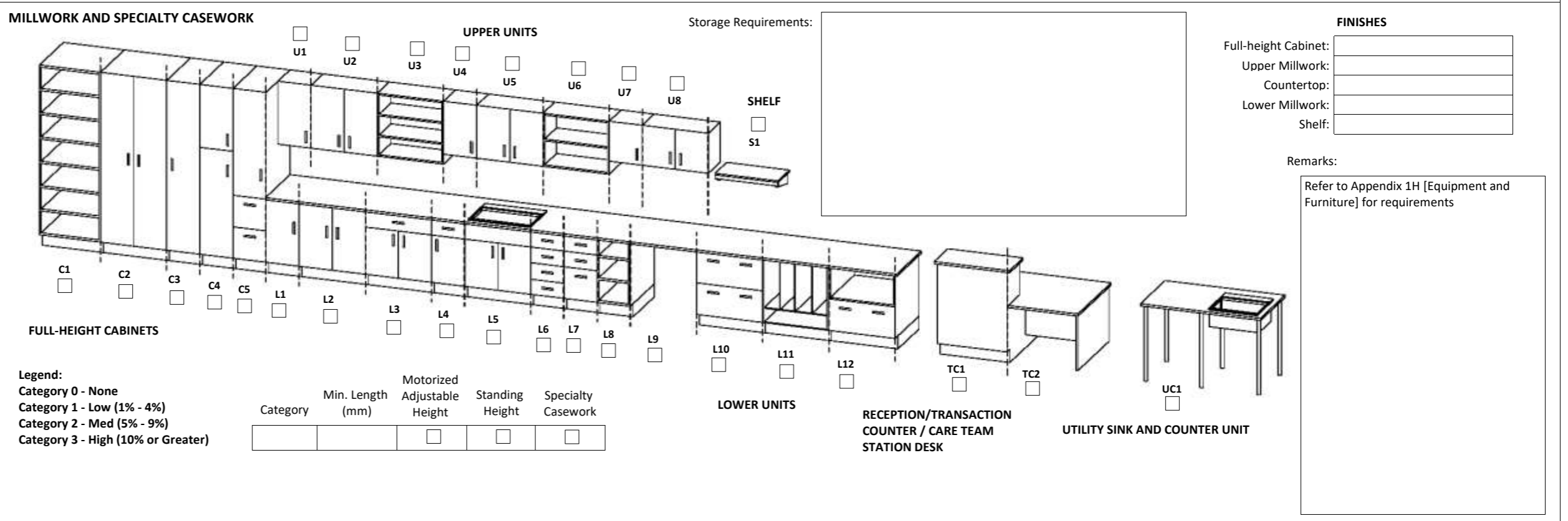

**MECHANICAL REQUIREMENTS**

<b>PLUMBING</b> (Quantity) Hygiene Sink: <input type="text"/> Lavatory: <input type="text"/> Kitchen Sink: <input type="text"/> Kitchen Sink: <input type="text"/> Utility / Process Sink: <input type="text" value="3"/> Scrub Sink: <input type="text"/> Floor Sink: <input type="text"/>		Other Fixtures: <input type="checkbox"/> Shower <input type="checkbox"/> Eyewash Station <input type="checkbox"/> Tub <input type="checkbox"/> Eyewash/Shower Station <input type="checkbox"/> Ice Maker <input type="checkbox"/> Emergency Shower <input type="checkbox"/> Water Closet <input type="checkbox"/> Flush Rim Sink <input type="checkbox"/> Instantaneous Hot Water <input type="checkbox"/> Floor Drain <input type="checkbox"/> <input type="checkbox"/> Water Bottle Refill Station Other <input type="text"/>		<b>MED / NON-MED GASES</b> (Quantity) Oxygen: <input type="text"/> Medical Air: <input type="text" value="3"/> Medical Vacuum: <input type="text"/> Nitrous Oxide: <input type="text"/> CO2: <input type="text"/> AGSS: <input type="text"/> Nitrogen: <input type="text"/> Laboratory Air: <input type="text"/> Laboratory Vacuum: <input type="text" value="3"/> Utility Compressed Air: <input type="text"/>	
Plumbing Remarks: Refer to Appendix 1H [Equipment and Furniture] for reprocessing sink types.		Gas Remarks: Refer to Schedule 1, Section 7.5.11 - Ventilation, for Exhaust Systems Requirements. Provide (1) medical air and (1) vacuum per triple sink bath.			

# Appendix 1B Minimum Room Requirements

Room Name:

Program Number(s):

1. D2.08	7.	13.	19.	25.	31.	37.	43.
2.	8.	14.	20.	26.	32.	38.	44.
3.	9.	15.	21.	27.	33.	39.	45.
4.	10.	16.	22.	28.	34.	40.	46.
5.	11.	17.	23.	29.	35.	41.	47.
6.	12.	18.	24.	30.	36.	42.	48.

## ARCHITECTURAL REQUIREMENTS

<b>WALL AND CEILING</b> Wall Material: <input type="text" value="ARGB 1.2m AFF, GB above"/> Finish: <input type="text" value="PT"/> Ceiling Material: <input type="text" value="ACT"/> Finish: <input type="text" value="PF"/>	<b>WALL PROTECTION</b> Type: <input type="text" value="FRP"/> <input checked="" type="checkbox"/> Corner Guards <input type="checkbox"/> Hand Rails <input type="checkbox"/> Bed Bumper / Locator Height: <input type="text" value="1600 mm"/> <input type="checkbox"/> Crash Rails <input type="checkbox"/> Chair Rail	<b>GLAZING</b> <input type="checkbox"/> Interior Glazing	<b>FLOORING TYPES</b> Material: <input type="text" value="VSF"/> Base: <input type="text" value="FCB"/>	<b>ROOM ACCESSORIES</b> <input type="checkbox"/> Coat Hooks <input type="checkbox"/> Ceiling Lift <input type="checkbox"/> Magnetic Whiteboard <input type="checkbox"/> Mirror <input type="checkbox"/> Infant Change Table <input type="checkbox"/> Privacy Curtain
--	---	---	--	--

- LEGEND:**
- WALL AND CEILING LEGEND:**
- AC Architectural Ceiling
  - ACT Acoustic Ceiling Tile
  - ACT-C Cleanroom
  - ARGB Abuse-Resistant Gypsum Board
  - GB Gypsum Board
  - IRGB Impact-Resistant Gypsum Board
  - KLCT Kitchen Lay-in Ceiling Tile
  - MMRGB Moisture and Mould-Resistant Gypsum Board
  - SACT Security Acoustic Ceiling Tile
- WALL FINISHES LEGEND:**
- EWC Epoxy Wall Coating
  - HPC High Performance Coating
  - PT Paint
- CEILING FINISHES LEGEND:**
- ECC Epoxy Ceiling Coating
  - HPC High Performance Coating
  - PF Prefinished
  - PT Paint
- WALL PROTECTION LEGEND:**
- ESRP Extruded Semi-Rigid PVCu Panel
  - FRL Fibre Reinforced Laminate
  - FRP Fibreglass Reinforced Plastic
  - PVV Protective Vinyl Wallcovering
  - RHIS Rigid High Impact Sheet
  - WSSP Wetwall Solid Surface Panel
  - WVV Wetroom Vinyl Wallcovering
- FLOOR FINISHES LEGEND:**
- CFS Concrete Floor Sealer
  - EFC Epoxy Floor Coating
  - PFC Polyurethane Floor Coating
  - RAF Rubber Athletic Flooring
  - RSF Rubber Sheet Flooring
  - SCF Seamless Cushioned Flooring
  - SDRF Static-Dissipative Rubber Sheet Flooring
  - SDVF Static-Dissipative Vinyl Sheet Flooring
  - VSF Vinyl Sheet Flooring
  - WSVF Wetroom Safety Vinyl Sheet Flooring
- FLOOR BASE LEGEND:**
- FCB Flash Cove Base
  - RB Rubber Base
  - SCF Seamless Cushioned Flooring

**DOORS**

Types:

Type	Qty	Size (mm)	Material	Finish	Side Lt.	Blinds	Protect.	Privacy Film	Function	Card Reader	Mag Lock	Auto Opener	Hold Open	Hinges	Accessory 1	Accessory 2	Accessory 3	Closer
A	1	1065 x 2135	Shielded	Prefinished	<input type="checkbox"/>	<input type="checkbox"/>	2 High	<input type="checkbox"/>	Storeroom	<input checked="" type="checkbox"/>	<input type="checkbox"/>	<input type="checkbox"/>	<input type="checkbox"/>	Butt Hinge				Surface

Door Remarks:

Security Grille  
 Anti-barricade strategy

**MILLWORK AND SPECIALTY CASEWORK**

Storage Requirements:

**UPPER UNITS** (U1-U8)

**LOWER UNITS** (L1-L12)

**RECEPTION/TRANSACTION COUNTER / CARE TEAM STATION DESK** (TC1, TC2)

**UTILITY SINK AND COUNTER UNIT** (UC1)

**SHELF** (S1)

**FULL-HEIGHT CABINETS** (C1-C5)

Category	Min. Length (mm)	Motorized Adjustable Height	Standing Height	Specialty Casework
2	1800	<input type="checkbox"/>	<input type="checkbox"/>	<input type="checkbox"/>

**FINISHES**

Full-height Cabinet:

Upper Millwork:

Countertop:

Lower Millwork:

Shelf:

Remarks:

## MECHANICAL REQUIREMENTS

<b>PLUMBING</b> (Quantity) Hand Hygiene Sink: <input type="text"/> Lavatory: <input type="text"/> Kitchen Sink: <input type="text"/> Seamless Kitchen Sink: <input type="text"/> Utility / Process Sink: <input type="text" value="1"/> Scrub Sink: <input type="text"/> Floor Sink: <input type="text"/> Plumbing Remarks: <input type="text"/>	Other Fixtures: <input type="checkbox"/> Shower <input type="checkbox"/> Tub <input type="checkbox"/> Ice Maker <input type="checkbox"/> Water Closet <input type="checkbox"/> Instantaneous Hot Water <input type="checkbox"/> Eyewash Station <input type="checkbox"/> Eyewash/Shower Station <input type="checkbox"/> Emergency Shower <input type="checkbox"/> Flush Rim Sink <input type="checkbox"/> Floor Drain <input type="checkbox"/> Water Bottle Refill Station Other: <input type="text"/>	<b>MED / NON-MED GASES</b> (Quantity) Oxygen: <input type="text"/> Medical Air: <input type="text"/> Medical Vacuum: <input type="text"/> Nitrous Oxide: <input type="text"/> CO2: <input type="text"/> AGSS: <input type="text"/> Nitrogen: <input type="text"/> Laboratory Air: <input type="text"/> Laboratory Vacuum: <input type="text"/> Utility Compressed Air: <input type="text"/> Gas Remarks: <input type="text"/>
---	---	---



**Appendix 1B Minimum Room Requirements**

Room Name:

Program Number(s):

1. D2.30	7.	13.	19.	25.	31.	37.	43.
2.	8.	14.	20.	26.	32.	38.	44.
3.	9.	15.	21.	27.	33.	39.	45.
4.	10.	16.	22.	28.	34.	40.	46.
5.	11.	17.	23.	29.	35.	41.	47.
6.	12.	18.	24.	30.	36.	42.	48.

**ARCHITECTURAL REQUIREMENTS**

<b>WALL AND CEILING</b> Wall Material: <input type="text" value="ARGB 1.2m AFF, GB above"/> Finish: <input type="text" value="PT"/> Ceiling Material: <input type="text" value="ACT"/> Finish: <input type="text" value="PF"/>		<b>WALL PROTECTION</b> Type: <input type="text" value="RHIS"/> <input checked="" type="checkbox"/> Corner Guards <input type="checkbox"/> Hand Rails <input type="checkbox"/> Bed Bumper / Locator Height: <input type="text" value="1350 mm"/> <input type="checkbox"/> Crash Rails <input checked="" type="checkbox"/> Chair Rail		<b>GLAZING</b> <input type="checkbox"/> Interior Glazing		<b>FLOORING TYPES</b> Material: <input type="text" value="SDVF"/> Base: <input type="text" value="FCB"/>		<b>ROOM ACCESSORIES</b> <input type="checkbox"/> Coat Hooks <input type="checkbox"/> Ceiling Lift <input type="checkbox"/> Magnetic Whiteboard <input type="checkbox"/> Mirror <input type="checkbox"/> Infant Change Table <input type="checkbox"/> Privacy Curtain	
--	--	---	--	---	--	---	--	--	--

- LEGEND:**
- WALL AND CEILING LEGEND:**
- AC Architectural Ceiling
  - ACT Acoustic Ceiling Tile
  - ACT-C Cleanroom
  - ARGB Abuse-Resistant Gypsum Board
  - GB Gypsum Board
  - IRGB Impact-Resistant Gypsum Board
  - KLCT Kitchen Lay-in Ceiling Tile
  - MMRGB Moisture and Mould-Resistant Gypsum Board
  - SACT Security Acoustic Ceiling Tile
- WALL FINISHES LEGEND:**
- EWC Epoxy Wall Coating
  - HPC High Performance Coating
  - PT Paint
- CEILING FINISHES LEGEND:**
- ECC Epoxy Ceiling Coating
  - HPC High Performance Coating
  - PF Prefinished
  - PT Paint
- WALL PROTECTION LEGEND:**
- ESRP Extruded Semi-Rigid PVCu Panel
  - FRL Fibre Reinforced Laminate
  - FRP Fibreglass Reinforced Plastic
  - PVV Protective Vinyl Wallcovering
  - RHIS Rigid High Impact Sheet
  - WSSP Wetwall Solid Surface Panel
  - WVV Wetroom Vinyl Wallcovering
- FLOOR FINISHES LEGEND:**
- CFS Concrete Floor Sealer
  - EFC Epoxy Floor Coating
  - PFC Polyurethane Floor Coating
  - RAF Rubber Athletic Flooring
  - RSF Rubber Sheet Flooring
  - SCF Seamless Cushioned Flooring
  - SDRF Static-Dissipative Rubber Sheet Flooring
  - SDVF Static-Dissipative Vinyl Sheet Flooring
  - VSF Vinyl Sheet Flooring
  - WSVF Wetroom Safety Vinyl Sheet Flooring
- FLOOR BASE LEGEND:**
- FCB Flash Cove Base
  - RB Rubber Base
  - SCF Seamless Cushioned Flooring

**DOORS**

Types:

Type	Qty	Size (mm)	Material	Finish	Side Lt.	Blinds	Protect.	Privacy Film	Function	Card Reader	Mag Lock	Auto Opener	Hold Open	Hinges	Accessory 1	Accessory 2	Accessory 3	Closer
A	1	1220 x 2135	Solid Core	FRL	<input type="checkbox"/>	<input type="checkbox"/>	1 Low	<input type="checkbox"/>	Storeroom	<input checked="" type="checkbox"/>	<input type="checkbox"/>	<input type="checkbox"/>	<input type="checkbox"/>	Butt Hinge				Surface

Door Remarks:  Security Grille  Anti-barricade strategy



**MECHANICAL REQUIREMENTS**

<b>PLUMBING</b> (Quantity) Hand Hygiene Sink: <input type="text"/> Lavatory: <input type="text"/> Kitchen Sink: <input type="text"/> Seamless Kitchen Sink: <input type="text"/> Utility / Process Sink: <input type="text"/> Scrub Sink: <input type="text"/> Floor Sink: <input type="text"/>							Other Fixtures: <input type="checkbox"/> Shower <input type="checkbox"/> Tub <input type="checkbox"/> Ice Maker <input type="checkbox"/> Water Closet <input type="checkbox"/> Instantaneous Hot Water			<input type="checkbox"/> Eyewash Station <input type="checkbox"/> Eyewash/Shower Station <input type="checkbox"/> Emergency Shower <input type="checkbox"/> Flush Rim Sink <input type="checkbox"/> Floor Drain <input type="checkbox"/> Water Bottle Refill Station			<b>MED / NON-MED GASES</b> (Quantity) Oxygen: <input type="text"/> Medical Air: <input type="text"/> Medical Vacuum: <input type="text"/> Nitrous Oxide: <input type="text"/> CO2: <input type="text"/> AGSS: <input type="text"/> Nitrogen: <input type="text"/> Laboratory Air: <input type="text"/> Laboratory Vacuum: <input type="text"/> Utility Compressed Air: <input type="text"/>				
Plumbing Remarks: <input type="text"/>							Gas Remarks: <input type="text"/>										

**Appendix 1B Minimum Room Requirements**

Room Name:

Program Number(s):

1. D5.01	7.	13.	19.	25.	31.	37.	43.
2.	8.	14.	20.	26.	32.	38.	44.
3.	9.	15.	21.	27.	33.	39.	45.
4.	10.	16.	22.	28.	34.	40.	46.
5.	11.	17.	23.	29.	35.	41.	47.
6.	12.	18.	24.	30.	36.	42.	48.

**ARCHITECTURAL REQUIREMENTS**

<b>WALL AND CEILING</b> Wall Material: <input type="text" value="ARGB 1.2m AFF, GB above"/> Finish: <input type="text" value="EWC"/> Ceiling Material: <input type="text" value="ACT"/> Finish: <input type="text" value="ECC"/>	<b>WALL PROTECTION</b> Type: <input type="text" value="FRP"/> <input checked="" type="checkbox"/> Corner Guards <input type="checkbox"/> Hand Rails <input type="checkbox"/> Bed Bumper / Locator Height: <input type="text" value="1600 mm"/> <input checked="" type="checkbox"/> Crash Rails <input type="checkbox"/> Chair Rail	<b>GLAZING</b> <input type="checkbox"/> Interior Glazing	<b>FLOORING TYPES</b> Material: <input type="text" value="WSVF"/> Base: <input type="text" value="FCB"/>	<b>ROOM ACCESSORIES</b> <input type="checkbox"/> Coat Hooks <input type="checkbox"/> Ceiling Lift <input type="checkbox"/> Magnetic Whiteboard <input type="checkbox"/> Mirror <input type="checkbox"/> Infant Change Table <input type="checkbox"/> Privacy Curtain
--	--	---	---	--

- LEGEND:**
- WALL AND CEILING LEGEND:**
- AC Architectural Ceiling
  - ACT Acoustic Ceiling Tile
  - ACT-C Cleanroom
  - ARGB Abuse-Resistant Gypsum Board
  - GB Gypsum Board
  - IRGB Impact-Resistant Gypsum Board
  - KLCT Kitchen Lay-in Ceiling Tile
  - MMRGB Moisture and Mould-Resistant Gypsum Board
  - SACT Security Acoustic Ceiling Tile
- WALL FINISHES LEGEND:**
- EWC Epoxy Wall Coating
  - HPC High Performance Coating
  - PT Paint
- CEILING FINISHES LEGEND:**
- ECC Epoxy Ceiling Coating
  - HPC High Performance Coating
  - PF Prefinished
  - PT Paint
- WALL PROTECTION LEGEND:**
- ESRP Extruded Semi-Rigid PVCu Panel
  - FRL Fibre Reinforced Laminated
  - FRP Fibreglass Reinforced Plastic
  - PVV Protective Vinyl Wallcovering
  - RHIS Rigid High Impact Sheet
  - WSSP Wetwall Solid Surface Panel
  - WVV Wetroom Vinyl Wallcovering
- FLOOR FINISHES LEGEND:**
- CFS Concrete Floor Sealer
  - EFC Epoxy Floor Coating
  - PFC Polyurethane Floor Coating
  - RAF Rubber Athletic Flooring
  - RSF Rubber Sheet Flooring
  - SCF Seamless Cushioned Flooring
  - SDRF Static-Dissipative Rubber Sheet Flooring
  - SDVF Static-Dissipative Vinyl Sheet Flooring
  - VSF Vinyl Sheet Flooring
  - WSVF Wetroom Safety Vinyl Sheet Flooring
- FLOOR BASE LEGEND:**
- FCB Flash Cove Base
  - RB Rubber Base
  - SCF Seamless Cushioned Flooring

**DOORS**

Types:

Type	Qty	Size (mm)	Material	Finish	Side Lt.	Blinds	Protect.	Privacy Film	Function	Card Reader	Mag Lock	Auto Opener	Hold Open	Hinges	Accessory 1	Accessory 2	Accessory 3	Closer
C2	1	1220 x 2135	Solid Core	FRL	<input type="checkbox"/>	<input type="checkbox"/>	2 High	<input type="checkbox"/>	Storeroom	<input checked="" type="checkbox"/>	<input type="checkbox"/>	<input checked="" type="checkbox"/>	<input type="checkbox"/>	Butt Hinge	Astragal	Flush Bolt	Elec. Strike	Surface
C2	1	1220 x 2135	Solid Core	FRL	<input type="checkbox"/>	<input type="checkbox"/>	2 High	<input type="checkbox"/>	Push/Pull	<input type="checkbox"/>	<input type="checkbox"/>	<input checked="" type="checkbox"/>	<input type="checkbox"/>	Butt Hinge	Astragal	Flush Bolt	Elec. Strike	Surface

Door Remarks:  Security Grille  Anti-barricade strategy

Provide card reader to door leading to the exterior of the department

**MILLWORK AND SPECIALTY CASEWORK**

**UPPER UNITS** (U1-U8) **LOWER UNITS** (L1-L12) **RECEPTION/TRANSACTION COUNTER / CARE TEAM STATION DESK** (TC1-TC2) **UTILITY SINK AND COUNTER UNIT** (UC1)

Storage Requirements:

**FINISHES**

Full-height Cabinet:   
 Upper Millwork:   
 Countertop:   
 Lower Millwork:   
 Shelf:

Remarks:

Category	Min. Length (mm)	Motorized Adjustable Height	Standing Height	Specialty Casework
Category 0 - None		<input type="checkbox"/>	<input type="checkbox"/>	<input type="checkbox"/>
Category 1 - Low (1% - 4%)		<input type="checkbox"/>	<input type="checkbox"/>	<input type="checkbox"/>
Category 2 - Med (5% - 9%)		<input type="checkbox"/>	<input type="checkbox"/>	<input type="checkbox"/>
Category 3 - High (10% or Greater)		<input type="checkbox"/>	<input type="checkbox"/>	<input type="checkbox"/>

**MECHANICAL REQUIREMENTS**

<b>PLUMBING</b> (Quantity) Hand Hygiene Sink: <input type="text" value="1"/> Lavatory: <input type="text"/> Kitchen Sink: <input type="text"/> Seamless Kitchen Sink: <input type="text"/> Utility / Process Sink: <input type="text"/> Scrub Sink: <input type="text"/> Floor Sink: <input type="text"/> Plumbing Remarks: <input type="text" value="Provide docking station for the fluid management system"/>	Other Fixtures: <input type="checkbox"/> Shower <input type="checkbox"/> Tub <input type="checkbox"/> Ice Maker <input type="checkbox"/> Water Closet <input type="checkbox"/> Instantaneous Hot Water <input type="checkbox"/> Eyewash Station <input type="checkbox"/> Eyewash/Shower Station <input type="checkbox"/> Emergency Shower <input checked="" type="checkbox"/> Flush Rim Sink <input type="checkbox"/> Floor Drain <input type="checkbox"/> Water Bottle Refill Station Other: <input type="text"/>	<b>MED / NON-MED GASES</b> (Quantity) Oxygen: <input type="text"/> Medical Air: <input type="text"/> Medical Vacuum: <input type="text"/> Nitrous Oxide: <input type="text"/> CO2: <input type="text"/> AGSS: <input type="text"/> Nitrogen: <input type="text"/> Laboratory Air: <input type="text"/> Laboratory Vacuum: <input type="text"/> Utility Compressed Air: <input type="text"/> Gas Remarks: <input type="text"/>
--	---	---

**Appendix 1B Minimum Room Requirements**

Room Name:

Program Number(s):

1.	D2.12	7.		13.		19.		25.		31.		37.		43.
2.		8.		14.		20.		26.		32.		38.		44.
3.		9.		15.		21.		27.		33.		39.		45.
4.		10.		16.		22.		28.		34.		40.		46.
5.		11.		17.		23.		29.		35.		41.		47.
6.		12.		18.		24.		30.		36.		42.		48.

**ARCHITECTURAL REQUIREMENTS**

<b>WALL AND CEILING</b> Wall Material: <input type="text" value="ARGB 1.2m AFF, GB above"/> Finish: <input type="text" value="EWC"/> Ceiling Material: <input type="text" value="ACT-C"/> Finish: <input type="text" value="ECC"/>	<b>WALL PROTECTION</b> Type: <input type="text" value="FRP"/> <input checked="" type="checkbox"/> Corner Guards <input type="checkbox"/> Hand Rails <input type="checkbox"/> Bed Bumper / Locator Height: <input type="text" value="2185 mm"/> <input checked="" type="checkbox"/> Crash Rails <input type="checkbox"/> Chair Rail	<b>GLAZING</b> <input type="checkbox"/> Interior Glazing	<b>FLOORING TYPES</b> Material: <input type="text" value="VSF"/> Base: <input type="text" value="FCB"/>	<b>ROOM ACCESSORIES</b> <input type="checkbox"/> Coat Hooks <input type="checkbox"/> Ceiling Lift <input checked="" type="checkbox"/> Magnetic Whiteboard <input type="checkbox"/> Mirror <input type="checkbox"/> Infant Change Table <input type="checkbox"/> Privacy Curtain
--	--	---	--	---

- LEGEND:**
- WALL AND CEILING LEGEND:**
- AC Architectural Ceiling
  - ACT Acoustic Ceiling Tile
  - ACT-C Cleanroom
  - ARGB Abuse-Resistant Gypsum Board
  - GB Gypsum Board
  - IRGB Impact-Resistant Gypsum Board
  - KLCT Kitchen Lay-in Ceiling Tile
  - MMRGB Moisture and Mould-Resistant Gypsum Board
  - SACT Security Acoustic Ceiling Tile
- WALL FINISHES LEGEND:**
- EWC Epoxy Wall Coating
  - HPC High Performance Coating
  - PT Paint
- CEILING FINISHES LEGEND:**
- ECC Epoxy Ceiling Coating
  - HPC High Performance Coating
  - PF Prefinished
  - PT Paint
- WALL PROTECTION LEGEND:**
- ESRP Extruded Semi-Rigid PVCu Panel
  - FRL Fibre Reinforced Laminate
  - FRP Fibreglass Reinforced Plastic
  - PVV Protective Vinyl Wallcovering
  - RHIS Rigid High Impact Sheet
  - WSSP Wetwall Solid Surface Panel
  - WVV Wetroom Vinyl Wallcovering
- FLOOR FINISHES LEGEND:**
- CFS Concrete Floor Sealer
  - EFC Epoxy Floor Coating
  - PFC Polyurethane Floor Coating
  - RAF Rubber Athletic Flooring
  - RSF Rubber Sheet Flooring
  - SCF Seamless Cushioned Flooring
  - SDRF Static-Dissipative Rubber Sheet Flooring
  - SDVF Static-Dissipative Vinyl Sheet Flooring
  - VSF Vinyl Sheet Flooring
  - WSVF Wetroom Safety Vinyl Sheet Flooring
- FLOOR BASE LEGEND:**
- FCB Flash Cove Base
  - RB Rubber Base
  - SCF Seamless Cushioned Flooring

**DOORS**

Types:

Type	Qty	Size (mm)	Material	Finish	Side Lt.	Blinds	Protect.	Privacy Film	Function	Card Reader	Mag Lock	Auto Opener	Hold Open	Hinges	Accessory 1	Accessory 2	Accessory 3	Closer
C	2	1220 x 2135	Solid Core	FRL	<input type="checkbox"/>	<input type="checkbox"/>	2 High	<input type="checkbox"/>	Passage	<input type="checkbox"/>	<input type="checkbox"/>	<input checked="" type="checkbox"/>	<input checked="" type="checkbox"/>	Butt Hinge	Elec. Strike			Surface

Door Remarks:  Security Grille  Anti-barricade strategy

**MILLWORK AND SPECIALTY CASEWORK**

**UPPER UNITS** (U1-U8) **LOWER UNITS** (L1-L9) **SHELF** (S1) **RECEPTION/TRANSACTION COUNTER / CARE TEAM STATION DESK** (TC1, TC2) **UTILITY SINK AND COUNTER UNIT** (UC1)

Storage Requirements:

**FINISHES**

Full-height Cabinet:   
 Upper Millwork:   
 Countertop:   
 Lower Millwork:   
 Shelf:

Remarks:

Category	Min. Length (mm)	Motorized Adjustable Height	Standing Height	Specialty Casework
1	1500	<input checked="" type="checkbox"/>	<input type="checkbox"/>	<input type="checkbox"/>

**MECHANICAL REQUIREMENTS**

<b>PLUMBING</b> (Quantity) Hand Hygiene Sink: <input type="text"/> Lavatory: <input type="text"/> Kitchen Sink: <input type="text"/> Seamless Kitchen Sink: <input type="text"/> Utility / Process Sink: <input type="text"/> Scrub Sink: <input type="text"/> Floor Sink: <input type="text"/> Plumbing Remarks: <input type="text"/>	Other Fixtures: <input type="checkbox"/> Shower <input type="checkbox"/> Tub <input type="checkbox"/> Ice Maker <input type="checkbox"/> Water Closet <input type="checkbox"/> Instantaneous Hot Water <input type="checkbox"/> Eyewash Station <input type="checkbox"/> Eyewash/Shower Station <input type="checkbox"/> Emergency Shower <input type="checkbox"/> Flush Rim Sink <input type="checkbox"/> Floor Drain <input type="checkbox"/> Water Bottle Refill Station Other: <input type="text"/>	<b>MED / NON-MED GASES</b> (Quantity) Oxygen: <input type="text"/> Medical Air: <input type="text"/> Medical Vacuum: <input type="text"/> Nitrous Oxide: <input type="text"/> CO2: <input type="text"/> AGSS: <input type="text"/> Nitrogen: <input type="text"/> Laboratory Air: <input type="text"/> Laboratory Vacuum: <input type="text"/> Utility Compressed Air: <input type="text"/> Gas Remarks: <input type="text"/>
---	--	---



**Appendix 1B Minimum Room Requirements**

Room Name:

Program Number(s):	1. D2.20	7.	13.	19.	25.	31.	37.	43.
	2.	8.	14.	20.	26.	32.	38.	44.
	3.	9.	15.	21.	27.	33.	39.	45.
	4.	10.	16.	22.	28.	34.	40.	46.
	5.	11.	17.	23.	29.	35.	41.	47.
	6.	12.	18.	24.	30.	36.	42.	48.

**ARCHITECTURAL REQUIREMENTS**

<b>WALL AND CEILING</b> Wall Material: <input type="text" value="ARGB 1.2m AFF, GB above"/> Finish: <input type="text" value="PT"/> Ceiling Material: <input type="text" value="ACT"/> Finish: <input type="text" value="PF"/>		<b>WALL PROTECTION</b> Type: <input type="text" value="FRP"/> <input checked="" type="checkbox"/> Corner Guards <input type="checkbox"/> Hand Rails <input type="checkbox"/> Bed Bumper / Locator Height: <input type="text" value="1350 mm"/> <input type="checkbox"/> Crash Rails <input type="checkbox"/> Chair Rail		<b>GLAZING</b> <input type="checkbox"/> Interior Glazing		<b>FLOORING TYPES</b> Material: <input type="text" value="VSF"/> Base: <input type="text" value="FCB"/>		<b>ROOM ACCESSORIES</b> <input type="checkbox"/> Coat Hooks <input type="checkbox"/> Ceiling Lift <input type="checkbox"/> Magnetic Whiteboard <input type="checkbox"/> Mirror <input type="checkbox"/> Infant Change Table <input type="checkbox"/> Privacy Curtain	
--	--	---	--	---	--	--	--	--	--

- LEGEND:**
- WALL AND CEILING LEGEND:**
- AC Architectural Ceiling
  - ACT Acoustic Ceiling Tile
  - ACT-C Cleanroom
  - ARGB Abuse-Resistant Gypsum Board
  - GB Gypsum Board
  - IRGB Impact-Resistant Gypsum Board
  - KLCT Kitchen Lay-in Ceiling Tile
  - MMRGB Moisture and Mould-Resistant Gypsum Board
  - SACT Security Acoustic Ceiling Tile
- WALL FINISHES LEGEND:**
- EWC Epoxy Wall Coating
  - HPC High Performance Coating
  - PT Paint
- CEILING FINISHES LEGEND:**
- ECC Epoxy Ceiling Coating
  - HPC High Performance Coating
  - PF Prefinished
  - PT Paint
- WALL PROTECTION LEGEND:**
- ESRP Extruded Semi-Rigid PVCu Panel
  - FRL Fibre Reinforced Laminate
  - FRP Fibreglass Reinforced Plastic
  - PVV Protective Vinyl Wallcovering
  - RHIS Rigid High Impact Sheet
  - WSSP Wetwall Solid Surface Panel
  - WVV Wetroom Vinyl Wallcovering
- FLOOR FINISHES LEGEND:**
- CFS Concrete Floor Sealer
  - EFC Epoxy Floor Coating
  - PFC Polyurethane Floor Coating
  - RAF Rubber Athletic Flooring
  - RSF Rubber Sheet Flooring
  - SCF Seamless Cushioned Flooring
  - SDRF Static-Dissipative Rubber Sheet Flooring
  - SDVF Static-Dissipative Vinyl Sheet Flooring
  - VSF Vinyl Sheet Flooring
  - WSVF Wetroom Safety Vinyl Sheet Flooring
- FLOOR BASE LEGEND:**
- FCB Flash Cove Base
  - RB Rubber Base
  - SCF Seamless Cushioned Flooring

**DOORS**

Types:

Type	Qty	Size (mm)	Material	Finish	Side Lt.	Blinds	Protect.	Privacy Film	Function	Card Reader	Mag Lock	Auto Opener	Hold Open	Hinges	Accessory 1	Accessory 2	Accessory 3	Closer
C	1	1220 x 2135	Solid Core	FRL	<input type="checkbox"/>	<input type="checkbox"/>	2 High	<input type="checkbox"/>	Storeroom	<input checked="" type="checkbox"/>	<input type="checkbox"/>	<input type="checkbox"/>	<input checked="" type="checkbox"/>	Cont. Swing Clear				Surface

Door Remarks:  Security Grille  Anti-barricade strategy

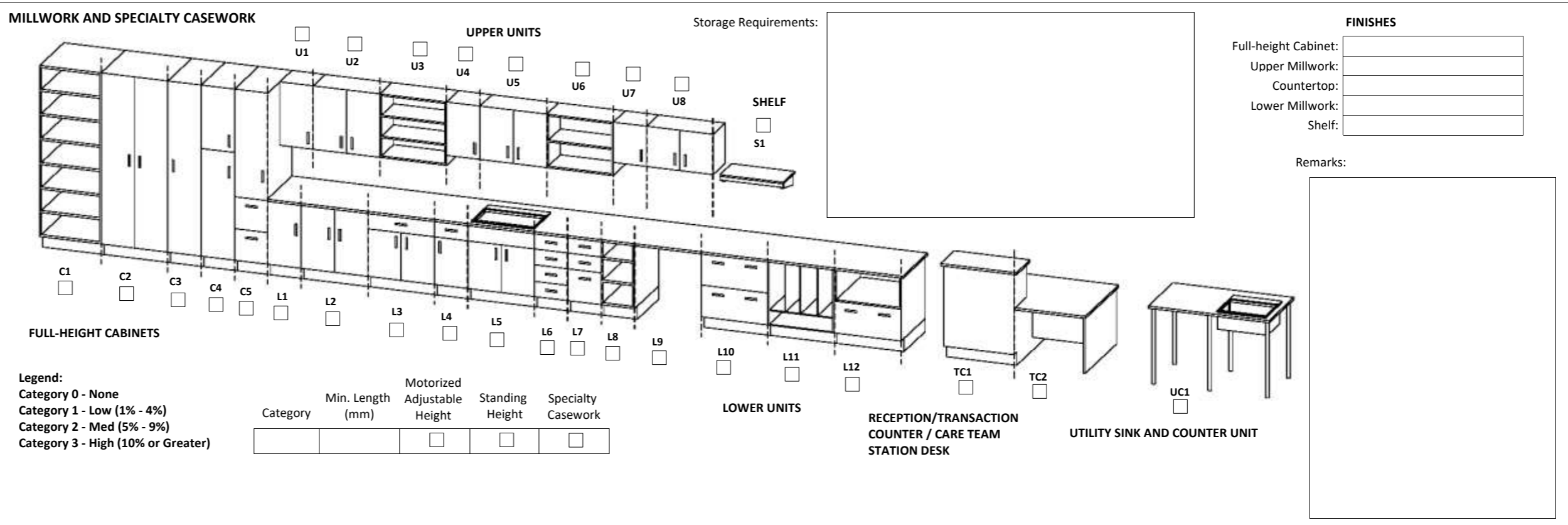

**MECHANICAL REQUIREMENTS**

<b>PLUMBING</b> (Quantity) Hand Hygiene Sink: <input type="text"/> Lavatory: <input type="text"/> Kitchen Sink: <input type="text"/> Seamless Kitchen Sink: <input type="text"/> Utility / Process Sink: <input type="text"/> Scrub Sink: <input type="text"/> Floor Sink: <input type="text"/> Plumbing Remarks: <input type="text"/>		Other Fixtures: <input type="checkbox"/> Shower <input type="checkbox"/> Tub <input type="checkbox"/> Ice Maker <input type="checkbox"/> Water Closet <input type="checkbox"/> Instantaneous Hot Water <input type="checkbox"/> Eyewash Station <input type="checkbox"/> Eyewash/Shower Station <input type="checkbox"/> Emergency Shower <input type="checkbox"/> Flush Rim Sink <input type="checkbox"/> Floor Drain <input type="checkbox"/> Water Bottle Refill Station Other: <input type="text"/>		<b>MED / NON-MED GASES</b> (Quantity) Oxygen: <input type="text"/> Medical Air: <input type="text"/> Medical Vacuum: <input type="text"/> Nitrous Oxide: <input type="text"/> CO2: <input type="text"/> AGSS: <input type="text"/> Nitrogen: <input type="text"/> Laboratory Air: <input type="text"/> Laboratory Vacuum: <input type="text"/> Utility Compressed Air: <input type="text"/> Gas Remarks: <input type="text"/>	
--	--	--	--	---	--

**Appendix 1B Minimum Room Requirements**

Room Name:

Program Number(s):

1. D6.01	7.	13.	19.	25.	31.	37.	43.
2.	8.	14.	20.	26.	32.	38.	44.
3.	9.	15.	21.	27.	33.	39.	45.
4.	10.	16.	22.	28.	34.	40.	46.
5.	11.	17.	23.	29.	35.	41.	47.
6.	12.	18.	24.	30.	36.	42.	48.

**ARCHITECTURAL REQUIREMENTS**

<b>WALL AND CEILING</b> Wall Material: <input type="text" value="ARGB 1.2m AFF, GB above"/> Finish: <input type="text" value="PT"/> Ceiling Material: <input type="text" value="ACT"/> Finish: <input type="text" value="PF"/>	<b>WALL PROTECTION</b> Type: <input type="text" value="ESRP"/> <input checked="" type="checkbox"/> Corner Guards <input type="checkbox"/> Hand Rails <input checked="" type="checkbox"/> Bed Bumper / Locator Height: <input type="text" value="1600 mm"/> <input checked="" type="checkbox"/> Crash Rails <input type="checkbox"/> Chair Rail	<b>GLAZING</b> <input type="checkbox"/> Interior Glazing	<b>FLOORING TYPES</b> Material: <input type="text" value="VSF"/> Base: <input type="text" value="FCB"/>	<b>ROOM ACCESSORIES</b> <input type="checkbox"/> Coat Hooks <input checked="" type="checkbox"/> Ceiling Lift <input checked="" type="checkbox"/> Magnetic Whiteboard <input type="checkbox"/> Mirror <input type="checkbox"/> Infant Change Table <input checked="" type="checkbox"/> Privacy Curtain
--	--	---	--	---

- LEGEND:**
- WALL AND CEILING LEGEND:**
- AC Architectural Ceiling
  - ACT Acoustic Ceiling Tile
  - ACT-C Cleanroom
  - ARGB Abuse-Resistant Gypsum Board
  - GB Gypsum Board
  - IRGB Impact-Resistant Gypsum Board
  - KLCT Kitchen Lay-in Ceiling Tile
  - MMRGB Moisture and Mould-Resistant Gypsum Board
  - SACT Security Acoustic Ceiling Tile
- WALL FINISHES LEGEND:**
- EWC Epoxy Wall Coating
  - HPC High Performance Coating
  - PT Paint
- CEILING FINISHES LEGEND:**
- ECC Epoxy Ceiling Coating
  - HPC High Performance Coating
  - PF Prefinished
  - PT Paint
- WALL PROTECTION LEGEND:**
- ESRP Extruded Semi-Rigid PVCu Panel
  - FRL Fibre Reinforced Laminate
  - FRP Fibreglass Reinforced Plastic
  - PVV Protective Vinyl Wallcovering
  - RHIS Rigid High Impact Sheet
  - WSSP Wetwall Solid Surface Panel
  - WVV Wetroom Vinyl Wallcovering
- FLOOR FINISHES LEGEND:**
- CFS Concrete Floor Sealer
  - EFC Epoxy Floor Coating
  - PFC Polyurethane Floor Coating
  - RAF Rubber Athletic Flooring
  - RSF Rubber Sheet Flooring
  - SCF Seamless Cushioned Flooring
  - SDRF Static-Dissipative Rubber Sheet Flooring
  - SDVF Static-Dissipative Vinyl Sheet Flooring
  - VSF Vinyl Sheet Flooring
  - WSVF Wetroom Safety Vinyl Sheet Flooring
- FLOOR BASE LEGEND:**
- FCB Flash Cove Base
  - RB Rubber Base
  - SCF Seamless Cushioned Flooring

**DOORS**

Types:

Type:Qty:	Size (mm):	Material:	Finish:	Side Lt:	Blinds:	Protect.:	Privacy Film:	Function:	Card Reader:	Mag Lock:	Auto Opener:	Hold Open:	Hinges:	Accessory 1:	Accessory 2:	Accessory 3:	Closer:

Door Remarks:  Security Grille  Anti-barricade strategy

**MILLWORK AND SPECIALTY CASEWORK**

Storage Requirements:

**UPPER UNITS** (U1-U8) **SHELF** (S1)

**LOWER UNITS** (L1-L12) **RECEPTION/TRANSACTION COUNTER / CARE TEAM STATION DESK** (TC1, TC2) **UTILITY SINK AND COUNTER UNIT** (UC1)

**FULL-HEIGHT CABINETS** (C1-C5)

**Legend:**

Category	Min. Length (mm)	Motorized Adjustable Height	Standing Height	Specialty Casework
Category 0 - None				
Category 1 - Low (1% - 4%)				
Category 2 - Med (5% - 9%)				
Category 3 - High (10% or Greater)				

**FINISHES**

Full-height Cabinet:   
 Upper Millwork:   
 Countertop:   
 Lower Millwork:   
 Shelf:

Remarks: Refer to Appendix 1H [Equipment and Furniture] for ceiling lift quantities

**MECHANICAL REQUIREMENTS**

<b>PLUMBING</b> (Quantity) Hand Hygiene Sink: <input type="text"/> Lavatory: <input type="text"/> Kitchen Sink: <input type="text"/> Seamless Kitchen Sink: <input type="text"/> Utility / Process Sink: <input type="text"/> Scrub Sink: <input type="text"/> Floor Sink: <input type="text"/> Plumbing Remarks: <input type="text"/>	Other Fixtures: <input type="checkbox"/> Shower <input type="checkbox"/> Eyewash Station <input type="checkbox"/> Tub <input type="checkbox"/> Eyewash/Shower Station <input type="checkbox"/> Ice Maker <input type="checkbox"/> Emergency Shower <input type="checkbox"/> Water Closet <input type="checkbox"/> Flush Rim Sink <input type="checkbox"/> Instantaneous Hot Water <input type="checkbox"/> Floor Drain <input type="checkbox"/> <input type="checkbox"/> Water Bottle Refill Station Other: <input type="text"/>	<b>MED / NON-MED GASES</b> (Quantity) Oxygen: <input type="text" value="4"/> Medical Air: <input type="text" value="2"/> Medical Vacuum: <input type="text" value="4"/> Nitrous Oxide: <input type="text"/> CO2: <input type="text"/> AGSS: <input type="text"/> Nitrogen: <input type="text"/> Laboratory Air: <input type="text"/> Laboratory Vacuum: <input type="text"/> Utility Compressed Air: <input type="text"/> Gas Remarks: Provide (2) O2, (1) Medical Air, (2) Medical Vacuum each side of bed per stretcher bay.
---	---	---

**Appendix 1B Minimum Room Requirements**

Room Name:

Program Number(s):

1. D6.02	7.	13.	19.	25.	31.	37.	43.
2.	8.	14.	20.	26.	32.	38.	44.
3.	9.	15.	21.	27.	33.	39.	45.
4.	10.	16.	22.	28.	34.	40.	46.
5.	11.	17.	23.	29.	35.	41.	47.
6.	12.	18.	24.	30.	36.	42.	48.

**ARCHITECTURAL REQUIREMENTS**

<b>WALL AND CEILING</b> Wall Material: <input type="text" value="ARGB 1.2m AFF, GB above"/> Finish: <input type="text" value="PT"/> Ceiling Material: <input type="text" value="ACT"/> Finish: <input type="text" value="PF"/>	<b>WALL PROTECTION</b> Type: <input type="text" value="ESRP"/> <input checked="" type="checkbox"/> Corner Guards <input type="checkbox"/> Hand Rails <input checked="" type="checkbox"/> Bed Bumper / Locator Height: <input type="text" value="1600 mm"/> <input checked="" type="checkbox"/> Crash Rails <input type="checkbox"/> Chair Rail	<b>GLAZING</b> <input type="checkbox"/> Interior Glazing	<b>FLOORING TYPES</b> Material: <input type="text" value="VSF"/> Base: <input type="text" value="FCB"/>	<b>ROOM ACCESSORIES</b> <input type="checkbox"/> Coat Hooks <input checked="" type="checkbox"/> Ceiling Lift <input checked="" type="checkbox"/> Magnetic Whiteboard <input type="checkbox"/> Mirror <input type="checkbox"/> Infant Change Table <input checked="" type="checkbox"/> Privacy Curtain
--	--	---	--	---

- LEGEND:**
- WALL AND CEILING LEGEND:**
- AC Architectural Ceiling
  - ACT Acoustic Ceiling Tile
  - ACT-C Cleanroom
  - ARGB Abuse-Resistant Gypsum Board
  - GB Gypsum Board
  - IRGB Impact-Resistant Gypsum Board
  - KLCT Kitchen Lay-in Ceiling Tile
  - MMRGB Moisture and Mould-Resistant Gypsum Board
  - SACT Security Acoustic Ceiling Tile
- WALL FINISHES LEGEND:**
- EWC Epoxy Wall Coating
  - HPC High Performance Coating
  - PT Paint
- CEILING FINISHES LEGEND:**
- ECC Epoxy Ceiling Coating
  - HPC High Performance Coating
  - PF Prefinished
  - PT Paint
- WALL PROTECTION LEGEND:**
- ESRP Extruded Semi-Rigid PVCu Panel
  - FRL Fibre Reinforced Laminate
  - FRP Fibreglass Reinforced Plastic
  - PVV Protective Vinyl Wallcovering
  - RHIS Rigid High Impact Sheet
  - WSSP Wetwall Solid Surface Panel
  - WVV Wetroom Vinyl Wallcovering
- FLOOR FINISHES LEGEND:**
- CFS Concrete Floor Sealer
  - EFC Epoxy Floor Coating
  - PFC Polyurethane Floor Coating
  - RAF Rubber Athletic Flooring
  - RSF Rubber Sheet Flooring
  - SCF Seamless Cushioned Flooring
  - SDRF Static-Dissipative Rubber Sheet Flooring
  - SDVF Static-Dissipative Vinyl Sheet Flooring
  - VSF Vinyl Sheet Flooring
  - WSVF Wetroom Safety Vinyl Sheet Flooring
- FLOOR BASE LEGEND:**
- FCB Flash Cove Base
  - RB Rubber Base
  - SCF Seamless Cushioned Flooring

**DOORS**

Types:

Type	Qty	Size (mm)	Material	Finish	Side Lt	Blinds	Protect	Privacy Film	Function	Card Reader	Mag Lock	Auto Opener	Hold Open	Hinges	Accessory 1	Accessory 2	Accessory 3	Closer	

Door Remarks:  Security Grille  Anti-barricade strategy

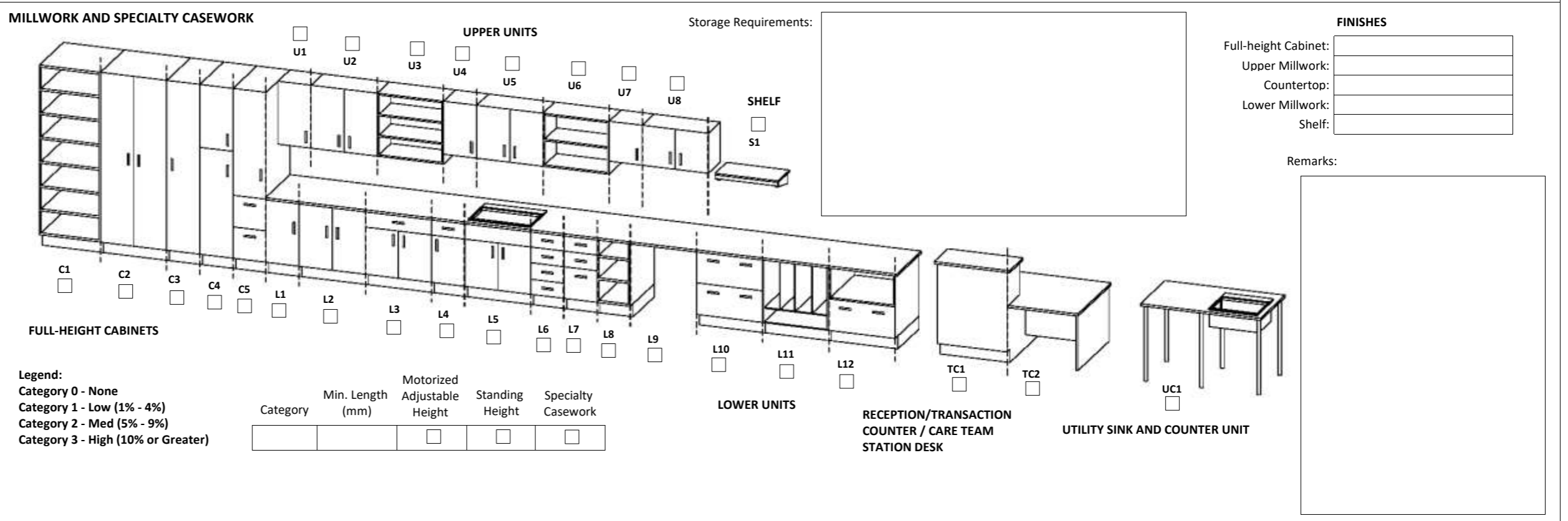

**MECHANICAL REQUIREMENTS**

<b>PLUMBING</b> (Quantity) Hand Hygiene Sink: <input type="text"/> Lavatory: <input type="text"/> Kitchen Sink: <input type="text"/> Seamless Kitchen Sink: <input type="text"/> Utility / Process Sink: <input type="text"/> Scrub Sink: <input type="text"/> Floor Sink: <input type="text"/> Plumbing Remarks: <input type="text"/>	Other Fixtures: <input type="checkbox"/> Shower <input type="checkbox"/> Eyewash Station <input type="checkbox"/> Tub <input type="checkbox"/> Eyewash/Shower Station <input type="checkbox"/> Ice Maker <input type="checkbox"/> Emergency Shower <input type="checkbox"/> Water Closet <input type="checkbox"/> Flush Rim Sink <input type="checkbox"/> Instantaneous Hot Water <input type="checkbox"/> Floor Drain <input type="checkbox"/> <input type="checkbox"/> Water Bottle Refill Station Other <input type="text"/>	<b>MED / NON-MED GASES</b> (Quantity) Oxygen: <input type="text" value="4"/> Medical Air: <input type="text" value="2"/> Medical Vacuum: <input type="text" value="4"/> Nitrous Oxide: <input type="text"/> CO2: <input type="text"/> AGSS: <input type="text"/> Nitrogen: <input type="text"/> Laboratory Air: <input type="text"/> Laboratory Vacuum: <input type="text"/> Utility Compressed Air: <input type="text"/> Gas Remarks: <input type="text" value="Provide (2) O2, (1) Air, (2) Medical Vacuum each side of bed per stretcher bay."/>
---	--	--



**Appendix 1B Minimum Room Requirements**

Room Name:

Program Number(s):

1. D2.17	7.	13.	19.	25.	31.	37.	43.
2.	8.	14.	20.	26.	32.	38.	44.
3.	9.	15.	21.	27.	33.	39.	45.
4.	10.	16.	22.	28.	34.	40.	46.
5.	11.	17.	23.	29.	35.	41.	47.
6.	12.	18.	24.	30.	36.	42.	48.

**ARCHITECTURAL REQUIREMENTS**

<b>WALL AND CEILING</b> Wall Material: <input type="text" value="ARGB 1.2m AFF, GB above"/> Finish: <input type="text" value="PT"/> Ceiling Material: <input type="text" value="ACT"/> Finish: <input type="text" value="PF"/>	<b>WALL PROTECTION</b> Type: <input type="text" value="FRP"/> <input checked="" type="checkbox"/> Corner Guards <input type="checkbox"/> Hand Rails <input type="checkbox"/> Bed Bumper / Locator Height: <input type="text" value="2440 mm"/> <input type="checkbox"/> Crash Rails <input checked="" type="checkbox"/> Chair Rail	<b>GLAZING</b> <input type="checkbox"/> Interior Glazing	<b>FLOORING TYPES</b> Material: <input type="text" value="VSF"/> Base: <input type="text" value="RB"/>	<b>ROOM ACCESSORIES</b> <input checked="" type="checkbox"/> Coat Hooks <input type="checkbox"/> Ceiling Lift <input checked="" type="checkbox"/> Magnetic Whiteboard <input type="checkbox"/> Mirror <input type="checkbox"/> Infant Change Table <input type="checkbox"/> Privacy Curtain
--	--	---	---	--

- LEGEND:**
- WALL AND CEILING LEGEND:**
- AC Architectural Ceiling
  - ACT Acoustic Ceiling Tile
  - ACT-C Cleanroom
  - ARGB Abuse-Resistant Gypsum Board
  - GB Gypsum Board
  - IRGB Impact-Resistant Gypsum Board
  - KLCT Kitchen Lay-in Ceiling Tile
  - MMRGB Moisture and Mould-Resistant Gypsum Board
  - SACT Security Acoustic Ceiling Tile
- WALL FINISHES LEGEND:**
- EWC Epoxy Wall Coating
  - HPC High Performance Coating
  - PT Paint
- CEILING FINISHES LEGEND:**
- ECC Epoxy Ceiling Coating
  - HPC High Performance Coating
  - PF Prefinished
  - PT Paint
- WALL PROTECTION LEGEND:**
- ESRP Extruded Semi-Rigid PVCu Panel
  - FRL Fibre Reinforced Laminate
  - FRP Fibreglass Reinforced Plastic
  - PVV Protective Vinyl Wallcovering
  - RHIS Rigid High Impact Sheet
  - WSSP Wetwall Solid Surface Panel
  - WVV Wetroom Vinyl Wallcovering
- FLOOR FINISHES LEGEND:**
- CFS Concrete Floor Sealer
  - EFC Epoxy Floor Coating
  - PFC Polyurethane Floor Coating
  - RAF Rubber Athletic Flooring
  - RSF Rubber Sheet Flooring
  - SCF Seamless Cushioned Flooring
  - SDRF Static-Dissipative Rubber Sheet Flooring
  - SDVF Static-Dissipative Vinyl Sheet Flooring
  - VSF Vinyl Sheet Flooring
  - WSVF Wetroom Safety Vinyl Sheet Flooring
- FLOOR BASE LEGEND:**
- FCB Flash Cove Base
  - RB Rubber Base
  - SCF Seamless Cushioned Flooring

**DOORS**

Types:

Type	Qty	Size (mm)	Material	Finish	Side Lt.	Blinds	Protect.	Privacy Film	Function	Card Reader	Mag Lock	Auto Opener	Hold Open	Hinges	Accessory 1	Accessory 2	Accessory 3	Closer
C	1	1220 x 2135	Hollow Metal	Paint	<input type="checkbox"/>	<input type="checkbox"/>		<input type="checkbox"/>	Storeroom	<input checked="" type="checkbox"/>	<input type="checkbox"/>	<input type="checkbox"/>	<input type="checkbox"/>	Butt Hinge				Surface

Door Remarks:  Security Grille  Anti-barricade strategy



**MECHANICAL REQUIREMENTS**

<b>PLUMBING</b> (Quantity) Hand Hygiene Sink: <input type="text"/> Lavatory: <input type="text"/> Kitchen Sink: <input type="text"/> Seamless Kitchen Sink: <input type="text"/> Utility / Process Sink: <input type="text"/> Scrub Sink: <input type="text"/> Floor Sink: <input type="text"/> Plumbing Remarks: <input type="text"/>	Other Fixtures: <input type="checkbox"/> Shower <input type="checkbox"/> Eyewash Station <input type="checkbox"/> Tub <input type="checkbox"/> Eyewash/Shower Station <input type="checkbox"/> Ice Maker <input type="checkbox"/> Emergency Shower <input type="checkbox"/> Water Closet <input type="checkbox"/> Flush Rim Sink <input type="checkbox"/> Instantaneous Hot Water <input type="checkbox"/> Floor Drain <input type="checkbox"/> <input type="checkbox"/> Water Bottle Refill Station Other <input type="text"/>	<b>MED / NON-MED GASES</b> (Quantity) Oxygen: <input type="text"/> Medical Air: <input type="text"/> Medical Vacuum: <input type="text"/> Nitrous Oxide: <input type="text"/> CO2: <input type="text"/> AGSS: <input type="text"/> Nitrogen: <input type="text"/> Laboratory Air: <input type="text"/> Laboratory Vacuum: <input type="text"/> Utility Compressed Air: <input type="text"/> Gas Remarks: <input type="text"/>
---	--	---

---

# New Surrey Hospital & BC Cancer Centre

MINIMUM ROOM REQUIREMENTS

## **E. Laboratory Services**

---

**Appendix 1B Minimum Room Requirements**

Room Name:

Program Number(s):

1. E8.06	7.	13.	19.	25.	31.	37.	43.
2.	8.	14.	20.	26.	32.	38.	44.
3.	9.	15.	21.	27.	33.	39.	45.
4.	10.	16.	22.	28.	34.	40.	46.
5.	11.	17.	23.	29.	35.	41.	47.
6.	12.	18.	24.	30.	36.	42.	48.

**ARCHITECTURAL REQUIREMENTS**

<b>WALL AND CEILING</b> Wall Material: <input type="text" value="ARGB 1.2m AFF, GB above"/> Finish: <input type="text" value="PT"/> Ceiling Material: <input type="text" value="ACT-C"/> Finish: <input type="text" value="PF"/>	<b>WALL PROTECTION</b> Type: <input type="text" value="PVW"/> <input checked="" type="checkbox"/> Corner Guards <input type="checkbox"/> Hand Rails <input type="checkbox"/> Bed Bumper / Locator Height: <input type="text" value="2185 mm"/> <input checked="" type="checkbox"/> Crash Rails <input type="checkbox"/> Chair Rail	<b>GLAZING</b> <input type="checkbox"/> Interior Glazing	<b>FLOORING TYPES</b> Material: <input type="text" value="VSF"/> Base: <input type="text" value="FCB"/>	<b>ROOM ACCESSORIES</b> <input type="checkbox"/> Coat Hooks <input type="checkbox"/> Ceiling Lift <input type="checkbox"/> Magnetic Whiteboard <input type="checkbox"/> Mirror <input type="checkbox"/> Infant Change Table <input type="checkbox"/> Privacy Curtain
--	--	---	--	--

- LEGEND:**
- WALL AND CEILING LEGEND:**
- AC Architectural Ceiling
  - ACT Acoustic Ceiling Tile
  - ACT-C Cleanroom
  - ARGB Abuse-Resistant Gypsum Board
  - GB Gypsum Board
  - IRGB Impact-Resistant Gypsum Board
  - KLCT Kitchen Lay-in Ceiling Tile
  - MMRGB Moisture and Mould-Resistant Gypsum Board
  - SACT Security Acoustic Ceiling Tile
- WALL FINISHES LEGEND:**
- EWC Epoxy Wall Coating
  - HPC High Performance Coating
  - PT Paint
- CEILING FINISHES LEGEND:**
- ECC Epoxy Ceiling Coating
  - HPC High Performance Coating
  - PF Prefinished
  - PT Paint
- WALL PROTECTION LEGEND:**
- ESRP Extruded Semi-Rigid PVCu Panel
  - FRL Fibre Reinforced Laminate
  - FRP Fibreglass Reinforced Plastic
  - PVW Protective Vinyl Wallcovering
  - RHIS Rigid High Impact Sheet
  - WSSP Wetwall Solid Surface Panel
  - WVV Wetroom Vinyl Wallcovering
- FLOOR FINISHES LEGEND:**
- CFS Concrete Floor Sealer
  - EFC Epoxy Floor Coating
  - PFC Polyurethane Floor Coating
  - RAF Rubber Athletic Flooring
  - RSF Rubber Sheet Flooring
  - SCF Seamless Cushioned Flooring
  - SDRF Static-Dissipative Rubber Sheet Flooring
  - SDVF Static-Dissipative Vinyl Sheet Flooring
  - VSF Vinyl Sheet Flooring
  - WSVF Wetroom Safety Vinyl Sheet Flooring
- FLOOR BASE LEGEND:**
- FCB Flash Cove Base
  - RB Rubber Base
  - SCF Seamless Cushioned Flooring

**DOORS**

Types:

Type:Qty:	Size (mm):	Material:	Finish:	Side Lt:	Blinds:	Protect.:	Privacy Film:	Function:	Card Reader:	Mag Lock:	Auto Opener:	Hold Open:	Hinges:	Accessory 1:	Accessory 2:	Accessory 3:	Closer:

Door Remarks:  Security Grille  Anti-barricade strategy

**MILLWORK AND SPECIALTY CASEWORK**

Storage Requirements:

**UPPER UNITS** (U1-U8)

**LOWER UNITS** (L1-L12)

**RECEPTION/TRANSACTION COUNTER / CARE TEAM STATION DESK** (TC1, TC2)

**UTILITY SINK AND COUNTER UNIT** (UC1)

**SHelf** (S1)

**Full-height Cabinets** (C1-C5)

**Legend:**

Category	Min. Length (mm)	Motorized Adjustable Height	Standing Height	Specialty Casework
3	3600	<input type="checkbox"/>	<input checked="" type="checkbox"/>	<input type="checkbox"/>

**FINISHES**

Full-height Cabinet:

Upper Millwork:

Countertop:

Lower Millwork:

Shelf:

Remarks:

**MECHANICAL REQUIREMENTS**

<b>PLUMBING</b> (Quantity) Hand Hygiene Sink: <input type="text"/> Lavatory: <input type="text"/> Kitchen Sink: <input type="text"/> Seamless Kitchen Sink: <input type="text"/> Utility / Process Sink: <input type="text"/> Scrub Sink: <input type="text"/> Floor Sink: <input type="text"/> Plumbing Remarks: <input type="text"/>	Other Fixtures: <input type="checkbox"/> Shower <input type="checkbox"/> Tub <input type="checkbox"/> Ice Maker <input type="checkbox"/> Water Closet <input type="checkbox"/> Instantaneous Hot Water <input type="checkbox"/> Eyewash Station <input type="checkbox"/> Eyewash/Shower Station <input type="checkbox"/> Emergency Shower <input type="checkbox"/> Flush Rim Sink <input type="checkbox"/> Floor Drain <input type="checkbox"/> Water Bottle Refill Station Other: <input type="text"/>	<b>MED / NON-MED GASES</b> (Quantity) Oxygen: <input type="text"/> Medical Air: <input type="text"/> Medical Vacuum: <input type="text"/> Nitrous Oxide: <input type="text"/> CO2: <input type="text"/> AGSS: <input type="text"/> Nitrogen: <input type="text"/> Laboratory Air: <input type="text"/> Laboratory Vacuum: <input type="text"/> Utility Compressed Air: <input type="text"/> Gas Remarks: <input type="text"/>
---	--	---



**Appendix 1B Minimum Room Requirements**

Room Name:

Program Number(s):

1.	E3.01.02	7.		13.		19.		25.		31.		37.		43.
2.		8.		14.		20.		26.		32.		38.		44.
3.		9.		15.		21.		27.		33.		39.		45.
4.		10.		16.		22.		28.		34.		40.		46.
5.		11.		17.		23.		29.		35.		41.		47.
6.		12.		18.		24.		30.		36.		42.		48.

**ARCHITECTURAL REQUIREMENTS**

<b>WALL AND CEILING</b> Wall Material: <input type="text" value="ARGB 1.2m AFF, GB above"/> Finish: <input type="text" value="PT"/> Ceiling Material: <input type="text" value="ACT-C"/> Finish: <input type="text" value="PF"/>		<b>WALL PROTECTION</b> Type: <input type="text" value="FRP"/> <input type="checkbox"/> Corner Guards <input type="checkbox"/> Hand Rails <input type="checkbox"/> Bed Bumper / Locator Height: <input type="text" value="2185 mm"/> <input type="checkbox"/> Crash Rails <input type="checkbox"/> Chair Rail			<b>GLAZING</b> <input type="checkbox"/> Interior Glazing		<b>FLOORING TYPES</b> Material: <input type="text" value="VSF"/> Base: <input type="text" value="FCB"/>		<b>ROOM ACCESSORIES</b> <input type="checkbox"/> Coat Hooks <input type="checkbox"/> Ceiling Lift <input checked="" type="checkbox"/> Magnetic Whiteboard <input type="checkbox"/> Mirror <input type="checkbox"/> Infant Change Table <input type="checkbox"/> Privacy Curtain		
--	--	--	--	--	---	--	--	--	---	--	--

- LEGEND:**
- WALL AND CEILING LEGEND:**
- AC Architectural Ceiling
  - ACT Acoustic Ceiling Tile
  - ACT-C Cleanroom
  - ARGB Abuse-Resistant Gypsum Board
  - GB Gypsum Board
  - IRGB Impact-Resistant Gypsum Board
  - KLCT Kitchen Lay-in Ceiling Tile
  - MMRGB Moisture and Mould-Resistant Gypsum Board
  - SACT Security Acoustic Ceiling Tile
- WALL FINISHES LEGEND:**
- EWC Epoxy Wall Coating
  - HPC High Performance Coating
  - PT Paint
- CEILING FINISHES LEGEND:**
- ECC Epoxy Ceiling Coating
  - HPC High Performance Coating
  - PF Prefinished
  - PT Paint
- WALL PROTECTION LEGEND:**
- ESRP Extruded Semi-Rigid PVCu Panel
  - FRL Fibre Reinforced Laminate
  - FRP Fibreglass Reinforced Plastic
  - PVV Protective Vinyl Wallcovering
  - RHIS Rigid High Impact Sheet
  - WSSP Wetwall Solid Surface Panel
  - WVV Wetroom Vinyl Wallcovering
- FLOOR FINISHES LEGEND:**
- CFS Concrete Floor Sealer
  - EFC Epoxy Floor Coating
  - PFC Polyurethane Floor Coating
  - RAF Rubber Athletic Flooring
  - RSF Rubber Sheet Flooring
  - SCF Seamless Cushioned Flooring
  - SDRF Static-Dissipative Rubber Sheet Flooring
  - SDVF Static-Dissipative Vinyl Sheet Flooring
  - VSF Vinyl Sheet Flooring
  - WSVF Wetroom Safety Vinyl Sheet Flooring
- FLOOR BASE LEGEND:**
- FCB Flash Cove Base
  - RB Rubber Base
  - SCF Seamless Cushioned Flooring

**DOORS**

Types:

Type:Qty:	Size (mm):	Material:	Finish:	Side Lt:	Blinds:	Protect.:	Privacy Film:	Function:	Card Reader:	Mag Lock:	Auto Opener:	Hold Open:	Hinges:	Accessory 1:	Accessory 2:	Accessory 3:	Closer:

Door Remarks:  Security Grille  Anti-barricade strategy

**MILLWORK AND SPECIALTY CASEWORK**

Storage Requirements:

**UPPER UNITS** (U1-U8) **SHELF** (S1)

**FULL-HEIGHT CABINETS** (C1-C5, L1-L9)

**LOWER UNITS** (L10-L12) **RECEPTION/TRANSACTION COUNTER / CARE TEAM STATION DESK** (TC1, TC2) **UTILITY SINK AND COUNTER UNIT** (UC1)

Category	Min. Length (mm)	Motorized Adjustable Height	Standing Height	Specialty Casework
3	2700	<input checked="" type="checkbox"/>	<input checked="" type="checkbox"/>	<input checked="" type="checkbox"/>

**FINISHES**

Full-height Cabinet:   
 Upper Millwork:   
 Countertop:   
 Lower Millwork:   
 Shelf:

Remarks: Refer to Schedule 1, Section 6.12 (Division 12) for Specialty Casework. Items indicated are diagrammatic, provide specialty casework appropriate for the specific and specialized functions to be performed in the space and to accommodate Equipment. Provide manual storage and (1) reporting area.

**MECHANICAL REQUIREMENTS**

<b>PLUMBING</b> (Quantity) Hand Hygiene Sink: <input type="text"/> Lavatory: <input type="text"/> Kitchen Sink: <input type="text"/> Seamless Kitchen Sink: <input type="text"/> Utility / Process Sink: <input type="text"/> Scrub Sink: <input type="text"/> Floor Sink: <input type="text"/>							Other Fixtures: <input type="checkbox"/> Shower <input type="checkbox"/> Tub <input type="checkbox"/> Ice Maker <input type="checkbox"/> Water Closet <input type="checkbox"/> Instantaneous Hot Water				<input type="checkbox"/> Eyewash Station <input type="checkbox"/> Eyewash/Shower Station <input type="checkbox"/> Emergency Shower <input type="checkbox"/> Flush Rim Sink <input checked="" type="checkbox"/> Floor Drain <input type="checkbox"/> Water Bottle Refill Station				<b>MED / NON-MED GASES</b> (Quantity) Oxygen: <input type="text"/> Medical Air: <input type="text"/> Medical Vacuum: <input type="text"/> Nitrous Oxide: <input type="text"/> CO2: <input type="text"/> AGSS: <input type="text"/> Nitrogen: <input type="text"/> Laboratory Air: <input type="text"/> Laboratory Vacuum: <input type="text"/> Utility Compressed Air: <input type="text"/>					
Plumbing Remarks: <input type="text"/>							Other: <input type="text"/>				Gas Remarks: <input type="text"/>									

**Appendix 1B Minimum Room Requirements**

Room Name:

Program Number(s):

1. E3.01.05	7.	13.	19.	25.	31.	37.	43.
2.	8.	14.	20.	26.	32.	38.	44.
3.	9.	15.	21.	27.	33.	39.	45.
4.	10.	16.	22.	28.	34.	40.	46.
5.	11.	17.	23.	29.	35.	41.	47.
6.	12.	18.	24.	30.	36.	42.	48.

**ARCHITECTURAL REQUIREMENTS**

<b>WALL AND CEILING</b> Wall Material: <input type="text" value="ARGB 1.2m AFF, GB above"/> Finish: <input type="text" value="PT"/> Ceiling Material: <input type="text" value="ACT-C"/> Finish: <input type="text" value="PF"/>	<b>WALL PROTECTION</b> Type: <input type="text" value="FRP"/> <input type="checkbox"/> Corner Guards <input type="checkbox"/> Hand Rails <input type="checkbox"/> Bed Bumper / Locator Height: <input type="text" value="2185 mm"/> <input type="checkbox"/> Crash Rails <input type="checkbox"/> Chair Rail	<b>GLAZING</b> <input type="checkbox"/> Interior Glazing	<b>FLOORING TYPES</b> Material: <input type="text" value="VSF"/> Base: <input type="text" value="FCB"/>	<b>ROOM ACCESSORIES</b> <input type="checkbox"/> Coat Hooks <input type="checkbox"/> Ceiling Lift <input checked="" type="checkbox"/> Magnetic Whiteboard <input type="checkbox"/> Mirror <input type="checkbox"/> Infant Change Table <input type="checkbox"/> Privacy Curtain
--	--	---	--	---

- LEGEND:**
- WALL AND CEILING LEGEND:**
- AC Architectural Ceiling
  - ACT Acoustic Ceiling Tile
  - ACT-C Cleanroom
  - ARGB Abuse-Resistant Gypsum Board
  - GB Gypsum Board
  - IRGB Impact-Resistant Gypsum Board
  - KLCT Kitchen Lay-in Ceiling Tile
  - MMRGB Moisture and Mould-Resistant Gypsum Board
  - SACT Security Acoustic Ceiling Tile
- WALL FINISHES LEGEND:**
- EWC Epoxy Wall Coating
  - HPC High Performance Coating
  - PT Paint
- CEILING FINISHES LEGEND:**
- ECC Epoxy Ceiling Coating
  - HPC High Performance Coating
  - PF Prefinished
  - PT Paint
- WALL PROTECTION LEGEND:**
- ESRP Extruded Semi-Rigid PVCu Panel
  - FRL Fibre Reinforced Laminate
  - FRP Fibreglass Reinforced Plastic
  - PVV Protective Vinyl Wallcovering
  - RHIS Rigid High Impact Sheet
  - WSSP Wetwall Solid Surface Panel
  - WVV Wetroom Vinyl Wallcovering
- FLOOR FINISHES LEGEND:**
- CFS Concrete Floor Sealer
  - EFC Epoxy Floor Coating
  - PFC Polyurethane Floor Coating
  - RAF Rubber Athletic Flooring
  - RSF Rubber Sheet Flooring
  - SCF Seamless Cushioned Flooring
  - SDRF Static-Dissipative Rubber Sheet Flooring
  - SDVF Static-Dissipative Vinyl Sheet Flooring
  - VSF Vinyl Sheet Flooring
  - WSVF Wetroom Safety Vinyl Sheet Flooring
- FLOOR BASE LEGEND:**
- FCB Flash Cove Base
  - RB Rubber Base
  - SCF Seamless Cushioned Flooring

**DOORS**

Types:

Type:Qty:	Size (mm):	Material:	Finish:	Side Lt:	Blinds:	Protect.:	Privacy Film:	Function:	Card Reader:	Mag Lock:	Auto Opener:	Hold Open:	Hinges:	Accessory 1:	Accessory 2:	Accessory 3:	Closer:

Door Remarks:  Security Grille  Anti-barricade strategy

**MILLWORK AND SPECIALTY CASEWORK**

Storage Requirements:

**UPPER UNITS** (U1-U8)  U1  U2  U3  U4  U5  U6  U7  U8

**LOWER UNITS** (L1-L9)  L1  L2  L3  L4  L5  L6  L7  L8  L9

**RECEPTION/TRANSACTION COUNTER / CARE TEAM STATION DESK** (TC1, TC2)  TC1  TC2

**UTILITY SINK AND COUNTER UNIT** (UC1)  UC1

**FINISHES**

Full-height Cabinet:

Upper Millwork:

Countertop:

Lower Millwork:

Shelf:

Remarks: Refer to Schedule 1, Section 6.12 (Division 12) for Specialty Casework. Items indicated are diagrammatic, provide specialty casework appropriate for the specific and specialized functions to be performed in the space and to accommodate Equipment. Provide laboratory casework, quantity (2) per room to include receiving bench and (2) reporting areas.

Category	Min. Length (mm)	Motorized Adjustable Height	Standing Height	Specialty Casework
3	2700	<input checked="" type="checkbox"/>	<input checked="" type="checkbox"/>	<input checked="" type="checkbox"/>

**MECHANICAL REQUIREMENTS**

<b>PLUMBING</b> (Quantity) Hand Hygiene Sink: <input type="text"/> Lavatory: <input type="text"/> Kitchen Sink: <input type="text"/> Seamless Kitchen Sink: <input type="text"/> Utility / Process Sink: <input type="text"/> Scrub Sink: <input type="text"/> Floor Sink: <input type="text"/> Plumbing Remarks: <input type="text"/>	Other Fixtures: <input type="checkbox"/> Shower <input type="checkbox"/> Tub <input type="checkbox"/> Ice Maker <input type="checkbox"/> Water Closet <input type="checkbox"/> Instantaneous Hot Water <input type="checkbox"/> Ewewash Station <input type="checkbox"/> Eyewash/Shower Station <input type="checkbox"/> Emergency Shower <input type="checkbox"/> Flush Rim Sink <input type="checkbox"/> Floor Drain <input type="checkbox"/> Water Bottle Refill Station Other: <input type="text"/>	<b>MED / NON-MED GASES</b> (Quantity) Oxygen: <input type="text"/> Medical Air: <input type="text"/> Medical Vacuum: <input type="text"/> Nitrous Oxide: <input type="text"/> CO2: <input type="text"/> AGSS: <input type="text"/> Nitrogen: <input type="text"/> Laboratory Air: <input type="text"/> Laboratory Vacuum: <input type="text"/> Utility Compressed Air: <input type="text"/> Gas Remarks: <input type="text"/>
--	--	---

**Appendix 1B Minimum Room Requirements**

Room Name:

Program Number(s):

1. E2.01.01	7.	13.	19.	25.	31.	37.	43.
2.	8.	14.	20.	26.	32.	38.	44.
3.	9.	15.	21.	27.	33.	39.	45.
4.	10.	16.	22.	28.	34.	40.	46.
5.	11.	17.	23.	29.	35.	41.	47.
6.	12.	18.	24.	30.	36.	42.	48.

**ARCHITECTURAL REQUIREMENTS**

<b>WALL AND CEILING</b> Wall Material: <input type="text" value="ARGB 1.2m AFF, GB above"/> Finish: <input type="text" value="PT"/> Ceiling Material: <input type="text" value="ACT-C"/> Finish: <input type="text" value="PF"/>	<b>WALL PROTECTION</b> Type: <input type="text" value="FRP"/> <input type="checkbox"/> Corner Guards <input type="checkbox"/> Hand Rails <input type="checkbox"/> Bed Bumper / Locator Height: <input type="text" value="2185 mm"/> <input type="checkbox"/> Crash Rails <input type="checkbox"/> Chair Rail	<b>GLAZING</b> <input type="checkbox"/> Interior Glazing	<b>FLOORING TYPES</b> Material: <input type="text" value="VSF"/> Base: <input type="text" value="FCB"/>	<b>ROOM ACCESSORIES</b> <input type="checkbox"/> Coat Hooks <input type="checkbox"/> Ceiling Lift <input checked="" type="checkbox"/> Magnetic Whiteboard <input type="checkbox"/> Mirror <input type="checkbox"/> Infant Change Table <input type="checkbox"/> Privacy Curtain
--	--	---	--	---

- LEGEND:**
- WALL AND CEILING LEGEND:**
- AC Architectural Ceiling
  - ACT Acoustic Ceiling Tile
  - ACT-C Cleanroom
  - ARGB Abuse-Resistant Gypsum Board
  - GB Gypsum Board
  - IRGB Impact-Resistant Gypsum Board
  - KLCT Kitchen Lay-in Ceiling Tile
  - MMRGB Moisture and Mould-Resistant Gypsum Board
  - SACT Security Acoustic Ceiling Tile
- WALL FINISHES LEGEND:**
- EWC Epoxy Wall Coating
  - HPC High Performance Coating
  - PT Paint
- CEILING FINISHES LEGEND:**
- ECC Epoxy Ceiling Coating
  - HPC High Performance Coating
  - PF Prefinished
  - PT Paint
- WALL PROTECTION LEGEND:**
- ESRP Extruded Semi-Rigid PVCu Panel
  - FRL Fibre Reinforced Laminate
  - FRP Fibreglass Reinforced Plastic
  - PVV Protective Vinyl Wallcovering
  - RHIS Rigid High Impact Sheet
  - WSSP Wetwall Solid Surface Panel
  - WVV Wetroom Vinyl Wallcovering
- FLOOR FINISHES LEGEND:**
- CFS Concrete Floor Sealer
  - EFC Epoxy Floor Coating
  - PFC Polyurethane Floor Coating
  - RAF Rubber Athletic Flooring
  - RSF Rubber Sheet Flooring
  - SCF Seamless Cushioned Flooring
  - SDRF Static-Dissipative Rubber Sheet Flooring
  - SDVF Static-Dissipative Vinyl Sheet Flooring
  - VSF Vinyl Sheet Flooring
  - WSVF Wetroom Safety Vinyl Sheet Flooring
- FLOOR BASE LEGEND:**
- FCB Flash Cove Base
  - RB Rubber Base
  - SCF Seamless Cushioned Flooring

**DOORS**

Types:

Type:Qty:	Size (mm):	Material:	Finish:	Side Lt:	Blinds:	Protect.:	Privacy Film:	Function:	Card Reader:	Mag Lock:	Auto Opener:	Hold Open:	Hinges:	Accessory 1:	Accessory 2:	Accessory 3:	Closer:

Door Remarks:  Security Grille  Anti-barricade strategy

**MILLWORK AND SPECIALTY CASEWORK**

Storage Requirements:

**UPPER UNITS**

- U1
- U2
- U3
- U4
- U5
- U6
- U7
- U8

**LOWER UNITS**

- L1
- L2
- L3
- L4
- L5
- L6
- L7
- L8
- L9
- L10
- L11
- L12

**RECEPTION/TRANSACTION COUNTER / CARE TEAM STATION DESK**

- TC1
- TC2

**UTILITY SINK AND COUNTER UNIT**

- UC1

**FULL-HEIGHT CABINETS**

- C1
- C2
- C3
- C4
- C5

**Legend:**

Category	Min. Length (mm)	Motorized Adjustable Height	Standing Height	Specialty Casework
1	2700	<input checked="" type="checkbox"/>	<input checked="" type="checkbox"/>	<input checked="" type="checkbox"/>

**FINISHES**

Full-height Cabinet:   
 Upper Millwork:   
 Countertop:   
 Lower Millwork:   
 Shelf:

Remarks: Refer to Schedule 1, Section 6.12 (Division 12) for Specialty Casework. Items indicated are diagrammatic, provide specialty casework appropriate for the specific and specialized functions to be performed in the space and to accommodate Equipment. Provide receiving bench, reporting area, direct orders, evaluation and staging, and LIS workstations.

**MECHANICAL REQUIREMENTS**

<b>PLUMBING</b> (Quantity) Hand Hygiene Sink: <input type="text"/> Lavatory: <input type="text"/> Kitchen Sink: <input type="text"/> Seamless Kitchen Sink: <input type="text"/> Utility / Process Sink: <input type="text" value="1"/> Scrub Sink: <input type="text"/> Floor Sink: <input type="text"/> Plumbing Remarks: <input type="text"/>	Other Fixtures: <input type="checkbox"/> Shower <input type="checkbox"/> Eyewash Station <input type="checkbox"/> Tub <input type="checkbox"/> Eyewash/Shower Station <input type="checkbox"/> Ice Maker <input type="checkbox"/> Emergency Shower <input type="checkbox"/> Water Closet <input type="checkbox"/> Flush Rim Sink <input type="checkbox"/> Instantaneous Hot Water <input type="checkbox"/> Floor Drain <input type="checkbox"/> <input type="checkbox"/> Water Bottle Refill Station Other: <input type="text"/>	<b>MED / NON-MED GASES</b> (Quantity) Oxygen: <input type="text"/> Medical Air: <input type="text"/> Medical Vacuum: <input type="text"/> Nitrous Oxide: <input type="text"/> CO2: <input type="text"/> AGSS: <input type="text"/> Nitrogen: <input type="text"/> Laboratory Air: <input type="text"/> Laboratory Vacuum: <input type="text"/> Utility Compressed Air: <input type="text"/> Gas Remarks: <input type="text"/>
---	---	--



**Appendix 1B Minimum Room Requirements**

Room Name:

Program Number(s):

1. E2.01.02	7.	13.	19.	25.	31.	37.	43.
2.	8.	14.	20.	26.	32.	38.	44.
3.	9.	15.	21.	27.	33.	39.	45.
4.	10.	16.	22.	28.	34.	40.	46.
5.	11.	17.	23.	29.	35.	41.	47.
6.	12.	18.	24.	30.	36.	42.	48.

**ARCHITECTURAL REQUIREMENTS**

<b>WALL AND CEILING</b> Wall Material: <input type="text" value="ARGB 1.2m AFF, GB above"/> Finish: <input type="text" value="PT"/> Ceiling Material: <input type="text" value="ACT-C"/> Finish: <input type="text" value="PF"/>	<b>WALL PROTECTION</b> Type: <input type="text" value="FRP"/> <input type="checkbox"/> Corner Guards <input type="checkbox"/> Hand Rails <input type="checkbox"/> Bed Bumper / Locator Height: <input type="text" value="2185 mm"/> <input type="checkbox"/> Crash Rails <input type="checkbox"/> Chair Rail	<b>GLAZING</b> <input type="checkbox"/> Interior Glazing	<b>FLOORING TYPES</b> Material: <input type="text" value="VSF"/> Base: <input type="text" value="FCB"/>	<b>ROOM ACCESSORIES</b> <input type="checkbox"/> Coat Hooks <input type="checkbox"/> Ceiling Lift <input checked="" type="checkbox"/> Magnetic Whiteboard <input type="checkbox"/> Mirror <input type="checkbox"/> Infant Change Table <input type="checkbox"/> Privacy Curtain
--	--	---	--	---

- LEGEND:**
- WALL AND CEILING LEGEND:**
- AC Architectural Ceiling
  - ACT Acoustic Ceiling Tile
  - ACT-C Cleanroom
  - ARGB Abuse-Resistant Gypsum Board
  - GB Gypsum Board
  - IRGB Impact-Resistant Gypsum Board
  - KLCT Kitchen Lay-in Ceiling Tile
  - MMRGB Moisture and Mould-Resistant Gypsum Board
  - SACT Security Acoustic Ceiling Tile
- WALL FINISHES LEGEND:**
- EWC Epoxy Wall Coating
  - HPC High Performance Coating
  - PT Paint
- CEILING FINISHES LEGEND:**
- ECC Epoxy Ceiling Coating
  - HPC High Performance Coating
  - PF Prefinished
  - PT Paint
- WALL PROTECTION LEGEND:**
- ESRP Extruded Semi-Rigid PVCu Panel
  - FRL Fibre Reinforced Laminate
  - FRP Fibreglass Reinforced Plastic
  - PVV Protective Vinyl Wallcovering
  - RHIS Rigid High Impact Sheet
  - WSSP Wetwall Solid Surface Panel
  - WVV Wetroom Vinyl Wallcovering
- FLOOR FINISHES LEGEND:**
- CFS Concrete Floor Sealer
  - EFC Epoxy Floor Coating
  - PFC Polyurethane Floor Coating
  - RAF Rubber Athletic Flooring
  - RSF Rubber Sheet Flooring
  - SCF Seamless Cushioned Flooring
  - SDRF Static-Dissipative Rubber Sheet Flooring
  - SDVF Static-Dissipative Vinyl Sheet Flooring
  - VSF Vinyl Sheet Flooring
  - WSVF Wetroom Safety Vinyl Sheet Flooring
- FLOOR BASE LEGEND:**
- FCB Flash Cove Base
  - RB Rubber Base
  - SCF Seamless Cushioned Flooring

**DOORS**

Types:

Type	Qty	Size (mm)	Material	Finish	Side Lt.	Blinds	Protect.	Privacy Film	Function	Card Reader	Mag Lock	Auto Opener	Hold Open	Hinges	Accessory 1	Accessory 2	Accessory 3	Closer

Door Remarks:  Security Grille  Anti-barricade strategy

**MILLWORK AND SPECIALTY CASEWORK**

Storage Requirements:

**UPPER UNITS** U1 U2 U3 U4 U5 U6 U7 U8

**LOWER UNITS** L10 L11 L12

**RECEPTION/TRANSACTION COUNTER / CARE TEAM STATION DESK** TC1 TC2

**UTILITY SINK AND COUNTER UNIT** UC1

**SHELF** S1

**FULL-HEIGHT CABINETS** C1 C2 C3 C4 C5

Category	Min. Length (mm)	Motorized Adjustable Height	Standing Height	Specialty Casework
3	2400	<input checked="" type="checkbox"/>	<input checked="" type="checkbox"/>	<input checked="" type="checkbox"/>

**Legend:**  
 Category 0 - None  
 Category 1 - Low (1% - 4%)  
 Category 2 - Med (5% - 9%)  
 Category 3 - High (10% or Greater)

**FINISHES**

Full-height Cabinet:   
 Upper Millwork:   
 Countertop:   
 Lower Millwork:   
 Shelf:

Remarks: Refer to Schedule 1, Section 6.12 (Division 12) for Specialty Casework. Items indicated are diagrammatic, provide specialty casework appropriate for the specific and specialized functions to be performed in the space and to accommodate Equipment.

**MECHANICAL REQUIREMENTS**

<b>PLUMBING</b> (Quantity) Hand Hygiene Sink: <input type="text"/> Lavatory: <input type="text"/> Kitchen Sink: <input type="text"/> Seamless Kitchen Sink: <input type="text"/> Utility / Process Sink: <input type="text" value="1"/> Scrub Sink: <input type="text"/> Floor Sink: <input type="text"/> Plumbing Remarks: <input type="text"/>	Other Fixtures: <input type="checkbox"/> Shower <input type="checkbox"/> Tub <input type="checkbox"/> Ice Maker <input type="checkbox"/> Water Closet <input type="checkbox"/> Instantaneous Hot Water <input type="checkbox"/> Ewwash Station <input type="checkbox"/> Eyewash/Shower Station <input type="checkbox"/> Emergency Shower <input type="checkbox"/> Flush Rim Sink <input type="checkbox"/> Floor Drain <input type="checkbox"/> Water Bottle Refill Station Other: <input type="text"/>	<b>MED / NON-MED GASES</b> (Quantity) Oxygen: <input type="text"/> Medical Air: <input type="text"/> Medical Vacuum: <input type="text"/> Nitrous Oxide: <input type="text"/> CO2: <input type="text"/> AGSS: <input type="text"/> Nitrogen: <input type="text"/> Laboratory Air: <input type="text"/> Laboratory Vacuum: <input type="text"/> Utility Compressed Air: <input type="text"/> Gas Remarks: <input type="text"/>
---	---	---

**Appendix 1B Minimum Room Requirements**

Room Name:

Program Number(s):

1. E3.01.09	7.	13.	19.	25.	31.	37.	43.
2.	8.	14.	20.	26.	32.	38.	44.
3.	9.	15.	21.	27.	33.	39.	45.
4.	10.	16.	22.	28.	34.	40.	46.
5.	11.	17.	23.	29.	35.	41.	47.
6.	12.	18.	24.	30.	36.	42.	48.

**ARCHITECTURAL REQUIREMENTS**

<b>WALL AND CEILING</b> Wall Material: <input type="text" value="ARGB 1.2m AFF, GB above"/> Finish: <input type="text" value="PT"/> Ceiling Material: <input type="text" value="ACT-C"/> Finish: <input type="text" value="PF"/>		<b>WALL PROTECTION</b> Type: <input type="text" value="FRP"/> <input type="checkbox"/> Corner Guards <input type="checkbox"/> Hand Rails <input type="checkbox"/> Bed Bumper / Locator Height: <input type="text" value="2185 mm"/> <input type="checkbox"/> Crash Rails <input type="checkbox"/> Chair Rail			<b>GLAZING</b> <input type="checkbox"/> Interior Glazing		<b>FLOORING TYPES</b> Material: <input type="text" value="VSF"/> Base: <input type="text" value="FCB"/>		<b>ROOM ACCESSORIES</b> <input type="checkbox"/> Coat Hooks <input type="checkbox"/> Ceiling Lift <input checked="" type="checkbox"/> Magnetic Whiteboard <input type="checkbox"/> Mirror <input type="checkbox"/> Infant Change Table <input type="checkbox"/> Privacy Curtain		
--	--	--	--	--	---	--	--	--	---	--	--

- LEGEND:**
- WALL AND CEILING LEGEND:**
- AC Architectural Ceiling
  - ACT Acoustic Ceiling Tile
  - ACT-C Cleanroom
  - ARGB Abuse-Resistant Gypsum Board
  - GB Gypsum Board
  - IRGB Impact-Resistant Gypsum Board
  - KLCT Kitchen Lay-in Ceiling Tile
  - MMRGB Moisture and Mould-Resistant Gypsum Board
  - SACT Security Acoustic Ceiling Tile
- WALL FINISHES LEGEND:**
- EWC Epoxy Wall Coating
  - HPC High Performance Coating
  - PT Paint
- CEILING FINISHES LEGEND:**
- ECC Epoxy Ceiling Coating
  - HPC High Performance Coating
  - PF Prefinished
  - PT Paint
- WALL PROTECTION LEGEND:**
- ESRP Extruded Semi-Rigid PVCu Panel
  - FRL Fibre Reinforced Laminate
  - FRP Fibreglass Reinforced Plastic
  - PVV Protective Vinyl Wallcovering
  - RHIS Rigid High Impact Sheet
  - WSSP Wetwall Solid Surface Panel
  - WWW Wetroom Vinyl Wallcovering
- FLOOR FINISHES LEGEND:**
- CFS Concrete Floor Sealer
  - EFC Epoxy Floor Coating
  - PFC Polyurethane Floor Coating
  - RAF Rubber Athletic Flooring
  - RSF Rubber Sheet Flooring
  - SCF Seamless Cushioned Flooring
  - SDRF Static-Dissipative Rubber Sheet Flooring
  - SDVF Static-Dissipative Vinyl Sheet Flooring
  - VSF Vinyl Sheet Flooring
  - WSVF Wetroom Safety Vinyl Sheet Flooring
- FLOOR BASE LEGEND:**
- FCB Flash Cove Base
  - RB Rubber Base
  - SCF Seamless Cushioned Flooring

**DOORS**

Types:

Type	Qty	Size (mm)	Material	Finish	Side Lt.	Blinds	Protect.	Privacy Film	Function	Card Reader	Mag Lock	Auto Opener	Hold Open	Hinges	Accessory 1	Accessory 2	Accessory 3	Closer

Door Remarks:  Security Grille  Anti-barricade strategy

**MILLWORK AND SPECIALTY CASEWORK**

Storage Requirements:

**UPPER UNITS** (U1-U8)

**LOWER UNITS** (L1-L12)

**RECEPTION/TRANSACTION COUNTER / CARE TEAM STATION DESK** (TC1, TC2)

**UTILITY SINK AND COUNTER UNIT** (UC1)

**FULL-HEIGHT CABINETS** (C1-C5)

**SHELF** (S1)

Category	Min. Length (mm)	Motorized Adjustable Height	Standing Height	Specialty Casework
3	2100	<input checked="" type="checkbox"/>	<input checked="" type="checkbox"/>	<input checked="" type="checkbox"/>

**FINISHES**

Full-height Cabinet:   
 Upper Millwork:   
 Countertop:   
 Lower Millwork:   
 Shelf:

Remarks: Refer to Schedule 1, Section 6.12 (Division 12) for Specialty Casework. Items indicated are diagrammatic, provide specialty casework appropriate for the specific and specialized functions to be performed in the space and to accommodate Equipment. Provide laboratory casework, quantity (1) per room to include receiving bench and (1) reporting area.

**MECHANICAL REQUIREMENTS**

<b>PLUMBING</b> (Quantity)							Hand Hygiene Sink: <input type="text" value="1"/> Lavatory: <input type="text"/> Kitchen Sink: <input type="text"/> Kitchen Sink: <input type="text"/> Utility / Process Sink: <input type="text" value="1"/> Scrub Sink: <input type="text"/> Floor Sink: <input type="text"/>				Other Fixtures: <input type="checkbox"/> Shower <input type="checkbox"/> Tub <input type="checkbox"/> Ice Maker <input type="checkbox"/> Water Closet <input type="checkbox"/> Instantaneous Hot Water				<input type="checkbox"/> Ewewash Station <input type="checkbox"/> Eyewash/Shower Station <input type="checkbox"/> Emergency Shower <input type="checkbox"/> Flush Rim Sink <input type="checkbox"/> Floor Drain <input type="checkbox"/> Water Bottle Refill Station				<b>MED / NON-MED GASES</b> (Quantity)				
Plumbing Remarks: <input type="text"/>															Oxygen: <input type="text"/> Medical Air: <input type="text"/> Medical Vacuum: <input type="text"/> Nitrous Oxide: <input type="text"/> CO2: <input type="text"/> AGSS: <input type="text"/> Nitrogen: <input type="text"/> Laboratory Air: <input type="text"/> Laboratory Vacuum: <input type="text"/> Utility Compressed Air: <input type="text"/>								
															Gas Remarks: <input type="text"/>								

**Appendix 1B Minimum Room Requirements**

Room Name:

Program Number(s):

1. E1.01.04	7.	13.	19.	25.	31.	37.	43.
2.	8.	14.	20.	26.	32.	38.	44.
3.	9.	15.	21.	27.	33.	39.	45.
4.	10.	16.	22.	28.	34.	40.	46.
5.	11.	17.	23.	29.	35.	41.	47.
6.	12.	18.	24.	30.	36.	42.	48.

**ARCHITECTURAL REQUIREMENTS**

<b>WALL AND CEILING</b> Wall Material: <input type="text" value="ARGB 1.2m AFF, GB above"/> Finish: <input type="text" value="PT"/> Ceiling Material: <input type="text" value="ACT-C"/> Finish: <input type="text" value="PF"/>	<b>WALL PROTECTION</b> Type: <input type="text" value="FRP"/> <input type="checkbox"/> Corner Guards <input type="checkbox"/> Hand Rails <input type="checkbox"/> Bed Bumper / Locator Height: <input type="text" value="2185 mm"/> <input type="checkbox"/> Crash Rails <input type="checkbox"/> Chair Rail	<b>GLAZING</b> <input type="checkbox"/> Interior Glazing	<b>FLOORING TYPES</b> Material: <input type="text" value="WSVF"/> Base: <input type="text" value="FCB"/>	<b>ROOM ACCESSORIES</b> <input type="checkbox"/> Coat Hooks <input type="checkbox"/> Ceiling Lift <input type="checkbox"/> Magnetic Whiteboard <input type="checkbox"/> Mirror <input type="checkbox"/> Infant Change Table <input type="checkbox"/> Privacy Curtain
--	--	---	---	--

- LEGEND:**
- WALL AND CEILING LEGEND:**
- AC Architectural Ceiling
  - ACT Acoustic Ceiling Tile
  - ACT-C Cleanroom
  - ARGB Abuse-Resistant Gypsum Board
  - GB Gypsum Board
  - IRGB Impact-Resistant Gypsum Board
  - KLCT Kitchen Lay-in Ceiling Tile
  - MMRGB Moisture and Mould-Resistant Gypsum Board
  - SACT Security Acoustic Ceiling Tile
- WALL FINISHES LEGEND:**
- EWC Epoxy Wall Coating
  - HPC High Performance Coating
  - PT Paint
- CEILING FINISHES LEGEND:**
- ECC Epoxy Ceiling Coating
  - HPC High Performance Coating
  - PF Prefinished
  - PT Paint
- WALL PROTECTION LEGEND:**
- ESRP Extruded Semi-Rigid PVCu Panel
  - FRL Fibre Reinforced Laminate
  - FRP Fibreglass Reinforced Plastic
  - PVV Protective Vinyl Wallcovering
  - RHIS Rigid High Impact Sheet
  - WSSP Wetwall Solid Surface Panel
  - WWW Wetroom Vinyl Wallcovering
- FLOOR FINISHES LEGEND:**
- CFS Concrete Floor Sealer
  - EFC Epoxy Floor Coating
  - PFC Polyurethane Floor Coating
  - RAF Rubber Athletic Flooring
  - RSF Rubber Sheet Flooring
  - SCF Seamless Cushioned Flooring
  - SDRF Static-Dissipative Rubber Sheet Flooring
  - SDVF Static-Dissipative Vinyl Sheet Flooring
  - VSF Vinyl Sheet Flooring
  - WSVF Wetroom Safety Vinyl Sheet Flooring
- FLOOR BASE LEGEND:**
- FCB Flash Cove Base
  - RB Rubber Base
  - SCF Seamless Cushioned Flooring

**DOORS**

Types:

Type:Qty:	Size (mm):	Material:	Finish:	Side Lt:	Blinds:	Protect.:	Privacy Film:	Function:	Card Reader:	Mag Lock:	Auto Opener:	Hold Open:	Hinges:	Accessory 1:	Accessory 2:	Accessory 3:	Closer:

Door Remarks:  Security Grille  Anti-barricade strategy

**MILLWORK AND SPECIALTY CASEWORK**

Storage Requirements:

**UPPER UNITS** (U1-U8)

**LOWER UNITS** (L1-L12)

**RECEPTION/TRANSACTION COUNTER / CARE TEAM STATION DESK** (TC1, TC2)

**UTILITY SINK AND COUNTER UNIT** (UC1)

**FULL-HEIGHT CABINETS** (C1-C5)

**SHELF** (S1)

Category	Min. Length (mm)	Motorized Adjustable Height	Standing Height	Specialty Casework
2	5100	<input checked="" type="checkbox"/>	<input checked="" type="checkbox"/>	<input checked="" type="checkbox"/>

**FINISHES**

Full-height Cabinet:

Upper Millwork:

Countertop:

Lower Millwork:

Shelf:

Remarks: Refer to Schedule 1, Section 6.12 (Division 12) for Specialty Casework. Items indicated are diagrammatic, provide specialty casework appropriate for the specific and specialized functions to be performed in the space and to accommodate Equipment. Provide 4 wkstns @ 5.5 nsm, manual processing area @ 16.5 nsm (3 centrifuges, 2 aliquoting stns, small water bath).

**MECHANICAL REQUIREMENTS**

<b>PLUMBING</b> (Quantity) Hand Hygiene Sink: <input type="text" value="1"/> Lavatory: <input type="text"/> Kitchen Sink: <input type="text"/> Seamless Kitchen Sink: <input type="text"/> Utility / Process Sink: <input type="text" value="1"/> Scrub Sink: <input type="text"/> Floor Sink: <input type="text"/> Plumbing Remarks: Utility sink to include localized acid neutralizer.	Other Fixtures: <input type="checkbox"/> Shower <input type="checkbox"/> Eyewash Station <input type="checkbox"/> Tub <input type="checkbox"/> Eyewash/Shower Station <input type="checkbox"/> Ice Maker <input type="checkbox"/> Emergency Shower <input type="checkbox"/> Water Closet <input type="checkbox"/> Flush Rim Sink <input type="checkbox"/> Instantaneous Hot Water <input type="checkbox"/> Floor Drain <input type="checkbox"/> <input type="checkbox"/> Water Bottle Refill Station Other: <input type="text"/>	<b>MED / NON-MED GASES</b> (Quantity) Oxygen: <input type="text"/> Medical Air: <input type="text"/> Medical Vacuum: <input type="text"/> Nitrous Oxide: <input type="text"/> CO2: <input type="text"/> AGSS: <input type="text"/> Nitrogen: <input type="text"/> Laboratory Air: <input type="text"/> Laboratory Vacuum: <input type="text"/> Utility Compressed Air: <input type="text"/> Gas Remarks: <input type="text"/>
--	---	---



**Appendix 1B Minimum Room Requirements**

Room Name:

Program Number(s):

1. E8.05	7.	13.	19.	25.	31.	37.	43.
2.	8.	14.	20.	26.	32.	38.	44.
3.	9.	15.	21.	27.	33.	39.	45.
4.	10.	16.	22.	28.	34.	40.	46.
5.	11.	17.	23.	29.	35.	41.	47.
6.	12.	18.	24.	30.	36.	42.	48.

**ARCHITECTURAL REQUIREMENTS**

<b>WALL AND CEILING</b> Wall Material: <input type="text" value="ARGB 1.2m AFF, GB above"/> Finish: <input type="text" value="PT"/> Ceiling Material: <input type="text" value="ACT-C"/> Finish: <input type="text" value="PF"/>	<b>WALL PROTECTION</b> Type: <input type="text" value="PVW"/> <input type="checkbox"/> Corner Guards <input type="checkbox"/> Hand Rails <input type="checkbox"/> Bed Bumper / Locator Height: <input type="text" value="2185 mm"/> <input type="checkbox"/> Crash Rails <input type="checkbox"/> Chair Rail	<b>GLAZING</b> <input checked="" type="checkbox"/> Interior Glazing	<b>FLOORING TYPES</b> Material: <input type="text" value="VSF"/> Base: <input type="text" value="FCB"/>	<b>ROOM ACCESSORIES</b> <input checked="" type="checkbox"/> Coat Hooks <input type="checkbox"/> Ceiling Lift <input type="checkbox"/> Magnetic Whiteboard <input type="checkbox"/> Mirror <input type="checkbox"/> Infant Change Table <input checked="" type="checkbox"/> Privacy Curtain
--	--	--	--	--

- LEGEND:**
- WALL AND CEILING LEGEND:**
- AC Architectural Ceiling
  - ACT Acoustic Ceiling Tile
  - ACT-C Cleanroom
  - ARGB Abuse-Resistant Gypsum Board
  - GB Gypsum Board
  - IRGB Impact-Resistant Gypsum Board
  - KLCT Kitchen Lay-in Ceiling Tile
  - MMRGB Moisture and Mould-Resistant Gypsum Board
  - SACT Security Acoustic Ceiling Tile
- WALL FINISHES LEGEND:**
- EWC Epoxy Wall Coating
  - HPC High Performance Coating
  - PT Paint
- CEILING FINISHES LEGEND:**
- ECC Epoxy Ceiling Coating
  - HPC High Performance Coating
  - PF Prefinished
  - PT Paint
- WALL PROTECTION LEGEND:**
- ESRP Extruded Semi-Rigid PVCu Panel
  - FRL Fibre Reinforced Laminate
  - FRP Fibreglass Reinforced Plastic
  - PVW Protective Vinyl Wallcovering
  - RHIS Rigid High Impact Sheet
  - WSSP Wetwall Solid Surface Panel
  - WVV Wetroom Vinyl Wallcovering
- FLOOR FINISHES LEGEND:**
- CFS Concrete Floor Sealer
  - EFC Epoxy Floor Coating
  - PFC Polyurethane Floor Coating
  - RAF Rubber Athletic Flooring
  - RSF Rubber Sheet Flooring
  - SCF Seamless Cushioned Flooring
  - SDRF Static-Dissipative Rubber Sheet Flooring
  - SDVF Static-Dissipative Vinyl Sheet Flooring
  - VSF Vinyl Sheet Flooring
  - WSVF Wetroom Safety Vinyl Sheet Flooring
- FLOOR BASE LEGEND:**
- FCB Flash Cove Base
  - RB Rubber Base
  - SCF Seamless Cushioned Flooring

**DOORS**

Types:

Type:Qty:	Size (mm):	Material:	Finish:	Side Lt:	Blinds:	Protect.:	Privacy Film:	Function:	Card Reader:	Mag Lock:	Auto Opener:	Hold Open:	Hinges:	Accessory 1:	Accessory 2:	Accessory 3:	Closer:

Door Remarks:  Security Grille  Anti-barricade strategy

**MILLWORK AND SPECIALTY CASEWORK**

Storage Requirements:

**UPPER UNITS** (U1-U8) **SHELF** (S1)

**FULL-HEIGHT CABINETS** (C1-C5) **LOWER UNITS** (L1-L12) **RECEPTION/TRANSACTION COUNTER / CARE TEAM STATION DESK** (TC1-TC2) **UTILITY SINK AND COUNTER UNIT** (UC1)

Category	Min. Length (mm)	Motorized Adjustable Height	Standing Height	Specialty Casework
3	900	<input type="checkbox"/>	<input checked="" type="checkbox"/>	<input checked="" type="checkbox"/>

**FINISHES**

Full-height Cabinet:   
 Upper Millwork:   
 Countertop:   
 Lower Millwork:   
 Shelf:

Remarks: Refer to Schedule 1, Section 6.12 (Division 12) for Specialty Casework. Items indicated are diagrammatic, provide specialty casework appropriate for the specific and specialized functions to be performed in the space and to accommodate Equipment.

**MECHANICAL REQUIREMENTS**

<b>PLUMBING</b> (Quantity) Hand Hygiene Sink: <input type="text" value="1"/> Lavatory: <input type="text"/> Kitchen Sink: <input type="text"/> Seamless Kitchen Sink: <input type="text"/> Utility / Process Sink: <input type="text"/> Scrub Sink: <input type="text"/> Floor Sink: <input type="text"/> Plumbing Remarks: <input type="text" value="Provide (1) HHS per (2) stations."/>	Other Fixtures: <input type="checkbox"/> Shower <input type="checkbox"/> Eyewash Station <input type="checkbox"/> Tub <input type="checkbox"/> Eyewash/Shower Station <input type="checkbox"/> Ice Maker <input type="checkbox"/> Emergency Shower <input type="checkbox"/> Water Closet <input type="checkbox"/> Flush Rim Sink <input type="checkbox"/> Instantaneous Hot Water <input type="checkbox"/> Floor Drain <input type="checkbox"/> <input type="checkbox"/> Water Bottle Refill Station Other: <input type="text"/>	<b>MED / NON-MED GASES</b> (Quantity) Oxygen: <input type="text"/> Medical Air: <input type="text"/> Medical Vacuum: <input type="text"/> Nitrous Oxide: <input type="text"/> CO2: <input type="text"/> AGSS: <input type="text"/> Nitrogen: <input type="text"/> Laboratory Air: <input type="text"/> Laboratory Vacuum: <input type="text"/> Utility Compressed Air: <input type="text"/> Gas Remarks: <input type="text"/>
---	---	---

**Appendix 1B Minimum Room Requirements**

Room Name:

Program Number(s):

1. E4.03	7.	13.	19.	25.	31.	37.	43.
2.	8.	14.	20.	26.	32.	38.	44.
3.	9.	15.	21.	27.	33.	39.	45.
4.	10.	16.	22.	28.	34.	40.	46.
5.	11.	17.	23.	29.	35.	41.	47.
6.	12.	18.	24.	30.	36.	42.	48.

**ARCHITECTURAL REQUIREMENTS**

<b>WALL AND CEILING</b> Wall Material: <input type="text"/> Ceiling Material: <input type="text"/> Finish: <input type="text"/> Finish: <input type="text"/>	<b>WALL PROTECTION</b> Type: <input type="text"/> Height: <input type="text"/> <input type="checkbox"/> Corner Guards <input type="checkbox"/> Hand Rails <input type="checkbox"/> Bed Bumper / Locator <input type="checkbox"/> Crash Rails <input type="checkbox"/> Chair Rail	<b>GLAZING</b> <input type="checkbox"/> Interior Glazing	<b>FLOORING TYPES</b> Material: <input type="text"/> Base: <input type="text"/>	<b>ROOM ACCESSORIES</b> <input type="checkbox"/> Coat Hooks <input type="checkbox"/> Ceiling Lift <input type="checkbox"/> Magnetic Whiteboard <input type="checkbox"/> Mirror <input type="checkbox"/> Infant Change Table <input type="checkbox"/> Privacy Curtain
--	--	---	---	--

- LEGEND:**
- WALL AND CEILING LEGEND:**
- AC Architectural Ceiling
  - ACT Acoustic Ceiling Tile
  - ACT-C Cleanroom
  - ARGB Abuse-Resistant Gypsum Board
  - GB Gypsum Board
  - IRGB Impact-Resistant Gypsum Board
  - KLCT Kitchen Lay-in Ceiling Tile
  - MMRGB Moisture and Mould-Resistant Gypsum Board
  - SACT Security Acoustic Ceiling Tile
- WALL FINISHES LEGEND:**
- EWC Epoxy Wall Coating
  - HPC High Performance Coating
  - PT Paint
- CEILING FINISHES LEGEND:**
- ECC Epoxy Ceiling Coating
  - HPC High Performance Coating
  - PF Prefinished
  - PT Paint
- WALL PROTECTION LEGEND:**
- ESRP Extruded Semi-Rigid PVCu Panel
  - FRL Fibre Reinforced Laminate
  - FRP Fibreglass Reinforced Plastic
  - PVV Protective Vinyl Wallcovering
  - RHIS Rigid High Impact Sheet
  - WSSP Wetwall Solid Surface Panel
  - WVV Wetroom Vinyl Wallcovering
- FLOOR FINISHES LEGEND:**
- CFS Concrete Floor Sealer
  - EFC Epoxy Floor Coating
  - PFC Polyurethane Floor Coating
  - RAF Rubber Athletic Flooring
  - RSF Rubber Sheet Flooring
  - SCF Seamless Cushioned Flooring
  - SDRF Static-Dissipative Rubber Sheet Flooring
  - SDVF Static-Dissipative Vinyl Sheet Flooring
  - VSF Vinyl Sheet Flooring
  - WSVF Wetroom Safety Vinyl Sheet Flooring
- FLOOR BASE LEGEND:**
- FCB Flash Cove Base
  - RB Rubber Base
  - SCF Seamless Cushioned Flooring

**DOORS**

Types:

Type:Qty:	Size (mm):	Material:	Finish:	Side Lt:	Blinds:	Protect.:	Privacy Film:	Function:	Card Reader:	Mag Lock:	Auto Opener:	Hold Open:	Hinges:	Accessory 1:	Accessory 2:	Accessory 3:	Closer:

Door Remarks:

Security Grille  
 Anti-barricade strategy

**MILLWORK AND SPECIALTY CASEWORK**

Storage Requirements:

**UPPER UNITS** (U1-U8)

**LOWER UNITS** (L1-L12)

**RECEPTION/TRANSACTION COUNTER / CARE TEAM STATION DESK** (TC1, TC2)

**UTILITY SINK AND COUNTER UNIT** (UC1)

**SHELF** (S1)

**FULL-HEIGHT CABINETS** (C1-C5)

**Legend:**

Category	Min. Length (mm)	Motorized Adjustable Height	Standing Height	Specialty Casework
Category 0 - None				
Category 1 - Low (1% - 4%)				
Category 2 - Med (5% - 9%)				
Category 3 - High (10% or Greater)				

**FINISHES**

Full-height Cabinet:   
 Upper Millwork:   
 Countertop:   
 Lower Millwork:   
 Shelf:

Remarks:

**MECHANICAL REQUIREMENTS**

<b>PLUMBING</b> (Quantity) Hand Hygiene Sink: <input type="text"/> Lavatory: <input type="text"/> Kitchen Sink: <input type="text"/> Seamless Kitchen Sink: <input type="text"/> Utility / Process Sink: <input type="text"/> Scrub Sink: <input type="text"/> Floor Sink: <input type="text"/> Plumbing Remarks: <input type="text"/>	Other Fixtures: <input type="checkbox"/> Shower <input type="checkbox"/> Eyewash Station <input type="checkbox"/> Tub <input type="checkbox"/> Eyewash/Shower Station <input type="checkbox"/> Ice Maker <input type="checkbox"/> Emergency Shower <input type="checkbox"/> Water Closet <input type="checkbox"/> Flush Rim Sink <input type="checkbox"/> Instantaneous Hot Water <input type="checkbox"/> Floor Drain <input type="checkbox"/> <input type="checkbox"/> Water Bottle Refill Station Other: <input type="text"/>	<b>MED / NON-MED GASES</b> (Quantity) Oxygen: <input type="text"/> Medical Air: <input type="text"/> Medical Vacuum: <input type="text"/> Nitrous Oxide: <input type="text"/> CO2: <input type="text"/> AGSS: <input type="text"/> Nitrogen: <input type="text"/> Laboratory Air: <input type="text"/> Laboratory Vacuum: <input type="text"/> Utility Compressed Air: <input type="text"/> Gas Remarks: <input type="text"/>
---	---	---

**Appendix 1B Minimum Room Requirements**

Room Name:

Program Number(s):

1. E3.01.06	7.	13.	19.	25.	31.	37.	43.
2.	8.	14.	20.	26.	32.	38.	44.
3.	9.	15.	21.	27.	33.	39.	45.
4.	10.	16.	22.	28.	34.	40.	46.
5.	11.	17.	23.	29.	35.	41.	47.
6.	12.	18.	24.	30.	36.	42.	48.

**ARCHITECTURAL REQUIREMENTS**

<b>WALL AND CEILING</b> Wall Material: <input type="text" value="ARGB 1.2m AFF, GB above"/> Finish: <input type="text" value="PT"/> Ceiling Material: <input type="text" value="ACT-C"/> Finish: <input type="text" value="PF"/>	<b>WALL PROTECTION</b> Type: <input type="text" value="FRP"/> <input type="checkbox"/> Corner Guards <input type="checkbox"/> Hand Rails <input type="checkbox"/> Bed Bumper / Locator Height: <input type="text" value="2185 mm"/> <input type="checkbox"/> Crash Rails <input type="checkbox"/> Chair Rail	<b>GLAZING</b> <input type="checkbox"/> Interior Glazing	<b>FLOORING TYPES</b> Material: <input type="text" value="VSF"/> Base: <input type="text" value="FCB"/>	<b>ROOM ACCESSORIES</b> <input checked="" type="checkbox"/> Coat Hooks <input type="checkbox"/> Ceiling Lift <input checked="" type="checkbox"/> Magnetic Whiteboard <input type="checkbox"/> Mirror <input type="checkbox"/> Infant Change Table <input type="checkbox"/> Privacy Curtain
--	--	---	--	--

- LEGEND:**
- WALL AND CEILING LEGEND:**
- AC Architectural Ceiling
  - ACT Acoustic Ceiling Tile
  - ACT-C Cleanroom
  - ARGB Abuse-Resistant Gypsum Board
  - GB Gypsum Board
  - IRGB Impact-Resistant Gypsum Board
  - KLCT Kitchen Lay-in Ceiling Tile
  - MMRGB Moisture and Mould-Resistant Gypsum Board
  - SACT Security Acoustic Ceiling Tile
- WALL FINISHES LEGEND:**
- EWC Epoxy Wall Coating
  - HPC High Performance Coating
  - PT Paint
- CEILING FINISHES LEGEND:**
- ECC Epoxy Ceiling Coating
  - HPC High Performance Coating
  - PF Prefinished
  - PT Paint
- WALL PROTECTION LEGEND:**
- ESRP Extruded Semi-Rigid PVCu Panel
  - FRL Fibre Reinforced Laminate
  - FRP Fibreglass Reinforced Plastic
  - PVV Protective Vinyl Wallcovering
  - RHIS Rigid High Impact Sheet
  - WSSP Wetwall Solid Surface Panel
  - WWW Wetroom Vinyl Wallcovering
- FLOOR FINISHES LEGEND:**
- CFS Concrete Floor Sealer
  - EFC Epoxy Floor Coating
  - PFC Polyurethane Floor Coating
  - RAF Rubber Athletic Flooring
  - RSF Rubber Sheet Flooring
  - SCF Seamless Cushioned Flooring
  - SDRF Static-Dissipative Rubber Sheet Flooring
  - SDVF Static-Dissipative Vinyl Sheet Flooring
  - VSF Vinyl Sheet Flooring
  - WSVF Wetroom Safety Vinyl Sheet Flooring
- FLOOR BASE LEGEND:**
- FCB Flash Cove Base
  - RB Rubber Base
  - SCF Seamless Cushioned Flooring

**DOORS**

Types:

Type:Qty:	Size (mm):	Material:	Finish:	Side Lt:	Blinds:	Protect.:	Privacy Film:	Function:	Card Reader:	Mag Lock:	Auto Opener:	Hold Open:	Hinges:	Accessory 1:	Accessory 2:	Accessory 3:	Closer:

Door Remarks:  Security Grille  Anti-barricade strategy

**MILLWORK AND SPECIALTY CASEWORK**

Storage Requirements:

**UPPER UNITS** (U1-U8) **SHELF** (S1)

**FULL-HEIGHT CABINETS** (C1-C5, L1-L9)

**LOWER UNITS** (L10-L12) **RECEPTION/TRANSACTION COUNTER / CARE TEAM STATION DESK** (TC1, TC2) **UTILITY SINK AND COUNTER UNIT** (UC1)

Category	Min. Length (mm)	Motorized Adjustable Height	Standing Height	Specialty Casework
3	2400	<input checked="" type="checkbox"/>	<input checked="" type="checkbox"/>	<input checked="" type="checkbox"/>

**FINISHES**

Full-height Cabinet:   
 Upper Millwork:   
 Countertop:   
 Lower Millwork:   
 Shelf:

Remarks: Refer to Schedule 1, Section 6.12 (Division 12) for Specialty Casework. Items indicated are diagrammatic, provide specialty casework appropriate for the specific and specialized functions to be performed in the space and to accommodate Equipment. Provide set-up bench, centrifuge, and waterbath.

**MECHANICAL REQUIREMENTS**

<b>PLUMBING</b> (Quantity) Hand Hygiene Sink: <input type="text"/> Lavatory: <input type="text"/> Kitchen Sink: <input type="text"/> Seamless Kitchen Sink: <input type="text"/> Utility / Process Sink: <input type="text" value="1"/> Scrub Sink: <input type="text"/> Floor Sink: <input type="text"/> Plumbing Remarks: <input type="text"/>	Other Fixtures: <input type="checkbox"/> Shower <input type="checkbox"/> Tub <input type="checkbox"/> Ice Maker <input type="checkbox"/> Water Closet <input type="checkbox"/> Instantaneous Hot Water <input type="checkbox"/> Eyewash Station <input type="checkbox"/> Eyewash/Shower Station <input type="checkbox"/> Emergency Shower <input type="checkbox"/> Flush Rim Sink <input type="checkbox"/> Floor Drain <input type="checkbox"/> Water Bottle Refill Station Other: <input type="text"/>	<b>MED / NON-MED GASES</b> (Quantity) Oxygen: <input type="text"/> Medical Air: <input type="text"/> Medical Vacuum: <input type="text"/> Nitrous Oxide: <input type="text"/> CO2: <input type="text"/> AGSS: <input type="text"/> Nitrogen: <input type="text"/> Laboratory Air: <input type="text"/> Laboratory Vacuum: <input type="text"/> Utility Compressed Air: <input type="text"/> Gas Remarks: <input type="text"/>
---	--	---



**Appendix 1B Minimum Room Requirements**

Room Name:

Program Number(s):

1. E3.01.08	7.	13.	19.	25.	31.	37.	43.
2.	8.	14.	20.	26.	32.	38.	44.
3.	9.	15.	21.	27.	33.	39.	45.
4.	10.	16.	22.	28.	34.	40.	46.
5.	11.	17.	23.	29.	35.	41.	47.
6.	12.	18.	24.	30.	36.	42.	48.

**ARCHITECTURAL REQUIREMENTS**

<b>WALL AND CEILING</b> Wall Material: <input type="text" value="ARGB 1.2m AFF, GB above"/> Finish: <input type="text" value="PT"/> Ceiling Material: <input type="text" value="ACT-C"/> Finish: <input type="text" value="PF"/>	<b>WALL PROTECTION</b> Type: <input type="text" value="FRP"/> <input type="checkbox"/> Corner Guards <input type="checkbox"/> Hand Rails <input type="checkbox"/> Bed Bumper / Locator Height: <input type="text" value="2185 mm"/> <input type="checkbox"/> Crash Rails <input type="checkbox"/> Chair Rail	<b>GLAZING</b> <input type="checkbox"/> Interior Glazing	<b>FLOORING TYPES</b> Material: <input type="text" value="VSF"/> Base: <input type="text" value="FCB"/>	<b>ROOM ACCESSORIES</b> <input checked="" type="checkbox"/> Coat Hooks <input type="checkbox"/> Ceiling Lift <input checked="" type="checkbox"/> Magnetic Whiteboard <input type="checkbox"/> Mirror <input type="checkbox"/> Infant Change Table <input type="checkbox"/> Privacy Curtain
--	--	---	--	--

- LEGEND:**
- WALL AND CEILING LEGEND:**
- AC Architectural Ceiling
  - ACT Acoustic Ceiling Tile
  - ACT-C Cleanroom
  - ARGB Abuse-Resistant Gypsum Board
  - GB Gypsum Board
  - IRGB Impact-Resistant Gypsum Board
  - KLCT Kitchen Lay-in Ceiling Tile
  - MMRGB Moisture and Mould-Resistant Gypsum Board
  - SACT Security Acoustic Ceiling Tile
- WALL FINISHES LEGEND:**
- EWC Epoxy Wall Coating
  - HPC High Performance Coating
  - PT Paint
- CEILING FINISHES LEGEND:**
- ECC Epoxy Ceiling Coating
  - HPC High Performance Coating
  - PF Prefinished
  - PT Paint
- WALL PROTECTION LEGEND:**
- ESRP Extruded Semi-Rigid PVCu Panel
  - FRL Fibre Reinforced Laminate
  - FRP Fibreglass Reinforced Plastic
  - PVV Protective Vinyl Wallcovering
  - RHIS Rigid High Impact Sheet
  - WSSP Wetwall Solid Surface Panel
  - WWW Wetroom Vinyl Wallcovering
- FLOOR FINISHES LEGEND:**
- CFS Concrete Floor Sealer
  - EFC Epoxy Floor Coating
  - PFC Polyurethane Floor Coating
  - RAF Rubber Athletic Flooring
  - RSF Rubber Sheet Flooring
  - SCF Seamless Cushioned Flooring
  - SDRF Static-Dissipative Rubber Sheet Flooring
  - SDVF Static-Dissipative Vinyl Sheet Flooring
  - VSF Vinyl Sheet Flooring
  - WSVF Wetroom Safety Vinyl Sheet Flooring
- FLOOR BASE LEGEND:**
- FCB Flash Cove Base
  - RB Rubber Base
  - SCF Seamless Cushioned Flooring

**DOORS**

Types:

Type:Qty:	Size (mm):	Material:	Finish:	Side Lt:	Blinds:	Protect.:	Privacy Film:	Function:	Card Reader:	Mag Lock:	Auto Opener:	Hold Open:	Hinges:	Accessory 1:	Accessory 2:	Accessory 3:	Closer:

Door Remarks:  Security Grille  Anti-barricade strategy

**MILLWORK AND SPECIALTY CASEWORK**

Storage Requirements:

**UPPER UNITS** (U1-U8) **SHELF** (S1)

**FULL-HEIGHT CABINETS** (C1-C5, L1-L9)

**LOWER UNITS** (L10-L12) **RECEPTION/TRANSACTION COUNTER / CARE TEAM STATION DESK** (TC1, TC2) **UTILITY SINK AND COUNTER UNIT** (UC1)

Category	Min. Length (mm)	Motorized Adjustable Height	Standing Height	Specialty Casework
1	1500	<input checked="" type="checkbox"/>	<input type="checkbox"/>	<input checked="" type="checkbox"/>

**FINISHES**

Full-height Cabinet:   
 Upper Millwork:   
 Countertop:   
 Lower Millwork:   
 Shelf:

Remarks: Refer to Schedule 1, Section 6.12 (Division 12) for Specialty Casework. Items indicated are diagrammatic, provide specialty casework appropriate for the specific and specialized functions to be performed in the space and to accommodate Equipment. Provide laboratory casework, quantity (4) per room.

**MECHANICAL REQUIREMENTS**

<b>PLUMBING</b> (Quantity) Hand Hygiene Sink: <input type="text"/> Lavatory: <input type="text"/> Kitchen Sink: <input type="text"/> Seamless Kitchen Sink: <input type="text"/> Utility / Process Sink: <input type="text"/> Scrub Sink: <input type="text"/> Floor Sink: <input type="text"/> Plumbing Remarks: <input type="text"/>	Other Fixtures: <input type="checkbox"/> Shower <input type="checkbox"/> Eyewash Station <input type="checkbox"/> Tub <input type="checkbox"/> Eyewash/Shower Station <input type="checkbox"/> Ice Maker <input type="checkbox"/> Emergency Shower <input type="checkbox"/> Water Closet <input type="checkbox"/> Flush Rim Sink <input type="checkbox"/> Instantaneous Hot Water <input type="checkbox"/> Floor Drain <input type="checkbox"/> Water Bottle Refill Station Other: <input type="text"/>	<b>MED / NON-MED GASES</b> (Quantity) Oxygen: <input type="text"/> Medical Air: <input type="text"/> Medical Vacuum: <input type="text"/> Nitrous Oxide: <input type="text"/> CO2: <input type="text"/> AGSS: <input type="text"/> Nitrogen: <input type="text"/> Laboratory Air: <input type="text"/> Laboratory Vacuum: <input type="text"/> Utility Compressed Air: <input type="text"/> Gas Remarks: <input type="text"/>
---	--	---

**Appendix 1B Minimum Room Requirements**

Room Name:

Program Number(s):

1. E5.01.04	7.	13.	19.	25.	31.	37.	43.
2.	8.	14.	20.	26.	32.	38.	44.
3.	9.	15.	21.	27.	33.	39.	45.
4.	10.	16.	22.	28.	34.	40.	46.
5.	11.	17.	23.	29.	35.	41.	47.
6.	12.	18.	24.	30.	36.	42.	48.

**ARCHITECTURAL REQUIREMENTS**

<b>WALL AND CEILING</b> Wall Material: <input type="text"/> Ceiling Material: <input type="text"/> Finish: <input type="text"/> Finish: <input type="text"/>	<b>WALL PROTECTION</b> Type: <input type="text"/> Height: <input type="text"/> <input type="checkbox"/> Corner Guards <input type="checkbox"/> Hand Rails <input type="checkbox"/> Bed Bumper / Locator <input type="checkbox"/> Crash Rails <input type="checkbox"/> Chair Rail	<b>GLAZING</b> <input type="checkbox"/> Interior Glazing	<b>FLOORING TYPES</b> Material: <input type="text"/> Base: <input type="text"/>	<b>ROOM ACCESSORIES</b> <input type="checkbox"/> Coat Hooks <input type="checkbox"/> Ceiling Lift <input type="checkbox"/> Magnetic Whiteboard <input type="checkbox"/> Mirror <input type="checkbox"/> Infant Change Table <input type="checkbox"/> Privacy Curtain
--	--	---	--	--

- LEGEND:**
- WALL AND CEILING LEGEND:**
- AC Architectural Ceiling
  - ACT Acoustic Ceiling Tile
  - ACT-C Cleanroom
  - ARGB Abuse-Resistant Gypsum Board
  - GB Gypsum Board
  - IRGB Impact-Resistant Gypsum Board
  - KLCT Kitchen Lay-in Ceiling Tile
  - MMRGB Moisture and Mould-Resistant Gypsum Board
  - SACT Security Acoustic Ceiling Tile
- WALL FINISHES LEGEND:**
- EWC Epoxy Wall Coating
  - HPC High Performance Coating
  - PT Paint
- CEILING FINISHES LEGEND:**
- ECC Epoxy Ceiling Coating
  - HPC High Performance Coating
  - PF Prefinished
  - PT Paint
- WALL PROTECTION LEGEND:**
- ESRP Extruded Semi-Rigid PVCu Panel
  - FRL Fibre Reinforced Laminate
  - FRP Fibreglass Reinforced Plastic
  - PVV Protective Vinyl Wallcovering
  - RHIS Rigid High Impact Sheet
  - WSSP Wetwall Solid Surface Panel
  - WVV Wetroom Vinyl Wallcovering
- FLOOR FINISHES LEGEND:**
- CFS Concrete Floor Sealer
  - EFC Epoxy Floor Coating
  - PFC Polyurethane Floor Coating
  - RAF Rubber Athletic Flooring
  - RSF Rubber Sheet Flooring
  - SCF Seamless Cushioned Flooring
  - SDRF Static-Dissipative Rubber Sheet Flooring
  - SDVF Static-Dissipative Vinyl Sheet Flooring
  - VSF Vinyl Sheet Flooring
  - WSVF Wetroom Safety Vinyl Sheet Flooring
- FLOOR BASE LEGEND:**
- FCB Flash Cove Base
  - RB Rubber Base
  - SCF Seamless Cushioned Flooring

**DOORS**

Types:

Type:Qty:	Size (mm):	Material:	Finish:	Side Lt:	Blinds:	Protect.:	Privacy Film:	Function:	Card Reader:	Mag Lock:	Auto Opener:	Hold Open:	Hinges:	Accessory 1:	Accessory 2:	Accessory 3:	Closer:

Door Remarks:

Security Grille  
 Anti-barricade strategy

**MILLWORK AND SPECIALTY CASEWORK**

Storage Requirements:

**UPPER UNITS** (U1-U8)

**LOWER UNITS** (L1-L12)

**RECEPTION/TRANSACTION COUNTER / CARE TEAM STATION DESK** (TC1, TC2)

**UTILITY SINK AND COUNTER UNIT** (UC1)

**SHELF** (S1)

**FULL-HEIGHT CABINETS** (C1-C5)

**Legend:**

Category	Min. Length (mm)	Motorized Adjustable Height	Standing Height	Specialty Casework
Category 0 - None				
Category 1 - Low (1% - 4%)				
Category 2 - Med (5% - 9%)				
Category 3 - High (10% or Greater)				

**FINISHES**

Full-height Cabinet:   
 Upper Millwork:   
 Countertop:   
 Lower Millwork:   
 Shelf:

Remarks:

**MECHANICAL REQUIREMENTS**

<b>PLUMBING</b> (Quantity) Hand Hygiene Sink: <input type="text"/> Lavatory: <input type="text"/> Kitchen Sink: <input type="text"/> Kitchen Sink: <input type="text"/> Utility / Process Sink: <input type="text"/> Scrub Sink: <input type="text"/> Floor Sink: <input type="text"/> Plumbing Remarks: <input type="text"/>	Other Fixtures: <input type="checkbox"/> Shower <input type="checkbox"/> Eyewash Station <input type="checkbox"/> Tub <input type="checkbox"/> Eyewash/Shower Station <input type="checkbox"/> Ice Maker <input type="checkbox"/> Emergency Shower <input type="checkbox"/> Water Closet <input type="checkbox"/> Flush Rim Sink <input type="checkbox"/> Instantaneous Hot Water <input type="checkbox"/> Floor Drain <input type="checkbox"/> <input type="checkbox"/> Water Bottle Refill Station Other: <input type="text"/>	<b>MED / NON-MED GASES</b> (Quantity) Oxygen: <input type="text"/> Medical Air: <input type="text"/> Medical Vacuum: <input type="text"/> Nitrous Oxide: <input type="text"/> CO2: <input type="text"/> AGSS: <input type="text"/> Nitrogen: <input type="text"/> Laboratory Air: <input type="text"/> Laboratory Vacuum: <input type="text"/> Utility Compressed Air: <input type="text"/> Gas Remarks: <input type="text"/>
--	---	---

**Appendix 1B Minimum Room Requirements**

Room Name:

Program Number(s):

1. E1.01.06	7.	13.	19.	25.	31.	37.	43.
2.	8.	14.	20.	26.	32.	38.	44.
3.	9.	15.	21.	27.	33.	39.	45.
4.	10.	16.	22.	28.	34.	40.	46.
5.	11.	17.	23.	29.	35.	41.	47.
6.	12.	18.	24.	30.	36.	42.	48.

**ARCHITECTURAL REQUIREMENTS**

<b>WALL AND CEILING</b> Wall Material: <input type="text" value="MMRGB"/> Finish: <input type="text" value="PT"/> Ceiling Material: <input type="text" value="ACT-C"/> Finish: <input type="text" value="PF"/>		<b>WALL PROTECTION</b> Type: <input type="text" value="FRP"/> <input checked="" type="checkbox"/> Corner Guards <input type="checkbox"/> Hand Rails <input type="checkbox"/> Bed Bumper / Locator Height: <input type="text" value="2185 mm"/> <input checked="" type="checkbox"/> Crash Rails <input type="checkbox"/> Chair Rail		<b>GLAZING</b> <input type="checkbox"/> Interior Glazing		<b>FLOORING TYPES</b> Material: <input type="text" value="VSF"/> Base: <input type="text" value="FCB"/>		<b>ROOM ACCESSORIES</b> <input checked="" type="checkbox"/> Coat Hooks <input type="checkbox"/> Ceiling Lift <input type="checkbox"/> Magnetic Whiteboard <input type="checkbox"/> Mirror <input type="checkbox"/> Infant Change Table <input type="checkbox"/> Privacy Curtain	
--	--	--	--	---	--	--	--	---	--

- LEGEND:**
- WALL AND CEILING LEGEND:**
- AC Architectural Ceiling
  - ACT Acoustic Ceiling Tile
  - ACT-C Cleanroom
  - ARGB Abuse-Resistant Gypsum Board
  - GB Gypsum Board
  - IRGB Impact-Resistant Gypsum Board
  - KLCT Kitchen Lay-in Ceiling Tile
  - MMRGB Moisture and Mould-Resistant Gypsum Board
  - SACT Security Acoustic Ceiling Tile
- WALL FINISHES LEGEND:**
- EWC Epoxy Wall Coating
  - HPC High Performance Coating
  - PT Paint
- CEILING FINISHES LEGEND:**
- ECC Epoxy Ceiling Coating
  - HPC High Performance Coating
  - PF Prefinished
  - PT Paint
- WALL PROTECTION LEGEND:**
- ESRP Extruded Semi-Rigid PVCu Panel
  - FRL Fibre Reinforced Laminate
  - FRP Fibreglass Reinforced Plastic
  - PVV Protective Vinyl Wallcovering
  - RHIS Rigid High Impact Sheet
  - WSSP Wetwall Solid Surface Panel
  - WVV Wetroom Vinyl Wallcovering
- FLOOR FINISHES LEGEND:**
- CFS Concrete Floor Sealer
  - EFC Epoxy Floor Coating
  - PFC Polyurethane Floor Coating
  - RAF Rubber Athletic Flooring
  - RSF Rubber Sheet Flooring
  - SCF Seamless Cushioned Flooring
  - SDRF Static-Dissipative Rubber Sheet Flooring
  - SDVF Static-Dissipative Vinyl Sheet Flooring
  - VSF Vinyl Sheet Flooring
  - WSVF Wetroom Safety Vinyl Sheet Flooring
- FLOOR BASE LEGEND:**
- FCB Flash Cove Base
  - RB Rubber Base
  - SCF Seamless Cushioned Flooring

**DOORS**

Types:

Type	Qty	Size (mm)	Material	Finish	Side Lt.	Blinds	Protect.	Privacy Film	Function	Card Reader	Mag Lock	Auto Opener	Hold Open	Hinges	Accessory 1	Accessory 2	Accessory 3	Closer

Door Remarks:  Security Grille  Anti-barricade strategy

**MILLWORK AND SPECIALTY CASEWORK**

**UPPER UNITS** (U1-U8) **LOWER UNITS** (L1-L12) **RECEPTION/TRANSACTION COUNTER / CARE TEAM STATION DESK** (TC1-TC2) **UTILITY SINK AND COUNTER UNIT** (UC1)

Storage Requirements:

**FINISHES**

Full-height Cabinet:   
 Upper Millwork:   
 Countertop:   
 Lower Millwork:   
 Shelf:

Remarks: Refer to Schedule 1, Section 6.12 (Division 12) for Specialty Casework. Items indicated are diagrammatic, provide specialty casework appropriate for the specific and specialized functions to be performed in the space and to accommodate Equipment. Provide packing supplies storage, hazardous materials storage, mail in/out, multifunction copy/ptr, 2 computers, and barcode printer. Refer to Appendix 1A, Section 2.5 Laboratory for lab requirements

Category	Min. Length (mm)	Motorized Adjustable Height	Standing Height	Specialty Casework
3	3000	<input checked="" type="checkbox"/>	<input checked="" type="checkbox"/>	<input checked="" type="checkbox"/>

**MECHANICAL REQUIREMENTS**

<b>PLUMBING</b> (Quantity) Hand Hygiene Sink: <input type="text"/> Lavatory: <input type="text"/> Kitchen Sink: <input type="text"/> Seamless Kitchen Sink: <input type="text"/> Utility / Process Sink: <input type="text"/> Scrub Sink: <input type="text"/> Floor Sink: <input type="text"/> Plumbing Remarks: <input type="text"/>		Other Fixtures: <input type="checkbox"/> Shower <input type="checkbox"/> Tub <input checked="" type="checkbox"/> Ice Maker <input type="checkbox"/> Water Closet <input type="checkbox"/> Instantaneous Hot Water <input type="checkbox"/> Ewewash Station <input type="checkbox"/> Eyewash/Shower Station <input type="checkbox"/> Emergency Shower <input type="checkbox"/> Flush Rim Sink <input type="checkbox"/> Floor Drain <input type="checkbox"/> Water Bottle Refill Station Other: <input type="text"/>		<b>MED / NON-MED GASES</b> (Quantity) Oxygen: <input type="text"/> Medical Air: <input type="text"/> Medical Vacuum: <input type="text"/> Nitrous Oxide: <input type="text"/> CO2: <input type="text"/> AGSS: <input type="text"/> Nitrogen: <input type="text"/> Laboratory Air: <input type="text"/> Laboratory Vacuum: <input type="text"/> Utility Compressed Air: <input type="text"/> Gas Remarks: <input type="text"/>	
--	--	---	--	---	--



**Appendix 1B Minimum Room Requirements**

Room Name:

Program Number(s):	1. E5.02	7.	13.	19.	25.	31.	37.	43.
	2.	8.	14.	20.	26.	32.	38.	44.
	3.	9.	15.	21.	27.	33.	39.	45.
	4.	10.	16.	22.	28.	34.	40.	46.
	5.	11.	17.	23.	29.	35.	41.	47.
	6.	12.	18.	24.	30.	36.	42.	48.

**ARCHITECTURAL REQUIREMENTS**

<b>WALL AND CEILING</b> Wall Material: <input type="text"/> Ceiling Material: <input type="text"/> Finish: <input type="text"/> Finish: <input type="text"/>	<b>WALL PROTECTION</b> Type: <input type="text"/> Height: <input type="text"/> <input type="checkbox"/> Corner Guards <input type="checkbox"/> Hand Rails <input type="checkbox"/> Bed Bumper / Locator <input type="checkbox"/> Crash Rails <input type="checkbox"/> Chair Rail	<b>GLAZING</b> <input type="checkbox"/> Interior Glazing	<b>FLOORING TYPES</b> Material: <input type="text"/> Base: <input type="text"/>	<b>ROOM ACCESSORIES</b> <input type="checkbox"/> Coat Hooks <input type="checkbox"/> Ceiling Lift <input type="checkbox"/> Magnetic Whiteboard <input type="checkbox"/> Mirror <input type="checkbox"/> Infant Change Table <input type="checkbox"/> Privacy Curtain
--	--	---	--	--

- LEGEND:**
- WALL AND CEILING LEGEND:**
- AC Architectural Ceiling
  - ACT Acoustic Ceiling Tile
  - ACT-C Cleanroom
  - ARGB Abuse-Resistant Gypsum Board
  - GB Gypsum Board
  - IRGB Impact-Resistant Gypsum Board
  - KLCT Kitchen Lay-in Ceiling Tile
  - MMRGB Moisture and Mould-Resistant Gypsum Board
  - SACT Security Acoustic Ceiling Tile
- WALL FINISHES LEGEND:**
- EWC Epoxy Wall Coating
  - HPC High Performance Coating
  - PT Paint
- CEILING FINISHES LEGEND:**
- ECC Epoxy Ceiling Coating
  - HPC High Performance Coating
  - PF Prefinished
  - PT Paint
- WALL PROTECTION LEGEND:**
- ESRP Extruded Semi-Rigid PVCu Panel
  - FRL Fibre Reinforced Laminate
  - FRP Fibreglass Reinforced Plastic
  - PVV Protective Vinyl Wallcovering
  - RHIS Rigid High Impact Sheet
  - WSSP Wetwall Solid Surface Panel
  - WVV Wetroom Vinyl Wallcovering
- FLOOR FINISHES LEGEND:**
- CFS Concrete Floor Sealer
  - EFC Epoxy Floor Coating
  - PFC Polyurethane Floor Coating
  - RAF Rubber Athletic Flooring
  - RSF Rubber Sheet Flooring
  - SCF Seamless Cushioned Flooring
  - SDRF Static-Dissipative Rubber Sheet Flooring
  - SDVF Static-Dissipative Vinyl Sheet Flooring
  - VSF Vinyl Sheet Flooring
  - WSVF Wetroom Safety Vinyl Sheet Flooring
- FLOOR BASE LEGEND:**
- FCB Flash Cove Base
  - RB Rubber Base
  - SCF Seamless Cushioned Flooring

**DOORS**

Types:

Type:Qty:	Size (mm):	Material:	Finish:	Side Lt:	Blinds:	Protect.:	Privacy Film:	Function:	Card Reader:	Mag Lock:	Auto Opener:	Hold Open:	Hinges:	Accessory 1:	Accessory 2:	Accessory 3:	Closer:

Door Remarks:

Security Grille  
 Anti-barricade strategy

**MILLWORK AND SPECIALTY CASEWORK**

Storage Requirements:

**UPPER UNITS** (U1-U8)

**LOWER UNITS** (L1-L12)

**RECEPTION/TRANSACTION COUNTER / CARE TEAM STATION DESK** (TC1, TC2)

**UTILITY SINK AND COUNTER UNIT** (UC1)

**SHELF** (S1)

**FULL-HEIGHT CABINETS** (C1-C5)

**Legend:**

Category	Min. Length (mm)	Motorized Adjustable Height	Standing Height	Specialty Casework
Category 0 - None				
Category 1 - Low (1% - 4%)				
Category 2 - Med (5% - 9%)				
Category 3 - High (10% or Greater)				

**FINISHES**

Full-height Cabinet:   
 Upper Millwork:   
 Countertop:   
 Lower Millwork:   
 Shelf:

Remarks:

**MECHANICAL REQUIREMENTS**

<b>PLUMBING</b> (Quantity) Hand Hygiene Sink: <input type="text"/> Lavatory: <input type="text"/> Kitchen Sink: <input type="text"/> Kitchen Sink: <input type="text"/> Utility / Process Sink: <input type="text"/> Scrub Sink: <input type="text"/> Floor Sink: <input type="text"/> Plumbing Remarks: <input type="text"/>	Other Fixtures: <input type="checkbox"/> Shower <input type="checkbox"/> Eyewash Station <input type="checkbox"/> Tub <input type="checkbox"/> Eyewash/Shower Station <input type="checkbox"/> Ice Maker <input type="checkbox"/> Emergency Shower <input type="checkbox"/> Water Closet <input type="checkbox"/> Flush Rim Sink <input type="checkbox"/> Instantaneous Hot Water <input type="checkbox"/> Floor Drain <input type="checkbox"/> <input type="checkbox"/> Water Bottle Refill Station Other: <input type="text"/>	<b>MED / NON-MED GASES</b> (Quantity) Oxygen: <input type="text"/> Medical Air: <input type="text"/> Medical Vacuum: <input type="text"/> Nitrous Oxide: <input type="text"/> CO2: <input type="text"/> AGSS: <input type="text"/> Nitrogen: <input type="text"/> Laboratory Air: <input type="text"/> Laboratory Vacuum: <input type="text"/> Utility Compressed Air: <input type="text"/> Gas Remarks: <input type="text"/>
--	---	---

**Appendix 1B Minimum Room Requirements**

Room Name:

Program Number(s):

1. E2.01.04	7.	13.	19.	25.	31.	37.	43.
2.	8.	14.	20.	26.	32.	38.	44.
3.	9.	15.	21.	27.	33.	39.	45.
4.	10.	16.	22.	28.	34.	40.	46.
5.	11.	17.	23.	29.	35.	41.	47.
6.	12.	18.	24.	30.	36.	42.	48.

**ARCHITECTURAL REQUIREMENTS**

<b>WALL AND CEILING</b> Wall Material: <input type="text" value="ARGB 1.2m AFF, GB above"/> Finish: <input type="text" value="PT"/> Ceiling Material: <input type="text" value="ACT-C"/> Finish: <input type="text" value="PF"/>		<b>WALL PROTECTION</b> Type: <input type="text" value="FRP"/> <input checked="" type="checkbox"/> Corner Guards <input type="checkbox"/> Hand Rails <input type="checkbox"/> Bed Bumper / Locator Height: <input type="text" value="2185 mm"/> <input checked="" type="checkbox"/> Crash Rails <input type="checkbox"/> Chair Rail		<b>GLAZING</b> <input type="checkbox"/> Interior Glazing		<b>FLOORING TYPES</b> Material: <input type="text" value="VSF"/> Base: <input type="text" value="FCB"/>		<b>ROOM ACCESSORIES</b> <input type="checkbox"/> Coat Hooks <input type="checkbox"/> Ceiling Lift <input checked="" type="checkbox"/> Magnetic Whiteboard <input type="checkbox"/> Mirror <input type="checkbox"/> Infant Change Table <input type="checkbox"/> Privacy Curtain	
--	--	--	--	---	--	--	--	---	--

- LEGEND:**
- WALL AND CEILING LEGEND:**
- AC Architectural Ceiling
  - ACT Acoustic Ceiling Tile
  - ACT-C Cleanroom
  - ARGB Abuse-Resistant Gypsum Board
  - GB Gypsum Board
  - IRGB Impact-Resistant Gypsum Board
  - KLCT Kitchen Lay-in Ceiling Tile
  - MMRGB Moisture and Mould-Resistant Gypsum Board
  - SACT Security Acoustic Ceiling Tile
- WALL FINISHES LEGEND:**
- EWC Epoxy Wall Coating
  - HPC High Performance Coating
  - PT Paint
- CEILING FINISHES LEGEND:**
- ECC Epoxy Ceiling Coating
  - HPC High Performance Coating
  - PF Prefinished
  - PT Paint
- WALL PROTECTION LEGEND:**
- ESRP Extruded Semi-Rigid PVCu Panel
  - FRL Fibre Reinforced Laminate
  - FRP Fibreglass Reinforced Plastic
  - PVV Protective Vinyl Wallcovering
  - RHIS Rigid High Impact Sheet
  - WSSP Wetwall Solid Surface Panel
  - WVV Wetroom Vinyl Wallcovering
- FLOOR FINISHES LEGEND:**
- CFS Concrete Floor Sealer
  - EFC Epoxy Floor Coating
  - PFC Polyurethane Floor Coating
  - RAF Rubber Athletic Flooring
  - RSF Rubber Sheet Flooring
  - SCF Seamless Cushioned Flooring
  - SDRF Static-Dissipative Rubber Sheet Flooring
  - SDVF Static-Dissipative Vinyl Sheet Flooring
  - VSF Vinyl Sheet Flooring
  - WSVF Wetroom Safety Vinyl Sheet Flooring
- FLOOR BASE LEGEND:**
- FCB Flash Cove Base
  - RB Rubber Base
  - SCF Seamless Cushioned Flooring

**DOORS**

Types:

Type:Qty:	Size (mm):	Material:	Finish:	Side Lt:	Blinds:	Protect.:	Privacy Film:	Function:	Card Reader:	Mag Lock:	Auto Opener:	Hold Open:	Hinges:	Accessory 1:	Accessory 2:	Accessory 3:	Closer:

Door Remarks:  Security Grille  Anti-barricade strategy

**MILLWORK AND SPECIALTY CASEWORK**

Storage Requirements:

**UPPER UNITS** (U1-U8) **SHELF** (S1)

**FULL-HEIGHT CABINETS** (C1-C5, L1-L9)

**LOWER UNITS** (L10-L12) **RECEPTION/TRANSACTION COUNTER / CARE TEAM STATION DESK** (TC1, TC2) **UTILITY SINK AND COUNTER UNIT** (UC1)

Category	Min. Length (mm)	Motorized Adjustable Height	Standing Height	Specialty Casework
3	1800	<input checked="" type="checkbox"/>	<input checked="" type="checkbox"/>	<input checked="" type="checkbox"/>

**FINISHES**

Full-height Cabinet:   
 Upper Millwork:   
 Countertop:   
 Lower Millwork:   
 Shelf:

Remarks: Refer to Schedule 1, Section 6.12 (Division 12) for Specialty Casework. Items indicated are diagrammatic, provide specialty casework appropriate for the specific and specialized functions to be performed in the space and to accommodate Equipment. Provide receiving bench, reporting area, barcode label ptr, and benchtop equip.

**MECHANICAL REQUIREMENTS**

<b>PLUMBING</b> (Quantity) Hand Hygiene Sink: <input type="text"/> Lavatory: <input type="text"/> Kitchen Sink: <input type="text"/> Seamless Kitchen Sink: <input type="text"/> Utility / Process Sink: <input type="text"/> Scrub Sink: <input type="text"/> Floor Sink: <input type="text"/> Plumbing Remarks: <input type="text"/>							Other Fixtures: <input type="checkbox"/> Shower <input type="checkbox"/> Tub <input type="checkbox"/> Ice Maker <input type="checkbox"/> Water Closet <input type="checkbox"/> Instantaneous Hot Water <input type="checkbox"/> Ewwash Station <input type="checkbox"/> Ewwash/Shower Station <input type="checkbox"/> Emergency Shower <input type="checkbox"/> Flush Rim Sink <input type="checkbox"/> Floor Drain <input type="checkbox"/> Water Bottle Refill Station Other: <input type="text"/>				<b>MED / NON-MED GASES</b> (Quantity) Oxygen: <input type="text"/> Medical Air: <input type="text"/> Medical Vacuum: <input type="text"/> Nitrous Oxide: <input type="text"/> CO2: <input type="text"/> AGSS: <input type="text"/> Nitrogen: <input type="text"/> Laboratory Air: <input type="text"/> Laboratory Vacuum: <input type="text"/> Utility Compressed Air: <input type="text"/> Gas Remarks: <input type="text"/>					
--	--	--	--	--	--	--	--	--	--	--	---	--	--	--	--	--

**Appendix 1B Minimum Room Requirements**

Room Name:

Program Number(s):

1. E3.01.01	7.	13.	19.	25.	31.	37.	43.
2.	8.	14.	20.	26.	32.	38.	44.
3.	9.	15.	21.	27.	33.	39.	45.
4.	10.	16.	22.	28.	34.	40.	46.
5.	11.	17.	23.	29.	35.	41.	47.
6.	12.	18.	24.	30.	36.	42.	48.

**ARCHITECTURAL REQUIREMENTS**

<b>WALL AND CEILING</b> Wall Material: <input type="text" value="ARGB 1.2m AFF, GB above"/> Finish: <input type="text" value="PT"/> Ceiling Material: <input type="text" value="ACT-C"/> Finish: <input type="text" value="PF"/>	<b>WALL PROTECTION</b> Type: <input type="text" value="FRP"/> <input checked="" type="checkbox"/> Corner Guards <input type="checkbox"/> Hand Rails <input type="checkbox"/> Bed Bumper / Locator Height: <input type="text" value="2185 mm"/> <input checked="" type="checkbox"/> Crash Rails <input type="checkbox"/> Chair Rail	<b>GLAZING</b> <input type="checkbox"/> Interior Glazing	<b>FLOORING TYPES</b> Material: <input type="text" value="VSF"/> Base: <input type="text" value="FCB"/>	<b>ROOM ACCESSORIES</b> <input checked="" type="checkbox"/> Coat Hooks <input type="checkbox"/> Ceiling Lift <input checked="" type="checkbox"/> Magnetic Whiteboard <input type="checkbox"/> Mirror <input type="checkbox"/> Infant Change Table <input type="checkbox"/> Privacy Curtain
--	--	---	--	--

- LEGEND:**
- WALL AND CEILING LEGEND:**
- AC Architectural Ceiling
  - ACT Acoustic Ceiling Tile
  - ACT-C Cleanroom
  - ARGB Abuse-Resistant Gypsum Board
  - GB Gypsum Board
  - IRGB Impact-Resistant Gypsum Board
  - KLCT Kitchen Lay-in Ceiling Tile
  - MMRGB Moisture and Mould-Resistant Gypsum Board
  - SACT Security Acoustic Ceiling Tile
- WALL FINISHES LEGEND:**
- EWC Epoxy Wall Coating
  - HPC High Performance Coating
  - PT Paint
- CEILING FINISHES LEGEND:**
- ECC Epoxy Ceiling Coating
  - HPC High Performance Coating
  - PF Prefinished
  - PT Paint
- WALL PROTECTION LEGEND:**
- ESRP Extruded Semi-Rigid PVCu Panel
  - FRL Fibre Reinforced Laminate
  - FRP Fibreglass Reinforced Plastic
  - PVV Protective Vinyl Wallcovering
  - RHIS Rigid High Impact Sheet
  - WSSP Wetwall Solid Surface Panel
  - WVV Wetroom Vinyl Wallcovering
- FLOOR FINISHES LEGEND:**
- CFS Concrete Floor Sealer
  - EFC Epoxy Floor Coating
  - PFC Polyurethane Floor Coating
  - RAF Rubber Athletic Flooring
  - RSF Rubber Sheet Flooring
  - SCF Seamless Cushioned Flooring
  - SDRF Static-Dissipative Rubber Sheet Flooring
  - SDVF Static-Dissipative Vinyl Sheet Flooring
  - VSF Vinyl Sheet Flooring
  - WSVF Wetroom Safety Vinyl Sheet Flooring
- FLOOR BASE LEGEND:**
- FCB Flash Cove Base
  - RB Rubber Base
  - SCF Seamless Cushioned Flooring

**DOORS**

Types:

Type:Qty:	Size (mm):	Material:	Finish:	Side Lt:	Blinds:	Protect.:	Privacy Film:	Function:	Card Reader:	Mag Lock:	Auto Opener:	Hold Open:	Hinges:	Accessory 1:	Accessory 2:	Accessory 3:	Closer:

Door Remarks:  Security Grille  Anti-barricade strategy

**MILLWORK AND SPECIALTY CASEWORK**

**UPPER UNITS** (U1-U8) **LOWER UNITS** (L1-L9)

**RECEPTION/TRANSACTION COUNTER / CARE TEAM STATION DESK** (TC1, TC2)

**UTILITY SINK AND COUNTER UNIT** (UC1)

**Storage Requirements:**  SHELF (S1)

Category	Min. Length (mm)	Motorized Adjustable Height	Standing Height	Specialty Casework
3	1800	<input checked="" type="checkbox"/>	<input checked="" type="checkbox"/>	<input checked="" type="checkbox"/>

**FINISHES**

Full-height Cabinet:   
 Upper Millwork:   
 Countertop:   
 Lower Millwork:   
 Shelf:

Remarks: Refer to Schedule 1, Section 6.12 (Division 12) for Specialty Casework. Items indicated are diagrammatic, provide specialty casework appropriate for the specific and specialized functions to be performed in the space and to accommodate Equipment. Provide sed rate area and 1 computer.

**MECHANICAL REQUIREMENTS**

<b>PLUMBING</b> (Quantity) Hand Hygiene Sink: <input type="text"/> Lavatory: <input type="text"/> Kitchen Sink: <input type="text"/> Seamless Kitchen Sink: <input type="text"/> Utility / Process Sink: <input type="text"/> Scrub Sink: <input type="text"/> Floor Sink: <input type="text"/> Plumbing Remarks: <input type="text"/>	Other Fixtures: <input type="checkbox"/> Shower <input type="checkbox"/> Eyewash Station <input type="checkbox"/> Tub <input type="checkbox"/> Eyewash/Shower Station <input type="checkbox"/> Ice Maker <input type="checkbox"/> Emergency Shower <input type="checkbox"/> Water Closet <input type="checkbox"/> Flush Rim Sink <input type="checkbox"/> Instantaneous Hot Water <input type="checkbox"/> Floor Drain <input type="checkbox"/> <input type="checkbox"/> Water Bottle Refill Station Other: <input type="text"/>	<b>MED / NON-MED GASES</b> (Quantity) Oxygen: <input type="text"/> Medical Air: <input type="text"/> Medical Vacuum: <input type="text"/> Nitrous Oxide: <input type="text"/> CO2: <input type="text"/> AGSS: <input type="text"/> Nitrogen: <input type="text"/> Laboratory Air: <input type="text"/> Laboratory Vacuum: <input type="text"/> Utility Compressed Air: <input type="text"/> Gas Remarks: <input type="text"/>
---	---	--



**Appendix 1B Minimum Room Requirements**

Room Name:

Program Number(s):

1. E4.01.01	7.	13.	19.	25.	31.	37.	43.
2.	8.	14.	20.	26.	32.	38.	44.
3.	9.	15.	21.	27.	33.	39.	45.
4.	10.	16.	22.	28.	34.	40.	46.
5.	11.	17.	23.	29.	35.	41.	47.
6.	12.	18.	24.	30.	36.	42.	48.

**ARCHITECTURAL REQUIREMENTS**

<b>WALL AND CEILING</b> Wall Material: <input type="text" value="ARGB 1.2m AFF, GB above"/> Finish: <input type="text" value="PT"/> Ceiling Material: <input type="text" value="ACT-C"/> Finish: <input type="text" value="PF"/>	<b>WALL PROTECTION</b> Type: <input type="text" value="FRP"/> <input checked="" type="checkbox"/> Corner Guards <input type="checkbox"/> Hand Rails <input type="checkbox"/> Bed Bumper / Locator Height: <input type="text" value="2185 mm"/> <input checked="" type="checkbox"/> Crash Rails <input type="checkbox"/> Chair Rail	<b>GLAZING</b> <input type="checkbox"/> Interior Glazing	<b>FLOORING TYPES</b> Material: <input type="text" value="VSF"/> Base: <input type="text" value="FCB"/>	<b>ROOM ACCESSORIES</b> <input checked="" type="checkbox"/> Coat Hooks <input type="checkbox"/> Ceiling Lift <input checked="" type="checkbox"/> Magnetic Whiteboard <input type="checkbox"/> Mirror <input type="checkbox"/> Infant Change Table <input type="checkbox"/> Privacy Curtain
--	--	---	--	--

- LEGEND:**
- WALL AND CEILING LEGEND:**
- AC Architectural Ceiling
  - ACT Acoustic Ceiling Tile
  - ACT-C Cleanroom
  - ARGB Abuse-Resistant Gypsum Board
  - GB Gypsum Board
  - IRGB Impact-Resistant Gypsum Board
  - KLCT Kitchen Lay-in Ceiling Tile
  - MMRGB Moisture and Mould-Resistant Gypsum Board
  - SACT Security Acoustic Ceiling Tile
- WALL FINISHES LEGEND:**
- EWC Epoxy Wall Coating
  - HPC High Performance Coating
  - PT Paint
- CEILING FINISHES LEGEND:**
- ECC Epoxy Ceiling Coating
  - HPC High Performance Coating
  - PF Prefinished
  - PT Paint
- WALL PROTECTION LEGEND:**
- ESRP Extruded Semi-Rigid PVCu Panel
  - FRL Fibre Reinforced Laminate
  - FRP Fibreglass Reinforced Plastic
  - PVV Protective Vinyl Wallcovering
  - RHIS Rigid High Impact Sheet
  - WSSP Wetwall Solid Surface Panel
  - WVV Wetroom Vinyl Wallcovering
- FLOOR FINISHES LEGEND:**
- CFS Concrete Floor Sealer
  - EFC Epoxy Floor Coating
  - PFC Polyurethane Floor Coating
  - RAF Rubber Athletic Flooring
  - RSF Rubber Sheet Flooring
  - SCF Seamless Cushioned Flooring
  - SDRF Static-Dissipative Rubber Sheet Flooring
  - SDVF Static-Dissipative Vinyl Sheet Flooring
  - VSF Vinyl Sheet Flooring
  - WSVF Wetroom Safety Vinyl Sheet Flooring
- FLOOR BASE LEGEND:**
- FCB Flash Cove Base
  - RB Rubber Base
  - SCF Seamless Cushioned Flooring

**DOORS**

Types:

Type	Qty	Size (mm)	Material	Finish	Side Lt.	Blinds	Protect.	Privacy Film	Function	Card Reader	Mag Lock	Auto Opener	Hold Open	Hinges	Accessory 1	Accessory 2	Accessory 3	Closer

Door Remarks:  Security Grille  Anti-barricade strategy

**MILLWORK AND SPECIALTY CASEWORK**

**UPPER UNITS** (U1-U8) **LOWER UNITS** (L1-L12) **RECEPTION/TRANSACTION COUNTER / CARE TEAM STATION DESK** (TC1-TC2) **UTILITY SINK AND COUNTER UNIT** (UC1)

Storage Requirements:

**FINISHES**

Full-height Cabinet:   
 Upper Millwork:   
 Countertop:   
 Lower Millwork:   
 Shelf:

Remarks: Refer to Schedule 1, Section 6.12 (Division 12) for Specialty Casework. Items indicated are diagrammatic, provide specialty casework appropriate for the specific and specialized functions to be performed in the space and to accommodate Equipment. Provide area for up to 14 CBS boxes, centrifuge, 2 computers/scanners/label ptrs, work area, multifunction copy/ptr, and 2 file cabinets.

Category	Min. Length (mm)	Motorized Adjustable Height	Standing Height	Specialty Casework
2	1800	<input checked="" type="checkbox"/>	<input checked="" type="checkbox"/>	<input checked="" type="checkbox"/>

**MECHANICAL REQUIREMENTS**

<b>PLUMBING</b> (Quantity) Hand Hygiene Sink: <input type="text"/> Lavatory: <input type="text"/> Kitchen Sink: <input type="text"/> Seamless Kitchen Sink: <input type="text"/> Utility / Process Sink: <input type="text"/> Scrub Sink: <input type="text"/> Floor Sink: <input type="text"/> Plumbing Remarks: <input type="text"/>	Other Fixtures: <input type="checkbox"/> Shower <input type="checkbox"/> Eyewash Station <input type="checkbox"/> Tub <input type="checkbox"/> Eyewash/Shower Station <input type="checkbox"/> Ice Maker <input type="checkbox"/> Emergency Shower <input type="checkbox"/> Water Closet <input type="checkbox"/> Flush Rim Sink <input type="checkbox"/> Instantaneous Hot Water <input type="checkbox"/> Floor Drain <input type="checkbox"/> <input type="checkbox"/> Water Bottle Refill Station Other: <input type="text"/>	<b>MED / NON-MED GASES</b> (Quantity) Oxygen: <input type="text"/> Medical Air: <input type="text"/> Medical Vacuum: <input type="text"/> Nitrous Oxide: <input type="text"/> CO2: <input type="text"/> AGSS: <input type="text"/> Nitrogen: <input type="text"/> Laboratory Air: <input type="text"/> Laboratory Vacuum: <input type="text"/> Utility Compressed Air: <input type="text"/> Gas Remarks: <input type="text"/>
---	---	---

**Appendix 1B Minimum Room Requirements**

Room Name:

Program Number(s):

1. E4.04	7.	13.	19.	25.	31.	37.	43.
2.	8.	14.	20.	26.	32.	38.	44.
3.	9.	15.	21.	27.	33.	39.	45.
4.	10.	16.	22.	28.	34.	40.	46.
5.	11.	17.	23.	29.	35.	41.	47.
6.	12.	18.	24.	30.	36.	42.	48.

**ARCHITECTURAL REQUIREMENTS**

<b>WALL AND CEILING</b> Wall Material: <input type="text" value="ARGB 1.2m AFF, GB above"/> Finish: <input type="text" value="PT"/> Ceiling Material: <input type="text" value="ACT-C"/> Finish: <input type="text" value="PF"/>		<b>WALL PROTECTION</b> Type: <input type="text" value="FRP"/> <input checked="" type="checkbox"/> Corner Guards <input type="checkbox"/> Hand Rails <input type="checkbox"/> Bed Bumper / Locator Height: <input type="text" value="2185 mm"/> <input type="checkbox"/> Crash Rails <input type="checkbox"/> Chair Rail		<b>GLAZING</b> <input type="checkbox"/> Interior Glazing		<b>FLOORING TYPES</b> Material: <input type="text" value="WSVF"/> Base: <input type="text" value="FCB"/>		<b>ROOM ACCESSORIES</b> <input type="checkbox"/> Coat Hooks <input type="checkbox"/> Ceiling Lift <input type="checkbox"/> Magnetic Whiteboard <input type="checkbox"/> Mirror <input type="checkbox"/> Infant Change Table <input type="checkbox"/> Privacy Curtain	
--	--	---	--	---	--	---	--	--	--

- LEGEND:**
- WALL AND CEILING LEGEND:**
- AC Architectural Ceiling
  - ACT Acoustic Ceiling Tile
  - ACT-C Cleanroom
  - ARGB Abuse-Resistant Gypsum Board
  - GB Gypsum Board
  - IRGB Impact-Resistant Gypsum Board
  - KLCT Kitchen Lay-in Ceiling Tile
  - MMRGB Moisture and Mould-Resistant Gypsum Board
  - SACT Security Acoustic Ceiling Tile
- WALL FINISHES LEGEND:**
- EWC Epoxy Wall Coating
  - HPC High Performance Coating
  - PT Paint
- CEILING FINISHES LEGEND:**
- ECC Epoxy Ceiling Coating
  - HPC High Performance Coating
  - PF Prefinished
  - PT Paint
- WALL PROTECTION LEGEND:**
- ESRP Extruded Semi-Rigid PVCu Panel
  - FRL Fibre Reinforced Laminate
  - FRP Fibreglass Reinforced Plastic
  - PVV Protective Vinyl Wallcovering
  - RHIS Rigid High Impact Sheet
  - WSSP Wetwall Solid Surface Panel
  - WVV Wetroom Vinyl Wallcovering
- FLOOR FINISHES LEGEND:**
- CFS Concrete Floor Sealer
  - EFC Epoxy Floor Coating
  - PFC Polyurethane Floor Coating
  - RAF Rubber Athletic Flooring
  - RSF Rubber Sheet Flooring
  - SCF Seamless Cushioned Flooring
  - SDRF Static-Dissipative Rubber Sheet Flooring
  - SDVF Static-Dissipative Vinyl Sheet Flooring
  - VSF Vinyl Sheet Flooring
  - WSVF Wetroom Safety Vinyl Sheet Flooring
- FLOOR BASE LEGEND:**
- FCB Flash Cove Base
  - RB Rubber Base
  - SCF Seamless Cushioned Flooring

**DOORS**

Types:

Type	Qty	Size (mm)	Material	Finish	Side Lt.	Blinds	Protect.	Privacy Film	Function	Card Reader	Mag Lock	Auto Opener	Hold Open	Hinges	Accessory 1	Accessory 2	Accessory 3	Closer

Door Remarks:  Security Grille  Anti-barricade strategy



**MECHANICAL REQUIREMENTS**

<b>PLUMBING</b> (Quantity) Hand Hygiene Sink: <input type="text"/> Lavatory: <input type="text"/> Kitchen Sink: <input type="text"/> Seamless Kitchen Sink: <input type="text"/> Utility / Process Sink: <input type="text"/> Scrub Sink: <input type="text"/> Floor Sink: <input type="text"/>		Other Fixtures: <input type="checkbox"/> Shower <input type="checkbox"/> Eyewash Station <input type="checkbox"/> Tub <input type="checkbox"/> Eyewash/Shower Station <input type="checkbox"/> Ice Maker <input type="checkbox"/> Emergency Shower <input type="checkbox"/> Water Closet <input checked="" type="checkbox"/> Floor Drain <input type="checkbox"/> Instantaneous Hot Water <input type="checkbox"/> Water Bottle Refill Station Other: <input type="text"/>		<b>MED / NON-MED GASES</b> (Quantity) Oxygen: <input type="text"/> Medical Air: <input type="text"/> Medical Vacuum: <input type="text"/> Nitrous Oxide: <input type="text"/> CO2: <input type="text"/> AGSS: <input type="text"/> Nitrogen: <input type="text"/> Laboratory Air: <input type="text"/> Laboratory Vacuum: <input type="text"/> Utility Compressed Air: <input type="text"/>	
Plumbing Remarks: <input type="text"/>		Gas Remarks: <input type="text"/>			

# Appendix 1B Minimum Room Requirements

Room Name:

Program Number(s):

1. E3.02	7.	13.	19.	25.	31.	37.	43.
2.	8.	14.	20.	26.	32.	38.	44.
3.	9.	15.	21.	27.	33.	39.	45.
4.	10.	16.	22.	28.	34.	40.	46.
5.	11.	17.	23.	29.	35.	41.	47.
6.	12.	18.	24.	30.	36.	42.	48.

## ARCHITECTURAL REQUIREMENTS

<b>WALL AND CEILING</b> Wall Material: <input type="text" value="ARGB 1.2m AFF, GB above"/> Finish: <input type="text" value="HPC"/> Ceiling Material: <input type="text" value="ACT-C"/> Finish: <input type="text" value="PF"/>	<b>WALL PROTECTION</b> Type: <input type="text" value="FRP"/> <input checked="" type="checkbox"/> Corner Guards <input type="checkbox"/> Hand Rails <input type="checkbox"/> Bed Bumper / Locator Height: <input type="text" value="2185 mm"/> <input type="checkbox"/> Crash Rails <input type="checkbox"/> Chair Rail	<b>GLAZING</b> <input type="checkbox"/> Interior Glazing	<b>FLOORING TYPES</b> Material: <input type="text" value="WSVF"/> Base: <input type="text" value="FCB"/>	<b>ROOM ACCESSORIES</b> <input type="checkbox"/> Coat Hooks <input type="checkbox"/> Ceiling Lift <input type="checkbox"/> Magnetic Whiteboard <input type="checkbox"/> Mirror <input type="checkbox"/> Infant Change Table <input type="checkbox"/> Privacy Curtain
---	---	---	---	--

- LEGEND:**
- WALL AND CEILING LEGEND:**
- AC Architectural Ceiling
  - ACT Acoustic Ceiling Tile
  - ACT-C Cleanroom
  - ARGB Abuse-Resistant Gypsum Board
  - GB Gypsum Board
  - IRGB Impact-Resistant Gypsum Board
  - KLCT Kitchen Lay-in Ceiling Tile
  - MMRGB Moisture and Mould-Resistant Gypsum Board
  - SACT Security Acoustic Ceiling Tile
- WALL FINISHES LEGEND:**
- EWC Epoxy Wall Coating
  - HPC High Performance Coating
  - PT Paint
- CEILING FINISHES LEGEND:**
- ECC Epoxy Ceiling Coating
  - HPC High Performance Coating
  - PF Prefinished
  - PT Paint
- WALL PROTECTION LEGEND:**
- ESRP Extruded Semi-Rigid PVCu Panel
  - FRL Fibre Reinforced Laminate
  - FRP Fibreglass Reinforced Plastic
  - PVV Protective Vinyl Wallcovering
  - RHIS Rigid High Impact Sheet
  - WSSP Wetwall Solid Surface Panel
  - WVV Wetroom Vinyl Wallcovering
- FLOOR FINISHES LEGEND:**
- CFS Concrete Floor Sealer
  - EFC Epoxy Floor Coating
  - PFC Polyurethane Floor Coating
  - RAF Rubber Athletic Flooring
  - RSF Rubber Sheet Flooring
  - SCF Seamless Cushioned Flooring
  - SDRF Static-Dissipative Rubber Sheet Flooring
  - SDVF Static-Dissipative Vinyl Sheet Flooring
  - VSF Vinyl Sheet Flooring
  - WSVF Wetroom Safety Vinyl Sheet Flooring
- FLOOR BASE LEGEND:**
- FCB Flash Cove Base
  - RB Rubber Base
  - SCF Seamless Cushioned Flooring

**DOORS**

Types:

Type	Qty	Size (mm)	Material	Finish	Side Lt.	Blinds	Protect.	Privacy Film	Function	Card Reader	Mag Lock	Auto Opener	Hold Open	Hinges	Accessory 1	Accessory 2	Accessory 3	Closer	

Door Remarks:

Security Grille  
 Anti-barricade strategy

**MILLWORK AND SPECIALTY CASEWORK**

Storage Requirements:

**UPPER UNITS** (U1-U8) **SHELF** (S1)

**FULL-HEIGHT CABINETS** (C1-C5) **LOWER UNITS** (L1-L12) **RECEPTION/TRANSACTION COUNTER / CARE TEAM STATION DESK** (TC1-TC2) **UTILITY SINK AND COUNTER UNIT** (UC1)

**Legend:**

Category	Min. Length (mm)	Motorized Adjustable Height	Standing Height	Specialty Casework
Category 0 - None				
Category 1 - Low (1% - 4%)				
Category 2 - Med (5% - 9%)				
Category 3 - High (10% or Greater)				

**FINISHES**

Full-height Cabinet:   
 Upper Millwork:   
 Countertop:   
 Lower Millwork:   
 Shelf:

Remarks:

## MECHANICAL REQUIREMENTS

**PLUMBING** (Quantity)

Hand Hygiene Sink:	Lavatory:	Kitchen Sink:	Seamless Kitchen Sink:	Utility / Process Sink:	Scrub Sink:	Floor Sink:
<input type="text"/>	<input type="text"/>	<input type="text"/>	<input type="text"/>	<input type="text"/>	<input type="text"/>	<input type="text"/>

Plumbing Remarks:

**Other Fixtures:**

- Shower
- Tub
- Ice Maker
- Water Closet
- Instantaneous Hot Water
- Eyewash Station
- Eyewash/Shower Station
- Emergency Shower
- Flush Rim Sink
- Floor Drain
- Water Bottle Refill Station

Other:

**MED / NON-MED GASES** (Quantity)

Oxygen:	Medical Air:	Medical Vacuum:	Nitrous Oxide:	CO2:	AGSS:	Nitrogen:	Laboratory Air:	Laboratory Vacuum:	Utility Compressed Air:
<input type="text"/>	<input type="text"/>	<input type="text"/>	<input type="text"/>	<input type="text"/>	<input type="text"/>	<input type="text"/>	<input type="text"/>	<input type="text"/>	<input type="text"/>

Gas Remarks:



**Appendix 1B Minimum Room Requirements**

Room Name:

Program Number(s):

1. E1.01.05	7.	13.	19.	25.	31.	37.	43.
2.	8.	14.	20.	26.	32.	38.	44.
3.	9.	15.	21.	27.	33.	39.	45.
4.	10.	16.	22.	28.	34.	40.	46.
5.	11.	17.	23.	29.	35.	41.	47.
6.	12.	18.	24.	30.	36.	42.	48.

**ARCHITECTURAL REQUIREMENTS**

<b>WALL AND CEILING</b> Wall Material: <input type="text" value="ARGB 1.2m AFF, GB above"/> Finish: <input type="text" value="PT"/> Ceiling Material: <input type="text" value="ACT-C"/> Finish: <input type="text" value="PF"/>		<b>WALL PROTECTION</b> Type: <input type="text" value="FRP"/> <input type="checkbox"/> Corner Guards <input type="checkbox"/> Hand Rails <input type="checkbox"/> Bed Bumper / Locator Height: <input type="text" value="2185 mm"/> <input type="checkbox"/> Crash Rails <input type="checkbox"/> Chair Rail			<b>GLAZING</b> <input type="checkbox"/> Interior Glazing		<b>FLOORING TYPES</b> Material: <input type="text" value="VSF"/> Base: <input type="text" value="FCB"/>		<b>ROOM ACCESSORIES</b> <input checked="" type="checkbox"/> Coat Hooks <input type="checkbox"/> Ceiling Lift <input checked="" type="checkbox"/> Magnetic Whiteboard <input type="checkbox"/> Mirror <input type="checkbox"/> Infant Change Table <input type="checkbox"/> Privacy Curtain		
--	--	--	--	--	---	--	--	--	--	--	--

- LEGEND:**
- WALL AND CEILING LEGEND:**
- AC Architectural Ceiling
  - ACT Acoustic Ceiling Tile
  - ACT-C Cleanroom
  - ARGB Abuse-Resistant Gypsum Board
  - GB Gypsum Board
  - IRGB Impact-Resistant Gypsum Board
  - KLCT Kitchen Lay-in Ceiling Tile
  - MMRGB Moisture and Mould-Resistant Gypsum Board
  - SACT Security Acoustic Ceiling Tile
- WALL FINISHES LEGEND:**
- EWC Epoxy Wall Coating
  - HPC High Performance Coating
  - PT Paint
- CEILING FINISHES LEGEND:**
- ECC Epoxy Ceiling Coating
  - HPC High Performance Coating
  - PF Prefinished
  - PT Paint
- WALL PROTECTION LEGEND:**
- ESRP Extruded Semi-Rigid PVCu Panel
  - FRL Fibre Reinforced Laminate
  - FRP Fibreglass Reinforced Plastic
  - PVV Protective Vinyl Wallcovering
  - RHIS Rigid High Impact Sheet
  - WSSP Wetwall Solid Surface Panel
  - WVV Wetroom Vinyl Wallcovering
- FLOOR FINISHES LEGEND:**
- CFS Concrete Floor Sealer
  - EFC Epoxy Floor Coating
  - PFC Polyurethane Floor Coating
  - RAF Rubber Athletic Flooring
  - RSF Rubber Sheet Flooring
  - SCF Seamless Cushioned Flooring
  - SDRF Static-Dissipative Rubber Sheet Flooring
  - SDVF Static-Dissipative Vinyl Sheet Flooring
  - VSF Vinyl Sheet Flooring
  - WSVF Wetroom Safety Vinyl Sheet Flooring
- FLOOR BASE LEGEND:**
- FCB Flash Cove Base
  - RB Rubber Base
  - SCF Seamless Cushioned Flooring

**DOORS**

Types:

Type:Qty:	Size (mm):	Material:	Finish:	Side Lt:	Blinds:	Protect.:	Privacy Film:	Function:	Card Reader:	Mag Lock:	Auto Opener:	Hold Open:	Hinges:	Accessory 1:	Accessory 2:	Accessory 3:	Closer:

Door Remarks:  Security Grille  Anti-barricade strategy

**MILLWORK AND SPECIALTY CASEWORK**

Storage Requirements:

**UPPER UNITS** U1 U2 U3 U4 U5 U6 U7 U8

**LOWER UNITS** L10 L11 L12

**RECEPTION/TRANSACTION COUNTER / CARE TEAM STATION DESK** TC1 TC2

**UTILITY SINK AND COUNTER UNIT** UC1

**SHELF** S1

**FULL-HEIGHT CABINETS** C1 C2 C3 C4 C5

Category	Min. Length (mm)	Motorized Adjustable Height	Standing Height	Specialty Casework
2	1200	<input checked="" type="checkbox"/>	<input checked="" type="checkbox"/>	<input checked="" type="checkbox"/>

**FINISHES**

Full-height Cabinet:

Upper Millwork:

Countertop:

Lower Millwork:

Shelf:

Remarks: Refer to Schedule 1, Section 6.12 (Division 12) for Specialty Casework. Items indicated are diagrammatic, provide specialty casework appropriate for the specific and specialized functions to be performed in the space and to accommodate Equipment. Provide 2 wkstns.

**MECHANICAL REQUIREMENTS**

<b>PLUMBING</b> (Quantity) Hand Hygiene Sink: <input type="text"/> Lavatory: <input type="text"/> Kitchen Sink: <input type="text"/> Seamless Kitchen Sink: <input type="text"/> Utility / Process Sink: <input type="text"/> Scrub Sink: <input type="text"/> Floor Sink: <input type="text"/>							Other Fixtures: <input type="checkbox"/> Shower <input type="checkbox"/> Tub <input type="checkbox"/> Ice Maker <input type="checkbox"/> Water Closet <input type="checkbox"/> Instantaneous Hot Water				<input type="checkbox"/> Eyewash Station <input type="checkbox"/> Eyewash/Shower Station <input type="checkbox"/> Emergency Shower <input type="checkbox"/> Flush Rim Sink <input type="checkbox"/> Floor Drain <input type="checkbox"/> Water Bottle Refill Station				<b>MED / NON-MED GASES</b> (Quantity) Oxygen: <input type="text"/> Medical Air: <input type="text"/> Medical Vacuum: <input type="text"/> Nitrous Oxide: <input type="text"/> CO2: <input type="text"/> AGSS: <input type="text"/> Nitrogen: <input type="text"/> Laboratory Air: <input type="text"/> Laboratory Vacuum: <input type="text"/> Utility Compressed Air: <input type="text"/>				
Plumbing Remarks: <input type="text"/>							Gas Remarks: <input type="text"/>												

**Appendix 1B Minimum Room Requirements**

Room Name:

Program Number(s):

1.	E4.02	7.		13.		19.		25.		31.		37.		43.
2.		8.		14.		20.		26.		32.		38.		44.
3.		9.		15.		21.		27.		33.		39.		45.
4.		10.		16.		22.		28.		34.		40.		46.
5.		11.		17.		23.		29.		35.		41.		47.
6.		12.		18.		24.		30.		36.		42.		48.

**ARCHITECTURAL REQUIREMENTS**

<b>WALL AND CEILING</b> Wall Material: <input type="text" value="ARGB 1.2m AFF, GB above"/> Finish: <input type="text" value="EWC"/> Ceiling Material: <input type="text" value="ACT-C"/> Finish: <input type="text" value="PF"/>	<b>WALL PROTECTION</b> Type: <input type="text" value="FRP"/> <input type="checkbox"/> Corner Guards <input type="checkbox"/> Hand Rails <input type="checkbox"/> Bed Bumper / Locator Height: <input type="text" value="2185 mm"/> <input type="checkbox"/> Crash Rails <input type="checkbox"/> Chair Rail	<b>GLAZING</b> <input type="checkbox"/> Interior Glazing	<b>FLOORING TYPES</b> Material: <input type="text" value="VSF"/> Base: <input type="text" value="FCB"/>	<b>ROOM ACCESSORIES</b> <input checked="" type="checkbox"/> Coat Hooks <input type="checkbox"/> Ceiling Lift <input type="checkbox"/> Magnetic Whiteboard <input type="checkbox"/> Mirror <input type="checkbox"/> Infant Change Table <input type="checkbox"/> Privacy Curtain
---	--	---	--	---

- LEGEND:**
- WALL AND CEILING LEGEND:**
- AC Architectural Ceiling
  - ACT Acoustic Ceiling Tile
  - ACT-C Cleanroom
  - ARGB Abuse-Resistant Gypsum Board
  - GB Gypsum Board
  - IRGB Impact-Resistant Gypsum Board
  - KLCT Kitchen Lay-in Ceiling Tile
  - MMRGB Moisture and Mould-Resistant Gypsum Board
  - SACT Security Acoustic Ceiling Tile
- WALL FINISHES LEGEND:**
- EWC Epoxy Wall Coating
  - HPC High Performance Coating
  - PT Paint
- CEILING FINISHES LEGEND:**
- ECC Epoxy Ceiling Coating
  - HPC High Performance Coating
  - PF Prefinished
  - PT Paint
- WALL PROTECTION LEGEND:**
- ESRP Extruded Semi-Rigid PVCu Panel
  - FRL Fibre Reinforced Laminate
  - FRP Fibreglass Reinforced Plastic
  - PVV Protective Vinyl Wallcovering
  - RHIS Rigid High Impact Sheet
  - WSSP Wetwall Solid Surface Panel
  - WVV Wetroom Vinyl Wallcovering
- FLOOR FINISHES LEGEND:**
- CFS Concrete Floor Sealer
  - EFC Epoxy Floor Coating
  - PFC Polyurethane Floor Coating
  - RAF Rubber Athletic Flooring
  - RSF Rubber Sheet Flooring
  - SCF Seamless Cushioned Flooring
  - SDRF Static-Dissipative Rubber Sheet Flooring
  - SDVF Static-Dissipative Vinyl Sheet Flooring
  - VSF Vinyl Sheet Flooring
  - WSVF Wetroom Safety Vinyl Sheet Flooring
- FLOOR BASE LEGEND:**
- FCB Flash Cove Base
  - RB Rubber Base
  - SCF Seamless Cushioned Flooring

**DOORS**

Types:

Type	Qty	Size (mm)	Material	Finish	Side Lt.	Blinds	Protect.	Privacy Film	Function	Card Reader	Mag Lock	Auto Opener	Hold Open	Hinges	Accessory 1	Accessory 2	Accessory 3	Closer
C2	1	1830 x 2135	Solid Core	FRL	<input type="checkbox"/>	<input type="checkbox"/>	2 High	<input checked="" type="checkbox"/>	Storeroom	<input checked="" type="checkbox"/>	<input type="checkbox"/>	<input checked="" type="checkbox"/>	<input type="checkbox"/>	Cont. Swing Clear	Astragal	Flush Bolt	Elec. Strike	Surface

Door Remarks:  Security Grille  Anti-barricade strategy



**MECHANICAL REQUIREMENTS**

<b>PLUMBING</b> (Quantity) Hand Hygiene Sink: <input type="text"/> Lavatory: <input type="text"/> Kitchen Sink: <input type="text"/> Seamless Kitchen Sink: <input type="text"/> Utility / Process Sink: <input type="text"/> Scrub Sink: <input type="text"/> Floor Sink: <input type="text"/> Plumbing Remarks: <input type="text"/>	Other Fixtures: <input type="checkbox"/> Shower <input type="checkbox"/> Eyewash Station <input type="checkbox"/> Tub <input type="checkbox"/> Eyewash/Shower Station <input type="checkbox"/> Ice Maker <input type="checkbox"/> Emergency Shower <input type="checkbox"/> Water Closet <input type="checkbox"/> Flush Rim Sink <input type="checkbox"/> Instantaneous Hot Water <input type="checkbox"/> Floor Drain <input type="checkbox"/> <input type="checkbox"/> Water Bottle Refill Station Other <input type="text"/>	<b>MED / NON-MED GASES</b> (Quantity) Oxygen: <input type="text"/> Medical Air: <input type="text"/> Medical Vacuum: <input type="text"/> Nitrous Oxide: <input type="text"/> CO2: <input type="text"/> AGSS: <input type="text"/> Nitrogen: <input type="text"/> Laboratory Air: <input type="text"/> Laboratory Vacuum: <input type="text"/> Utility Compressed Air: <input type="text"/> Gas Remarks: <input type="text"/>
---	--	---

**Appendix 1B Minimum Room Requirements**

Room Name:

Program Number(s):

1. E2.02	7.	13.	19.	25.	31.	37.	43.
2.	8.	14.	20.	26.	32.	38.	44.
3.	9.	15.	21.	27.	33.	39.	45.
4.	10.	16.	22.	28.	34.	40.	46.
5.	11.	17.	23.	29.	35.	41.	47.
6.	12.	18.	24.	30.	36.	42.	48.

**ARCHITECTURAL REQUIREMENTS**

<b>WALL AND CEILING</b> Wall Material: <input type="text" value="ARGB 1.2m AFF, GB above"/> Finish: <input type="text" value="EWC"/> Ceiling Material: <input type="text" value="ACT-C"/> Finish: <input type="text" value="PF"/>	<b>WALL PROTECTION</b> Type: <input type="text" value="FRP"/> <input type="checkbox"/> Corner Guards <input type="checkbox"/> Hand Rails <input type="checkbox"/> Bed Bumper / Locator Height: <input type="text" value="2185 mm"/> <input type="checkbox"/> Crash Rails <input type="checkbox"/> Chair Rail	<b>GLAZING</b> <input type="checkbox"/> Interior Glazing	<b>FLOORING TYPES</b> Material: <input type="text" value="VSF"/> Base: <input type="text" value="FCB"/>	<b>ROOM ACCESSORIES</b> <input checked="" type="checkbox"/> Coat Hooks <input type="checkbox"/> Ceiling Lift <input type="checkbox"/> Magnetic Whiteboard <input type="checkbox"/> Mirror <input type="checkbox"/> Infant Change Table <input type="checkbox"/> Privacy Curtain
---	--	---	--	---

- LEGEND:**
- WALL AND CEILING LEGEND:**
- AC Architectural Ceiling
  - ACT Acoustic Ceiling Tile
  - ACT-C Cleanroom
  - ARGB Abuse-Resistant Gypsum Board
  - GB Gypsum Board
  - IRGB Impact-Resistant Gypsum Board
  - KLCT Kitchen Lay-in Ceiling Tile
  - MMRGB Moisture and Mould-Resistant Gypsum Board
  - SACT Security Acoustic Ceiling Tile
- WALL FINISHES LEGEND:**
- EWC Epoxy Wall Coating
  - HPC High Performance Coating
  - PT Paint
- CEILING FINISHES LEGEND:**
- ECC Epoxy Ceiling Coating
  - HPC High Performance Coating
  - PF Prefinished
  - PT Paint
- WALL PROTECTION LEGEND:**
- ESRP Extruded Semi-Rigid PVCu Panel
  - FRL Fibre Reinforced Laminat
  - FRP Fibreglass Reinforced Plastic
  - PVV Protective Vinyl Wallcovering
  - RHIS Rigid High Impact Sheet
  - WSSP Wetwall Solid Surface Panel
  - WVV Wetroom Vinyl Wallcovering
- FLOOR FINISHES LEGEND:**
- CFS Concrete Floor Sealer
  - EFC Epoxy Floor Coating
  - PFC Polyurethane Floor Coating
  - RAF Rubber Athletic Flooring
  - RSF Rubber Sheet Flooring
  - SCF Seamless Cushioned Flooring
  - SDRF Static-Dissipative Rubber Sheet Flooring
  - SDVF Static-Dissipative Vinyl Sheet Flooring
  - VSF Vinyl Sheet Flooring
  - WSVF Wetroom Safety Vinyl Sheet Flooring
- FLOOR BASE LEGEND:**
- FCB Flash Cove Base
  - RB Rubber Base
  - SCF Seamless Cushioned Flooring

**DOORS**

Types:

Type	Qty	Size (mm)	Material	Finish	Side Lt.	Blinds	Protect.	Privacy Film	Function	Card Reader	Mag Lock	Auto Opener	Hold Open	Hinges	Accessory 1	Accessory 2	Accessory 3	Closer
C2	1	1830 x 2135	Solid Core	FRL	<input type="checkbox"/>	<input type="checkbox"/>	2 High	<input checked="" type="checkbox"/>	Storeroom	<input checked="" type="checkbox"/>	<input type="checkbox"/>	<input checked="" type="checkbox"/>	<input type="checkbox"/>	Cont. Swing Clear	Astragal	Flush Bolt	Elec. Strike	Surface

Door Remarks:  Security Grille  Anti-barricade strategy

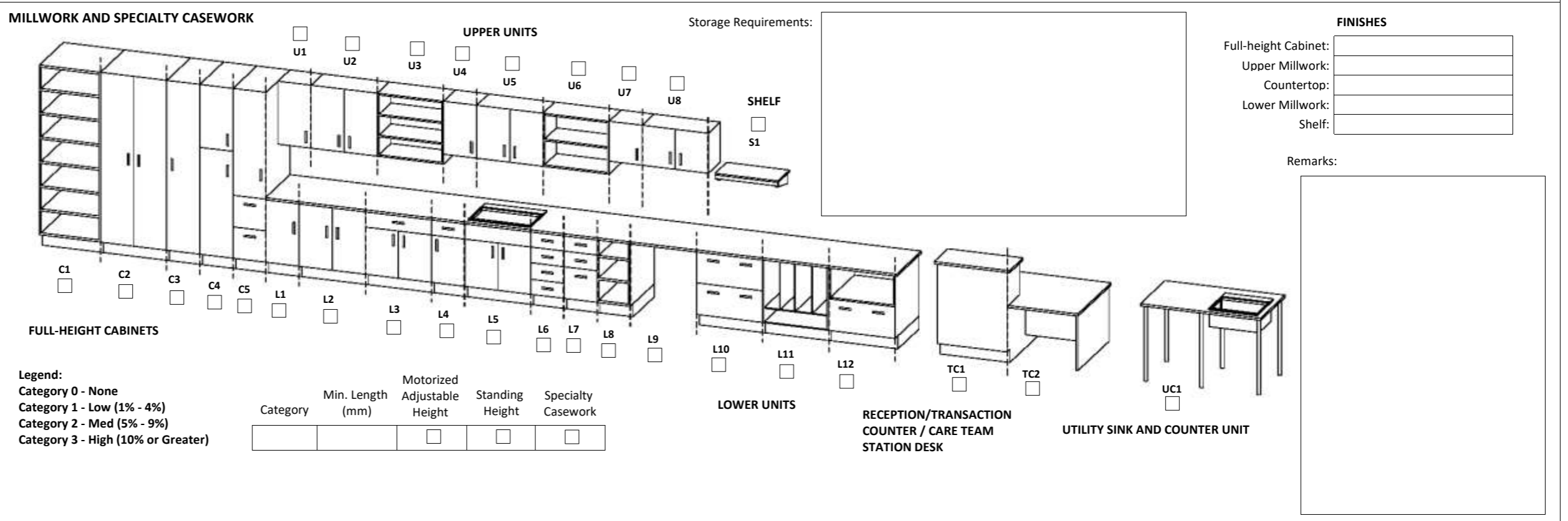

**MECHANICAL REQUIREMENTS**

<b>PLUMBING</b> (Quantity) Hand Hygiene Sink: <input type="text"/> Lavatory: <input type="text"/> Kitchen Sink: <input type="text"/> Seamless Kitchen Sink: <input type="text"/> Utility / Process Sink: <input type="text"/> Scrub Sink: <input type="text"/> Floor Sink: <input type="text"/> Plumbing Remarks: <input type="text"/>	Other Fixtures: <input type="checkbox"/> Shower <input type="checkbox"/> Eyewash Station <input type="checkbox"/> Tub <input type="checkbox"/> Eyewash/Shower Station <input type="checkbox"/> Ice Maker <input type="checkbox"/> Emergency Shower <input type="checkbox"/> Water Closet <input type="checkbox"/> Flush Rim Sink <input type="checkbox"/> Instantaneous Hot Water <input type="checkbox"/> Floor Drain <input type="checkbox"/> <input type="checkbox"/> Water Bottle Refill Station Other <input type="text"/>	<b>MED / NON-MED GASES</b> (Quantity) Oxygen: <input type="text"/> Medical Air: <input type="text"/> Medical Vacuum: <input type="text"/> Nitrous Oxide: <input type="text"/> CO2: <input type="text"/> AGSS: <input type="text"/> Nitrogen: <input type="text"/> Laboratory Air: <input type="text"/> Laboratory Vacuum: <input type="text"/> Utility Compressed Air: <input type="text"/> Gas Remarks: <input type="text"/>
---	--	---



**Appendix 1B Minimum Room Requirements**

Room Name:

Program Number(s):

1.	E1.02	7.		13.		19.		25.		31.		37.		43.
2.		8.		14.		20.		26.		32.		38.		44.
3.		9.		15.		21.		27.		33.		39.		45.
4.		10.		16.		22.		28.		34.		40.		46.
5.		11.		17.		23.		29.		35.		41.		47.
6.		12.		18.		24.		30.		36.		42.		48.

**ARCHITECTURAL REQUIREMENTS**

<b>WALL AND CEILING</b> Wall Material: <input type="text" value="ARGB 1.2m AFF, GB above"/> Finish: <input type="text" value="EWC"/> Ceiling Material: <input type="text" value="ACT-C"/> Finish: <input type="text" value="PF"/>		<b>WALL PROTECTION</b> Type: <input type="text" value="PVW"/> <input type="checkbox"/> Corner Guards <input type="checkbox"/> Hand Rails <input type="checkbox"/> Bed Bumper / Locator Height: <input type="text" value="2185 mm"/> <input checked="" type="checkbox"/> Crash Rails <input type="checkbox"/> Chair Rail			<b>GLAZING</b> <input type="checkbox"/> Interior Glazing		<b>FLOORING TYPES</b> Material: <input type="text" value="VSF"/> Base: <input type="text" value="FCB"/>		<b>ROOM ACCESSORIES</b> <input checked="" type="checkbox"/> Coat Hooks <input type="checkbox"/> Ceiling Lift <input type="checkbox"/> Magnetic Whiteboard <input type="checkbox"/> Mirror <input type="checkbox"/> Infant Change Table <input type="checkbox"/> Privacy Curtain		
---	--	---	--	--	---	--	--	--	---	--	--

- LEGEND:**
- WALL AND CEILING LEGEND:**
- AC Architectural Ceiling
  - ACT Acoustic Ceiling Tile
  - ACT-C Cleanroom
  - ARGB Abuse-Resistant Gypsum Board
  - GB Gypsum Board
  - IRGB Impact-Resistant Gypsum Board
  - KLCT Kitchen Lay-in Ceiling Tile
  - MMRGB Moisture and Mould-Resistant Gypsum Board
  - SACT Security Acoustic Ceiling Tile
- WALL FINISHES LEGEND:**
- EWC Epoxy Wall Coating
  - HPC High Performance Coating
  - PT Paint
- CEILING FINISHES LEGEND:**
- ECC Epoxy Ceiling Coating
  - HPC High Performance Coating
  - PF Prefinished
  - PT Paint
- WALL PROTECTION LEGEND:**
- ESRP Extruded Semi-Rigid PVCu Panel
  - FRL Fibre Reinforced Laminate
  - FRP Fibreglass Reinforced Plastic
  - PVW Protective Vinyl Wallcovering
  - RHIS Rigid High Impact Sheet
  - WSSP Wetwall Solid Surface Panel
  - WVV Wetroom Vinyl Wallcovering
- FLOOR FINISHES LEGEND:**
- CFS Concrete Floor Sealer
  - EFC Epoxy Floor Coating
  - PFC Polyurethane Floor Coating
  - RAF Rubber Athletic Flooring
  - RSF Rubber Sheet Flooring
  - SCF Seamless Cushioned Flooring
  - SDRF Static-Dissipative Rubber Sheet Flooring
  - SDVF Static-Dissipative Vinyl Sheet Flooring
  - VSF Vinyl Sheet Flooring
  - WSVF Wetroom Safety Vinyl Sheet Flooring
- FLOOR BASE LEGEND:**
- FCB Flash Cove Base
  - RB Rubber Base
  - SCF Seamless Cushioned Flooring

**DOORS**

Types:

Type	Qty	Size (mm)	Material	Finish	Side Lt.	Blinds	Protect.	Privacy Film	Function	Card Reader	Mag Lock	Auto Opener	Hold Open	Hinges	Accessory 1	Accessory 2	Accessory 3	Closer
C	2	1220 x 2135	Solid Core	FRL	<input type="checkbox"/>	<input type="checkbox"/>	2 High	<input checked="" type="checkbox"/>	Classroom	<input type="checkbox"/>	<input type="checkbox"/>	<input type="checkbox"/>	<input type="checkbox"/>	Cont. Swing Clear				

Door Remarks:  Security Grille  Anti-barricade strategy

**MILLWORK AND SPECIALTY CASEWORK**

Storage Requirements:

**UPPER UNITS** (U1-U8) **SHELF** (S1)

**LOWER UNITS** (L1-L12) **RECEPTION/TRANSACTION COUNTER / CARE TEAM STATION DESK** (TC1, TC2) **UTILITY SINK AND COUNTER UNIT** (UC1)

**FULL-HEIGHT CABINETS** (C1-C5)

Category	Min. Length (mm)	Motorized Adjustable Height	Standing Height	Specialty Casework
3	1800	<input type="checkbox"/>	<input type="checkbox"/>	<input checked="" type="checkbox"/>

**FINISHES**

Full-height Cabinet:   
 Upper Millwork:   
 Countertop:   
 Lower Millwork:   
 Shelf:

Remarks: Refer to Schedule 1, Section 6.12 (Division 12) for Specialty Casework. Items indicated are diagrammatic, provide specialty casework appropriate for the specific and specialized functions to be performed in the space and to accommodate Equipment. Provide open shelving at 1.1 m above finished floor level for supplies and space below for phlebotomy cart storage.

**MECHANICAL REQUIREMENTS**

<b>PLUMBING</b> (Quantity) Hand Hygiene Sink: <input type="text"/> Lavatory: <input type="text"/> Kitchen Sink: <input type="text"/> Seamless Kitchen Sink: <input type="text"/> Utility / Process Sink: <input type="text"/> Scrub Sink: <input type="text"/> Floor Sink: <input type="text"/>							Other Fixtures: <input type="checkbox"/> Shower <input type="checkbox"/> Eyewash Station <input type="checkbox"/> Tub <input type="checkbox"/> Eyewash/Shower Station <input type="checkbox"/> Ice Maker <input type="checkbox"/> Emergency Shower <input type="checkbox"/> Water Closet <input type="checkbox"/> Flush Rim Sink <input type="checkbox"/> Instantaneous Hot Water <input type="checkbox"/> Floor Drain <input type="checkbox"/> Water Bottle Refill Station Other: <input type="text"/>				<b>MED / NON-MED GASES</b> (Quantity) Oxygen: <input type="text"/> Medical Air: <input type="text"/> Medical Vacuum: <input type="text"/> Nitrous Oxide: <input type="text"/> CO2: <input type="text"/> AGSS: <input type="text"/> Nitrogen: <input type="text"/> Laboratory Air: <input type="text"/> Laboratory Vacuum: <input type="text"/> Utility Compressed Air: <input type="text"/>					
Plumbing Remarks: <input type="text"/>											Gas Remarks: <input type="text"/>					

**Appendix 1B Minimum Room Requirements**

Room Name:

Program Number(s):

1. E3.01.12	7.	13.	19.	25.	31.	37.	43.
2.	8.	14.	20.	26.	32.	38.	44.
3.	9.	15.	21.	27.	33.	39.	45.
4.	10.	16.	22.	28.	34.	40.	46.
5.	11.	17.	23.	29.	35.	41.	47.
6.	12.	18.	24.	30.	36.	42.	48.

**ARCHITECTURAL REQUIREMENTS**

<b>WALL AND CEILING</b> Wall Material: <input type="text" value="ARGB 1.2m AFF, GB above"/> Finish: <input type="text" value="EWC"/> Ceiling Material: <input type="text" value="ACT-C"/> Finish: <input type="text" value="PF"/>	<b>WALL PROTECTION</b> Type: <input type="text" value="FRP"/> <input type="checkbox"/> Corner Guards <input type="checkbox"/> Hand Rails <input type="checkbox"/> Bed Bumper / Locator Height: <input type="text" value="2185 mm"/> <input type="checkbox"/> Crash Rails <input type="checkbox"/> Chair Rail	<b>GLAZING</b> <input type="checkbox"/> Interior Glazing	<b>FLOORING TYPES</b> Material: <input type="text" value="VSF"/> Base: <input type="text" value="FCB"/>	<b>ROOM ACCESSORIES</b> <input type="checkbox"/> Coat Hooks <input type="checkbox"/> Ceiling Lift <input type="checkbox"/> Magnetic Whiteboard <input type="checkbox"/> Mirror <input type="checkbox"/> Infant Change Table <input type="checkbox"/> Privacy Curtain
---	--	---	--	--

- LEGEND:**
- WALL AND CEILING LEGEND:**
- AC Architectural Ceiling
  - ACT Acoustic Ceiling Tile
  - ACT-C Cleanroom
  - ARGB Abuse-Resistant Gypsum Board
  - GB Gypsum Board
  - IRGB Impact-Resistant Gypsum Board
  - KLCT Kitchen Lay-in Ceiling Tile
  - MMRGB Moisture and Mould-Resistant Gypsum Board
  - SACT Security Acoustic Ceiling Tile
- WALL FINISHES LEGEND:**
- EWC Epoxy Wall Coating
  - HPC High Performance Coating
  - PT Paint
- CEILING FINISHES LEGEND:**
- ECC Epoxy Ceiling Coating
  - HPC High Performance Coating
  - PF Prefinished
  - PT Paint
- WALL PROTECTION LEGEND:**
- ESRP Extruded Semi-Rigid PVCu Panel
  - FRL Fibre Reinforced Laminate
  - FRP Fibreglass Reinforced Plastic
  - PVV Protective Vinyl Wallcovering
  - RHIS Rigid High Impact Sheet
  - WSSP Wetwall Solid Surface Panel
  - WWW Wetroom Vinyl Wallcovering
- FLOOR FINISHES LEGEND:**
- CFS Concrete Floor Sealer
  - EFC Epoxy Floor Coating
  - PFC Polyurethane Floor Coating
  - RAF Rubber Athletic Flooring
  - RSF Rubber Sheet Flooring
  - SCF Seamless Cushioned Flooring
  - SDRF Static-Dissipative Rubber Sheet Flooring
  - SDVF Static-Dissipative Vinyl Sheet Flooring
  - VSF Vinyl Sheet Flooring
  - WSVF Wetroom Safety Vinyl Sheet Flooring
- FLOOR BASE LEGEND:**
- FCB Flash Cove Base
  - RB Rubber Base
  - SCF Seamless Cushioned Flooring

**DOORS**

Types:

Type	Qty	Size (mm)	Material	Finish	Side Lt.	Blinds	Protect.	Privacy Film	Function	Card Reader	Mag Lock	Auto Opener	Hold Open	Hinges	Accessory 1	Accessory 2	Accessory 3	Closer

Door Remarks:  Security Grille  Anti-barricade strategy

**MILLWORK AND SPECIALTY CASEWORK**

Storage Requirements:

**UPPER UNITS** U1 U2 U3 U4 U5 U6 U7 U8

**LOWER UNITS** L10 L11 L12

**RECEPTION/TRANSACTION COUNTER / CARE TEAM STATION DESK** TC1 TC2

**UTILITY SINK AND COUNTER UNIT** UC1

**FULL-HEIGHT CABINETS** C1 C2 C3 C4 C5

**Legend:**

Category	Min. Length (mm)	Motorized Adjustable Height	Standing Height	Specialty Casework
Category 0 - None				
Category 1 - Low (1% - 4%)				
Category 2 - Med (5% - 9%)				
Category 3 - High (10% or Greater)				
3	1800	<input checked="" type="checkbox"/>	<input checked="" type="checkbox"/>	<input checked="" type="checkbox"/>

**FINISHES**

Full-height Cabinet:   
 Upper Millwork:   
 Countertop:   
 Lower Millwork:   
 Shelf:

Remarks: Refer to Schedule 1, Section 6.12 (Division 12) for Specialty Casework. Items indicated are diagrammatic, provide specialty casework appropriate for the specific and specialized functions to be performed in the space and to accommodate Equipment. Provide LIS wkstn.

**MECHANICAL REQUIREMENTS**

<b>PLUMBING</b> (Quantity) Hand Hygiene Sink: <input type="text"/> Lavatory: <input type="text"/> Kitchen Sink: <input type="text"/> Seamless Kitchen Sink: <input type="text"/> Utility / Process Sink: <input type="text"/> Scrub Sink: <input type="text"/> Floor Sink: <input type="text"/> Plumbing Remarks: <input type="text"/>	Other Fixtures: <input type="checkbox"/> Shower <input type="checkbox"/> Tub <input type="checkbox"/> Ice Maker <input type="checkbox"/> Water Closet <input type="checkbox"/> Instantaneous Hot Water <input type="checkbox"/> Ewwash Station <input type="checkbox"/> Ewwash/Shower Station <input type="checkbox"/> Emergency Shower <input type="checkbox"/> Flush Rim Sink <input type="checkbox"/> Floor Drain <input type="checkbox"/> Water Bottle Refill Station Other <input type="text"/>	<b>MED / NON-MED GASES</b> (Quantity) Oxygen: <input type="text"/> Medical Air: <input type="text"/> Medical Vacuum: <input type="text"/> Nitrous Oxide: <input type="text"/> CO2: <input type="text"/> AGSS: <input type="text"/> Nitrogen: <input type="text"/> Laboratory Air: <input type="text"/> Laboratory Vacuum: <input type="text"/> Utility Compressed Air: <input type="text"/> Gas Remarks: <input type="text"/>
---	---	---

# Appendix 1B Minimum Room Requirements

Room Name:

Program Number(s):

1. E2.06	7.	13.	19.	25.	31.	37.	43.
2.	8.	14.	20.	26.	32.	38.	44.
3.	9.	15.	21.	27.	33.	39.	45.
4.	10.	16.	22.	28.	34.	40.	46.
5.	11.	17.	23.	29.	35.	41.	47.
6.	12.	18.	24.	30.	36.	42.	48.

## ARCHITECTURAL REQUIREMENTS

<b>WALL AND CEILING</b> Wall Material: <input type="text" value="ARGB 1.2m AFF, GB above"/> Finish: <input type="text" value="EWC"/> Ceiling Material: <input type="text" value="ACT-C"/> Finish: <input type="text" value="PF"/>	<b>WALL PROTECTION</b> Type: <input type="text" value="FRP"/> <input checked="" type="checkbox"/> Corner Guards <input type="checkbox"/> Hand Rails <input type="checkbox"/> Bed Bumper / Locator Height: <input type="text" value="2185 mm"/> <input checked="" type="checkbox"/> Crash Rails <input type="checkbox"/> Chair Rail	<b>GLAZING</b> <input type="checkbox"/> Interior Glazing	<b>FLOORING TYPES</b> Material: <input type="text" value="VSF"/> Base: <input type="text" value="FCB"/>	<b>ROOM ACCESSORIES</b> <input type="checkbox"/> Coat Hooks <input type="checkbox"/> Ceiling Lift <input type="checkbox"/> Magnetic Whiteboard <input type="checkbox"/> Mirror <input type="checkbox"/> Infant Change Table <input type="checkbox"/> Privacy Curtain
---	--	---	--	--

- LEGEND:**
- WALL AND CEILING LEGEND:**
- AC Architectural Ceiling
  - ACT Acoustic Ceiling Tile
  - ACT-C Cleanroom
  - ARGB Abuse-Resistant Gypsum Board
  - GB Gypsum Board
  - IRGB Impact-Resistant Gypsum Board
  - KLCT Kitchen Lay-in Ceiling Tile
  - MMRGB Moisture and Mould-Resistant Gypsum Board
  - SACT Security Acoustic Ceiling Tile
- WALL FINISHES LEGEND:**
- EWC Epoxy Wall Coating
  - HPC High Performance Coating
  - PT Paint
- CEILING FINISHES LEGEND:**
- ECC Epoxy Ceiling Coating
  - HPC High Performance Coating
  - PF Prefinished
  - PT Paint
- WALL PROTECTION LEGEND:**
- ESRP Extruded Semi-Rigid PVCu Panel
  - FRL Fibre Reinforced Laminata
  - FRP Fibreglass Reinforced Plastic
  - PVV Protective Vinyl Wallcovering
  - RHIS Rigid High Impact Sheet
  - WSSP Wetwall Solid Surface Panel
  - WVV Wetroom Vinyl Wallcovering
- FLOOR FINISHES LEGEND:**
- CFS Concrete Floor Sealer
  - EFC Epoxy Floor Coating
  - PFC Polyurethane Floor Coating
  - RAF Rubber Athletic Flooring
  - RSF Rubber Sheet Flooring
  - SCF Seamless Cushioned Flooring
  - SDRF Static-Dissipative Rubber Sheet Flooring
  - SDVF Static-Dissipative Vinyl Sheet Flooring
  - VSF Vinyl Sheet Flooring
  - WSVF Wetroom Safety Vinyl Sheet Flooring
- FLOOR BASE LEGEND:**
- FCB Flash Cove Base
  - RB Rubber Base
  - SCF Seamless Cushioned Flooring

**DOORS**

Types:

Type	Qty	Size (mm)	Material	Finish	Side Lt.	Blinds	Protect.	Privacy Film	Function	Card Reader	Mag Lock	Auto Opener	Hold Open	Hinges	Accessory 1	Accessory 2	Accessory 3	Closer
C	1	1220 x 2135	Solid Core	FRL	<input type="checkbox"/>	<input type="checkbox"/>	2 High	<input type="checkbox"/>	Storeroom	<input checked="" type="checkbox"/>	<input type="checkbox"/>	<input type="checkbox"/>	<input type="checkbox"/>	Cont. Swing Clear	Astragal	Flush Bolt		Surface

Door Remarks:  Security Grille  Anti-barricade strategy

**MILLWORK AND SPECIALTY CASEWORK**

Storage Requirements:

**UPPER UNITS** (U1-U8) **SHELF** (S1)

**FULL-HEIGHT CABINETS** (C1-C5) **LOWER UNITS** (L1-L12) **RECEPTION/TRANSACTION COUNTER / CARE TEAM STATION DESK** (TC1-TC2) **UTILITY SINK AND COUNTER UNIT** (UC1)

Category	Min. Length (mm)	Motorized Adjustable Height	Standing Height	Specialty Casework
2	2400	<input type="checkbox"/>	<input type="checkbox"/>	<input checked="" type="checkbox"/>

**FINISHES**

Full-height Cabinet:   
 Upper Millwork:   
 Countertop:   
 Lower Millwork:   
 Shelf:

Remarks: Refer to Schedule 1, Section 6.12 (Division 12) for Specialty Casework. Items indicated are diagrammatic, provide specialty casework appropriate for the specific and specialized functions to be performed in the space and to accommodate Equipment. Provide LIS wkstn.

## MECHANICAL REQUIREMENTS

<b>PLUMBING</b> (Quantity) Hand Hygiene Sink: <input type="text"/> Lavatory: <input type="text"/> Kitchen Sink: <input type="text"/> Seamless Kitchen Sink: <input type="text"/> Utility / Process Sink: <input type="text"/> Scrub Sink: <input type="text"/> Floor Sink: <input type="text"/> Plumbing Remarks: <input type="text"/>	Other Fixtures: <input type="checkbox"/> Shower <input type="checkbox"/> Eyewash Station <input type="checkbox"/> Tub <input type="checkbox"/> Eyewash/Shower Station <input type="checkbox"/> Ice Maker <input type="checkbox"/> Emergency Shower <input type="checkbox"/> Water Closet <input type="checkbox"/> Flush Rim Sink <input type="checkbox"/> Instantaneous Hot Water <input type="checkbox"/> Floor Drain <input type="checkbox"/> <input type="checkbox"/> Water Bottle Refill Station Other: <input type="text"/>	<b>MED / NON-MED GASES</b> (Quantity) Oxygen: <input type="text"/> Medical Air: <input type="text"/> Medical Vacuum: <input type="text"/> Nitrous Oxide: <input type="text"/> CO2: <input type="text"/> AGSS: <input type="text"/> Nitrogen: <input type="text"/> Laboratory Air: <input type="text"/> Laboratory Vacuum: <input type="text"/> Utility Compressed Air: <input type="text"/> Gas Remarks: <input type="text"/>
---	---	--



# Appendix 1B Minimum Room Requirements

Room Name:

Program Number(s):

1. E5.03	7.	13.	19.	25.	31.	37.	43.
2.	8.	14.	20.	26.	32.	38.	44.
3.	9.	15.	21.	27.	33.	39.	45.
4.	10.	16.	22.	28.	34.	40.	46.
5.	11.	17.	23.	29.	35.	41.	47.
6.	12.	18.	24.	30.	36.	42.	48.

## ARCHITECTURAL REQUIREMENTS

<b>WALL AND CEILING</b> Wall Material: <input type="text"/> Ceiling Material: <input type="text"/> Finish: <input type="text"/> Finish: <input type="text"/>	<b>WALL PROTECTION</b> Type: <input type="text"/> Height: <input type="text"/> <input type="checkbox"/> Corner Guards <input type="checkbox"/> Hand Rails <input type="checkbox"/> Bed Bumper / Locator <input type="checkbox"/> Crash Rails <input type="checkbox"/> Chair Rail	<b>GLAZING</b> <input type="checkbox"/> Interior Glazing	<b>FLOORING TYPES</b> Material: <input type="text"/> Base: <input type="text"/>	<b>ROOM ACCESSORIES</b> <input type="checkbox"/> Coat Hooks <input type="checkbox"/> Ceiling Lift <input type="checkbox"/> Magnetic Whiteboard <input type="checkbox"/> Mirror <input type="checkbox"/> Infant Change Table <input type="checkbox"/> Privacy Curtain
--	--	---	--	--

- LEGEND:**
- WALL AND CEILING LEGEND:**
- AC Architectural Ceiling
  - ACT Acoustic Ceiling Tile
  - ACT-C Cleanroom
  - ARGB Abuse-Resistant Gypsum Board
  - GB Gypsum Board
  - IRGB Impact-Resistant Gypsum Board
  - KLCT Kitchen Lay-in Ceiling Tile
  - MMRGB Moisture and Mould-Resistant Gypsum Board
  - SACT Security Acoustic Ceiling Tile
- WALL FINISHES LEGEND:**
- EWC Epoxy Wall Coating
  - HPC High Performance Coating
  - PT Paint
- CEILING FINISHES LEGEND:**
- ECC Epoxy Ceiling Coating
  - HPC High Performance Coating
  - PF Prefinished
  - PT Paint
- WALL PROTECTION LEGEND:**
- ESRP Extruded Semi-Rigid PVCu Panel
  - FRL Fibre Reinforced Laminate
  - FRP Fibreglass Reinforced Plastic
  - PVV Protective Vinyl Wallcovering
  - RHIS Rigid High Impact Sheet
  - WSSP Wetwall Solid Surface Panel
  - WVV Wetroom Vinyl Wallcovering
- FLOOR FINISHES LEGEND:**
- CFS Concrete Floor Sealer
  - EFC Epoxy Floor Coating
  - PFC Polyurethane Floor Coating
  - RAF Rubber Athletic Flooring
  - RSF Rubber Sheet Flooring
  - SCF Seamless Cushioned Flooring
  - SDRF Static-Dissipative Rubber Sheet Flooring
  - SDVF Static-Dissipative Vinyl Sheet Flooring
  - VSF Vinyl Sheet Flooring
  - WSVF Wetroom Safety Vinyl Sheet Flooring
- FLOOR BASE LEGEND:**
- FCB Flash Cove Base
  - RB Rubber Base
  - SCF Seamless Cushioned Flooring

**DOORS**

Types:

Type:Qty:	Size (mm):	Material:	Finish:	Side Lt:	Blinds:	Protect.:	Privacy Film:	Function:	Card Reader:	Mag Lock:	Auto Opener:	Hold Open:	Hinges:	Accessory 1:	Accessory 2:	Accessory 3:	Closer:

Door Remarks:

Security Grille  
 Anti-barricade strategy

**MILLWORK AND SPECIALTY CASEWORK**

Storage Requirements:

**UPPER UNITS** (U1-U8)   **SHELF** (S1)

**FULL-HEIGHT CABINETS** (C1-C5)   **LOWER UNITS** (L1-L12)

**RECEPTION/TRANSACTION COUNTER / CARE TEAM STATION DESK** (TC1, TC2)

**UTILITY SINK AND COUNTER UNIT** (UC1)

**FINISHES**

Full-height Cabinet:   
 Upper Millwork:   
 Countertop:   
 Lower Millwork:   
 Shelf:

Remarks:

Category	Min. Length (mm)	Motorized Adjustable Height	Standing Height	Specialty Casework

**Legend:**  
 Category 0 - None  
 Category 1 - Low (1% - 4%)  
 Category 2 - Med (5% - 9%)  
 Category 3 - High (10% or Greater)

## MECHANICAL REQUIREMENTS

<p><b>PLUMBING</b> (Quantity)</p> <table border="1" style="width:100%"> <tr> <td>Hand Hygiene Sink:</td> <td>Lavatory:</td> <td>Kitchen Sink:</td> <td>Seamless Kitchen Sink:</td> <td>Utility / Process Sink:</td> <td>Scrub Sink:</td> <td>Floor Sink:</td> </tr> <tr> <td> </td> <td> </td> <td> </td> <td> </td> <td> </td> <td> </td> <td> </td> </tr> </table> <p>Plumbing Remarks: <input type="text"/></p>	Hand Hygiene Sink:	Lavatory:	Kitchen Sink:	Seamless Kitchen Sink:	Utility / Process Sink:	Scrub Sink:	Floor Sink:								<p>Other Fixtures:</p> <input type="checkbox"/> Shower <input type="checkbox"/> Eyewash Station <input type="checkbox"/> Tub <input type="checkbox"/> Eyewash/Shower Station <input type="checkbox"/> Ice Maker <input type="checkbox"/> Emergency Shower <input type="checkbox"/> Water Closet <input type="checkbox"/> Flush Rim Sink <input type="checkbox"/> Instantaneous Hot Water <input type="checkbox"/> Floor Drain <input type="checkbox"/> <input type="checkbox"/> Water Bottle Refill Station Other: <input type="text"/>	<p><b>MED / NON-MED GASES</b> (Quantity)</p> <table border="1" style="width:100%"> <tr> <td>Oxygen:</td> <td>Medical Air:</td> <td>Medical Vacuum:</td> <td>Nitrous Oxide:</td> <td>CO2:</td> <td>AGSS:</td> <td>Nitrogen:</td> <td>Laboratory Air:</td> <td>Laboratory Vacuum:</td> <td>Utility Compressed Air:</td> </tr> <tr> <td> </td> <td> </td> <td> </td> <td> </td> <td> </td> <td> </td> <td> </td> <td> </td> <td> </td> <td> </td> </tr> </table> <p>Gas Remarks: <input type="text"/></p>	Oxygen:	Medical Air:	Medical Vacuum:	Nitrous Oxide:	CO2:	AGSS:	Nitrogen:	Laboratory Air:	Laboratory Vacuum:	Utility Compressed Air:										
Hand Hygiene Sink:	Lavatory:	Kitchen Sink:	Seamless Kitchen Sink:	Utility / Process Sink:	Scrub Sink:	Floor Sink:																														
Oxygen:	Medical Air:	Medical Vacuum:	Nitrous Oxide:	CO2:	AGSS:	Nitrogen:	Laboratory Air:	Laboratory Vacuum:	Utility Compressed Air:																											

**Appendix 1B Minimum Room Requirements**

Room Name:

Program Number(s):

1. E3.01.11	7.	13.	19.	25.	31.	37.	43.
2.	8.	14.	20.	26.	32.	38.	44.
3.	9.	15.	21.	27.	33.	39.	45.
4.	10.	16.	22.	28.	34.	40.	46.
5.	11.	17.	23.	29.	35.	41.	47.
6.	12.	18.	24.	30.	36.	42.	48.

**ARCHITECTURAL REQUIREMENTS**

<b>WALL AND CEILING</b> Wall Material: <input type="text" value="ARGB 1.2m AFF, GB above"/> Finish: <input type="text" value="EWC"/> Ceiling Material: <input type="text" value="ACT-C"/> Finish: <input type="text" value="PF"/>	<b>WALL PROTECTION</b> Type: <input type="text" value="FRP"/> <input type="checkbox"/> Corner Guards <input type="checkbox"/> Hand Rails <input type="checkbox"/> Bed Bumper / Locator Height: <input type="text" value="2185 mm"/> <input type="checkbox"/> Crash Rails <input type="checkbox"/> Chair Rail	<b>GLAZING</b> <input type="checkbox"/> Interior Glazing	<b>FLOORING TYPES</b> Material: <input type="text" value="WSVF"/> Base: <input type="text" value="FCB"/>	<b>ROOM ACCESSORIES</b> <input type="checkbox"/> Coat Hooks <input type="checkbox"/> Ceiling Lift <input type="checkbox"/> Magnetic Whiteboard <input type="checkbox"/> Mirror <input type="checkbox"/> Infant Change Table <input type="checkbox"/> Privacy Curtain
---	--	---	---	--

- LEGEND:**
- WALL AND CEILING LEGEND:**
- AC Architectural Ceiling
  - ACT Acoustic Ceiling Tile
  - ACT-C Cleanroom
  - ARGB Abuse-Resistant Gypsum Board
  - GB Gypsum Board
  - IRGB Impact-Resistant Gypsum Board
  - KLCT Kitchen Lay-in Ceiling Tile
  - MMRGB Moisture and Mould-Resistant Gypsum Board
  - SACT Security Acoustic Ceiling Tile
- WALL FINISHES LEGEND:**
- EWC Epoxy Wall Coating
  - HPC High Performance Coating
  - PT Paint
- CEILING FINISHES LEGEND:**
- ECC Epoxy Ceiling Coating
  - HPC High Performance Coating
  - PF Prefinished
  - PT Paint
- WALL PROTECTION LEGEND:**
- ESRP Extruded Semi-Rigid PVCu Panel
  - FRL Fibre Reinforced Laminate
  - FRP Fibreglass Reinforced Plastic
  - PVVW Protective Vinyl Wallcovering
  - RHIS Rigid High Impact Sheet
  - WSSP Wetwall Solid Surface Panel
  - WVVW Wetroom Vinyl Wallcovering
- FLOOR FINISHES LEGEND:**
- CFS Concrete Floor Sealer
  - EFC Epoxy Floor Coating
  - PFC Polyurethane Floor Coating
  - RAF Rubber Athletic Flooring
  - RSF Rubber Sheet Flooring
  - SCF Seamless Cushioned Flooring
  - SDRF Static-Dissipative Rubber Sheet Flooring
  - SDVF Static-Dissipative Vinyl Sheet Flooring
  - VSF Vinyl Sheet Flooring
  - WSVF Wetroom Safety Vinyl Sheet Flooring
- FLOOR BASE LEGEND:**
- FCB Flash Cove Base
  - RB Rubber Base
  - SCF Seamless Cushioned Flooring

**DOORS**

Types:

Type	Qty	Size (mm)	Material	Finish	Side Lt.	Blinds	Protect.	Privacy Film	Function	Card Reader	Mag Lock	Auto Opener	Hold Open	Hinges	Accessory 1	Accessory 2	Accessory 3	Closer

Door Remarks:  Security Grille  Anti-barricade strategy

**MILLWORK AND SPECIALTY CASEWORK**

Storage Requirements:

**UPPER UNITS** (U1-U8) **SHELF** (S1)

**FULL-HEIGHT CABINETS** (C1-C5) **LOWER UNITS** (L1-L12) **RECEPTION/TRANSACTION COUNTER / CARE TEAM STATION DESK** (TC1-TC2) **UTILITY SINK AND COUNTER UNIT** (UC1)

Category	Min. Length (mm)	Motorized Adjustable Height	Standing Height	Specialty Casework
Category 0 - None				
Category 1 - Low (1% - 4%)				
Category 2 - Med (5% - 9%)				
Category 3 - High (10% or Greater)				

**FINISHES**

Full-height Cabinet:   
 Upper Millwork:   
 Countertop:   
 Lower Millwork:   
 Shelf:

Remarks:

**MECHANICAL REQUIREMENTS**

<b>PLUMBING</b> (Quantity) Hand Hygiene Sink: <input type="text"/> Lavatory: <input type="text"/> Kitchen Sink: <input type="text"/> Seamless Kitchen Sink: <input type="text"/> Utility / Process Sink: <input type="text"/> Scrub Sink: <input type="text"/> Floor Sink: <input type="text"/> Plumbing Remarks: <input type="text"/>	Other Fixtures: <input type="checkbox"/> Shower <input type="checkbox"/> Eyewash Station <input type="checkbox"/> Tub <input type="checkbox"/> Eyewash/Shower Station <input type="checkbox"/> Ice Maker <input type="checkbox"/> Emergency Shower <input type="checkbox"/> Water Closet <input type="checkbox"/> Flush Rim Sink <input type="checkbox"/> Instantaneous Hot Water <input type="checkbox"/> Floor Drain <input type="checkbox"/> <input type="checkbox"/> Water Bottle Refill Station Other <input type="text"/>	<b>MED / NON-MED GASES</b> (Quantity) Oxygen: <input type="text"/> Medical Air: <input type="text"/> Medical Vacuum: <input type="text"/> Nitrous Oxide: <input type="text"/> CO2: <input type="text"/> AGSS: <input type="text"/> Nitrogen: <input type="text"/> Laboratory Air: <input type="text"/> Laboratory Vacuum: <input type="text"/> Utility Compressed Air: <input type="text"/> Gas Remarks: <input type="text"/>
---	--	---

**Appendix 1B Minimum Room Requirements**

Room Name:

Program Number(s):

1. E5.01.02	7.	13.	19.	25.	31.	37.	43.
2.	8.	14.	20.	26.	32.	38.	44.
3.	9.	15.	21.	27.	33.	39.	45.
4.	10.	16.	22.	28.	34.	40.	46.
5.	11.	17.	23.	29.	35.	41.	47.
6.	12.	18.	24.	30.	36.	42.	48.

**ARCHITECTURAL REQUIREMENTS**

<b>WALL AND CEILING</b> Wall Material: <input type="text"/> Ceiling Material: <input type="text"/> Finish: <input type="text"/> Finish: <input type="text"/>	<b>WALL PROTECTION</b> Type: <input type="text"/> Height: <input type="text"/> <input type="checkbox"/> Corner Guards <input type="checkbox"/> Hand Rails <input type="checkbox"/> Bed Bumper / Locator <input type="checkbox"/> Crash Rails <input type="checkbox"/> Chair Rail	<b>GLAZING</b> <input type="checkbox"/> Interior Glazing	<b>FLOORING TYPES</b> Material: <input type="text"/> Base: <input type="text"/>	<b>ROOM ACCESSORIES</b> <input type="checkbox"/> Coat Hooks <input type="checkbox"/> Ceiling Lift <input type="checkbox"/> Magnetic Whiteboard <input type="checkbox"/> Mirror <input type="checkbox"/> Infant Change Table <input type="checkbox"/> Privacy Curtain
--	---	---	---	--

- LEGEND:**
- WALL AND CEILING LEGEND:**
- AC Architectural Ceiling
  - ACT Acoustic Ceiling Tile
  - ACT-C Cleanroom
  - ARGB Abuse-Resistant Gypsum Board
  - GB Gypsum Board
  - IRGB Impact-Resistant Gypsum Board
  - KLCT Kitchen Lay-in Ceiling Tile
  - MMRGB Moisture and Mould-Resistant Gypsum Board
  - SACT Security Acoustic Ceiling Tile
- WALL FINISHES LEGEND:**
- EWC Epoxy Wall Coating
  - HPC High Performance Coating
  - PT Paint
- CEILING FINISHES LEGEND:**
- ECC Epoxy Ceiling Coating
  - HPC High Performance Coating
  - PF Prefinished
  - PT Paint
- WALL PROTECTION LEGEND:**
- ESRP Extruded Semi-Rigid PVCu Panel
  - FRL Fibre Reinforced Laminate
  - FRP Fibreglass Reinforced Plastic
  - PVV Protective Vinyl Wallcovering
  - RHIS Rigid High Impact Sheet
  - WSSP Wetwall Solid Surface Panel
  - WVV Wetroom Vinyl Wallcovering
- FLOOR FINISHES LEGEND:**
- CFS Concrete Floor Sealer
  - EFC Epoxy Floor Coating
  - PFC Polyurethane Floor Coating
  - RAF Rubber Athletic Flooring
  - RSF Rubber Sheet Flooring
  - SCF Seamless Cushioned Flooring
  - SDRF Static-Dissipative Rubber Sheet Flooring
  - SDVF Static-Dissipative Vinyl Sheet Flooring
  - VSF Vinyl Sheet Flooring
  - WSVF Wetroom Safety Vinyl Sheet Flooring
- FLOOR BASE LEGEND:**
- FCB Flash Cove Base
  - RB Rubber Base
  - SCF Seamless Cushioned Flooring

**DOORS**

Types:

Type:Qty:	Size (mm):	Material:	Finish:	Side Lt:	Blinds:	Protect.:	Privacy Film:	Function:	Card Reader:	Mag Lock:	Auto Opener:	Hold Open:	Hinges:	Accessory 1:	Accessory 2:	Accessory 3:	Closer:
<input type="checkbox"/>				<input type="checkbox"/>	<input type="checkbox"/>		<input type="checkbox"/>		<input type="checkbox"/>	<input type="checkbox"/>	<input type="checkbox"/>	<input type="checkbox"/>					

Door Remarks:

Security Grille  
 Anti-barricade strategy

**MILLWORK AND SPECIALTY CASEWORK**

Storage Requirements:

**UPPER UNITS** (U1-U8)

**LOWER UNITS** (L1-L12)

**RECEPTION/TRANSACTION COUNTER / CARE TEAM STATION DESK** (TC1, TC2)

**UTILITY SINK AND COUNTER UNIT** (UC1)

**SHELF** (S1)

**FULL-HEIGHT CABINETS** (C1-C5)

**Legend:**

Category	Min. Length (mm)	Motorized Adjustable Height	Standing Height	Specialty Casework
Category 0 - None				
Category 1 - Low (1% - 4%)		<input type="checkbox"/>	<input type="checkbox"/>	<input type="checkbox"/>
Category 2 - Med (5% - 9%)				
Category 3 - High (10% or Greater)				

**FINISHES**

Full-height Cabinet:   
 Upper Millwork:   
 Countertop:   
 Lower Millwork:   
 Shelf:

Remarks:

**MECHANICAL REQUIREMENTS**

<b>PLUMBING</b> (Quantity) Hand Hygiene Sink: <input type="text"/> Lavatory: <input type="text"/> Kitchen Sink: <input type="text"/> Kitchen Sink: <input type="text"/> Utility / Process Sink: <input type="text"/> Scrub Sink: <input type="text"/> Floor Sink: <input type="text"/> Plumbing Remarks: <input type="text"/>	Other Fixtures: <input type="checkbox"/> Shower <input type="checkbox"/> Tub <input type="checkbox"/> Ice Maker <input type="checkbox"/> Water Closet <input type="checkbox"/> Instantaneous Hot Water <input type="checkbox"/> Eyewash Station <input type="checkbox"/> Eyewash/Shower Station <input type="checkbox"/> Emergency Shower <input type="checkbox"/> Flush Rim Sink <input type="checkbox"/> Floor Drain <input type="checkbox"/> Water Bottle Refill Station Other: <input type="text"/>	<b>MED / NON-MED GASES</b> (Quantity) Oxygen: <input type="text"/> Medical Air: <input type="text"/> Medical Vacuum: <input type="text"/> Nitrous Oxide: <input type="text"/> CO2: <input type="text"/> AGSS: <input type="text"/> Nitrogen: <input type="text"/> Laboratory Air: <input type="text"/> Laboratory Vacuum: <input type="text"/> Utility Compressed Air: <input type="text"/> Gas Remarks: <input type="text"/>
--	---	---



**Appendix 1B Minimum Room Requirements**

Room Name:

Program Number(s):

1. E2.01.03	7.	13.	19.	25.	31.	37.	43.
2.	8.	14.	20.	26.	32.	38.	44.
3.	9.	15.	21.	27.	33.	39.	45.
4.	10.	16.	22.	28.	34.	40.	46.
5.	11.	17.	23.	29.	35.	41.	47.
6.	12.	18.	24.	30.	36.	42.	48.

**ARCHITECTURAL REQUIREMENTS**

<b>WALL AND CEILING</b> Wall Material: <input type="text" value="ARGB 1.2m AFF, GB above"/> Finish: <input type="text" value="EWC"/> Ceiling Material: <input type="text" value="ACT-C"/> Finish: <input type="text" value="PF"/>	<b>WALL PROTECTION</b> Type: <input type="text" value="FRP"/> <input type="checkbox"/> Corner Guards <input type="checkbox"/> Hand Rails <input type="checkbox"/> Bed Bumper / Locator Height: <input type="text" value="2185 mm"/> <input type="checkbox"/> Crash Rails <input type="checkbox"/> Chair Rail	<b>GLAZING</b> <input type="checkbox"/> Interior Glazing	<b>FLOORING TYPES</b> Material: <input type="text" value="VSF"/> Base: <input type="text" value="FCB"/>	<b>ROOM ACCESSORIES</b> <input type="checkbox"/> Coat Hooks <input type="checkbox"/> Ceiling Lift <input checked="" type="checkbox"/> Magnetic Whiteboard <input type="checkbox"/> Mirror <input type="checkbox"/> Infant Change Table <input type="checkbox"/> Privacy Curtain
---	--	---	--	---

- LEGEND:**
- WALL AND CEILING LEGEND:**
- AC Architectural Ceiling
  - ACT Acoustic Ceiling Tile
  - ACT-C Cleanroom
  - ARGB Abuse-Resistant Gypsum Board
  - GB Gypsum Board
  - IRGB Impact-Resistant Gypsum Board
  - KLCT Kitchen Lay-in Ceiling Tile
  - MMRGB Moisture and Mould-Resistant Gypsum Board
  - SACT Security Acoustic Ceiling Tile
- WALL FINISHES LEGEND:**
- EWC Epoxy Wall Coating
  - HPC High Performance Coating
  - PT Paint
- CEILING FINISHES LEGEND:**
- ECC Epoxy Ceiling Coating
  - HPC High Performance Coating
  - PF Prefinished
  - PT Paint
- WALL PROTECTION LEGEND:**
- ESRP Extruded Semi-Rigid PVCu Panel
  - FRL Fibre Reinforced Laminate
  - FRP Fibreglass Reinforced Plastic
  - PVV Protective Vinyl Wallcovering
  - RHIS Rigid High Impact Sheet
  - WSSP Wetwall Solid Surface Panel
  - WVV Wetroom Vinyl Wallcovering
- FLOOR FINISHES LEGEND:**
- CFS Concrete Floor Sealer
  - EFC Epoxy Floor Coating
  - PFC Polyurethane Floor Coating
  - RAF Rubber Athletic Flooring
  - RSF Rubber Sheet Flooring
  - SCF Seamless Cushioned Flooring
  - SDRF Static-Dissipative Rubber Sheet Flooring
  - SDVF Static-Dissipative Vinyl Sheet Flooring
  - VSF Vinyl Sheet Flooring
  - WSVF Wetroom Safety Vinyl Sheet Flooring
- FLOOR BASE LEGEND:**
- FCB Flash Cove Base
  - RB Rubber Base
  - SCF Seamless Cushioned Flooring

**DOORS**

Types:

Type	Qty	Size (mm)	Material	Finish	Side Lt	Blinds	Protect	Privacy Film	Function	Card Reader	Mag Lock	Auto Opener	Hold Open	Hinges	Accessory 1	Accessory 2	Accessory 3	Closer

Door Remarks:  Security Grille  Anti-barricade strategy

**MILLWORK AND SPECIALTY CASEWORK**

Storage Requirements:

**UPPER UNITS** (U1-U8) **SHELF** (S1)

**FULL-HEIGHT CABINETS** (C1-C5, L1-L9)

**LOWER UNITS** (L10-L12) **RECEPTION/TRANSACTION COUNTER / CARE TEAM STATION DESK** (TC1, TC2) **UTILITY SINK AND COUNTER UNIT** (UC1)

Category	Min. Length (mm)	Motorized Adjustable Height	Standing Height	Specialty Casework
3	3300	<input checked="" type="checkbox"/>	<input checked="" type="checkbox"/>	<input checked="" type="checkbox"/>

**FINISHES**

Full-height Cabinet:   
 Upper Millwork:   
 Countertop:   
 Lower Millwork:   
 Shelf:

Remarks: Refer to Schedule 1, Section 6.12 (Division 12) for Specialty Casework. Items indicated are diagrammatic, provide specialty casework appropriate for the specific and specialized functions to be performed in the space and to accommodate Equipment. Provide laboratory casework, quantity (1).

**MECHANICAL REQUIREMENTS**

<b>PLUMBING</b> (Quantity) Hand Hygiene Sink: <input type="text"/> Lavatory: <input type="text"/> Kitchen Sink: <input type="text"/> Kitchen Sink: <input type="text"/> Utility / Process Sink: <input type="text" value="1"/> Scrub Sink: <input type="text"/> Floor Sink: <input type="text"/> Plumbing Remarks: <input type="text"/>	Other Fixtures: <input type="checkbox"/> Shower <input type="checkbox"/> Eyewash Station <input type="checkbox"/> Tub <input type="checkbox"/> Eyewash/Shower Station <input type="checkbox"/> Ice Maker <input type="checkbox"/> Emergency Shower <input type="checkbox"/> Water Closet <input type="checkbox"/> Flush Rim Sink <input type="checkbox"/> Instantaneous Hot Water <input type="checkbox"/> Floor Drain <input type="checkbox"/> <input type="checkbox"/> Water Bottle Refill Station Other: <input type="text"/>	<b>MED / NON-MED GASES</b> (Quantity) Oxygen: <input type="text"/> Medical Air: <input type="text"/> Medical Vacuum: <input type="text"/> Nitrous Oxide: <input type="text"/> CO2: <input type="text"/> AGSS: <input type="text"/> Nitrogen: <input type="text"/> Laboratory Air: <input type="text"/> Laboratory Vacuum: <input type="text" value="1"/> Utility Compressed Air: <input type="text"/> Gas Remarks: Each sink to be equipped with faucet complete with vacuum breaker to avoid any siphonage and potential contamination on water network
--	---	--

**Appendix 1B Minimum Room Requirements**

Room Name:

Program Number(s):

1.	E1.03	7.		13.		19.		25.		31.		37.		43.
2.		8.		14.		20.		26.		32.		38.		44.
3.		9.		15.		21.		27.		33.		39.		45.
4.		10.		16.		22.		28.		34.		40.		46.
5.		11.		17.		23.		29.		35.		41.		47.
6.		12.		18.		24.		30.		36.		42.		48.

**ARCHITECTURAL REQUIREMENTS**

<b>WALL AND CEILING</b> Wall Material: <input type="text" value="ARGB 1.2m AFF, GB above"/> Finish: <input type="text" value="PT"/> Ceiling Material: <input type="text" value="ACT-C"/> Finish: <input type="text" value="PF"/>		<b>WALL PROTECTION</b> Type: <input type="text" value="FRP"/> <input checked="" type="checkbox"/> Corner Guards <input type="checkbox"/> Hand Rails <input type="checkbox"/> Bed Bumper / Locator Height: <input type="text" value="2185 mm"/> <input type="checkbox"/> Crash Rails <input type="checkbox"/> Chair Rail		<b>GLAZING</b> <input checked="" type="checkbox"/> Interior Glazing		<b>FLOORING TYPES</b> Material: <input type="text" value="VSF"/> Base: <input type="text" value="FCB"/>		<b>ROOM ACCESSORIES</b> <input type="checkbox"/> Coat Hooks <input type="checkbox"/> Ceiling Lift <input checked="" type="checkbox"/> Magnetic Whiteboard <input type="checkbox"/> Mirror <input type="checkbox"/> Infant Change Table <input type="checkbox"/> Privacy Curtain	
--	--	---	--	--	--	--	--	---	--

- LEGEND:**
- WALL AND CEILING LEGEND:**
- AC Architectural Ceiling
  - ACT Acoustic Ceiling Tile
  - ACT-C Cleanroom
  - ARGB Abuse-Resistant Gypsum Board
  - GB Gypsum Board
  - IRGB Impact-Resistant Gypsum Board
  - KLCT Kitchen Lay-in Ceiling Tile
  - MMRGB Moisture and Mould-Resistant Gypsum Board
  - SACT Security Acoustic Ceiling Tile
- WALL FINISHES LEGEND:**
- EWC Epoxy Wall Coating
  - HPC High Performance Coating
  - PT Paint
- CEILING FINISHES LEGEND:**
- ECC Epoxy Ceiling Coating
  - HPC High Performance Coating
  - PF Prefinished
  - PT Paint
- WALL PROTECTION LEGEND:**
- ESRP Extruded Semi-Rigid PVCu Panel
  - FRL Fibre Reinforced Laminate
  - FRP Fibreglass Reinforced Plastic
  - PVV Protective Vinyl Wallcovering
  - RHIS Rigid High Impact Sheet
  - WSSP Wetwall Solid Surface Panel
  - WVV Wetroom Vinyl Wallcovering
- FLOOR FINISHES LEGEND:**
- CFS Concrete Floor Sealer
  - EFC Epoxy Floor Coating
  - PFC Polyurethane Floor Coating
  - RAF Rubber Athletic Flooring
  - RSF Rubber Sheet Flooring
  - SCF Seamless Cushioned Flooring
  - SDRF Static-Dissipative Rubber Sheet Flooring
  - SDVF Static-Dissipative Vinyl Sheet Flooring
  - VSF Vinyl Sheet Flooring
  - WSVF Wetroom Safety Vinyl Sheet Flooring
- FLOOR BASE LEGEND:**
- FCB Flash Cove Base
  - RB Rubber Base
  - SCF Seamless Cushioned Flooring

**DOORS**

Types:

Type	Qty	Size (mm)	Material	Finish	Side Lt.	Blinds	Protect.	Privacy Film	Function	Card Reader	Mag Lock	Auto Opener	Hold Open	Hinges	Accessory 1	Accessory 2	Accessory 3	Closer
B	2	1065 x 2135	Solid Core	FRL	<input type="checkbox"/>	<input type="checkbox"/>	2 High	<input type="checkbox"/>	Storeroom	<input checked="" type="checkbox"/>	<input type="checkbox"/>	<input type="checkbox"/>	<input checked="" type="checkbox"/>	Butt Hinge				Surface

Door Remarks: Provide remote door opening capabilities to door from corridor at the transaction window.

Security Grille  
 Anti-barricade strategy

**MILLWORK AND SPECIALTY CASEWORK**

**UPPER UNITS** (U1-U8) **LOWER UNITS** (L1-L9, L10-L12) **SHELF** (S1) **RECEPTION/TRANSACTION COUNTER / CARE TEAM STATION DESK** (TC1, TC2) **UTILITY SINK AND COUNTER UNIT** (UC1)

Storage Requirements:

Category	Min. Length (mm)	Motorized Adjustable Height	Standing Height	Specialty Casework
2	1800	<input type="checkbox"/>	<input type="checkbox"/>	<input type="checkbox"/>

**FINISHES**

Full-height Cabinet:   
 Upper Millwork:   
 Countertop:   
 Lower Millwork:   
 Shelf:

Remarks:

**MECHANICAL REQUIREMENTS**

<b>PLUMBING</b> (Quantity) Hygiene Sink: <input type="text"/> Lavatory: <input type="text"/> Kitchen Sink: <input type="text"/> Seamless Kitchen Sink: <input type="text"/> Utility / Process Sink: <input type="text"/> Scrub Sink: <input type="text"/> Floor Sink: <input type="text"/>							Other Fixtures: <input type="checkbox"/> Shower <input type="checkbox"/> Tub <input type="checkbox"/> Ice Maker <input type="checkbox"/> Water Closet <input type="checkbox"/> Instantaneous Hot Water				<input type="checkbox"/> Eyewash Station <input type="checkbox"/> Eyewash/Shower Station <input type="checkbox"/> Emergency Shower <input type="checkbox"/> Flush Rim Sink <input type="checkbox"/> Floor Drain <input type="checkbox"/> Water Bottle Refill Station				<b>MED / NON-MED GASES</b> (Quantity) Oxygen: <input type="text"/> Medical Air: <input type="text"/> Medical Vacuum: <input type="text"/> Nitrous Oxide: <input type="text"/> CO2: <input type="text"/> AGSS: <input type="text"/> Nitrogen: <input type="text"/> Laboratory Air: <input type="text"/> Laboratory Vacuum: <input type="text"/> Utility Compressed Air: <input type="text"/>				
Plumbing Remarks: <input type="text"/>							Gas Remarks: <input type="text"/>												

# Appendix 1B Minimum Room Requirements

Room Name:

Program Number(s):

1. E2.03	7.	13.	19.	25.	31.	37.	43.
2.	8.	14.	20.	26.	32.	38.	44.
3.	9.	15.	21.	27.	33.	39.	45.
4.	10.	16.	22.	28.	34.	40.	46.
5.	11.	17.	23.	29.	35.	41.	47.
6.	12.	18.	24.	30.	36.	42.	48.

## ARCHITECTURAL REQUIREMENTS

<b>WALL AND CEILING</b> Wall Material: <input type="text" value="ARGB 1.2m AFF, GB above"/> Finish: <input type="text" value="EWC"/> Ceiling Material: <input type="text" value="ACT-C"/> Finish: <input type="text" value="PF"/>		<b>WALL PROTECTION</b> Type: <input type="text" value="FRP"/> <input checked="" type="checkbox"/> Corner Guards <input type="checkbox"/> Hand Rails <input type="checkbox"/> Bed Bumper / Locator Height: <input type="text" value="2185 mm"/> <input type="checkbox"/> Crash Rails <input type="checkbox"/> Chair Rail		<b>GLAZING</b> <input type="checkbox"/> Interior Glazing		<b>FLOORING TYPES</b> Material: <input type="text"/> Base: <input type="text"/>		<b>ROOM ACCESSORIES</b> <input type="checkbox"/> Coat Hooks <input type="checkbox"/> Ceiling Lift <input type="checkbox"/> Magnetic Whiteboard <input type="checkbox"/> Mirror <input type="checkbox"/> Infant Change Table <input type="checkbox"/> Privacy Curtain	
---	--	---	--	---	--	--	--	--	--

- LEGEND:**
- WALL AND CEILING LEGEND:**
- AC Architectural Ceiling
  - ACT Acoustic Ceiling Tile
  - ACT-C Cleanroom
  - ARGB Abuse-Resistant Gypsum Board
  - GB Gypsum Board
  - IRGB Impact-Resistant Gypsum Board
  - KLCT Kitchen Lay-in Ceiling Tile
  - MMRGB Moisture and Mould-Resistant Gypsum Board
  - SACT Security Acoustic Ceiling Tile
- WALL FINISHES LEGEND:**
- EWC Epoxy Wall Coating
  - HPC High Performance Coating
  - PT Paint
- CEILING FINISHES LEGEND:**
- ECC Epoxy Ceiling Coating
  - HPC High Performance Coating
  - PF Prefinished
  - PT Paint
- WALL PROTECTION LEGEND:**
- ESRP Extruded Semi-Rigid PVCu Panel
  - FRL Fibre Reinforced Laminate
  - FRP Fibreglass Reinforced Plastic
  - PVV Protective Vinyl Wallcovering
  - RHIS Rigid High Impact Sheet
  - WSSP Wetwall Solid Surface Panel
  - WVV Wetroom Vinyl Wallcovering
- FLOOR FINISHES LEGEND:**
- CFS Concrete Floor Sealer
  - EFC Epoxy Floor Coating
  - PFC Polyurethane Floor Coating
  - RAF Rubber Athletic Flooring
  - RSF Rubber Sheet Flooring
  - SCF Seamless Cushioned Flooring
  - SDRF Static-Dissipative Rubber Sheet Flooring
  - SDVF Static-Dissipative Vinyl Sheet Flooring
  - VSF Vinyl Sheet Flooring
  - WSVF Wetroom Safety Vinyl Sheet Flooring
- FLOOR BASE LEGEND:**
- FCB Flash Cove Base
  - RB Rubber Base
  - SCF Seamless Cushioned Flooring

**DOORS**

Types:

Type	Qty	Size (mm)	Material	Finish	Side Lt.	Blinds	Protect.	Privacy Film	Function	Card Reader	Mag Lock	Auto Opener	Hold Open	Hinges	Accessory 1	Accessory 2	Accessory 3	Closer	

Door Remarks:  Security Grille  Anti-barricade strategy

**MILLWORK AND SPECIALTY CASEWORK**

**UPPER UNITS** (U1-U8) **SHELF** (S1)

**LOWER UNITS** (L1-L12) **RECEPTION/TRANSACTION COUNTER / CARE TEAM STATION DESK** (TC1, TC2) **UTILITY SINK AND COUNTER UNIT** (UC1)

**FULL-HEIGHT CABINETS** (C1-C5)

Storage Requirements:

**FINISHES**

Full-height Cabinet:   
 Upper Millwork:   
 Countertop:   
 Lower Millwork:   
 Shelf:

Remarks: Refer to Schedule 1, Section 6.13 (Division 13) for Walk-in Refrigerators and Cold Rooms

Category	Min. Length (mm)	Motorized Adjustable Height	Standing Height	Specialty Casework
Category 0 - None				
Category 1 - Low (1% - 4%)				
Category 2 - Med (5% - 9%)				
Category 3 - High (10% or Greater)				

## MECHANICAL REQUIREMENTS

<b>PLUMBING</b> (Quantity) Hygiene Sink: <input type="text"/> Lavatory: <input type="text"/> Kitchen Sink: <input type="text"/> Kitchen Sink: <input type="text"/> Utility / Process Sink: <input type="text"/> Scrub Sink: <input type="text"/> Floor Sink: <input type="text"/>		Other Fixtures: <input type="checkbox"/> Shower <input type="checkbox"/> Eyewash Station <input type="checkbox"/> Tub <input type="checkbox"/> Eyewash/Shower Station <input type="checkbox"/> Ice Maker <input type="checkbox"/> Emergency Shower <input type="checkbox"/> Water Closet <input checked="" type="checkbox"/> Floor Drain <input type="checkbox"/> Instantaneous Hot Water <input type="checkbox"/> Water Bottle Refill Station Other: <input type="text"/>		<b>MED / NON-MED GASES</b> (Quantity) Oxygen: <input type="text"/> Medical Air: <input type="text"/> Medical Vacuum: <input type="text"/> Nitrous Oxide: <input type="text"/> CO2: <input type="text"/> AGSS: <input type="text"/> Nitrogen: <input type="text"/> Laboratory Air: <input type="text"/> Laboratory Vacuum: <input type="text"/> Utility Compressed Air: <input type="text"/>	
Plumbing Remarks: Provide indirect drain to funnel floor sink located outside of the walk in. Placement not to impede door path of travel or cart movement				Gas Remarks: <input type="text"/>	



**Appendix 1B Minimum Room Requirements**

Room Name:

Program Number(s):

1. E6.01	7.	13.	19.	25.	31.	37.	43.
2.	8.	14.	20.	26.	32.	38.	44.
3.	9.	15.	21.	27.	33.	39.	45.
4.	10.	16.	22.	28.	34.	40.	46.
5.	11.	17.	23.	29.	35.	41.	47.
6.	12.	18.	24.	30.	36.	42.	48.

**ARCHITECTURAL REQUIREMENTS**

<b>WALL AND CEILING</b> Wall Material: <input type="text" value="ARGB 1.2m AFF, GB above"/> Finish: <input type="text" value="EWC"/> Ceiling Material: <input type="text" value="ACT-C"/> Finish: <input type="text" value="PF"/>		<b>WALL PROTECTION</b> Type: <input type="text" value="FRP"/> <input checked="" type="checkbox"/> Corner Guards <input type="checkbox"/> Hand Rails <input type="checkbox"/> Bed Bumper / Locator Height: <input type="text" value="2185 mm"/> <input type="checkbox"/> Crash Rails <input type="checkbox"/> Chair Rail		<b>GLAZING</b> <input type="checkbox"/> Interior Glazing		<b>FLOORING TYPES</b> Material: <input type="text" value="VSF"/> Base: <input type="text" value="FCB"/>		<b>ROOM ACCESSORIES</b> <input type="checkbox"/> Coat Hooks <input type="checkbox"/> Ceiling Lift <input type="checkbox"/> Magnetic Whiteboard <input type="checkbox"/> Mirror <input type="checkbox"/> Infant Change Table <input type="checkbox"/> Privacy Curtain	
---	--	---	--	---	--	--	--	--	--

- LEGEND:**
- WALL AND CEILING LEGEND:**
- AC Architectural Ceiling
  - ACT Acoustic Ceiling Tile
  - ACT-C Cleanroom
  - ARGB Abuse-Resistant Gypsum Board
  - GB Gypsum Board
  - IRGB Impact-Resistant Gypsum Board
  - KLCT Kitchen Lay-in Ceiling Tile
  - MMRGB Moisture and Mould-Resistant Gypsum Board
  - SACT Security Acoustic Ceiling Tile
- WALL FINISHES LEGEND:**
- EWC Epoxy Wall Coating
  - HPC High Performance Coating
  - PT Paint
- CEILING FINISHES LEGEND:**
- ECC Epoxy Ceiling Coating
  - HPC High Performance Coating
  - PF Prefinished
  - PT Paint
- WALL PROTECTION LEGEND:**
- ESRP Extruded Semi-Rigid PVCu Panel
  - FRL Fibre Reinforced Laminate
  - FRP Fibreglass Reinforced Plastic
  - PVV Protective Vinyl Wallcovering
  - RHIS Rigid High Impact Sheet
  - WSSP Wetwall Solid Surface Panel
  - WVV Wetroom Vinyl Wallcovering
- FLOOR FINISHES LEGEND:**
- CFS Concrete Floor Sealer
  - EFC Epoxy Floor Coating
  - PFC Polyurethane Floor Coating
  - RAF Rubber Athletic Flooring
  - RSF Rubber Sheet Flooring
  - SCF Seamless Cushioned Flooring
  - SDRF Static-Dissipative Rubber Sheet Flooring
  - SDVF Static-Dissipative Vinyl Sheet Flooring
  - VSF Vinyl Sheet Flooring
  - WSVF Wetroom Safety Vinyl Sheet Flooring
- FLOOR BASE LEGEND:**
- FCB Flash Cove Base
  - RB Rubber Base
  - SCF Seamless Cushioned Flooring

**DOORS**

Types:

Type	Qty	Size (mm)	Material	Finish	Side Lt.	Blinds	Protect.	Privacy Film	Function	Card Reader	Mag Lock	Auto Opener	Hold Open	Hinges	Accessory 1	Accessory 2	Accessory 3	Closer
C	1	1065 x 2135	Solid Core	FRL	<input type="checkbox"/>	<input type="checkbox"/>	2 High	<input checked="" type="checkbox"/>	Classroom	<input type="checkbox"/>	<input type="checkbox"/>	<input checked="" type="checkbox"/>	<input type="checkbox"/>	Butt Hinge	Elec. Strike			Surface

Door Remarks:

Security Grille  
 Anti-barricade strategy

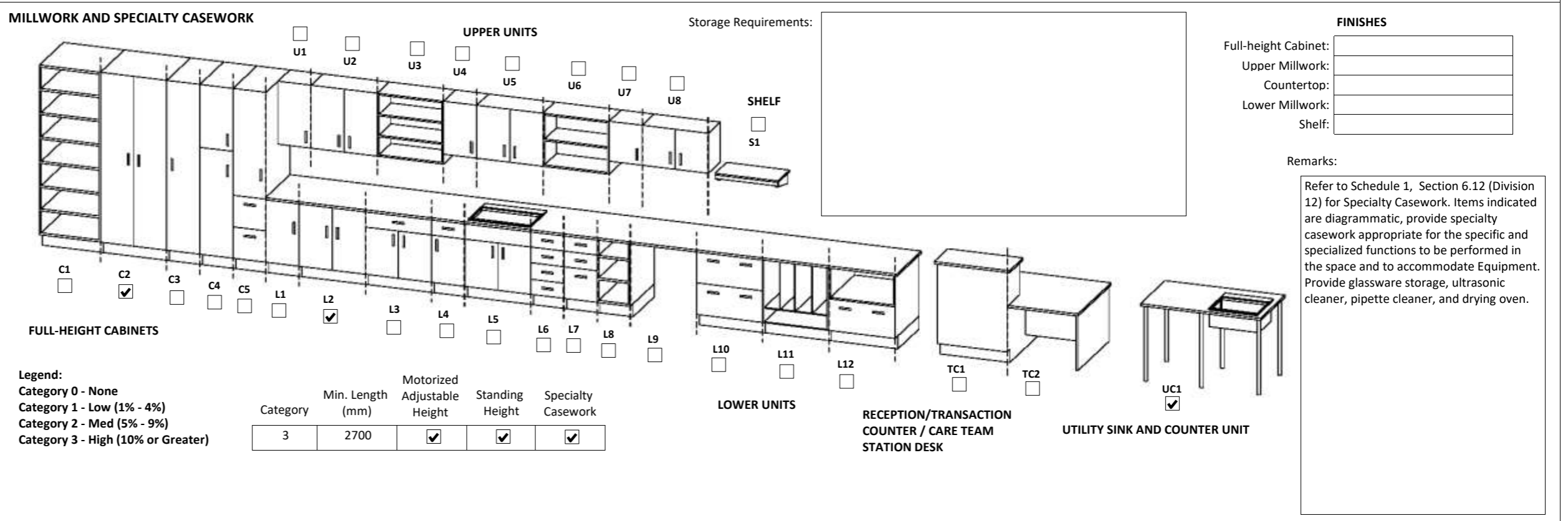

**MECHANICAL REQUIREMENTS**

<b>PLUMBING</b> (Quantity)		Hand Hygiene Sink: <input type="text" value="1"/>		Lavatory: <input type="text"/>		Kitchen Sink: <input type="text"/>		Seamless Kitchen Sink: <input type="text"/>		Utility / Process Sink: <input type="text" value="1"/>		Scrub Sink: <input type="text"/>		Floor Sink: <input type="text"/>							
Plumbing Remarks: <input type="text" value="RO water for ultrasonic required"/>		Other Fixtures:				<input type="checkbox"/> Shower <input type="checkbox"/> Tub <input type="checkbox"/> Ice Maker <input type="checkbox"/> Water Closet <input type="checkbox"/> Instantaneous Hot Water				<input type="checkbox"/> Eyewash Station <input type="checkbox"/> Eyewash/Shower Station <input type="checkbox"/> Emergency Shower <input type="checkbox"/> Flush Rim Sink <input type="checkbox"/> Floor Drain <input type="checkbox"/> Water Bottle Refill Station Other: <input type="text"/>											
<b>MED / NON-MED GASES</b> (Quantity)		Oxygen: <input type="text"/>		Medical Air: <input type="text"/>		Medical Vacuum: <input type="text"/>		Nitrous Oxide: <input type="text"/>		CO2: <input type="text"/>		AGSS: <input type="text"/>		Nitrogen: <input type="text"/>		Laboratory Air: <input type="text"/>		Laboratory Vacuum: <input type="text"/>		Utility Compressed Air: <input type="text"/>	
Gas Remarks: <input type="text"/>																					

**Appendix 1B Minimum Room Requirements**

Room Name:

Program Number(s):

1. E3.01.10	7.	13.	19.	25.	31.	37.	43.
2.	8.	14.	20.	26.	32.	38.	44.
3.	9.	15.	21.	27.	33.	39.	45.
4.	10.	16.	22.	28.	34.	40.	46.
5.	11.	17.	23.	29.	35.	41.	47.
6.	12.	18.	24.	30.	36.	42.	48.

**ARCHITECTURAL REQUIREMENTS**

<b>WALL AND CEILING</b> Wall Material: <input type="text"/> Ceiling Material: <input type="text"/> Finish: <input type="text"/> Finish: <input type="text"/>	<b>WALL PROTECTION</b> Type: <input type="text"/> Height: <input type="text"/> <input type="checkbox"/> Corner Guards <input type="checkbox"/> Hand Rails <input type="checkbox"/> Bed Bumper / Locator <input type="checkbox"/> Crash Rails <input type="checkbox"/> Chair Rail	<b>GLAZING</b> <input type="checkbox"/> Interior Glazing	<b>FLOORING TYPES</b> Material: <input type="text"/> Base: <input type="text"/>	<b>ROOM ACCESSORIES</b> <input type="checkbox"/> Coat Hooks <input type="checkbox"/> Ceiling Lift <input type="checkbox"/> Magnetic Whiteboard <input type="checkbox"/> Mirror <input type="checkbox"/> Infant Change Table <input type="checkbox"/> Privacy Curtain
--	---	---	---	--

- LEGEND:**
- WALL AND CEILING LEGEND:**
- AC Architectural Ceiling
  - ACT Acoustic Ceiling Tile
  - ACT-C Cleanroom
  - ARGB Abuse-Resistant Gypsum Board
  - GB Gypsum Board
  - IRGB Impact-Resistant Gypsum Board
  - KLCT Kitchen Lay-in Ceiling Tile
  - MMRGB Moisture and Mould-Resistant Gypsum Board
  - SACT Security Acoustic Ceiling Tile
- WALL FINISHES LEGEND:**
- EWC Epoxy Wall Coating
  - HPC High Performance Coating
  - PT Paint
- CEILING FINISHES LEGEND:**
- ECC Epoxy Ceiling Coating
  - HPC High Performance Coating
  - PF Prefinished
  - PT Paint
- WALL PROTECTION LEGEND:**
- ESRP Extruded Semi-Rigid PVCu Panel
  - FRL Fibre Reinforced Laminate
  - FRP Fibreglass Reinforced Plastic
  - PVV Protective Vinyl Wallcovering
  - RHIS Rigid High Impact Sheet
  - WSSP Wetwall Solid Surface Panel
  - WVV Wetroom Vinyl Wallcovering
- FLOOR FINISHES LEGEND:**
- CFS Concrete Floor Sealer
  - EFC Epoxy Floor Coating
  - PFC Polyurethane Floor Coating
  - RAF Rubber Athletic Flooring
  - RSF Rubber Sheet Flooring
  - SCF Seamless Cushioned Flooring
  - SDRF Static-Dissipative Rubber Sheet Flooring
  - SDVF Static-Dissipative Vinyl Sheet Flooring
  - VSF Vinyl Sheet Flooring
  - WSVF Wetroom Safety Vinyl Sheet Flooring
- FLOOR BASE LEGEND:**
- FCB Flash Cove Base
  - RB Rubber Base
  - SCF Seamless Cushioned Flooring

**DOORS**

Types:

Type	Qty	Size (mm)	Material	Finish	Side Lt	Blinds	Protect	Privacy Film	Function	Card Reader	Mag Lock	Auto Opener	Hold Open	Hinges	Accessory 1	Accessory 2	Accessory 3	Closer

Door Remarks:

Security Grille  
 Anti-barricade strategy

**MILLWORK AND SPECIALTY CASEWORK**

Storage Requirements:

**UPPER UNITS** (U1-U8)

**LOWER UNITS** (L1-L12)

**RECEPTION/TRANSACTION COUNTER / CARE TEAM STATION DESK** (TC1, TC2)

**UTILITY SINK AND COUNTER UNIT** (UC1)

**FINISHES**

Full-height Cabinet:   
 Upper Millwork:   
 Countertop:   
 Lower Millwork:   
 Shelf:

Remarks:

**Legend:**

Category	Min. Length (mm)	Motorized Adjustable Height	Standing Height	Specialty Casework
Category 0 - None				
Category 1 - Low (1% - 4%)				
Category 2 - Med (5% - 9%)				
Category 3 - High (10% or Greater)				

**MECHANICAL REQUIREMENTS**

<b>PLUMBING</b> (Quantity) Hand Hygiene Sink: <input type="text"/> Lavatory: <input type="text"/> Kitchen Sink: <input type="text"/> Seamless Kitchen Sink: <input type="text"/> Utility / Process Sink: <input type="text"/> Scrub Sink: <input type="text"/> Floor Sink: <input type="text"/> Plumbing Remarks: <input type="text"/>	Other Fixtures: <input type="checkbox"/> Shower <input type="checkbox"/> Tub <input type="checkbox"/> Ice Maker <input type="checkbox"/> Water Closet <input type="checkbox"/> Instantaneous Hot Water <input type="checkbox"/> Eyewash Station <input type="checkbox"/> Eyewash/Shower Station <input type="checkbox"/> Emergency Shower <input type="checkbox"/> Flush Rim Sink <input type="checkbox"/> Floor Drain <input type="checkbox"/> Water Bottle Refill Station Other: <input type="text"/>	<b>MED / NON-MED GASES</b> (Quantity) Oxygen: <input type="text"/> Medical Air: <input type="text"/> Medical Vacuum: <input type="text"/> Nitrous Oxide: <input type="text"/> CO2: <input type="text"/> AGSS: <input type="text"/> Nitrogen: <input type="text"/> Laboratory Air: <input type="text"/> Laboratory Vacuum: <input type="text"/> Utility Compressed Air: <input type="text"/> Gas Remarks: <input type="text"/>
---	---	---

**Appendix 1B Minimum Room Requirements**

Room Name:

Program Number(s):

1. E2.01.08	7.	13.	19.	25.	31.	37.	43.
2.	8.	14.	20.	26.	32.	38.	44.
3.	9.	15.	21.	27.	33.	39.	45.
4.	10.	16.	22.	28.	34.	40.	46.
5.	11.	17.	23.	29.	35.	41.	47.
6.	12.	18.	24.	30.	36.	42.	48.

**ARCHITECTURAL REQUIREMENTS**

<b>WALL AND CEILING</b> Wall Material: <input type="text" value="ARGB 1.2m AFF, GB above"/> Finish: <input type="text" value="HPC"/> Ceiling Material: <input type="text" value="ACT-C"/> Finish: <input type="text" value="PF"/>	<b>WALL PROTECTION</b> Type: <input type="text" value="FRP"/> <input type="checkbox"/> Corner Guards <input type="checkbox"/> Hand Rails <input type="checkbox"/> Bed Bumper / Locator Height: <input type="text" value="2185 mm"/> <input type="checkbox"/> Crash Rails <input checked="" type="checkbox"/> Chair Rail	<b>GLAZING</b> <input type="checkbox"/> Interior Glazing	<b>FLOORING TYPES</b> Material: <input type="text" value="VSF"/> Base: <input type="text" value="FCB"/>	<b>ROOM ACCESSORIES</b> <input type="checkbox"/> Coat Hooks <input type="checkbox"/> Ceiling Lift <input checked="" type="checkbox"/> Magnetic Whiteboard <input type="checkbox"/> Mirror <input type="checkbox"/> Infant Change Table <input type="checkbox"/> Privacy Curtain
---	---	---	--	---

- LEGEND:**
- WALL AND CEILING LEGEND:**
- AC Architectural Ceiling
  - ACT Acoustic Ceiling Tile
  - ACT-C Cleanroom
  - ARGB Abuse-Resistant Gypsum Board
  - GB Gypsum Board
  - IRGB Impact-Resistant Gypsum Board
  - KLCT Kitchen Lay-in Ceiling Tile
  - MMRGB Moisture and Mould-Resistant Gypsum Board
  - SACT Security Acoustic Ceiling Tile
- WALL FINISHES LEGEND:**
- EWC Epoxy Wall Coating
  - HPC High Performance Coating
  - PT Paint
- CEILING FINISHES LEGEND:**
- ECC Epoxy Ceiling Coating
  - HPC High Performance Coating
  - PF Prefinished
  - PT Paint
- WALL PROTECTION LEGEND:**
- ESRP Extruded Semi-Rigid PVCu Panel
  - FRL Fibre Reinforced Laminate
  - FRP Fibreglass Reinforced Plastic
  - PVV Protective Vinyl Wallcovering
  - RHIS Rigid High Impact Sheet
  - WSSP Wetwall Solid Surface Panel
  - WVV Wetroom Vinyl Wallcovering
- FLOOR FINISHES LEGEND:**
- CFS Concrete Floor Sealer
  - EFC Epoxy Floor Coating
  - PFC Polyurethane Floor Coating
  - RAF Rubber Athletic Flooring
  - RSF Rubber Sheet Flooring
  - SCF Seamless Cushioned Flooring
  - SDRF Static-Dissipative Rubber Sheet Flooring
  - SDVF Static-Dissipative Vinyl Sheet Flooring
  - VSF Vinyl Sheet Flooring
  - WSVF Wetroom Safety Vinyl Sheet Flooring
- FLOOR BASE LEGEND:**
- FCB Flash Cove Base
  - RB Rubber Base
  - SCF Seamless Cushioned Flooring

**DOORS**

Types:

Type	Qty	Size (mm)	Material	Finish	Side Lt.	Blinds	Protect.	Privacy Film	Function	Card Reader	Mag Lock	Auto Opener	Hold Open	Hinges	Accessory 1	Accessory 2	Accessory 3	Closer	

Door Remarks:  Security Grille  Anti-barricade strategy

**MILLWORK AND SPECIALTY CASEWORK**

Storage Requirements:

**UPPER UNITS** (U1-U8) **SHELF** (S1)

**FULL-HEIGHT CABINETS** (C1-C5, L1-L9)

**LOWER UNITS** (L10-L12) **RECEPTION/TRANSACTION COUNTER / CARE TEAM STATION DESK** (TC1-TC2) **UTILITY SINK AND COUNTER UNIT** (UC1)

Category	Min. Length (mm)	Motorized Adjustable Height	Standing Height	Specialty Casework
3	1800	<input checked="" type="checkbox"/>	<input checked="" type="checkbox"/>	<input checked="" type="checkbox"/>

**FINISHES**

Full-height Cabinet:   
 Upper Millwork:   
 Countertop:   
 Lower Millwork:   
 Shelf:

Remarks: Refer to Schedule 1, Section 6.12 (Division 12) for Specialty Casework. Items indicated are diagrammatic, provide specialty casework appropriate for the specific and specialized functions to be performed in the space and to accommodate Equipment. Provide analyzers and osmometer analyzer.

**MECHANICAL REQUIREMENTS**

<b>PLUMBING</b> (Quantity) Hand Hygiene Sink: <input type="text"/> Lavatory: <input type="text"/> Kitchen Sink: <input type="text"/> Seamless Kitchen Sink: <input type="text"/> Utility / Process Sink: <input type="text"/> Scrub Sink: <input type="text"/> Floor Sink: <input type="text"/> Plumbing Remarks: <input type="text"/>	Other Fixtures: <input type="checkbox"/> Shower <input type="checkbox"/> Tub <input type="checkbox"/> Ice Maker <input type="checkbox"/> Water Closet <input type="checkbox"/> Instantaneous Hot Water <input type="checkbox"/> Ewewash Station <input type="checkbox"/> Eyewash/Shower Station <input type="checkbox"/> Emergency Shower <input type="checkbox"/> Flush Rim Sink <input type="checkbox"/> Floor Drain <input type="checkbox"/> Water Bottle Refill Station Other: <input type="text"/>	<b>MED / NON-MED GASES</b> (Quantity) Oxygen: <input type="text"/> Medical Air: <input type="text"/> Medical Vacuum: <input type="text"/> Nitrous Oxide: <input type="text"/> CO2: <input type="text"/> AGSS: <input type="text"/> Nitrogen: <input type="text"/> Laboratory Air: <input type="text"/> Laboratory Vacuum: <input type="text"/> Utility Compressed Air: <input type="text"/> Gas Remarks: <input type="text"/>
---	--	---



**Appendix 1B Minimum Room Requirements**

Room Name:

Program Number(s):

1. E3.01.07	7.	13.	19.	25.	31.	37.	43.
2.	8.	14.	20.	26.	32.	38.	44.
3.	9.	15.	21.	27.	33.	39.	45.
4.	10.	16.	22.	28.	34.	40.	46.
5.	11.	17.	23.	29.	35.	41.	47.
6.	12.	18.	24.	30.	36.	42.	48.

**ARCHITECTURAL REQUIREMENTS**

<b>WALL AND CEILING</b> Wall Material: <input type="text" value="ARGB 1.2m AFF, GB above"/> Finish: <input type="text" value="EWC"/> Ceiling Material: <input type="text" value="ACT-C"/> Finish: <input type="text" value="PF"/>	<b>WALL PROTECTION</b> Type: <input type="text" value="FRP"/> <input type="checkbox"/> Corner Guards <input type="checkbox"/> Hand Rails <input type="checkbox"/> Bed Bumper / Locator Height: <input type="text" value="2185 mm"/> <input type="checkbox"/> Crash Rails <input checked="" type="checkbox"/> Chair Rail	<b>GLAZING</b> <input type="checkbox"/> Interior Glazing	<b>FLOORING TYPES</b> Material: <input type="text" value="VSF"/> Base: <input type="text" value="FCB"/>	<b>ROOM ACCESSORIES</b> <input type="checkbox"/> Coat Hooks <input type="checkbox"/> Ceiling Lift <input checked="" type="checkbox"/> Magnetic Whiteboard <input type="checkbox"/> Mirror <input type="checkbox"/> Infant Change Table <input type="checkbox"/> Privacy Curtain
---	---	---	--	---

- LEGEND:**
- WALL AND CEILING LEGEND:**
- AC Architectural Ceiling
  - ACT Acoustic Ceiling Tile
  - ACT-C Cleanroom
  - ARGB Abuse-Resistant Gypsum Board
  - GB Gypsum Board
  - IRGB Impact-Resistant Gypsum Board
  - KLCT Kitchen Lay-in Ceiling Tile
  - MMRGB Moisture and Mould-Resistant Gypsum Board
  - SACT Security Acoustic Ceiling Tile
- WALL FINISHES LEGEND:**
- EWC Epoxy Wall Coating
  - HPC High Performance Coating
  - PT Paint
- CEILING FINISHES LEGEND:**
- ECC Epoxy Ceiling Coating
  - HPC High Performance Coating
  - PF Prefinished
  - PT Paint
- WALL PROTECTION LEGEND:**
- ESRP Extruded Semi-Rigid PVCu Panel
  - FRL Fibre Reinforced Laminate
  - FRP Fibreglass Reinforced Plastic
  - PVV Protective Vinyl Wallcovering
  - RHIS Rigid High Impact Sheet
  - WSSP Wetwall Solid Surface Panel
  - WVV Wetroom Vinyl Wallcovering
- FLOOR FINISHES LEGEND:**
- CFS Concrete Floor Sealer
  - EFC Epoxy Floor Coating
  - PFC Polyurethane Floor Coating
  - RAF Rubber Athletic Flooring
  - RSF Rubber Sheet Flooring
  - SCF Seamless Cushioned Flooring
  - SDRF Static-Dissipative Rubber Sheet Flooring
  - SDVF Static-Dissipative Vinyl Sheet Flooring
  - VSF Vinyl Sheet Flooring
  - WSVF Wetroom Safety Vinyl Sheet Flooring
- FLOOR BASE LEGEND:**
- FCB Flash Cove Base
  - RB Rubber Base
  - SCF Seamless Cushioned Flooring

**DOORS**

Types:

Type	Qty	Size (mm)	Material	Finish	Side Lt.	Blinds	Protect.	Privacy Film	Function	Card Reader	Mag Lock	Auto Opener	Hold Open	Hinges	Accessory 1	Accessory 2	Accessory 3	Closer

Door Remarks:  Security Grille  Anti-barricade strategy

**MILLWORK AND SPECIALTY CASEWORK**

Storage Requirements:

**UPPER UNITS** U1, U2, U3, U4, U5, U6, U7, U8

**LOWER UNITS** L10, L11, L12

**RECEPTION/TRANSACTION COUNTER / CARE TEAM STATION DESK** TC1, TC2

**UTILITY SINK AND COUNTER UNIT** UC1

**FULL-HEIGHT CABINETS** C1, C2, C3, C4, C5

**LEGEND:**

Category	Min. Length (mm)	Motorized Adjustable Height	Standing Height	Specialty Casework
3	1800	<input checked="" type="checkbox"/>	<input type="checkbox"/>	<input checked="" type="checkbox"/>

**FINISHES**

Full-height Cabinet:   
 Upper Millwork:   
 Countertop:   
 Lower Millwork:   
 Shelf:

Remarks: Refer to Schedule 1, Section 6.12 (Division 12) for Specialty Casework. Items indicated are diagrammatic, provide specialty casework appropriate for the specific and specialized functions to be performed in the space and to accommodate Equipment. Provide sed rate area and 1 computer.

**MECHANICAL REQUIREMENTS**

<b>PLUMBING</b> (Quantity) Hand Hygiene Sink: <input type="text"/> Lavatory: <input type="text"/> Kitchen Sink: <input type="text"/> Seamless Kitchen Sink: <input type="text"/> Utility / Process Sink: <input type="text" value="1"/> Scrub Sink: <input type="text"/> Floor Sink: <input type="text"/> Plumbing Remarks: <input type="text"/>	Other Fixtures: <input type="checkbox"/> Shower <input type="checkbox"/> Eyewash Station <input type="checkbox"/> Tub <input type="checkbox"/> Eyewash/Shower Station <input type="checkbox"/> Ice Maker <input type="checkbox"/> Emergency Shower <input type="checkbox"/> Water Closet <input type="checkbox"/> Flush Rim Sink <input type="checkbox"/> Instantaneous Hot Water <input type="checkbox"/> Floor Drain <input type="checkbox"/> <input type="checkbox"/> Water Bottle Refill Station Other <input type="text"/>	<b>MED / NON-MED GASES</b> (Quantity) Oxygen: <input type="text"/> Medical Air: <input type="text"/> Medical Vacuum: <input type="text"/> Nitrous Oxide: <input type="text"/> CO2: <input type="text"/> AGSS: <input type="text"/> Nitrogen: <input type="text"/> Laboratory Air: <input type="text"/> Laboratory Vacuum: <input type="text"/> Utility Compressed Air: <input type="text"/> Gas Remarks: <input type="text"/>
---	--	---

**Appendix 1B Minimum Room Requirements**

Room Name:

Program Number(s):

1. E3.01.03	7.	13.	19.	25.	31.	37.	43.
2.	8.	14.	20.	26.	32.	38.	44.
3.	9.	15.	21.	27.	33.	39.	45.
4.	10.	16.	22.	28.	34.	40.	46.
5.	11.	17.	23.	29.	35.	41.	47.
6.	12.	18.	24.	30.	36.	42.	48.

**ARCHITECTURAL REQUIREMENTS**

<b>WALL AND CEILING</b> Wall Material: <input type="text" value="ARGB 1.2m AFF, GB above"/> Finish: <input type="text" value="EWC"/> Ceiling Material: <input type="text" value="ACT-C"/> Finish: <input type="text" value="PF"/>	<b>WALL PROTECTION</b> Type: <input type="text" value="FRP"/> <input type="checkbox"/> Corner Guards <input type="checkbox"/> Hand Rails <input type="checkbox"/> Bed Bumper / Locator Height: <input type="text" value="2185 mm"/> <input type="checkbox"/> Crash Rails <input checked="" type="checkbox"/> Chair Rail	<b>GLAZING</b> <input type="checkbox"/> Interior Glazing	<b>FLOORING TYPES</b> Material: <input type="text" value="VSF"/> Base: <input type="text" value="FCB"/>	<b>ROOM ACCESSORIES</b> <input checked="" type="checkbox"/> Coat Hooks <input type="checkbox"/> Ceiling Lift <input checked="" type="checkbox"/> Magnetic Whiteboard <input type="checkbox"/> Mirror <input type="checkbox"/> Infant Change Table <input type="checkbox"/> Privacy Curtain
---	---	---	--	--

- LEGEND:**
- WALL AND CEILING LEGEND:**
- AC Architectural Ceiling
  - ACT Acoustic Ceiling Tile
  - ACT-C Cleanroom
  - ARGB Abuse-Resistant Gypsum Board
  - GB Gypsum Board
  - IRGB Impact-Resistant Gypsum Board
  - KLCT Kitchen Lay-in Ceiling Tile
  - MMRGB Moisture and Mould-Resistant Gypsum Board
  - SACT Security Acoustic Ceiling Tile
- WALL FINISHES LEGEND:**
- EWC Epoxy Wall Coating
  - HPC High Performance Coating
  - PT Paint
- CEILING FINISHES LEGEND:**
- ECC Epoxy Ceiling Coating
  - HPC High Performance Coating
  - PF Prefinished
  - PT Paint
- WALL PROTECTION LEGEND:**
- ESRP Extruded Semi-Rigid PVCu Panel
  - FRL Fibre Reinforced Laminate
  - FRP Fibreglass Reinforced Plastic
  - PVV Protective Vinyl Wallcovering
  - RHIS Rigid High Impact Sheet
  - WSSP Wetwall Solid Surface Panel
  - WWW Wetroom Vinyl Wallcovering
- FLOOR FINISHES LEGEND:**
- CFS Concrete Floor Sealer
  - EFC Epoxy Floor Coating
  - PFC Polyurethane Floor Coating
  - RAF Rubber Athletic Flooring
  - RSF Rubber Sheet Flooring
  - SCF Seamless Cushioned Flooring
  - SDRF Static-Dissipative Rubber Sheet Flooring
  - SDVF Static-Dissipative Vinyl Sheet Flooring
  - VSF Vinyl Sheet Flooring
  - WSVF Wetroom Safety Vinyl Sheet Flooring
- FLOOR BASE LEGEND:**
- FCB Flash Cove Base
  - RB Rubber Base
  - SCF Seamless Cushioned Flooring

**DOORS**

Types:

Type:Qty:	Size (mm):	Material:	Finish:	Side Lt:	Blinds:	Protect.:	Privacy Film:	Function:	Card Reader:	Mag Lock:	Auto Opener:	Hold Open:	Hinges:	Accessory 1:	Accessory 2:	Accessory 3:	Closer:

Door Remarks:  Security Grille  Anti-barricade strategy

**MILLWORK AND SPECIALTY CASEWORK**

**UPPER UNITS** (U1-U8) **LOWER UNITS** (L1-L12) **RECEPTION/TRANSACTION COUNTER / CARE TEAM STATION DESK** (TC1-TC2) **UTILITY SINK AND COUNTER UNIT** (UC1)

Storage Requirements:

**FINISHES**

Full-height Cabinet:   
 Upper Millwork:   
 Countertop:   
 Lower Millwork:   
 Shelf:

Remarks: Refer to Schedule 1, Section 6.12 (Division 12) for Specialty Casework. Items indicated are diagrammatic, provide specialty casework appropriate for the specific and specialized functions to be performed in the space and to accommodate Equipment. Provide 2 microscopes, and 2 computers at end of Auto Cell Counter.

Category	Min. Length (mm)	Motorized Adjustable Height	Standing Height	Specialty Casework
3	2700	<input checked="" type="checkbox"/>	<input checked="" type="checkbox"/>	<input checked="" type="checkbox"/>

**MECHANICAL REQUIREMENTS**

<b>PLUMBING</b> (Quantity) Hand Hygiene Sink: <input type="text"/> Lavatory: <input type="text"/> Kitchen Sink: <input type="text"/> Seamless Kitchen Sink: <input type="text"/> Utility / Process Sink: <input type="text"/> Scrub Sink: <input type="text"/> Floor Sink: <input type="text"/> Plumbing Remarks: <input type="text"/>	Other Fixtures: <input type="checkbox"/> Shower <input type="checkbox"/> Tub <input type="checkbox"/> Ice Maker <input type="checkbox"/> Water Closet <input type="checkbox"/> Instantaneous Hot Water <input type="checkbox"/> Ewewash Station <input type="checkbox"/> Eyewash/Shower Station <input type="checkbox"/> Emergency Shower <input type="checkbox"/> Flush Rim Sink <input type="checkbox"/> Floor Drain <input type="checkbox"/> Water Bottle Refill Station Other: <input type="text"/>	<b>MED / NON-MED GASES</b> (Quantity) Oxygen: <input type="text"/> Medical Air: <input type="text"/> Medical Vacuum: <input type="text"/> Nitrous Oxide: <input type="text"/> CO2: <input type="text"/> AGSS: <input type="text"/> Nitrogen: <input type="text"/> Laboratory Air: <input type="text"/> Laboratory Vacuum: <input type="text"/> Utility Compressed Air: <input type="text"/> Gas Remarks: <input type="text"/>
---	--	---

# Appendix 1B Minimum Room Requirements

Room Name:

Program Number(s):

1. E3.01.04	7.	13.	19.	25.	31.	37.	43.
2.	8.	14.	20.	26.	32.	38.	44.
3.	9.	15.	21.	27.	33.	39.	45.
4.	10.	16.	22.	28.	34.	40.	46.
5.	11.	17.	23.	29.	35.	41.	47.
6.	12.	18.	24.	30.	36.	42.	48.

## ARCHITECTURAL REQUIREMENTS

<b>WALL AND CEILING</b> Wall Material: <input type="text" value="ARGB 1.2m AFF, GB above"/> Finish: <input type="text" value="EWC"/> Ceiling Material: <input type="text" value="ACT-C"/> Finish: <input type="text" value="PF"/>	<b>WALL PROTECTION</b> Type: <input type="text" value="FRP"/> <input type="checkbox"/> Corner Guards <input type="checkbox"/> Hand Rails <input type="checkbox"/> Bed Bumper / Locator Height: <input type="text" value="2185 mm"/> <input type="checkbox"/> Crash Rails <input checked="" type="checkbox"/> Chair Rail	<b>GLAZING</b> <input type="checkbox"/> Interior Glazing	<b>FLOORING TYPES</b> Material: <input type="text" value="VSF"/> Base: <input type="text" value="FCB"/>	<b>ROOM ACCESSORIES</b> <input checked="" type="checkbox"/> Coat Hooks <input type="checkbox"/> Ceiling Lift <input checked="" type="checkbox"/> Magnetic Whiteboard <input type="checkbox"/> Mirror <input type="checkbox"/> Infant Change Table <input type="checkbox"/> Privacy Curtain
---	---	---	--	--

- LEGEND:**
- WALL AND CEILING LEGEND:**
- AC Architectural Ceiling
  - ACT Acoustic Ceiling Tile
  - ACT-C Cleanroom
  - ARGB Abuse-Resistant Gypsum Board
  - GB Gypsum Board
  - IRGB Impact-Resistant Gypsum Board
  - KLCT Kitchen Lay-in Ceiling Tile
  - MMRGB Moisture and Mould-Resistant Gypsum Board
  - SACT Security Acoustic Ceiling Tile
- WALL FINISHES LEGEND:**
- EWC Epoxy Wall Coating
  - HPC High Performance Coating
  - PT Paint
- CEILING FINISHES LEGEND:**
- ECC Epoxy Ceiling Coating
  - HPC High Performance Coating
  - PF Prefinished
  - PT Paint
- WALL PROTECTION LEGEND:**
- ESRP Extruded Semi-Rigid PVCu Panel
  - FRL Fibre Reinforced Laminate
  - FRP Fibreglass Reinforced Plastic
  - PVV Protective Vinyl Wallcovering
  - RHIS Rigid High Impact Sheet
  - WSSP Wetwall Solid Surface Panel
  - WVV Wetroom Vinyl Wallcovering
- FLOOR FINISHES LEGEND:**
- CFS Concrete Floor Sealer
  - EFC Epoxy Floor Coating
  - PFC Polyurethane Floor Coating
  - RAF Rubber Athletic Flooring
  - RSF Rubber Sheet Flooring
  - SCF Seamless Cushioned Flooring
  - SDRF Static-Dissipative Rubber Sheet Flooring
  - SDVF Static-Dissipative Vinyl Sheet Flooring
  - VSF Vinyl Sheet Flooring
  - WSVF Wetroom Safety Vinyl Sheet Flooring
- FLOOR BASE LEGEND:**
- FCB Flash Cove Base
  - RB Rubber Base
  - SCF Seamless Cushioned Flooring

**DOORS**

Types:

Type	Qty	Size (mm)	Material	Finish	Side Lt.	Blinds	Protect.	Privacy Film	Function	Card Reader	Mag Lock	Auto Opener	Hold Open	Hinges	Accessory 1	Accessory 2	Accessory 3	Closer

Door Remarks:  Security Grille  Anti-barricade strategy

**MILLWORK AND SPECIALTY CASEWORK**

Storage Requirements:

**UPPER UNITS** U1 U2 U3 U4 U5 U6 U7 U8

**LOWER UNITS** L10 L11 L12

**RECEPTION/TRANSACTION COUNTER / CARE TEAM STATION DESK** TC1 TC2

**UTILITY SINK AND COUNTER UNIT** UC1

**SHELF** S1

**FULL-HEIGHT CABINETS** C1 C2 C3 C4 C5

Category	Min. Length (mm)	Motorized Adjustable Height	Standing Height	Specialty Casework
3	4200	<input checked="" type="checkbox"/>	<input checked="" type="checkbox"/>	<input checked="" type="checkbox"/>

**FINISHES**

Full-height Cabinet:   
 Upper Millwork:   
 Countertop:   
 Lower Millwork:   
 Shelf:

Remarks: Refer to Schedule 1, Section 6.12 (Division 12) for Specialty Casework. Items indicated are diagrammatic, provide specialty casework appropriate for the specific and specialized functions to be performed in the space and to accommodate Equipment. Provide setup bench, u/c storage, and STAT stainer.

## MECHANICAL REQUIREMENTS

<b>PLUMBING</b> (Quantity) Hand Hygiene Sink: <input type="text"/> Lavatory: <input type="text"/> Kitchen Sink: <input type="text"/> Seamless Kitchen Sink: <input type="text"/> Utility / Process Sink: <input type="text" value="1"/> Scrub Sink: <input type="text"/> Floor Sink: <input type="text"/> Plumbing Remarks: <input type="text"/>	Other Fixtures: <input type="checkbox"/> Shower <input type="checkbox"/> Eyewash Station <input type="checkbox"/> Tub <input type="checkbox"/> Eyewash/Shower Station <input type="checkbox"/> Ice Maker <input type="checkbox"/> Emergency Shower <input type="checkbox"/> Water Closet <input type="checkbox"/> Flush Rim Sink <input type="checkbox"/> Instantaneous Hot Water <input type="checkbox"/> Floor Drain <input type="checkbox"/> <input type="checkbox"/> Water Bottle Refill Station Other: <input type="text"/>	<b>MED / NON-MED GASES</b> (Quantity) Oxygen: <input type="text"/> Medical Air: <input type="text"/> Medical Vacuum: <input type="text"/> Nitrous Oxide: <input type="text"/> CO2: <input type="text"/> AGSS: <input type="text"/> Nitrogen: <input type="text"/> Laboratory Air: <input type="text"/> Laboratory Vacuum: <input type="text"/> Utility Compressed Air: <input type="text"/> Gas Remarks: <input type="text"/>
---	---	---



# Appendix 1B Minimum Room Requirements

Room Name:

Program Number(s):

1. E5.01.01	7.	13.	19.	25.	31.	37.	43.
2.	8.	14.	20.	26.	32.	38.	44.
3.	9.	15.	21.	27.	33.	39.	45.
4.	10.	16.	22.	28.	34.	40.	46.
5.	11.	17.	23.	29.	35.	41.	47.
6.	12.	18.	24.	30.	36.	42.	48.

## ARCHITECTURAL REQUIREMENTS

<b>WALL AND CEILING</b> Wall Material: <input type="text"/> Ceiling Material: <input type="text"/> Finish: <input type="text"/> Finish: <input type="text"/>	<b>WALL PROTECTION</b> Type: <input type="text"/> Height: <input type="text"/> <input type="checkbox"/> Corner Guards <input type="checkbox"/> Hand Rails <input type="checkbox"/> Bed Bumper / Locator <input type="checkbox"/> Crash Rails <input type="checkbox"/> Chair Rail	<b>GLAZING</b> <input type="checkbox"/> Interior Glazing	<b>FLOORING TYPES</b> Material: <input type="text"/> Base: <input type="text"/>	<b>ROOM ACCESSORIES</b> <input type="checkbox"/> Coat Hooks <input type="checkbox"/> Ceiling Lift <input type="checkbox"/> Magnetic Whiteboard <input type="checkbox"/> Mirror <input type="checkbox"/> Infant Change Table <input type="checkbox"/> Privacy Curtain
--	--	---	--	--

- LEGEND:**
- WALL AND CEILING LEGEND:**
- AC Architectural Ceiling
  - ACT Acoustic Ceiling Tile
  - ACT-C Cleanroom
  - ARGB Abuse-Resistant Gypsum Board
  - GB Gypsum Board
  - IRGB Impact-Resistant Gypsum Board
  - KLCT Kitchen Lay-in Ceiling Tile
  - MMRGB Moisture and Mould-Resistant Gypsum Board
  - SACT Security Acoustic Ceiling Tile
- WALL FINISHES LEGEND:**
- EWC Epoxy Wall Coating
  - HPC High Performance Coating
  - PT Paint
- CEILING FINISHES LEGEND:**
- ECC Epoxy Ceiling Coating
  - HPC High Performance Coating
  - PF Prefinished
  - PT Paint
- WALL PROTECTION LEGEND:**
- ESRP Extruded Semi-Rigid PVCu Panel
  - FRL Fibre Reinforced Laminate
  - FRP Fibreglass Reinforced Plastic
  - PVV Protective Vinyl Wallcovering
  - RHIS Rigid High Impact Sheet
  - WSSP Wetwall Solid Surface Panel
  - WVV Wetroom Vinyl Wallcovering
- FLOOR FINISHES LEGEND:**
- CFS Concrete Floor Sealer
  - EFC Epoxy Floor Coating
  - PFC Polyurethane Floor Coating
  - RAF Rubber Athletic Flooring
  - RSF Rubber Sheet Flooring
  - SCF Seamless Cushioned Flooring
  - SDRF Static-Dissipative Rubber Sheet Flooring
  - SDVF Static-Dissipative Vinyl Sheet Flooring
  - VSF Vinyl Sheet Flooring
  - WSVF Wetroom Safety Vinyl Sheet Flooring
- FLOOR BASE LEGEND:**
- FCB Flash Cove Base
  - RB Rubber Base
  - SCF Seamless Cushioned Flooring

**DOORS**

Types:

Type:Qty:	Size (mm):	Material:	Finish:	Side Lt:	Blinds:	Protect.:	Privacy Film:	Function:	Card Reader:	Mag Lock:	Auto Opener:	Hold Open:	Hinges:	Accessory 1:	Accessory 2:	Accessory 3:	Closer:

Door Remarks:

Security Grille  
 Anti-barricade strategy

**MILLWORK AND SPECIALTY CASEWORK**

Storage Requirements:

**UPPER UNITS** (U1-U8)   **SHELF** (S1)

**FULL-HEIGHT CABINETS** (C1-C5)   **LOWER UNITS** (L1-L12)

**RECEPTION/TRANSACTION COUNTER / CARE TEAM STATION DESK** (TC1, TC2)

**UTILITY SINK AND COUNTER UNIT** (UC1)

**FINISHES**

Full-height Cabinet:   
 Upper Millwork:   
 Countertop:   
 Lower Millwork:   
 Shelf:

Remarks:

**Legend:**

Category	Min. Length (mm)	Motorized Adjustable Height	Standing Height	Specialty Casework
Category 0 - None				
Category 1 - Low (1% - 4%)				
Category 2 - Med (5% - 9%)				
Category 3 - High (10% or Greater)				

## MECHANICAL REQUIREMENTS

<p><b>PLUMBING</b> (Quantity)</p> <table border="1"> <tr> <td>Hand Hygiene Sink:</td> <td>Lavatory:</td> <td>Kitchen Sink:</td> <td>Seamless Kitchen Sink:</td> <td>Utility / Process Sink:</td> <td>Scrub Sink:</td> <td>Floor Sink:</td> </tr> <tr> <td> </td> <td> </td> <td> </td> <td> </td> <td> </td> <td> </td> <td> </td> </tr> </table> <p>Plumbing Remarks: <input type="text"/></p>	Hand Hygiene Sink:	Lavatory:	Kitchen Sink:	Seamless Kitchen Sink:	Utility / Process Sink:	Scrub Sink:	Floor Sink:								<p>Other Fixtures:</p> <input type="checkbox"/> Shower <input type="checkbox"/> Eyewash Station <input type="checkbox"/> Tub <input type="checkbox"/> Eyewash/Shower Station <input type="checkbox"/> Ice Maker <input type="checkbox"/> Emergency Shower <input type="checkbox"/> Water Closet <input type="checkbox"/> Flush Rim Sink <input type="checkbox"/> Instantaneous Hot Water <input type="checkbox"/> Floor Drain <input type="checkbox"/> <input type="checkbox"/> Water Bottle Refill Station Other: <input type="text"/>	<p><b>MED / NON-MED GASES</b> (Quantity)</p> <table border="1"> <tr> <td>Oxygen:</td> <td>Medical Air:</td> <td>Medical Vacuum:</td> <td>Nitrous Oxide:</td> <td>CO2:</td> <td>AGSS:</td> <td>Nitrogen:</td> <td>Laboratory Air:</td> <td>Laboratory Vacuum:</td> <td>Utility Compressed Air:</td> </tr> <tr> <td> </td> <td> </td> <td> </td> <td> </td> <td> </td> <td> </td> <td> </td> <td> </td> <td> </td> <td> </td> </tr> </table> <p>Gas Remarks: <input type="text"/></p>	Oxygen:	Medical Air:	Medical Vacuum:	Nitrous Oxide:	CO2:	AGSS:	Nitrogen:	Laboratory Air:	Laboratory Vacuum:	Utility Compressed Air:										
Hand Hygiene Sink:	Lavatory:	Kitchen Sink:	Seamless Kitchen Sink:	Utility / Process Sink:	Scrub Sink:	Floor Sink:																														
Oxygen:	Medical Air:	Medical Vacuum:	Nitrous Oxide:	CO2:	AGSS:	Nitrogen:	Laboratory Air:	Laboratory Vacuum:	Utility Compressed Air:																											

**Appendix 1B Minimum Room Requirements**

Room Name:

Program Number(s):

1. E4.01.05	7.	13.	19.	25.	31.	37.	43.
2.	8.	14.	20.	26.	32.	38.	44.
3.	9.	15.	21.	27.	33.	39.	45.
4.	10.	16.	22.	28.	34.	40.	46.
5.	11.	17.	23.	29.	35.	41.	47.
6.	12.	18.	24.	30.	36.	42.	48.

**ARCHITECTURAL REQUIREMENTS**

<b>WALL AND CEILING</b> Wall Material: <input type="text" value="ARGB 1.2m AFF, GB above"/> Finish: <input type="text" value="EWC"/> Ceiling Material: <input type="text" value="ACT"/> Finish: <input type="text" value="ECC"/>		<b>WALL PROTECTION</b> Type: <input type="text" value="FRP"/> <input checked="" type="checkbox"/> Corner Guards <input type="checkbox"/> Hand Rails <input type="checkbox"/> Bed Bumper / Locator Height: <input type="text" value="2185 mm"/> <input type="checkbox"/> Crash Rails <input checked="" type="checkbox"/> Chair Rail			<b>GLAZING</b> <input type="checkbox"/> Interior Glazing		<b>FLOORING TYPES</b> Material: <input type="text" value="VSF"/> Base: <input type="text" value="FCB"/>		<b>ROOM ACCESSORIES</b> <input checked="" type="checkbox"/> Coat Hooks <input type="checkbox"/> Ceiling Lift <input checked="" type="checkbox"/> Magnetic Whiteboard <input type="checkbox"/> Mirror <input type="checkbox"/> Infant Change Table <input type="checkbox"/> Privacy Curtain		
--	--	--	--	--	---	--	--	--	--	--	--

- LEGEND:**
- WALL AND CEILING LEGEND:**
- AC Architectural Ceiling
  - ACT Acoustic Ceiling Tile
  - ACT-C Cleanroom
  - ARGB Abuse-Resistant Gypsum Board
  - GB Gypsum Board
  - IRGB Impact-Resistant Gypsum Board
  - KLCT Kitchen Lay-in Ceiling Tile
  - MMRGB Moisture and Mould-Resistant Gypsum Board
  - SACT Security Acoustic Ceiling Tile
- WALL FINISHES LEGEND:**
- EWC Epoxy Wall Coating
  - HPC High Performance Coating
  - PT Paint
- CEILING FINISHES LEGEND:**
- ECC Epoxy Ceiling Coating
  - HPC High Performance Coating
  - PF Prefinished
  - PT Paint
- WALL PROTECTION LEGEND:**
- ESRP Extruded Semi-Rigid PVCu Panel
  - FRL Fibre Reinforced Laminate
  - FRP Fibreglass Reinforced Plastic
  - PVV Protective Vinyl Wallcovering
  - RHIS Rigid High Impact Sheet
  - WSSP Wetwall Solid Surface Panel
  - WWW Wetroom Vinyl Wallcovering
- FLOOR FINISHES LEGEND:**
- CFS Concrete Floor Sealer
  - EFC Epoxy Floor Coating
  - PFC Polyurethane Floor Coating
  - RAF Rubber Athletic Flooring
  - RSF Rubber Sheet Flooring
  - SCF Seamless Cushioned Flooring
  - SDRF Static-Dissipative Rubber Sheet Flooring
  - SDVF Static-Dissipative Vinyl Sheet Flooring
  - VSF Vinyl Sheet Flooring
  - WSVF Wetroom Safety Vinyl Sheet Flooring
- FLOOR BASE LEGEND:**
- FCB Flash Cove Base
  - RB Rubber Base
  - SCF Seamless Cushioned Flooring

**DOORS**

Types:

Type:Qty:	Size (mm):	Material:	Finish:	Side Lt:	Blinds:	Protect.:	Privacy Film:	Function:	Card Reader:	Mag Lock:	Auto Opener:	Hold Open:	Hinges:	Accessory 1:	Accessory 2:	Accessory 3:	Closer:

Door Remarks:  Security Grille  Anti-barricade strategy

**MILLWORK AND SPECIALTY CASEWORK**

**UPPER UNITS** (U1-U8) **LOWER UNITS** (L1-L12) **RECEPTION/TRANSACTION COUNTER / CARE TEAM STATION DESK** (TC1-TC2) **UTILITY SINK AND COUNTER UNIT** (UC1)

Storage Requirements:

**FINISHES**

Full-height Cabinet:   
 Upper Millwork:   
 Countertop:   
 Lower Millwork:   
 Shelf:

Remarks: Refer to Schedule 1, Section 6.12 (Division 12) for Specialty Casework. Items indicated are diagrammatic, provide specialty casework appropriate for the specific and specialized functions to be performed in the space and to accommodate Equipment. Provide inventory and issuing area, workbench for routine crossmatch & Quality Assurance, blood product prep area, and automated workbench.

Category	Min. Length (mm)	Motorized Adjustable Height	Standing Height	Specialty Casework
2	4200	<input checked="" type="checkbox"/>	<input checked="" type="checkbox"/>	<input checked="" type="checkbox"/>

**MECHANICAL REQUIREMENTS**

<b>PLUMBING</b> (Quantity) Hygiene Sink: <input type="text"/> Lavatory: <input type="text"/> Kitchen Sink: <input type="text"/> Kitchen Sink: <input type="text"/> Utility / Process Sink: <input type="text" value="1"/> Scrub Sink: <input type="text"/> Floor Sink: <input type="text"/>							Other Fixtures: <input type="checkbox"/> Shower <input type="checkbox"/> Tub <input type="checkbox"/> Ice Maker <input type="checkbox"/> Water Closet <input type="checkbox"/> Instantaneous Hot Water				<input type="checkbox"/> Eyewash Station <input type="checkbox"/> Eyewash/Shower Station <input type="checkbox"/> Emergency Shower <input type="checkbox"/> Flush Rim Sink <input type="checkbox"/> Floor Drain <input type="checkbox"/> Water Bottle Refill Station				<b>MED / NON-MED GASES</b> (Quantity) Oxygen: <input type="text"/> Medical Air: <input type="text"/> Medical Vacuum: <input type="text"/> Nitrous Oxide: <input type="text"/> CO2: <input type="text"/> AGSS: <input type="text"/> Nitrogen: <input type="text"/> Laboratory Air: <input type="text"/> Laboratory Vacuum: <input type="text"/> Utility Compressed Air: <input type="text"/>				
Plumbing Remarks: <input type="text"/>							Gas Remarks: <input type="text"/>												

---

# New Surrey Hospital & BC Cancer Centre

MINIMUM ROOM REQUIREMENTS

## **F. Medical Imaging**

---



**Appendix 1B Minimum Room Requirements**

Room Name:

Program Number(s):

1. F7.01	7.	13.	19.	25.	31.	37.	43.
2.	8.	14.	20.	26.	32.	38.	44.
3.	9.	15.	21.	27.	33.	39.	45.
4.	10.	16.	22.	28.	34.	40.	46.
5.	11.	17.	23.	29.	35.	41.	47.
6.	12.	18.	24.	30.	36.	42.	48.

**ARCHITECTURAL REQUIREMENTS**

<b>WALL AND CEILING</b> Wall Material: <input type="text" value="ARGB 1.2m AFF, GB above"/> Finish: <input type="text" value="PT"/> Ceiling Material: <input type="text" value="ACT"/> Finish: <input type="text" value="PF"/>		<b>WALL PROTECTION</b> Type: <input type="text" value="PVW"/> <input checked="" type="checkbox"/> Corner Guards <input type="checkbox"/> Hand Rails <input type="checkbox"/> Bed Bumper / Locator Height: <input type="text" value="2185 mm"/> <input type="checkbox"/> Crash Rails <input type="checkbox"/> Chair Rail		<b>GLAZING</b> <input type="checkbox"/> Interior Glazing		<b>FLOORING TYPES</b> Material: <input type="text" value="VSF"/> Base: <input type="text" value="FCB"/>		<b>ROOM ACCESSORIES</b> <input type="checkbox"/> Coat Hooks <input type="checkbox"/> Ceiling Lift <input type="checkbox"/> Magnetic Whiteboard <input type="checkbox"/> Mirror <input type="checkbox"/> Infant Change Table <input type="checkbox"/> Privacy Curtain	
--	--	---	--	---	--	--	--	--	--

- LEGEND:**
- WALL AND CEILING LEGEND:**
- AC Architectural Ceiling
  - ACT Acoustic Ceiling Tile
  - ACT-C Cleanroom
  - ARGB Abuse-Resistant Gypsum Board
  - GB Gypsum Board
  - IRGB Impact-Resistant Gypsum Board
  - KLCT Kitchen Lay-in Ceiling Tile
  - MMRGB Moisture and Mould-Resistant Gypsum Board
  - SACT Security Acoustic Ceiling Tile
- WALL FINISHES LEGEND:**
- EWC Epoxy Wall Coating
  - HPC High Performance Coating
  - PT Paint
- CEILING FINISHES LEGEND:**
- ECC Epoxy Ceiling Coating
  - HPC High Performance Coating
  - PF Prefinished
  - PT Paint
- WALL PROTECTION LEGEND:**
- ESRP Extruded Semi-Rigid PVCu Panel
  - FRL Fibre Reinforced Laminate
  - FRP Fibreglass Reinforced Plastic
  - PVW Protective Vinyl Wallcovering
  - RHIS Rigid High Impact Sheet
  - WSSP Wetwall Solid Surface Panel
  - WVV Wetroom Vinyl Wallcovering
- FLOOR FINISHES LEGEND:**
- CFS Concrete Floor Sealer
  - EFC Epoxy Floor Coating
  - PFC Polyurethane Floor Coating
  - RAF Rubber Athletic Flooring
  - RSF Rubber Sheet Flooring
  - SCF Seamless Cushioned Flooring
  - SDRF Static-Dissipative Rubber Sheet Flooring
  - SDVF Static-Dissipative Vinyl Sheet Flooring
  - VSF Vinyl Sheet Flooring
  - WSVF Wetroom Safety Vinyl Sheet Flooring
- FLOOR BASE LEGEND:**
- FCB Flash Cove Base
  - RB Rubber Base
  - SCF Seamless Cushioned Flooring

**DOORS**

Types:

Type:Qty:	Size (mm):	Material:	Finish:	Side Lt:	Blinds:	Protect.:	Privacy Film:	Function:	Card Reader:	Mag Lock:	Auto Opener:	Hold Open:	Hinges:	Accessory 1:	Accessory 2:	Accessory 3:	Closer:

Door Remarks:  Security Grille  Anti-barricade strategy

**MILLWORK AND SPECIALTY CASEWORK**

Storage Requirements:

**UPPER UNITS** (U1-U8) **SHELF** (S1)

**FULL-HEIGHT CABINETS** (C1-C5, L1-L9)

**LOWER UNITS** (L10-L12) **RECEPTION/TRANSACTION COUNTER / CARE TEAM STATION DESK** (TC1, TC2) **UTILITY SINK AND COUNTER UNIT** (UC1)

**Legend:**

Category	Min. Length (mm)	Motorized Adjustable Height	Standing Height	Specialty Casework
3	1800	<input type="checkbox"/>	<input type="checkbox"/>	<input type="checkbox"/>

**FINISHES**

Full-height Cabinet:

Upper Millwork:

Countertop:

Lower Millwork:

Shelf:

Remarks:

**MECHANICAL REQUIREMENTS**

**PLUMBING**

Hand Hygiene Sink:	Lavatory:	Kitchen Sink:	Seamless Kitchen Sink:	Utility / Process Sink:	Scrub Sink:	Floor Sink:
<input type="text"/>	<input type="text"/>	<input type="text"/>	<input type="text"/>	<input type="text"/>	<input type="text"/>	<input type="text"/>

Plumbing Remarks:

**Other Fixtures:**

- Shower
- Tub
- Ice Maker
- Water Closet
- Instantaneous Hot Water
- Eyewash Station
- Eyewash/Shower Station
- Emergency Shower
- Flush Rim Sink
- Floor Drain
- Water Bottle Refill Station

Other:

**MED / NON-MED GASES**

Oxygen:	Medical Air:	Medical Vacuum:	Nitrous Oxide:	CO2:	AGSS:	Nitrogen:	Laboratory Air:	Laboratory Vacuum:	Utility Compressed Air:
<input type="text"/>	<input type="text"/>	<input type="text"/>	<input type="text"/>	<input type="text"/>	<input type="text"/>	<input type="text"/>	<input type="text"/>	<input type="text"/>	<input type="text"/>

Gas Remarks:

**Appendix 1B Minimum Room Requirements**

Room Name:

Program Number(s):

1. F4.13	7.	13.	19.	25.	31.	37.	43.
2. F5.13	8.	14.	20.	26.	32.	38.	44.
3.	9.	15.	21.	27.	33.	39.	45.
4.	10.	16.	22.	28.	34.	40.	46.
5.	11.	17.	23.	29.	35.	41.	47.
6.	12.	18.	24.	30.	36.	42.	48.

**ARCHITECTURAL REQUIREMENTS**

<b>WALL AND CEILING</b> Wall Material: <input type="text" value="ARGB 1.2m AFF, GB above"/> Finish: <input type="text" value="PT"/> Ceiling Material: <input type="text" value="ACT"/> Finish: <input type="text" value="PF"/>		<b>WALL PROTECTION</b> Type: <input type="text" value="PVW"/> <input checked="" type="checkbox"/> Corner Guards <input type="checkbox"/> Hand Rails <input type="checkbox"/> Bed Bumper / Locator Height: <input type="text" value="2185 mm"/> <input type="checkbox"/> Crash Rails <input type="checkbox"/> Chair Rail		<b>GLAZING</b> <input type="checkbox"/> Interior Glazing		<b>FLOORING TYPES</b> Material: <input type="text" value="VSF"/> Base: <input type="text" value="FCB"/>		<b>ROOM ACCESSORIES</b> <input type="checkbox"/> Coat Hooks <input type="checkbox"/> Ceiling Lift <input type="checkbox"/> Magnetic Whiteboard <input type="checkbox"/> Mirror <input type="checkbox"/> Infant Change Table <input type="checkbox"/> Privacy Curtain	
--	--	---	--	---	--	--	--	--	--

- LEGEND:**
- WALL AND CEILING LEGEND:**
- AC Architectural Ceiling
  - ACT Acoustic Ceiling Tile
  - ACT-C Cleanroom
  - ARGB Abuse-Resistant Gypsum Board
  - GB Gypsum Board
  - IRGB Impact-Resistant Gypsum Board
  - KLCT Kitchen Lay-in Ceiling Tile
  - MMRGB Moisture and Mould-Resistant Gypsum Board
  - SACT Security Acoustic Ceiling Tile
- WALL FINISHES LEGEND:**
- EWC Epoxy Wall Coating
  - HPC High Performance Coating
  - PT Paint
- CEILING FINISHES LEGEND:**
- ECC Epoxy Ceiling Coating
  - HPC High Performance Coating
  - PF Prefinished
  - PT Paint
- WALL PROTECTION LEGEND:**
- ESRP Extruded Semi-Rigid PVCu Panel
  - FRL Fibre Reinforced Laminate
  - FRP Fibreglass Reinforced Plastic
  - PVW Protective Vinyl Wallcovering
  - RHIS Rigid High Impact Sheet
  - WSSP Wetwall Solid Surface Panel
  - WVV Wetroom Vinyl Wallcovering
- FLOOR FINISHES LEGEND:**
- CFS Concrete Floor Sealer
  - EFC Epoxy Floor Coating
  - PFC Polyurethane Floor Coating
  - RAF Rubber Athletic Flooring
  - RSF Rubber Sheet Flooring
  - SCF Seamless Cushioned Flooring
  - SDRF Static-Dissipative Rubber Sheet Flooring
  - SDVF Static-Dissipative Vinyl Sheet Flooring
  - VSF Vinyl Sheet Flooring
  - WSVF Wetroom Safety Vinyl Sheet Flooring
- FLOOR BASE LEGEND:**
- FCB Flash Cove Base
  - RB Rubber Base
  - SCF Seamless Cushioned Flooring

**DOORS**

Types:

Type	Qty	Size (mm)	Material	Finish	Side Lt.	Blinds	Protect.	Privacy Film	Function	Card Reader	Mag Lock	Auto Opener	Hold Open	Hinges	Accessory 1	Accessory 2	Accessory 3	Closer

Door Remarks:  Security Grille  Anti-barricade strategy

**MILLWORK AND SPECIALTY CASEWORK**

**UPPER UNITS** (U1-U8) **LOWER UNITS** (L1-L12) **RECEPTION/TRANSACTION COUNTER / CARE TEAM STATION DESK** (TC1-TC2) **UTILITY SINK AND COUNTER UNIT** (UC1)

Storage Requirements:

**FINISHES**

Full-height Cabinet:   
 Upper Millwork:   
 Countertop:   
 Lower Millwork:   
 Shelf:

Remarks:

**Legend:**

Category	Min. Length (mm)	Motorized Adjustable Height	Standing Height	Specialty Casework
Category 0 - None				
Category 1 - Low (1% - 4%)				
Category 2 - Med (5% - 9%)				
Category 3 - High (10% or Greater)				

**MECHANICAL REQUIREMENTS**

<b>PLUMBING</b> (Quantity) Hygiene Sink: <input type="text"/> Lavatory: <input type="text"/> Kitchen Sink: <input type="text"/> Seamless Kitchen Sink: <input type="text"/> Utility / Process Sink: <input type="text"/> Scrub Sink: <input type="text"/> Floor Sink: <input type="text"/>							Other Fixtures: <input type="checkbox"/> Shower <input type="checkbox"/> Eyewash Station <input type="checkbox"/> Tub <input type="checkbox"/> Eyewash/Shower Station <input type="checkbox"/> Ice Maker <input type="checkbox"/> Emergency Shower <input type="checkbox"/> Water Closet <input type="checkbox"/> Flush Rim Sink <input type="checkbox"/> Instantaneous Hot Water <input type="checkbox"/> Floor Drain <input type="checkbox"/> Water Bottle Refill Station Other: <input type="text"/>				<b>MED / NON-MED GASES</b> (Quantity) Oxygen: <input type="text"/> Medical Air: <input type="text"/> Medical Vacuum: <input type="text"/> Nitrous Oxide: <input type="text"/> CO2: <input type="text"/> AGSS: <input type="text"/> Nitrogen: <input type="text"/> Laboratory Air: <input type="text"/> Laboratory Vacuum: <input type="text"/> Utility Compressed Air: <input type="text"/>					
Plumbing Remarks: <input type="text"/>											Gas Remarks: <input type="text"/>					

**Appendix 1B Minimum Room Requirements**

Room Name:

Program Number(s):

1. F4.14	7.	13.	19.	25.	31.	37.	43.
2.	8.	14.	20.	26.	32.	38.	44.
3.	9.	15.	21.	27.	33.	39.	45.
4.	10.	16.	22.	28.	34.	40.	46.
5.	11.	17.	23.	29.	35.	41.	47.
6.	12.	18.	24.	30.	36.	42.	48.

**ARCHITECTURAL REQUIREMENTS**

<b>WALL AND CEILING</b> Wall Material: <input type="text" value="ARGB 1.2m AFF, GB above"/> Finish: <input type="text" value="PT"/> Ceiling Material: <input type="text" value="ACT"/> Finish: <input type="text" value="PF"/>	<b>WALL PROTECTION</b> Type: <input type="text" value="PVW"/> <input checked="" type="checkbox"/> Corner Guards <input type="checkbox"/> Hand Rails <input type="checkbox"/> Bed Bumper / Locator Height: <input type="text" value="2185 mm"/> <input checked="" type="checkbox"/> Crash Rails <input type="checkbox"/> Chair Rail	<b>GLAZING</b> <input type="checkbox"/> Interior Glazing	<b>FLOORING TYPES</b> Material: <input type="text" value="VSF"/> Base: <input type="text" value="FCB"/>	<b>ROOM ACCESSORIES</b> <input type="checkbox"/> Coat Hooks <input type="checkbox"/> Ceiling Lift <input type="checkbox"/> Magnetic Whiteboard <input type="checkbox"/> Mirror <input type="checkbox"/> Infant Change Table <input type="checkbox"/> Privacy Curtain
--	--	---	--	--

- LEGEND:**
- WALL AND CEILING LEGEND:**
- AC Architectural Ceiling
  - ACT Acoustic Ceiling Tile
  - ACT-C Cleanroom
  - ARGB Abuse-Resistant Gypsum Board
  - GB Gypsum Board
  - IRGB Impact-Resistant Gypsum Board
  - KLCT Kitchen Lay-in Ceiling Tile
  - MMRGB Moisture and Mould-Resistant Gypsum Board
  - SACT Security Acoustic Ceiling Tile
- WALL FINISHES LEGEND:**
- EWC Epoxy Wall Coating
  - HPC High Performance Coating
  - PT Paint
- CEILING FINISHES LEGEND:**
- ECC Epoxy Ceiling Coating
  - HPC High Performance Coating
  - PF Prefinished
  - PT Paint
- WALL PROTECTION LEGEND:**
- ESRP Extruded Semi-Rigid PVCu Panel
  - FRL Fibre Reinforced Laminate
  - FRP Fibreglass Reinforced Plastic
  - PVW Protective Vinyl Wallcovering
  - RHIS Rigid High Impact Sheet
  - WSSP Wetwall Solid Surface Panel
  - WVV Wetroom Vinyl Wallcovering
- FLOOR FINISHES LEGEND:**
- CFS Concrete Floor Sealer
  - EFC Epoxy Floor Coating
  - PFC Polyurethane Floor Coating
  - RAF Rubber Athletic Flooring
  - RSF Rubber Sheet Flooring
  - SCF Seamless Cushioned Flooring
  - SDRF Static-Dissipative Rubber Sheet Flooring
  - SDVF Static-Dissipative Vinyl Sheet Flooring
  - VSF Vinyl Sheet Flooring
  - WSVF Wetroom Safety Vinyl Sheet Flooring
- FLOOR BASE LEGEND:**
- FCB Flash Cove Base
  - RB Rubber Base
  - SCF Seamless Cushioned Flooring

**DOORS**

Types:

Type:Qty:	Size (mm):	Material:	Finish:	Side Lt:	Blinds:	Protect.:	Privacy Film:	Function:	Card Reader:	Mag Lock:	Auto Opener:	Hold Open:	Hinges:	Accessory 1:	Accessory 2:	Accessory 3:	Closer:

Door Remarks:  Security Grille  Anti-barricade strategy

**MILLWORK AND SPECIALTY CASEWORK**

Storage Requirements:

**UPPER UNITS** U1  U2  U3  U4  U5  U6  U7  U8

**LOWER UNITS** L10  L11  L12  L1  L2  L3  L4  L5  L6  L7  L8  L9

**FULL-HEIGHT CABINETS** C1  C2  C3  C4  C5

**RECEPTION/TRANSACTION COUNTER / CARE TEAM STATION DESK** TC1  TC2

**UTILITY SINK AND COUNTER UNIT** UC1

**SHELF** S1

**FINISHES**

Full-height Cabinet:

Upper Millwork:

Countertop:

Lower Millwork:

Shelf:

Remarks:

Category	Min. Length (mm)	Motorized Adjustable Height	Standing Height	Specialty Casework
3	1800	<input checked="" type="checkbox"/>	<input type="checkbox"/>	<input type="checkbox"/>

**Legend:**  
 Category 0 - None  
 Category 1 - Low (1% - 4%)  
 Category 2 - Med (5% - 9%)  
 Category 3 - High (10% or Greater)

**MECHANICAL REQUIREMENTS**

<b>PLUMBING</b> (Quantity) Hand Hygiene Sink: <input type="text" value="1"/> Lavatory: <input type="text"/> Kitchen Sink: <input type="text"/> Seamless Kitchen Sink: <input type="text"/> Utility / Process Sink: <input type="text"/> Scrub Sink: <input type="text"/> Floor Sink: <input type="text"/> Plumbing Remarks: <input type="text"/>	Other Fixtures: <input type="checkbox"/> Shower <input type="checkbox"/> Eyewash Station <input type="checkbox"/> Tub <input type="checkbox"/> Eyewash/Shower Station <input type="checkbox"/> Ice Maker <input type="checkbox"/> Emergency Shower <input type="checkbox"/> Water Closet <input type="checkbox"/> Flush Rim Sink <input type="checkbox"/> Instantaneous Hot Water <input type="checkbox"/> Floor Drain <input type="checkbox"/> <input type="checkbox"/> Water Bottle Refill Station Other <input type="text"/>	<b>MED / NON-MED GASES</b> (Quantity) Oxygen: <input type="text"/> Medical Air: <input type="text"/> Medical Vacuum: <input type="text"/> Nitrous Oxide: <input type="text"/> CO2: <input type="text"/> AGSS: <input type="text"/> Nitrogen: <input type="text"/> Laboratory Air: <input type="text"/> Laboratory Vacuum: <input type="text"/> Utility Compressed Air: <input type="text"/> Gas Remarks: <input type="text"/>
---	--	---



**Appendix 1B Minimum Room Requirements**

Room Name:

Program Number(s):

1. F5.05	7.	13.	19.	25.	31.	37.	43.
2.	8.	14.	20.	26.	32.	38.	44.
3.	9.	15.	21.	27.	33.	39.	45.
4.	10.	16.	22.	28.	34.	40.	46.
5.	11.	17.	23.	29.	35.	41.	47.
6.	12.	18.	24.	30.	36.	42.	48.

**ARCHITECTURAL REQUIREMENTS**

<b>WALL AND CEILING</b> Wall Material: <input type="text" value="ARGB 1.2m AFF, GB above"/> Finish: <input type="text" value="PT"/> Ceiling Material: <input type="text" value="ACT"/> Finish: <input type="text" value="PF"/>		<b>WALL PROTECTION</b> Type: <input type="text" value="PVW"/> <input type="checkbox"/> Corner Guards <input type="checkbox"/> Hand Rails <input type="checkbox"/> Bed Bumper / Locator Height: <input type="text" value="1600 mm"/> <input type="checkbox"/> Crash Rails <input type="checkbox"/> Chair Rail			<b>GLAZING</b> <input checked="" type="checkbox"/> Interior Glazing		<b>FLOORING TYPES</b> Material: <input type="text" value="VSF"/> Base: <input type="text" value="FCB"/>		<b>ROOM ACCESSORIES</b> <input checked="" type="checkbox"/> Coat Hooks <input checked="" type="checkbox"/> Ceiling Lift <input type="checkbox"/> Magnetic Whiteboard <input type="checkbox"/> Mirror <input type="checkbox"/> Infant Change Table <input checked="" type="checkbox"/> Privacy Curtain		
--	--	--	--	--	--	--	--	--	---	--	--

- LEGEND:**
- WALL AND CEILING LEGEND:**
- AC Architectural Ceiling
  - ACT Acoustic Ceiling Tile
  - ACT-C Cleanroom
  - ARGB Abuse-Resistant Gypsum Board
  - GB Gypsum Board
  - IRGB Impact-Resistant Gypsum Board
  - KLCT Kitchen Lay-in Ceiling Tile
  - MMRGB Moisture and Mould-Resistant Gypsum Board
  - SACT Security Acoustic Ceiling Tile
- WALL FINISHES LEGEND:**
- EWC Epoxy Wall Coating
  - HPC High Performance Coating
  - PT Paint
- CEILING FINISHES LEGEND:**
- ECC Epoxy Ceiling Coating
  - HPC High Performance Coating
  - PF Prefinished
  - PT Paint
- WALL PROTECTION LEGEND:**
- ESRP Extruded Semi-Rigid PVCu Panel
  - FRL Fibre Reinforced Laminate
  - FRP Fibreglass Reinforced Plastic
  - PVW Protective Vinyl Wallcovering
  - RHIS Rigid High Impact Sheet
  - WSSP Wetwall Solid Surface Panel
  - WVV Wetroom Vinyl Wallcovering
- FLOOR FINISHES LEGEND:**
- CFS Concrete Floor Sealer
  - EFC Epoxy Floor Coating
  - PFC Polyurethane Floor Coating
  - RAF Rubber Athletic Flooring
  - RSF Rubber Sheet Flooring
  - SCF Seamless Cushioned Flooring
  - SDRF Static-Dissipative Rubber Sheet Flooring
  - SDVF Static-Dissipative Vinyl Sheet Flooring
  - VSF Vinyl Sheet Flooring
  - WSVF Wetroom Safety Vinyl Sheet Flooring
- FLOOR BASE LEGEND:**
- FCB Flash Cove Base
  - RB Rubber Base
  - SCF Seamless Cushioned Flooring

**DOORS**

Types:

Type	Qty	Size (mm)	Material	Finish	Side Lt.	Blinds	Protect.	Privacy Film	Function	Card Reader	Mag Lock	Auto Opener	Hold Open	Hinges	Accessory 1	Accessory 2	Accessory 3	Closer

Door Remarks:  Security Grille  Anti-barricade strategy

**MILLWORK AND SPECIALTY CASEWORK**

**UPPER UNITS** (U1-U8) **LOWER UNITS** (L1-L9)

**RECEPTION/TRANSACTION COUNTER / CARE TEAM STATION DESK** (TC1, TC2)

**UTILITY SINK AND COUNTER UNIT** (UC1)

**Storage Requirements:**  SHELF (S1)

**FINISHES**

Full-height Cabinet:   
 Upper Millwork:   
 Countertop:   
 Lower Millwork:   
 Shelf:

Remarks: Provide a fixed, modular partition room divider between recliners for infection control.

**MECHANICAL REQUIREMENTS**

<b>PLUMBING</b> (Quantity) Hygiene Sink: <input type="text" value="2"/> Lavatory: <input type="text"/> Kitchen Sink: <input type="text"/> Seamless Kitchen Sink: <input type="text"/> Utility / Process Sink: <input type="text"/> Scrub Sink: <input type="text"/> Floor Sink: <input type="text"/>							Other Fixtures: <input type="checkbox"/> Shower <input type="checkbox"/> Eyewash Station <input type="checkbox"/> Tub <input type="checkbox"/> Eyewash/Shower Station <input type="checkbox"/> Ice Maker <input type="checkbox"/> Emergency Shower <input type="checkbox"/> Water Closet <input type="checkbox"/> Flush Rim Sink <input type="checkbox"/> Instantaneous Hot Water <input type="checkbox"/> Floor Drain <input type="checkbox"/> Water Bottle Refill Station Other: <input type="text"/>				<b>MED / NON-MED GASES</b> (Quantity) Oxygen: <input type="text" value="1"/> Medical Air: <input type="text" value="1"/> Medical Vacuum: <input type="text" value="1"/> Nitrous Oxide: <input type="text"/> CO2: <input type="text"/> AGSS: <input type="text"/> Nitrogen: <input type="text"/> Laboratory Air: <input type="text"/> Laboratory Vacuum: <input type="text"/> Utility Compressed Air: <input type="text"/>					
Plumbing Remarks: <input type="text" value="Provide (2) HHS to serve (5) bays"/>											Gas Remarks: <input type="text" value="Provide (1) set of medical gases per chair bay to Patient's right."/>					

**Appendix 1B Minimum Room Requirements**

Room Name:

Program Number(s):

1. F6.10	7.	13.	19.	25.	31.	37.	43.
2.	8.	14.	20.	26.	32.	38.	44.
3.	9.	15.	21.	27.	33.	39.	45.
4.	10.	16.	22.	28.	34.	40.	46.
5.	11.	17.	23.	29.	35.	41.	47.
6.	12.	18.	24.	30.	36.	42.	48.

**ARCHITECTURAL REQUIREMENTS**

<b>WALL AND CEILING</b> Wall Material: <input type="text" value="ARGB 1.2m AFF, GB above"/> Finish: <input type="text" value="PT"/> Ceiling Material: <input type="text" value="ACT"/> Finish: <input type="text" value="PF"/>		<b>WALL PROTECTION</b> Type: <input type="text" value="RHIS"/> <input checked="" type="checkbox"/> Corner Guards <input type="checkbox"/> Hand Rails <input type="checkbox"/> Bed Bumper / Locator Height: <input type="text" value="1350 mm"/> <input type="checkbox"/> Crash Rails <input type="checkbox"/> Chair Rail		<b>GLAZING</b> <input type="checkbox"/> Interior Glazing		<b>FLOORING TYPES</b> Material: <input type="text" value="SDVF"/> Base: <input type="text" value="FCB"/>		<b>ROOM ACCESSORIES</b> <input type="checkbox"/> Coat Hooks <input type="checkbox"/> Ceiling Lift <input type="checkbox"/> Magnetic Whiteboard <input type="checkbox"/> Mirror <input type="checkbox"/> Infant Change Table <input type="checkbox"/> Privacy Curtain	
--	--	--	--	---	--	---	--	--	--

- LEGEND:**
- WALL AND CEILING LEGEND:**
- AC Architectural Ceiling
  - ACT Acoustic Ceiling Tile
  - ACT-C Cleanroom
  - ARGB Abuse-Resistant Gypsum Board
  - GB Gypsum Board
  - IRGB Impact-Resistant Gypsum Board
  - KLCT Kitchen Lay-in Ceiling Tile
  - MMRGB Moisture and Mould-Resistant Gypsum Board
  - SACT Security Acoustic Ceiling Tile
- WALL FINISHES LEGEND:**
- EWC Epoxy Wall Coating
  - HPC High Performance Coating
  - PT Paint
- CEILING FINISHES LEGEND:**
- ECC Epoxy Ceiling Coating
  - HPC High Performance Coating
  - PF Prefinished
  - PT Paint
- WALL PROTECTION LEGEND:**
- ESRP Extruded Semi-Rigid PVCu Panel
  - FRL Fibre Reinforced Laminate
  - FRP Fibreglass Reinforced Plastic
  - PVV Protective Vinyl Wallcovering
  - RHIS Rigid High Impact Sheet
  - WSSP Wetwall Solid Surface Panel
  - WVV Wetroom Vinyl Wallcovering
- FLOOR FINISHES LEGEND:**
- CFS Concrete Floor Sealer
  - EFC Epoxy Floor Coating
  - PFC Polyurethane Floor Coating
  - RAF Rubber Athletic Flooring
  - RSF Rubber Sheet Flooring
  - SCF Seamless Cushioned Flooring
  - SDRF Static-Dissipative Rubber Sheet Flooring
  - SDVF Static-Dissipative Vinyl Sheet Flooring
  - VSF Vinyl Sheet Flooring
  - WSVF Wetroom Safety Vinyl Sheet Flooring
- FLOOR BASE LEGEND:**
- FCB Flash Cove Base
  - RB Rubber Base
  - SCF Seamless Cushioned Flooring

**DOORS**

Types:

Type	Qty	Size (mm)	Material	Finish	Side Lt	Blinds	Protect	Privacy Film	Function	Card Reader	Mag Lock	Auto Opener	Hold Open	Hinges	Accessory 1	Accessory 2	Accessory 3	Closer
A	1	1220 x 2135	Solid Core	FRL	<input type="checkbox"/>	<input type="checkbox"/>	1 Low	<input type="checkbox"/>	Storeroom	<input checked="" type="checkbox"/>	<input type="checkbox"/>	<input type="checkbox"/>	<input checked="" type="checkbox"/>	Butt Hinge				Surface

Door Remarks:  Security Grille  Anti-barricade strategy



**MECHANICAL REQUIREMENTS**

<b>PLUMBING</b> (Quantity) Hand Hygiene Sink: <input type="text"/> Lavatory: <input type="text"/> Kitchen Sink: <input type="text"/> Seamless Kitchen Sink: <input type="text"/> Utility / Process Sink: <input type="text"/> Scrub Sink: <input type="text"/> Floor Sink: <input type="text"/>							Other Fixtures: <input type="checkbox"/> Shower <input type="checkbox"/> Eyewash Station <input type="checkbox"/> Tub <input type="checkbox"/> Eyewash/Shower Station <input type="checkbox"/> Ice Maker <input type="checkbox"/> Emergency Shower <input type="checkbox"/> Water Closet <input type="checkbox"/> Flush Rim Sink <input type="checkbox"/> Instantaneous Hot Water <input type="checkbox"/> Floor Drain <input type="checkbox"/> Water Bottle Refill Station Other: <input type="text"/>				<b>MED / NON-MED GASES</b> (Quantity) Oxygen: <input type="text"/> Medical Air: <input type="text"/> Medical Vacuum: <input type="text"/> Nitrous Oxide: <input type="text"/> CO2: <input type="text"/> AGSS: <input type="text"/> Nitrogen: <input type="text"/> Laboratory Air: <input type="text"/> Laboratory Vacuum: <input type="text"/> Utility Compressed Air: <input type="text"/>					
Plumbing Remarks: <input type="text"/>											Gas Remarks: <input type="text"/>					

**Appendix 1B Minimum Room Requirements**

Room Name:

Program Number(s):

1. F4.11	7.	13.	19.	25.	31.	37.	43.
2.	8.	14.	20.	26.	32.	38.	44.
3.	9.	15.	21.	27.	33.	39.	45.
4.	10.	16.	22.	28.	34.	40.	46.
5.	11.	17.	23.	29.	35.	41.	47.
6.	12.	18.	24.	30.	36.	42.	48.

**ARCHITECTURAL REQUIREMENTS**

<b>WALL AND CEILING</b> Wall Material: <input type="text" value="ARGB 1.2m AFF, GB above"/> Finish: <input type="text" value="PT"/> Ceiling Material: <input type="text" value="ACT"/> Finish: <input type="text" value="PF"/>	<b>WALL PROTECTION</b> Type: <input type="text" value="FRP"/> <input checked="" type="checkbox"/> Corner Guards <input type="checkbox"/> Hand Rails <input type="checkbox"/> Bed Bumper / Locator Height: <input type="text" value="1600 mm"/> <input type="checkbox"/> Crash Rails <input checked="" type="checkbox"/> Chair Rail	<b>GLAZING</b> <input checked="" type="checkbox"/> Interior Glazing	<b>FLOORING TYPES</b> Material: <input type="text" value="SDVF"/> Base: <input type="text" value="FCB"/>	<b>ROOM ACCESSORIES</b> <input type="checkbox"/> Coat Hooks <input type="checkbox"/> Ceiling Lift <input checked="" type="checkbox"/> Magnetic Whiteboard <input type="checkbox"/> Mirror <input type="checkbox"/> Infant Change Table <input type="checkbox"/> Privacy Curtain
--	--	--	---	---

- LEGEND:**
- WALL AND CEILING LEGEND:**
- AC Architectural Ceiling
  - ACT Acoustic Ceiling Tile
  - ACT-C Cleanroom
  - ARGB Abuse-Resistant Gypsum Board
  - GB Gypsum Board
  - IRGB Impact-Resistant Gypsum Board
  - KLCT Kitchen Lay-in Ceiling Tile
  - MMRGB Moisture and Mould-Resistant Gypsum Board
  - SACT Security Acoustic Ceiling Tile
- WALL FINISHES LEGEND:**
- EWC Epoxy Wall Coating
  - HPC High Performance Coating
  - PT Paint
- CEILING FINISHES LEGEND:**
- ECC Epoxy Ceiling Coating
  - HPC High Performance Coating
  - PF Prefinished
  - PT Paint
- WALL PROTECTION LEGEND:**
- ESRP Extruded Semi-Rigid PVCu Panel
  - FRL Fibre Reinforced Laminate
  - FRP Fibreglass Reinforced Plastic
  - PVV Protective Vinyl Wallcovering
  - RHIS Rigid High Impact Sheet
  - WSSP Wetwall Solid Surface Panel
  - WVV Wetroom Vinyl Wallcovering
- FLOOR FINISHES LEGEND:**
- CFS Concrete Floor Sealer
  - EFC Epoxy Floor Coating
  - PFC Polyurethane Floor Coating
  - RAF Rubber Athletic Flooring
  - RSF Rubber Sheet Flooring
  - SCF Seamless Cushioned Flooring
  - SDRF Static-Dissipative Rubber Sheet Flooring
  - SDVF Static-Dissipative Vinyl Sheet Flooring
  - VSF Vinyl Sheet Flooring
  - WSVF Wetroom Safety Vinyl Sheet Flooring
- FLOOR BASE LEGEND:**
- FCB Flash Cove Base
  - RB Rubber Base
  - SCF Seamless Cushioned Flooring

**DOORS**

Types:

Type	Qty	Size (mm)	Material	Finish	Side Lt.	Blinds	Protect.	Privacy Film	Function	Card Reader	Mag Lock	Auto Opener	Hold Open	Hinges	Accessory 1	Accessory 2	Accessory 3	Closer
B	2	1065 x 2135	Solid Core	FRL	<input type="checkbox"/>	<input type="checkbox"/>	1 Low	<input type="checkbox"/>	Passage	<input type="checkbox"/>	<input type="checkbox"/>	<input type="checkbox"/>	<input type="checkbox"/>	Butt Hinge				Surface
C	1	1065 x 2135	Solid Core	FRL	<input type="checkbox"/>	<input type="checkbox"/>	1 Low	<input type="checkbox"/>	Storeroom	<input checked="" type="checkbox"/>	<input type="checkbox"/>	<input type="checkbox"/>	<input type="checkbox"/>	Butt Hinge				Surface

Door Remarks: Preference is for design to not require doors from control room to imaging room. If internal doors are required, doors need to be shielded.

Security Grille  
 Anti-barricade strategy

**MILLWORK AND SPECIALTY CASEWORK**

Storage Requirements:

**UPPER UNITS** (U1-U8)

**LOWER UNITS** (L1-L12)

**RECEPTION/TRANSACTION COUNTER / CARE TEAM STATION DESK** (TC1, TC2)

**UTILITY SINK AND COUNTER UNIT** (UC1)

**SHelf** (S1)

**Full-height Cabinets** (C1-C5)

**Legend:**

Category	Min. Length (mm)	Motorized Adjustable Height	Standing Height	Specialty Casework
Category 0 - None				
Category 1 - Low (1% - 4%)				
Category 2 - Med (5% - 9%)				
Category 3 - High (10% or Greater)	3	2700	<input type="checkbox"/>	<input type="checkbox"/>

**FINISHES**

Full-height Cabinet:

Upper Millwork:

Countertop:

Lower Millwork:

Shelf:

Remarks:

**MECHANICAL REQUIREMENTS**

<b>PLUMBING</b> (Quantity) Hand Hygiene Sink: <input type="text" value="1"/> Lavatory: <input type="text"/> Kitchen Sink: <input type="text"/> Seamless Kitchen Sink: <input type="text"/> Utility / Process Sink: <input type="text"/> Scrub Sink: <input type="text"/> Floor Sink: <input type="text"/> Plumbing Remarks: <input type="text"/>	Other Fixtures: <input type="checkbox"/> Shower <input type="checkbox"/> Tub <input type="checkbox"/> Ice Maker <input type="checkbox"/> Water Closet <input type="checkbox"/> Instantaneous Hot Water <input type="checkbox"/> Eyewash Station <input type="checkbox"/> Eyewash/Shower Station <input type="checkbox"/> Emergency Shower <input type="checkbox"/> Flush Rim Sink <input type="checkbox"/> Floor Drain <input type="checkbox"/> Water Bottle Refill Station Other: <input type="text"/>	<b>MED / NON-MED GASES</b> (Quantity) Oxygen: <input type="text"/> Medical Air: <input type="text"/> Medical Vacuum: <input type="text"/> Nitrous Oxide: <input type="text"/> CO2: <input type="text"/> AGSS: <input type="text"/> Nitrogen: <input type="text"/> Laboratory Air: <input type="text"/> Laboratory Vacuum: <input type="text"/> Utility Compressed Air: <input type="text"/> Gas Remarks: <input type="text"/>
--	--	---



# Appendix 1B Minimum Room Requirements

Room Name:

Program Number(s):

1. F6.09	7.	13.	19.	25.	31.	37.	43.
2.	8.	14.	20.	26.	32.	38.	44.
3.	9.	15.	21.	27.	33.	39.	45.
4.	10.	16.	22.	28.	34.	40.	46.
5.	11.	17.	23.	29.	35.	41.	47.
6.	12.	18.	24.	30.	36.	42.	48.

## ARCHITECTURAL REQUIREMENTS

<b>WALL AND CEILING</b> Wall Material: <input type="text" value="ARGB 1.2m AFF, GB above"/> Finish: <input type="text" value="PT"/> Ceiling Material: <input type="text" value="ACT"/> Finish: <input type="text" value="PF"/>	<b>WALL PROTECTION</b> Type: <input type="text" value="FRP"/> <input checked="" type="checkbox"/> Corner Guards <input type="checkbox"/> Hand Rails <input type="checkbox"/> Bed Bumper / Locator Height: <input type="text" value="1600 mm"/> <input type="checkbox"/> Crash Rails <input checked="" type="checkbox"/> Chair Rail	<b>GLAZING</b> <input checked="" type="checkbox"/> Interior Glazing	<b>FLOORING TYPES</b> Material: <input type="text" value="SDVF"/> Base: <input type="text" value="FCB"/>	<b>ROOM ACCESSORIES</b> <input checked="" type="checkbox"/> Coat Hooks <input type="checkbox"/> Ceiling Lift <input checked="" type="checkbox"/> Magnetic Whiteboard <input type="checkbox"/> Mirror <input type="checkbox"/> Infant Change Table <input type="checkbox"/> Privacy Curtain
--	--	--	---	--

- LEGEND:**
- WALL AND CEILING LEGEND:**
- AC Architectural Ceiling
  - ACT Acoustic Ceiling Tile
  - ACT-C Cleanroom
  - ARGB Abuse-Resistant Gypsum Board
  - GB Gypsum Board
  - IRGB Impact-Resistant Gypsum Board
  - KLCT Kitchen Lay-in Ceiling Tile
  - MMRGB Moisture and Mould-Resistant Gypsum Board
  - SACT Security Acoustic Ceiling Tile
- WALL FINISHES LEGEND:**
- EWC Epoxy Wall Coating
  - HPC High Performance Coating
  - PT Paint
- CEILING FINISHES LEGEND:**
- ECC Epoxy Ceiling Coating
  - HPC High Performance Coating
  - PF Prefinished
  - PT Paint
- WALL PROTECTION LEGEND:**
- ESRP Extruded Semi-Rigid PVCu Panel
  - FRL Fibre Reinforced Laminate
  - FRP Fibreglass Reinforced Plastic
  - PVV Protective Vinyl Wallcovering
  - RHIS Rigid High Impact Sheet
  - WSSP Wetwall Solid Surface Panel
  - WVV Wetroom Vinyl Wallcovering
- FLOOR FINISHES LEGEND:**
- CFS Concrete Floor Sealer
  - EFC Epoxy Floor Coating
  - PFC Polyurethane Floor Coating
  - RAF Rubber Athletic Flooring
  - RSF Rubber Sheet Flooring
  - SCF Seamless Cushioned Flooring
  - SDRF Static-Dissipative Rubber Sheet Flooring
  - SDVF Static-Dissipative Vinyl Sheet Flooring
  - VSF Vinyl Sheet Flooring
  - WSVF Wetroom Safety Vinyl Sheet Flooring
- FLOOR BASE LEGEND:**
- FCB Flash Cove Base
  - RB Rubber Base
  - SCF Seamless Cushioned Flooring

**DOORS**

Types:

Type	Qty	Size (mm)	Material	Finish	Side Lt.	Blinds	Protect.	Privacy Film	Function	Card Reader	Mag Lock	Auto Opener	Hold Open	Hinges	Accessory 1	Accessory 2	Accessory 3	Closer
B	1	915 x 2135	Solid Core	FRL	<input type="checkbox"/>	<input type="checkbox"/>	1 Low	<input type="checkbox"/>	Passage	<input type="checkbox"/>	<input type="checkbox"/>	<input type="checkbox"/>	<input type="checkbox"/>	Butt Hinge				Surface

Door Remarks:  Security Grille  Anti-barricade strategy

**MILLWORK AND SPECIALTY CASEWORK**

Storage Requirements:

**UPPER UNITS** (U1-U8)

**LOWER UNITS** (L1-L9)

**RECEPTION/TRANSACTION COUNTER / CARE TEAM STATION DESK** (TC1, TC2)

**UTILITY SINK AND COUNTER UNIT** (UC1)

**SHELF** (S1)

**FULL-HEIGHT CABINETS** (C1-C5)

**Legend:**

Category	Min. Length (mm)	Motorized Adjustable Height	Standing Height	Specialty Casework
3	2700	<input type="checkbox"/>	<input type="checkbox"/>	<input type="checkbox"/>

**FINISHES**

Full-height Cabinet:

Upper Millwork:

Countertop:

Lower Millwork:

Shelf:

Remarks:

## MECHANICAL REQUIREMENTS

**PLUMBING**

Hand Hygiene Sink:	Lavatory:	Kitchen Sink:	Seamless Kitchen Sink:	Utility / Process Sink:	Scrub Sink:	Floor Sink:
0						

Plumbing Remarks:

**Other Fixtures:**

- Shower
- Tub
- Ice Maker
- Water Closet
- Instantaneous Hot Water
- Eyewash Station
- Eyewash/Shower Station
- Emergency Shower
- Flush Rim Sink
- Floor Drain
- Water Bottle Refill Station

Other:

**MED / NON-MED GASES**

Oxygen:	Medical Air:	Medical Vacuum:	Nitrous Oxide:	CO2:	AGSS:	Nitrogen:	Laboratory Air:	Laboratory Vacuum:	Utility Compressed Air:

Gas Remarks:

**Appendix 1B Minimum Room Requirements**

Room Name:

Program Number(s):

1. F1.06	7.	13.	19.	25.	31.	37.	43.
2.	8.	14.	20.	26.	32.	38.	44.
3.	9.	15.	21.	27.	33.	39.	45.
4.	10.	16.	22.	28.	34.	40.	46.
5.	11.	17.	23.	29.	35.	41.	47.
6.	12.	18.	24.	30.	36.	42.	48.

**ARCHITECTURAL REQUIREMENTS**

<b>WALL AND CEILING</b> Wall Material: <input type="text" value="GB"/> Finish: <input type="text" value="PT"/> Ceiling Material: <input type="text" value="ACT"/> Finish: <input type="text" value="PF"/>	<b>WALL PROTECTION</b> Type: <input type="text"/> Height: <input type="text"/> <input checked="" type="checkbox"/> Corner Guards <input type="checkbox"/> Hand Rails <input type="checkbox"/> Bed Bumper / Locator <input type="checkbox"/> Crash Rails <input checked="" type="checkbox"/> Chair Rail	<b>GLAZING</b> <input checked="" type="checkbox"/> Interior Glazing	<b>FLOORING TYPES</b> Material: <input type="text" value="VSF"/> Base: <input type="text" value="FCB"/>	<b>ROOM ACCESSORIES</b> <input type="checkbox"/> Coat Hooks <input type="checkbox"/> Ceiling Lift <input checked="" type="checkbox"/> Magnetic Whiteboard <input type="checkbox"/> Mirror <input type="checkbox"/> Infant Change Table <input type="checkbox"/> Privacy Curtain
---	---	--	--	---

- LEGEND:**
- WALL AND CEILING LEGEND:**
- AC Architectural Ceiling
  - ACT Acoustic Ceiling Tile
  - ACT-C Cleanroom
  - ARGB Abuse-Resistant Gypsum Board
  - GB Gypsum Board
  - IRGB Impact-Resistant Gypsum Board
  - KLCT Kitchen Lay-in Ceiling Tile
  - MMRGB Moisture and Mould-Resistant Gypsum Board
  - SACT Security Acoustic Ceiling Tile
- WALL FINISHES LEGEND:**
- EWC Epoxy Wall Coating
  - HPC High Performance Coating
  - PT Paint
- CEILING FINISHES LEGEND:**
- ECC Epoxy Ceiling Coating
  - HPC High Performance Coating
  - PF Prefinished
  - PT Paint
- WALL PROTECTION LEGEND:**
- ESRP Extruded Semi-Rigid PVCu Panel
  - FRL Fibre Reinforced Laminate
  - FRP Fibreglass Reinforced Plastic
  - PVV Protective Vinyl Wallcovering
  - RHIS Rigid High Impact Sheet
  - WSSP Wetwall Solid Surface Panel
  - WVV Wetroom Vinyl Wallcovering
- FLOOR FINISHES LEGEND:**
- CFS Concrete Floor Sealer
  - EFC Epoxy Floor Coating
  - PFC Polyurethane Floor Coating
  - RAF Rubber Athletic Flooring
  - RSF Rubber Sheet Flooring
  - SCF Seamless Cushioned Flooring
  - SDRF Static-Dissipative Rubber Sheet Flooring
  - SDVF Static-Dissipative Vinyl Sheet Flooring
  - VSF Vinyl Sheet Flooring
  - WSVF Wetroom Safety Vinyl Sheet Flooring
- FLOOR BASE LEGEND:**
- FCB Flash Cove Base
  - RB Rubber Base
  - SCF Seamless Cushioned Flooring

**DOORS**

Types:

Type	Qty	Size (mm)	Material	Finish	Side Lt.	Blinds	Protect.	Privacy Film	Function	Card Reader	Mag Lock	Auto Opener	Hold Open	Hinges	Accessory 1	Accessory 2	Accessory 3	Closer
C	1	915 x 2135	Solid Core	FRL	<input checked="" type="checkbox"/>	<input type="checkbox"/>	1 Low	<input type="checkbox"/>	Storeroom	<input checked="" type="checkbox"/>	<input type="checkbox"/>	<input type="checkbox"/>	<input type="checkbox"/>	Butt Hinge				Surface

Door Remarks:

Security Grille  
 Anti-barricade strategy

**MILLWORK AND SPECIALTY CASEWORK**

Storage Requirements:

**UPPER UNITS** (U1-U8)

**LOWER UNITS** (L1-L12)

**RECEPTION/TRANSACTION COUNTER / CARE TEAM STATION DESK** (TC1, TC2)

**UTILITY SINK AND COUNTER UNIT** (UC1)

**SHELF** (S1)

**FULL-HEIGHT CABINETS** (C1-C5)

**Legend:**

Category	Min. Length (mm)	Motorized Adjustable Height	Standing Height	Specialty Casework
3	5100	<input type="checkbox"/>	<input type="checkbox"/>	<input type="checkbox"/>

**FINISHES**

Full-height Cabinet:

Upper Millwork:

Countertop:

Lower Millwork:

Shelf:

Remarks:

**MECHANICAL REQUIREMENTS**

<b>PLUMBING</b> (Quantity) Hand Hygiene Sink: <input type="text"/> Lavatory: <input type="text"/> Kitchen Sink: <input type="text"/> Seamless Kitchen Sink: <input type="text"/> Utility / Process Sink: <input type="text"/> Scrub Sink: <input type="text"/> Floor Sink: <input type="text"/> Plumbing Remarks: <input type="text"/>	Other Fixtures: <input type="checkbox"/> Shower <input type="checkbox"/> Tub <input type="checkbox"/> Ice Maker <input type="checkbox"/> Water Closet <input type="checkbox"/> Instantaneous Hot Water <input type="checkbox"/> Eyewash Station <input type="checkbox"/> Eyewash/Shower Station <input type="checkbox"/> Emergency Shower <input type="checkbox"/> Flush Rim Sink <input type="checkbox"/> Floor Drain <input type="checkbox"/> Water Bottle Refill Station Other: <input type="text"/>	<b>MED / NON-MED GASES</b> (Quantity) Oxygen: <input type="text"/> Medical Air: <input type="text"/> Medical Vacuum: <input type="text"/> Nitrous Oxide: <input type="text"/> CO2: <input type="text"/> AGSS: <input type="text"/> Nitrogen: <input type="text"/> Laboratory Air: <input type="text"/> Laboratory Vacuum: <input type="text"/> Utility Compressed Air: <input type="text"/> Gas Remarks: <input type="text"/>
--	--	---

**Appendix 1B Minimum Room Requirements**

Room Name:

Program Number(s):

1. F2.11	7.	13.	19.	25.	31.	37.	43.
2.	8.	14.	20.	26.	32.	38.	44.
3.	9.	15.	21.	27.	33.	39.	45.
4.	10.	16.	22.	28.	34.	40.	46.
5.	11.	17.	23.	29.	35.	41.	47.
6.	12.	18.	24.	30.	36.	42.	48.

**ARCHITECTURAL REQUIREMENTS**

<b>WALL AND CEILING</b> Wall Material: <input type="text" value="ARGB 1.2m AFF, GB above"/> Finish: <input type="text" value="PT"/> Ceiling Material: <input type="text" value="ACT"/> Finish: <input type="text" value="PF"/>		<b>WALL PROTECTION</b> Type: <input type="text" value="FRP"/> <input checked="" type="checkbox"/> Corner Guards <input type="checkbox"/> Hand Rails <input type="checkbox"/> Bed Bumper / Locator Height: <input type="text" value="1600 mm"/> <input type="checkbox"/> Crash Rails <input type="checkbox"/> Chair Rail		<b>GLAZING</b> <input type="checkbox"/> Interior Glazing		<b>FLOORING TYPES</b> Material: <input type="text" value="VSF"/> Base: <input type="text" value="FCB"/>		<b>ROOM ACCESSORIES</b> <input checked="" type="checkbox"/> Coat Hooks <input checked="" type="checkbox"/> Ceiling Lift <input checked="" type="checkbox"/> Magnetic Whiteboard <input type="checkbox"/> Mirror <input type="checkbox"/> Infant Change Table <input checked="" type="checkbox"/> Privacy Curtain	
--	--	---	--	---	--	--	--	--	--

- LEGEND:**
- WALL AND CEILING LEGEND:**
- AC Architectural Ceiling
  - ACT Acoustic Ceiling Tile
  - ACT-C Cleanroom
  - ARGB Abuse-Resistant Gypsum Board
  - GB Gypsum Board
  - IRGB Impact-Resistant Gypsum Board
  - KLCT Kitchen Lay-in Ceiling Tile
  - MMRGB Moisture and Mould-Resistant Gypsum Board
  - SACT Security Acoustic Ceiling Tile
- WALL FINISHES LEGEND:**
- EWC Epoxy Wall Coating
  - HPC High Performance Coating
  - PT Paint
- CEILING FINISHES LEGEND:**
- ECC Epoxy Ceiling Coating
  - HPC High Performance Coating
  - PF Prefinished
  - PT Paint
- WALL PROTECTION LEGEND:**
- ESRP Extruded Semi-Rigid PVCu Panel
  - FRL Fibre Reinforced Laminate
  - FRP Fibreglass Reinforced Plastic
  - PVV Protective Vinyl Wallcovering
  - RHIS Rigid High Impact Sheet
  - WSSP Wetwall Solid Surface Panel
  - WVV Wetroom Vinyl Wallcovering
- FLOOR FINISHES LEGEND:**
- CFS Concrete Floor Sealer
  - EFC Epoxy Floor Coating
  - PFC Polyurethane Floor Coating
  - RAF Rubber Athletic Flooring
  - RSF Rubber Sheet Flooring
  - SCF Seamless Cushioned Flooring
  - SDRF Static-Dissipative Rubber Sheet Flooring
  - SDVF Static-Dissipative Vinyl Sheet Flooring
  - VSF Vinyl Sheet Flooring
  - WSVF Wetroom Safety Vinyl Sheet Flooring
- FLOOR BASE LEGEND:**
- FCB Flash Cove Base
  - RB Rubber Base
  - SCF Seamless Cushioned Flooring

**DOORS**

Types:

Note: for Type F doors, the door panels will be approximately 465/1065 unless otherwise required by the Authority

Type	Qty	Size (mm)	Material	Finish	Side Lt.	Blinds	Protect.	Privacy Film	Function	Card Reader	Mag Lock	Auto Opener	Hold Open	Hinges	Accessory 1	Accessory 2	Accessory 3	Closer
F	1	1530 x 2135	Solid Core	FRL	<input type="checkbox"/>	<input type="checkbox"/>	2 High	<input type="checkbox"/>	Passage	<input type="checkbox"/>	<input type="checkbox"/>	<input type="checkbox"/>	<input type="checkbox"/>	Butt Hinge	Astragal	Flush Bolt		Concealed

**FINISHES**

Full-height Cabinet:

Upper Millwork:

Countertop:

Lower Millwork:

Shelf:

Remarks:

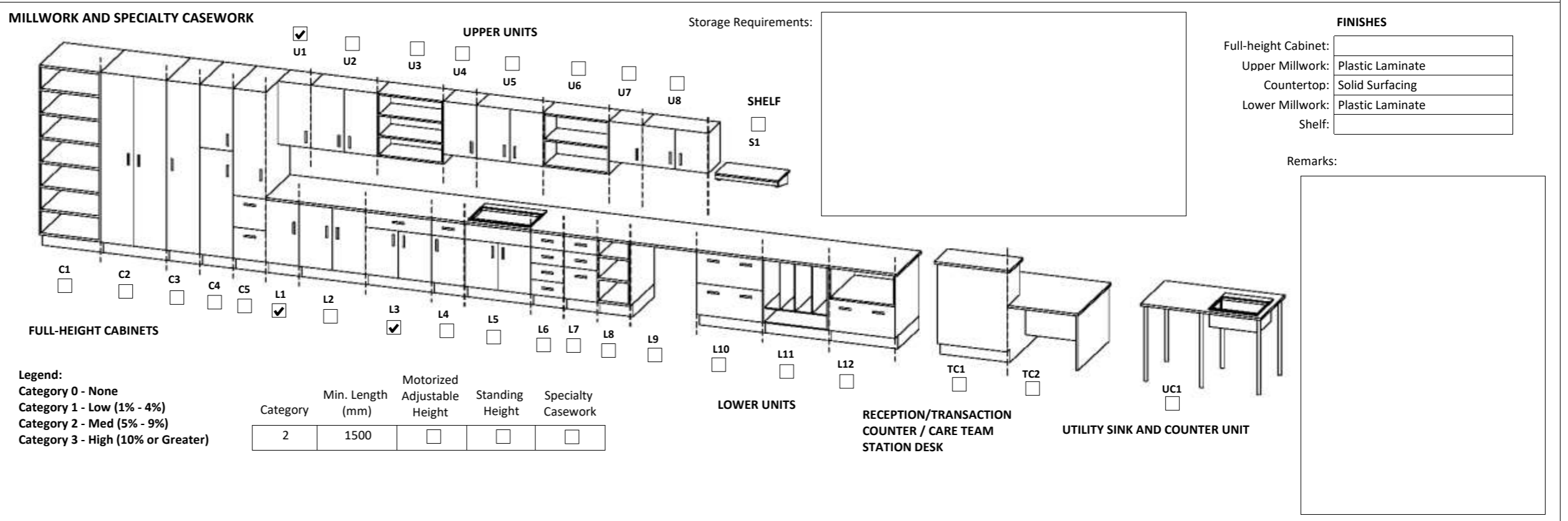

**MECHANICAL REQUIREMENTS**

<b>PLUMBING</b> (Quantity)		Hand Hygiene Sink: <input type="text" value="1"/> Lavatory: <input type="text"/> Kitchen Sink: <input type="text"/> Seamless Kitchen Sink: <input type="text"/> Utility / Process Sink: <input type="text"/> Scrub Sink: <input type="text"/> Floor Sink: <input type="text"/>							Other Fixtures: <input type="checkbox"/> Shower <input type="checkbox"/> Eyewash Station <input type="checkbox"/> Tub <input type="checkbox"/> Eyewash/Shower Station <input type="checkbox"/> Ice Maker <input type="checkbox"/> Emergency Shower <input type="checkbox"/> Water Closet <input type="checkbox"/> Flush Rim Sink <input type="checkbox"/> Instantaneous Hot Water <input type="checkbox"/> Floor Drain <input type="checkbox"/> Water Bottle Refill Station Other: <input type="text"/>				<b>MED / NON-MED GASES</b> (Quantity)						Laboratory Air: <input type="text"/> Laboratory Vacuum: <input type="text"/> Utility Compressed Air: <input type="text"/>	
Plumbing Remarks: <input type="text"/>		Oxygen: <input type="text" value="2"/> Medical Air: <input type="text" value="1"/> Medical Vacuum: <input type="text" value="1"/> Nitrous Oxide: <input type="text"/> CO2: <input type="text"/> AGSS: <input type="text"/> Nitrogen: <input type="text"/>		Gas Remarks: <input type="text"/>																



**Appendix 1B Minimum Room Requirements**

Room Name:

Program Number(s):

1. F3.08	7.	13.	19.	25.	31.	37.	43.
2.	8.	14.	20.	26.	32.	38.	44.
3.	9.	15.	21.	27.	33.	39.	45.
4.	10.	16.	22.	28.	34.	40.	46.
5.	11.	17.	23.	29.	35.	41.	47.
6.	12.	18.	24.	30.	36.	42.	48.

**ARCHITECTURAL REQUIREMENTS**

<b>WALL AND CEILING</b> Wall Material: <input type="text" value="ARGB 1.2m AFF, GB above"/> Finish: <input type="text" value="PT"/> Ceiling Material: <input type="text" value="ACT"/> Finish: <input type="text" value="PF"/>	<b>WALL PROTECTION</b> Type: <input type="text" value="FRP"/> <input checked="" type="checkbox"/> Corner Guards <input type="checkbox"/> Hand Rails <input type="checkbox"/> Bed Bumper / Locator Height: <input type="text" value="1600 mm"/> <input type="checkbox"/> Crash Rails <input type="checkbox"/> Chair Rail	<b>GLAZING</b> <input type="checkbox"/> Interior Glazing	<b>FLOORING TYPES</b> Material: <input type="text" value="VSF"/> Base: <input type="text" value="FCB"/>	<b>ROOM ACCESSORIES</b> <input checked="" type="checkbox"/> Coat Hooks <input type="checkbox"/> Ceiling Lift <input checked="" type="checkbox"/> Magnetic Whiteboard <input type="checkbox"/> Mirror <input type="checkbox"/> Infant Change Table <input checked="" type="checkbox"/> Privacy Curtain
--	---	---	--	---

- LEGEND:**
- WALL AND CEILING LEGEND:**
- AC Architectural Ceiling
  - ACT Acoustic Ceiling Tile
  - ACT-C Cleanroom
  - ARGB Abuse-Resistant Gypsum Board
  - GB Gypsum Board
  - IRGB Impact-Resistant Gypsum Board
  - KLCT Kitchen Lay-in Ceiling Tile
  - MMRGB Moisture and Mould-Resistant Gypsum Board
  - SACT Security Acoustic Ceiling Tile
- WALL FINISHES LEGEND:**
- EWC Epoxy Wall Coating
  - HPC High Performance Coating
  - PT Paint
- CEILING FINISHES LEGEND:**
- ECC Epoxy Ceiling Coating
  - HPC High Performance Coating
  - PF Prefinished
  - PT Paint
- WALL PROTECTION LEGEND:**
- ESRP Extruded Semi-Rigid PVCu Panel
  - FRL Fibre Reinforced Laminate
  - FRP Fibreglass Reinforced Plastic
  - PVV Protective Vinyl Wallcovering
  - RHIS Rigid High Impact Sheet
  - WSSP Wetwall Solid Surface Panel
  - WVV Wetroom Vinyl Wallcovering
- FLOOR FINISHES LEGEND:**
- CFS Concrete Floor Sealer
  - EFC Epoxy Floor Coating
  - PFC Polyurethane Floor Coating
  - RAF Rubber Athletic Flooring
  - RSF Rubber Sheet Flooring
  - SCF Seamless Cushioned Flooring
  - SDRF Static-Dissipative Rubber Sheet Flooring
  - SDVF Static-Dissipative Vinyl Sheet Flooring
  - VSF Vinyl Sheet Flooring
  - WSVF Wetroom Safety Vinyl Sheet Flooring
- FLOOR BASE LEGEND:**
- FCB Flash Cove Base
  - RB Rubber Base
  - SCF Seamless Cushioned Flooring

**DOORS**

Types:

Note: for Type F doors, the door panels will be approximately 465/1065 unless otherwise required by the Authority

Type	Qty	Size (mm)	Material	Finish	Side Lt.	Blinds	Protect.	Privacy Film	Function	Card Reader	Mag Lock	Auto Opener	Hold Open	Hinges	Accessory 1	Accessory 2	Accessory 3	Closer
F	1	1530 x 2135	Solid Core	FRL	<input type="checkbox"/>	<input type="checkbox"/>	2 High	<input type="checkbox"/>	Passage	<input type="checkbox"/>	<input type="checkbox"/>	<input type="checkbox"/>	<input type="checkbox"/>	Butt Hinge	Astragal	Flush Bolt		Concealed
A	1	1065 x 2135	Solid Core	FRL	<input type="checkbox"/>	<input type="checkbox"/>	1 Low	<input type="checkbox"/>	Passage	<input type="checkbox"/>	<input type="checkbox"/>	<input type="checkbox"/>	<input type="checkbox"/>	Butt Hinge				Concealed

**DOOR REMARKS:**

Security Grille  
 Anti-barricade strategy

**MILLWORK AND SPECIALTY CASEWORK**

Storage Requirements:

**UPPER UNITS:** U1, U2, U3, U4, U5, U6, U7, U8

**LOWER UNITS:** L1, L2, L3, L4, L5, L6, L7, L8, L9, L10, L11, L12

**RECEPTION/TRANSACTION COUNTER / CARE TEAM STATION DESK:** TC1, TC2

**UTILITY SINK AND COUNTER UNIT:** UC1

**SHELF:** S1

**FULL-HEIGHT CABINETS:** C1, C2, C3, C4, C5

**Legend:**

Category	Min. Length (mm)	Motorized Adjustable Height	Standing Height	Specialty Casework
3	3300	<input type="checkbox"/>	<input type="checkbox"/>	<input type="checkbox"/>

**FINISHES**

Full-height Cabinet:   
 Upper Millwork:   
 Countertop:   
 Lower Millwork:   
 Shelf:

**REMARKS:**

**MECHANICAL REQUIREMENTS**

<b>PLUMBING</b> (Quantity) Hand Hygiene Sink: <input type="text" value="1"/> Lavatory: <input type="text"/> Kitchen Sink: <input type="text"/> Seamless Kitchen Sink: <input type="text"/> Utility / Process Sink: <input type="text"/> Scrub Sink: <input type="text"/> Floor Sink: <input type="text"/> Plumbing Remarks: <input type="text"/>	Other Fixtures: <input type="checkbox"/> Shower <input type="checkbox"/> Tub <input type="checkbox"/> Ice Maker <input type="checkbox"/> Water Closet <input type="checkbox"/> Instantaneous Hot Water <input type="checkbox"/> Eyewash Station <input type="checkbox"/> Eyewash/Shower Station <input type="checkbox"/> Emergency Shower <input type="checkbox"/> Flush Rim Sink <input type="checkbox"/> Floor Drain <input type="checkbox"/> Water Bottle Refill Station Other: <input type="text"/>	<b>MED / NON-MED GASES</b> (Quantity) Oxygen: <input type="text" value="1"/> Medical Air: <input type="text" value="1"/> Medical Vacuum: <input type="text" value="1"/> Nitrous Oxide: <input type="text"/> CO2: <input type="text"/> AGSS: <input type="text"/> Nitrogen: <input type="text"/> Laboratory Air: <input type="text"/> Laboratory Vacuum: <input type="text"/> Utility Compressed Air: <input type="text"/> Gas Remarks: <input type="text"/>
---	---	---

**Appendix 1B Minimum Room Requirements**

Room Name:

Program Number(s):	1. F7.09	7.	13.	19.	25.	31.	37.	43.
	2.	8.	14.	20.	26.	32.	38.	44.
	3.	9.	15.	21.	27.	33.	39.	45.
	4.	10.	16.	22.	28.	34.	40.	46.
	5.	11.	17.	23.	29.	35.	41.	47.
	6.	12.	18.	24.	30.	36.	42.	48.

**ARCHITECTURAL REQUIREMENTS**

<b>WALL AND CEILING</b> Wall Material: <input type="text" value="ARGB 1.2m AFF, GB above"/> Finish: <input type="text" value="PT"/> Ceiling Material: <input type="text" value="ACT"/> Finish: <input type="text" value="PF"/>		<b>WALL PROTECTION</b> Type: <input type="text" value="FRP"/> <input checked="" type="checkbox"/> Corner Guards <input type="checkbox"/> Hand Rails <input type="checkbox"/> Bed Bumper / Locator Height: <input type="text" value="2185 mm"/> <input type="checkbox"/> Crash Rails <input type="checkbox"/> Chair Rail		<b>GLAZING</b> <input type="checkbox"/> Interior Glazing		<b>FLOORING TYPES</b> Material: <input type="text" value="VSF"/> Base: <input type="text" value="FCB"/>		<b>ROOM ACCESSORIES</b> <input type="checkbox"/> Coat Hooks <input type="checkbox"/> Ceiling Lift <input checked="" type="checkbox"/> Magnetic Whiteboard <input type="checkbox"/> Mirror <input type="checkbox"/> Infant Change Table <input type="checkbox"/> Privacy Curtain	
--	--	---	--	---	--	--	--	---	--

- LEGEND:**
- WALL AND CEILING LEGEND:**
- AC Architectural Ceiling
  - ACT Acoustic Ceiling Tile
  - ACT-C Cleanroom
  - ARGB Abuse-Resistant Gypsum Board
  - GB Gypsum Board
  - IRGB Impact-Resistant Gypsum Board
  - KLCT Kitchen Lay-in Ceiling Tile
  - MMRGB Moisture and Mould-Resistant Gypsum Board
  - SACT Security Acoustic Ceiling Tile
- WALL FINISHES LEGEND:**
- EWC Epoxy Wall Coating
  - HPC High Performance Coating
  - PT Paint
- CEILING FINISHES LEGEND:**
- ECC Epoxy Ceiling Coating
  - HPC High Performance Coating
  - PF Prefinished
  - PT Paint
- WALL PROTECTION LEGEND:**
- ESRP Extruded Semi-Rigid PVCu Panel
  - FRL Fibre Reinforced Laminate
  - FRP Fibreglass Reinforced Plastic
  - PVV Protective Vinyl Wallcovering
  - RHIS Rigid High Impact Sheet
  - WSSP Wetwall Solid Surface Panel
  - WVV Wetroom Vinyl Wallcovering
- FLOOR FINISHES LEGEND:**
- CFS Concrete Floor Sealer
  - EFC Epoxy Floor Coating
  - PFC Polyurethane Floor Coating
  - RAF Rubber Athletic Flooring
  - RSF Rubber Sheet Flooring
  - SCF Seamless Cushioned Flooring
  - SDRF Static-Dissipative Rubber Sheet Flooring
  - SDVF Static-Dissipative Vinyl Sheet Flooring
  - VSF Vinyl Sheet Flooring
  - WSVF Wetroom Safety Vinyl Sheet Flooring
- FLOOR BASE LEGEND:**
- FCB Flash Cove Base
  - RB Rubber Base
  - SCF Seamless Cushioned Flooring

**DOORS**

Types:

Note: for Type F doors, the door panels will be approximately 465/1065 unless otherwise required by the Authority

Door Remarks: Refer to Schedule 1, Section 6.13 (Division 13) for all lead sheet requirements

Security Grille  
 Anti-barricade strategy

Type	Qty	Size (mm)	Material	Finish	Side Lt.	Blinds	Protect.	Privacy Film	Function	Card Reader	Mag Lock	Auto Opener	Hold Open	Hinges	Accessory 1	Accessory 2	Accessory 3	Closer
F2	1	1530 x 2135	Hollow Metal	Paint	<input type="checkbox"/>	<input type="checkbox"/>		<input type="checkbox"/>	Storeroom	<input checked="" type="checkbox"/>	<input type="checkbox"/>	<input type="checkbox"/>	<input checked="" type="checkbox"/>	Butt Hinge	Astragal	Flush Bolt		Surface

**MILLWORK AND SPECIALTY CASEWORK**

Storage Requirements:

**UPPER UNITS** (U1-U8)

**LOWER UNITS** (L1-L12)

**RECEPTION/TRANSACTION COUNTER / CARE TEAM STATION DESK** (TC1, TC2)

**UTILITY SINK AND COUNTER UNIT** (UC1)

**SHELF** (S1)

**FULL-HEIGHT CABINETS** (C1-C5)

**FINISHES**

Full-height Cabinet:

Upper Millwork:

Countertop:

Lower Millwork:

Shelf:

Remarks:

Category	Min. Length (mm)	Motorized Adjustable Height	Standing Height	Specialty Casework
3	2400	<input type="checkbox"/>	<input checked="" type="checkbox"/>	<input type="checkbox"/>

**MECHANICAL REQUIREMENTS**

**PLUMBING**

(Quantity)

Hygiene Sink:	Lavatory:	Kitchen Sink:	Seamless Kitchen Sink:	Utility / Process Sink:	Scrub Sink:	Floor Sink:
<input type="text"/>	<input type="text"/>	<input type="text"/>	<input type="text"/>	<input type="text"/>	<input type="text"/>	<input type="text"/>

Plumbing Remarks:

**Other Fixtures:**

- Shower
- Tub
- Ice Maker
- Water Closet
- Instantaneous Hot Water
- Ewewash Station
- Eyewash/Shower Station
- Emergency Shower
- Flush Rim Sink
- Floor Drain
- Water Bottle Refill Station

Other:

**MED / NON-MED GASES**

(Quantity)

Oxygen:	Medical Air:	Medical Vacuum:	Nitrous Oxide:	CO2:	AGSS:	Nitrogen:	Laboratory Air:	Laboratory Vacuum:	Utility Compressed Air:
<input type="text"/>	<input type="text"/>	<input type="text"/>	<input type="text"/>	<input type="text"/>	<input type="text"/>	<input type="text"/>	<input type="text"/>	<input type="text"/>	<input type="text"/>

Gas Remarks:

**Appendix 1B Minimum Room Requirements**

Room Name:

Program Number(s):

1. F5.10	7.	13.	19.	25.	31.	37.	43.
2.	8.	14.	20.	26.	32.	38.	44.
3.	9.	15.	21.	27.	33.	39.	45.
4.	10.	16.	22.	28.	34.	40.	46.
5.	11.	17.	23.	29.	35.	41.	47.
6.	12.	18.	24.	30.	36.	42.	48.

**ARCHITECTURAL REQUIREMENTS**

<b>WALL AND CEILING</b> Wall Material: <input type="text" value="ARGB 1.2m AFF, GB above"/> Finish: <input type="text" value="PT"/> Ceiling Material: <input type="text" value="ACT"/> Finish: <input type="text" value="PF"/>	<b>WALL PROTECTION</b> Type: <input type="text" value="FRP"/> <input checked="" type="checkbox"/> Corner Guards <input type="checkbox"/> Hand Rails <input type="checkbox"/> Bed Bumper / Locator Height: <input type="text" value="1600 mm"/> <input type="checkbox"/> Crash Rails <input type="checkbox"/> Chair Rail	<b>GLAZING</b> <input checked="" type="checkbox"/> Interior Glazing	<b>FLOORING TYPES</b> Material: <input type="text" value="VSF"/> Base: <input type="text" value="FCB"/>	<b>ROOM ACCESSORIES</b> <input checked="" type="checkbox"/> Coat Hooks <input checked="" type="checkbox"/> Ceiling Lift <input checked="" type="checkbox"/> Magnetic Whiteboard <input type="checkbox"/> Mirror <input type="checkbox"/> Infant Change Table <input type="checkbox"/> Privacy Curtain
--	---	--	--	---

- LEGEND:**
- WALL AND CEILING LEGEND:**
- AC Architectural Ceiling
  - ACT Acoustic Ceiling Tile
  - ACT-C Cleanroom
  - ARGB Abuse-Resistant Gypsum Board
  - GB Gypsum Board
  - IRGB Impact-Resistant Gypsum Board
  - KLCT Kitchen Lay-in Ceiling Tile
  - MMRGB Moisture and Mould-Resistant Gypsum Board
  - SACT Security Acoustic Ceiling Tile
- WALL FINISHES LEGEND:**
- EWC Epoxy Wall Coating
  - HPC High Performance Coating
  - PT Paint
- CEILING FINISHES LEGEND:**
- ECC Epoxy Ceiling Coating
  - HPC High Performance Coating
  - PF Prefinished
  - PT Paint
- WALL PROTECTION LEGEND:**
- ESRP Extruded Semi-Rigid PVCu Panel
  - FRL Fibre Reinforced Laminate
  - FRP Fibreglass Reinforced Plastic
  - PVV Protective Vinyl Wallcovering
  - RHIS Rigid High Impact Sheet
  - WSSP Wetwall Solid Surface Panel
  - WVV Wetroom Vinyl Wallcovering
- FLOOR FINISHES LEGEND:**
- CFS Concrete Floor Sealer
  - EFC Epoxy Floor Coating
  - PFC Polyurethane Floor Coating
  - RAF Rubber Athletic Flooring
  - RSF Rubber Sheet Flooring
  - SCF Seamless Cushioned Flooring
  - SDRF Static-Dissipative Rubber Sheet Flooring
  - SDVF Static-Dissipative Vinyl Sheet Flooring
  - VSF Vinyl Sheet Flooring
  - WSVF Wetroom Safety Vinyl Sheet Flooring
- FLOOR BASE LEGEND:**
- FCB Flash Cove Base
  - RB Rubber Base
  - SCF Seamless Cushioned Flooring

**DOORS**

Types:

Note: for Type F doors, the door panels will be approximately 465/1065 unless otherwise required by the Authority

Door Remarks:

Security Grille  
 Anti-barricade strategy

Type	Qty	Size (mm)	Material	Finish	Side Lt.	Blinds	Protect.	Privacy Film	Function	Card Reader	Mag Lock	Auto Opener	Hold Open	Hinges	Accessory 1	Accessory 2	Accessory 3	Closer
F	1	1530 x 2135	Solid Core	FRL	<input type="checkbox"/>	<input type="checkbox"/>	2 High	<input type="checkbox"/>	Storeroom	<input checked="" type="checkbox"/>	<input type="checkbox"/>	<input checked="" type="checkbox"/>	<input checked="" type="checkbox"/>	Butt Hinge	Astragal	Flush Bolt	Elec. Strike	Concealed

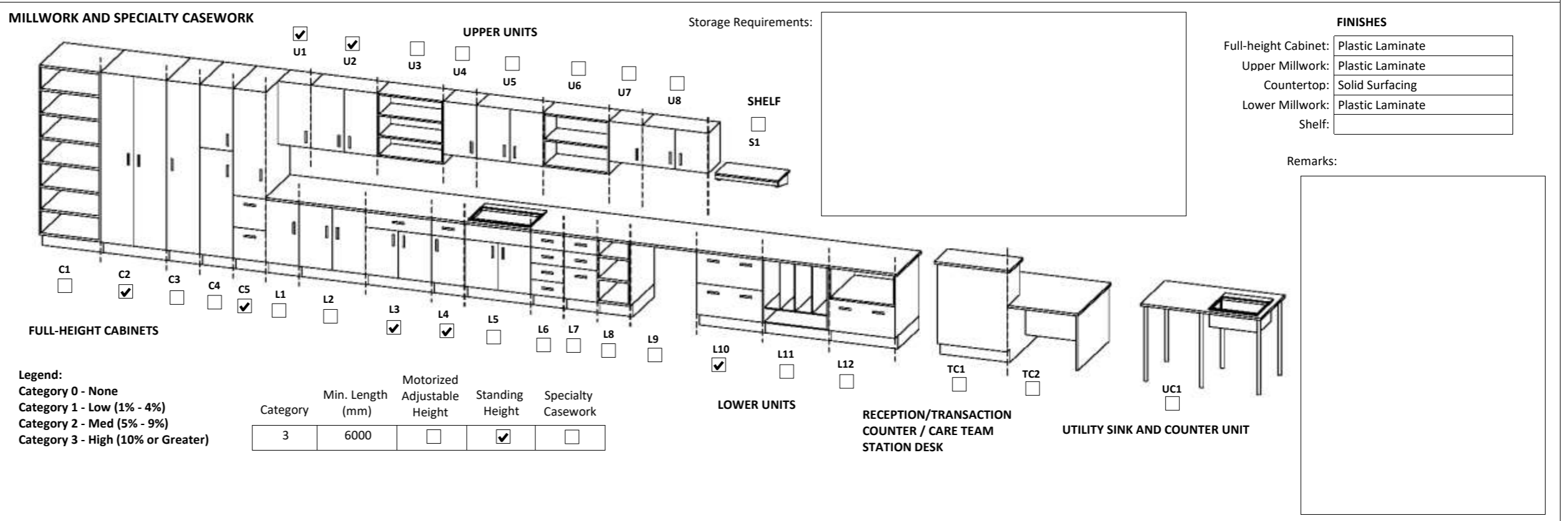

**MECHANICAL REQUIREMENTS**

**PLUMBING** (Quantity)

Hand Hygiene Sink:	1	Lavatory:		Kitchen Sink:		Seamless Kitchen Sink:		Utility / Process Sink:		Scrub Sink:		Floor Sink:	
--------------------	---	-----------	--	---------------	--	------------------------	--	-------------------------	--	-------------	--	-------------	--

Plumbing Remarks:

**Other Fixtures:**

- Shower
- Tub
- Ice Maker
- Water Closet
- Instantaneous Hot Water
- Ewewash Station
- Eyewash/Shower Station
- Emergency Shower
- Flush Rim Sink
- Floor Drain
- Water Bottle Refill Station

Other:

**MED / NON-MED GASES** (Quantity)

Oxygen:	2	Medical Air:	1	Medical Vacuum:	2	Nitrous Oxide:		CO2:		AGSS:		Nitrogen:	1	Laboratory Air:		Laboratory Vacuum:		Utility Compressed Air:	
---------	---	--------------	---	-----------------	---	----------------	--	------	--	-------	--	-----------	---	-----------------	--	--------------------	--	-------------------------	--

Gas Remarks:



**Appendix 1B Minimum Room Requirements**

Room Name:

Program Number(s):

1. F2.09	7.	13.	19.	25.	31.	37.	43.
2.	8.	14.	20.	26.	32.	38.	44.
3.	9.	15.	21.	27.	33.	39.	45.
4.	10.	16.	22.	28.	34.	40.	46.
5.	11.	17.	23.	29.	35.	41.	47.
6.	12.	18.	24.	30.	36.	42.	48.

**ARCHITECTURAL REQUIREMENTS**

<b>WALL AND CEILING</b> Wall Material: <input type="text" value="ARGB 1.2m AFF, GB above"/> Finish: <input type="text" value="PT"/> Ceiling Material: <input type="text" value="ACT"/> Finish: <input type="text" value="PF"/>	<b>WALL PROTECTION</b> Type: <input type="text" value="PVW"/> <input checked="" type="checkbox"/> Corner Guards <input type="checkbox"/> Hand Rails <input type="checkbox"/> Bed Bumper / Locator Height: <input type="text" value="1350 mm"/> <input type="checkbox"/> Crash Rails <input type="checkbox"/> Chair Rail	<b>GLAZING</b> <input type="checkbox"/> Interior Glazing	<b>FLOORING TYPES</b> Material: <input type="text" value="SDVF"/> Base: <input type="text" value="FCB"/>	<b>ROOM ACCESSORIES</b> <input checked="" type="checkbox"/> Coat Hooks <input checked="" type="checkbox"/> Ceiling Lift <input checked="" type="checkbox"/> Magnetic Whiteboard <input type="checkbox"/> Mirror <input type="checkbox"/> Infant Change Table <input type="checkbox"/> Privacy Curtain
--	---	---	---	---

- LEGEND:**
- WALL AND CEILING LEGEND:**
- AC Architectural Ceiling
  - ACT Acoustic Ceiling Tile
  - ACT-C Cleanroom
  - ARGB Abuse-Resistant Gypsum Board
  - GB Gypsum Board
  - IRGB Impact-Resistant Gypsum Board
  - KLCT Kitchen Lay-in Ceiling Tile
  - MMRGB Moisture and Mould-Resistant Gypsum Board
  - SACT Security Acoustic Ceiling Tile
- WALL FINISHES LEGEND:**
- EWC Epoxy Wall Coating
  - HPC High Performance Coating
  - PT Paint
- CEILING FINISHES LEGEND:**
- ECC Epoxy Ceiling Coating
  - HPC High Performance Coating
  - PF Prefinished
  - PT Paint
- WALL PROTECTION LEGEND:**
- ESRP Extruded Semi-Rigid PVCu Panel
  - FRL Fibre Reinforced Laminate
  - FRP Fibreglass Reinforced Plastic
  - PVW Protective Vinyl Wallcovering
  - RHIS Rigid High Impact Sheet
  - WSSP Wetwall Solid Surface Panel
  - WVV Wetroom Vinyl Wallcovering
- FLOOR FINISHES LEGEND:**
- CFS Concrete Floor Sealer
  - EFC Epoxy Floor Coating
  - PFC Polyurethane Floor Coating
  - RAF Rubber Athletic Flooring
  - RSF Rubber Sheet Flooring
  - SCF Seamless Cushioned Flooring
  - SDRF Static-Dissipative Rubber Sheet Flooring
  - SDVF Static-Dissipative Vinyl Sheet Flooring
  - VSF Vinyl Sheet Flooring
  - WSVF Wetroom Safety Vinyl Sheet Flooring
- FLOOR BASE LEGEND:**
- FCB Flash Cove Base
  - RB Rubber Base
  - SCF Seamless Cushioned Flooring

**DOORS**

Types:

Note: for Type F doors, the door panels will be approximately 465/1065 unless otherwise required by the Authority

Type	Qty	Size (mm)	Material	Finish	Side Lt.	Blinds	Protect.	Privacy Film	Function	Card Reader	Mag Lock	Auto Opener	Hold Open	Hinges	Accessory 1	Accessory 2	Accessory 3	Closer
F	1	1530 x 2135	Solid Core	FRL	<input type="checkbox"/>	<input type="checkbox"/>	2 High	<input type="checkbox"/>	Storeroom	<input checked="" type="checkbox"/>	<input type="checkbox"/>	<input type="checkbox"/>	<input checked="" type="checkbox"/>	Butt Hinge	Astragal	Flush Bolt		Concealed

**FINISHES**

Full-height Cabinet:

Upper Millwork:

Countertop:

Lower Millwork:

Shelf:

Remarks:

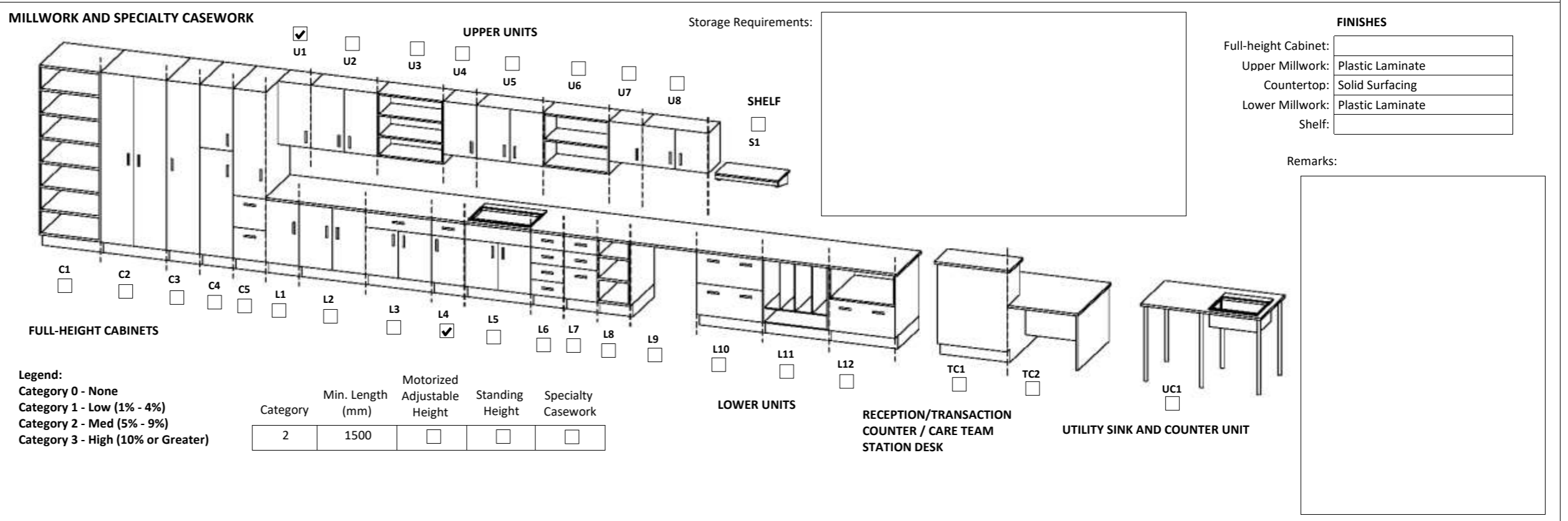

**MECHANICAL REQUIREMENTS**

<b>PLUMBING</b> (Quantity) Hand Hygiene Sink: <input type="text" value="1"/> Lavatory: <input type="text"/> Kitchen Sink: <input type="text"/> Seamless Kitchen Sink: <input type="text"/> Utility / Process Sink: <input type="text"/> Scrub Sink: <input type="text"/> Floor Sink: <input type="text"/> Plumbing Remarks: <input type="text"/>	Other Fixtures: <input type="checkbox"/> Shower <input type="checkbox"/> Eyewash Station <input type="checkbox"/> Tub <input type="checkbox"/> Eyewash/Shower Station <input type="checkbox"/> Ice Maker <input type="checkbox"/> Emergency Shower <input type="checkbox"/> Water Closet <input type="checkbox"/> Flush Rim Sink <input type="checkbox"/> Instantaneous Hot Water <input type="checkbox"/> Floor Drain <input type="checkbox"/> <input type="checkbox"/> Water Bottle Refill Station Other: <input type="text"/>	<b>MED / NON-MED GASES</b> (Quantity) Oxygen: <input type="text" value="1"/> Medical Air: <input type="text" value="1"/> Medical Vacuum: <input type="text" value="1"/> Nitrous Oxide: <input type="text"/> CO2: <input type="text"/> AGSS: <input type="text"/> Nitrogen: <input type="text"/> Laboratory Air: <input type="text"/> Laboratory Vacuum: <input type="text"/> Utility Compressed Air: <input type="text"/> Gas Remarks: <input type="text"/>
---	---	--

**Appendix 1B Minimum Room Requirements**

Room Name:

Program Number(s):

1. F6.12	7.	13.	19.	25.	31.	37.	43.
2.	8.	14.	20.	26.	32.	38.	44.
3.	9.	15.	21.	27.	33.	39.	45.
4.	10.	16.	22.	28.	34.	40.	46.
5.	11.	17.	23.	29.	35.	41.	47.
6.	12.	18.	24.	30.	36.	42.	48.

**ARCHITECTURAL REQUIREMENTS**

<b>WALL AND CEILING</b> Wall Material: <input type="text" value="ARGB 1.2m AFF, GB above"/> Finish: <input type="text" value="PT"/> Ceiling Material: <input type="text" value="ACT"/> Finish: <input type="text" value="PF"/>	<b>WALL PROTECTION</b> Type: <input type="text" value="PVW"/> <input checked="" type="checkbox"/> Corner Guards <input type="checkbox"/> Hand Rails <input type="checkbox"/> Bed Bumper / Locator Height: <input type="text" value="1350 mm"/> <input type="checkbox"/> Crash Rails <input type="checkbox"/> Chair Rail	<b>GLAZING</b> <input type="checkbox"/> Interior Glazing	<b>FLOORING TYPES</b> Material: <input type="text" value="SDVF"/> Base: <input type="text" value="FCB"/>	<b>ROOM ACCESSORIES</b> <input checked="" type="checkbox"/> Coat Hooks <input type="checkbox"/> Ceiling Lift <input checked="" type="checkbox"/> Magnetic Whiteboard <input type="checkbox"/> Mirror <input type="checkbox"/> Infant Change Table <input type="checkbox"/> Privacy Curtain
--	---	---	---	--

- LEGEND:**
- WALL AND CEILING LEGEND:**
- AC Architectural Ceiling
  - ACT Acoustic Ceiling Tile
  - ACT-C Cleanroom
  - ARGB Abuse-Resistant Gypsum Board
  - GB Gypsum Board
  - IRGB Impact-Resistant Gypsum Board
  - KLCT Kitchen Lay-in Ceiling Tile
  - MMRGB Moisture and Mould-Resistant Gypsum Board
  - SACT Security Acoustic Ceiling Tile
- WALL FINISHES LEGEND:**
- EWC Epoxy Wall Coating
  - HPC High Performance Coating
  - PT Paint
- CEILING FINISHES LEGEND:**
- ECC Epoxy Ceiling Coating
  - HPC High Performance Coating
  - PF Prefinished
  - PT Paint
- WALL PROTECTION LEGEND:**
- ESRP Extruded Semi-Rigid PVCu Panel
  - FRL Fibre Reinforced Laminate
  - FRP Fibreglass Reinforced Plastic
  - PVW Protective Vinyl Wallcovering
  - RHIS Rigid High Impact Sheet
  - WSSP Wetwall Solid Surface Panel
  - WVV Wetroom Vinyl Wallcovering
- FLOOR FINISHES LEGEND:**
- CFS Concrete Floor Sealer
  - EFC Epoxy Floor Coating
  - PFC Polyurethane Floor Coating
  - RAF Rubber Athletic Flooring
  - RSF Rubber Sheet Flooring
  - SCF Seamless Cushioned Flooring
  - SDRF Static-Dissipative Rubber Sheet Flooring
  - SDVF Static-Dissipative Vinyl Sheet Flooring
  - VSF Vinyl Sheet Flooring
  - WSVF Wetroom Safety Vinyl Sheet Flooring
- FLOOR BASE LEGEND:**
- FCB Flash Cove Base
  - RB Rubber Base
  - SCF Seamless Cushioned Flooring

**DOORS**

Types:

Type	Qty	Size (mm)	Material	Finish	Side Lt.	Blinds	Protect.	Privacy Film	Function	Card Reader	Mag Lock	Auto Opener	Hold Open	Hinges	Accessory 1	Accessory 2	Accessory 3	Closer
A	1	1220 x 2135	Shielded	Prefinished	<input type="checkbox"/>	<input type="checkbox"/>	2 High	<input type="checkbox"/>	Storeroom	<input checked="" type="checkbox"/>	<input type="checkbox"/>	<input type="checkbox"/>	<input checked="" type="checkbox"/>	Butt Hinge				Concealed

Door Remarks: RF shielded MRI door, refer to Section 6.13 Special Construction (Division 13), Section 13 49 23 – Radio Frequency Shielding Systems

- Security Grille
- Anti-barricade strategy

**MILLWORK AND SPECIALTY CASEWORK**

Storage Requirements:

**UPPER UNITS** (U1-U8)

**LOWER UNITS** (L1-L12)

**RECEPTION/TRANSACTION COUNTER / CARE TEAM STATION DESK** (TC1, TC2)

**UTILITY SINK AND COUNTER UNIT** (UC1)

**FINISHES**

Full-height Cabinet:	Plastic Laminate
Upper Millwork:	Plastic Laminate
Countertop:	Solid Surfacing
Lower Millwork:	Plastic Laminate
Shelf:	

Remarks:

**MECHANICAL REQUIREMENTS**

<b>PLUMBING</b> (Quantity) Hand Hygiene Sink: <input type="text" value="1"/> Lavatory: <input type="text"/> Kitchen Sink: <input type="text"/> Seamless Kitchen Sink: <input type="text"/> Utility / Process Sink: <input type="text"/> Scrub Sink: <input type="text"/> Floor Sink: <input type="text"/> Plumbing Remarks: <input type="text"/>	Other Fixtures: <input type="checkbox"/> Shower <input type="checkbox"/> Eyewash Station <input type="checkbox"/> Tub <input type="checkbox"/> Eyewash/Shower Station <input type="checkbox"/> Ice Maker <input type="checkbox"/> Emergency Shower <input type="checkbox"/> Water Closet <input type="checkbox"/> Flush Rim Sink <input type="checkbox"/> Instantaneous Hot Water <input type="checkbox"/> Floor Drain <input type="checkbox"/> <input type="checkbox"/> Water Bottle Refill Station Other: <input type="text"/>	<b>MED / NON-MED GASES</b> (Quantity) Oxygen: <input type="text" value="2"/> Medical Air: <input type="text" value="1"/> Medical Vacuum: <input type="text" value="2"/> Nitrous Oxide: <input type="text"/> CO2: <input type="text"/> AGSS: <input type="text"/> Nitrogen: <input type="text"/> Laboratory Air: <input type="text"/> Laboratory Vacuum: <input type="text"/> Utility Compressed Air: <input type="text"/> Gas Remarks: <input type="text"/>
---	---	--

**Appendix 1B Minimum Room Requirements**

Room Name:

Program Number(s):

1. F3.12	7.	13.	19.	25.	31.	37.	43.
2.	8.	14.	20.	26.	32.	38.	44.
3.	9.	15.	21.	27.	33.	39.	45.
4.	10.	16.	22.	28.	34.	40.	46.
5.	11.	17.	23.	29.	35.	41.	47.
6.	12.	18.	24.	30.	36.	42.	48.

**ARCHITECTURAL REQUIREMENTS**

<b>WALL AND CEILING</b> Wall Material: <input type="text" value="ARGB 1.2m AFF, GB above"/> Finish: <input type="text" value="PT"/> Ceiling Material: <input type="text" value="ACT"/> Finish: <input type="text" value="PF"/>	<b>WALL PROTECTION</b> Type: <input type="text" value="FRP"/> <input checked="" type="checkbox"/> Corner Guards <input type="checkbox"/> Hand Rails <input type="checkbox"/> Bed Bumper / Locator Height: <input type="text" value="2185 mm"/> <input type="checkbox"/> Crash Rails <input type="checkbox"/> Chair Rail	<b>GLAZING</b> <input type="checkbox"/> Interior Glazing	<b>FLOORING TYPES</b> Material: <input type="text" value="WSVF"/> Base: <input type="text" value="FCB"/>	<b>ROOM ACCESSORIES</b> <input type="checkbox"/> Coat Hooks <input type="checkbox"/> Ceiling Lift <input checked="" type="checkbox"/> Magnetic Whiteboard <input type="checkbox"/> Mirror <input type="checkbox"/> Infant Change Table <input type="checkbox"/> Privacy Curtain
--	---	---	---	---

- LEGEND:**
- WALL AND CEILING LEGEND:**
- AC Architectural Ceiling
  - ACT Acoustic Ceiling Tile
  - ACT-C Cleanroom
  - ARGB Abuse-Resistant Gypsum Board
  - GB Gypsum Board
  - IRGB Impact-Resistant Gypsum Board
  - KLCT Kitchen Lay-in Ceiling Tile
  - MMRGB Moisture and Mould-Resistant Gypsum Board
  - SACT Security Acoustic Ceiling Tile
- WALL FINISHES LEGEND:**
- EWC Epoxy Wall Coating
  - HPC High Performance Coating
  - PT Paint
- CEILING FINISHES LEGEND:**
- ECC Epoxy Ceiling Coating
  - HPC High Performance Coating
  - PF Prefinished
  - PT Paint
- WALL PROTECTION LEGEND:**
- ESRP Extruded Semi-Rigid PVCu Panel
  - FRL Fibre Reinforced Laminate
  - FRP Fibreglass Reinforced Plastic
  - PVV Protective Vinyl Wallcovering
  - RHIS Rigid High Impact Sheet
  - WSSP Wetwall Solid Surface Panel
  - WVV Wetroom Vinyl Wallcovering
- FLOOR FINISHES LEGEND:**
- CFS Concrete Floor Sealer
  - EFC Epoxy Floor Coating
  - PFC Polyurethane Floor Coating
  - RAF Rubber Athletic Flooring
  - RSF Rubber Sheet Flooring
  - SCF Seamless Cushioned Flooring
  - SDRF Static-Dissipative Rubber Sheet Flooring
  - SDVF Static-Dissipative Vinyl Sheet Flooring
  - VSF Vinyl Sheet Flooring
  - WSVF Wetroom Safety Vinyl Sheet Flooring
- FLOOR BASE LEGEND:**
- FCB Flash Cove Base
  - RB Rubber Base
  - SCF Seamless Cushioned Flooring

**DOORS**

Types:

Type	Qty	Size (mm)	Material	Finish	Side Lt.	Blinds	Protect.	Privacy Film	Function	Card Reader	Mag Lock	Auto Opener	Hold Open	Hinges	Accessory 1	Accessory 2	Accessory 3	Closer
C	1	1220 x 2135	Solid Core	FRL	<input type="checkbox"/>	<input type="checkbox"/>	2 High	<input checked="" type="checkbox"/>	Storeroom	<input checked="" type="checkbox"/>	<input type="checkbox"/>	<input checked="" type="checkbox"/>	<input type="checkbox"/>	Butt Hinge	Elec. Strike			Surface

Door Remarks:  Security Grille  Anti-barricade strategy

**MILLWORK AND SPECIALTY CASEWORK**

Storage Requirements:

**UPPER UNITS** (U1-U8)

**LOWER UNITS** (L1-L12)

**RECEPTION/TRANSACTION COUNTER / CARE TEAM STATION DESK** (TC1, TC2)

**UTILITY SINK AND COUNTER UNIT** (UC1)

**SHELF** (S1)

**FULL-HEIGHT CABINETS** (C1-C5)

Category	Min. Length (mm)	Motorized Adjustable Height	Standing Height	Specialty Casework
3	2400	<input type="checkbox"/>	<input type="checkbox"/>	<input type="checkbox"/>

**FINISHES**

Full-height Cabinet:

Upper Millwork:

Countertop:

Lower Millwork:

Shelf:

Remarks:

**MECHANICAL REQUIREMENTS**

<b>PLUMBING</b> (Quantity) Hand Hygiene Sink: <input type="text" value="1"/> Lavatory: <input type="text"/> Kitchen Sink: <input type="text"/> Seamless Kitchen Sink: <input type="text"/> Utility / Process Sink: <input type="text" value="1"/> Scrub Sink: <input type="text"/> Floor Sink: <input type="text"/> Plumbing Remarks: <input type="text" value="Provide double utility sink."/>	Other Fixtures: <input type="checkbox"/> Shower <input type="checkbox"/> Eyewash Station <input type="checkbox"/> Tub <input type="checkbox"/> Eyewash/Shower Station <input type="checkbox"/> Ice Maker <input type="checkbox"/> Emergency Shower <input type="checkbox"/> Water Closet <input type="checkbox"/> Flush Rim Sink <input type="checkbox"/> Instantaneous Hot Water <input type="checkbox"/> Floor Drain <input type="checkbox"/> <input type="checkbox"/> Water Bottle Refill Station Other <input type="text"/>	<b>MED / NON-MED GASES</b> (Quantity) Oxygen: <input type="text"/> Medical Air: <input type="text"/> Medical Vacuum: <input type="text"/> Nitrous Oxide: <input type="text"/> CO2: <input type="text"/> AGSS: <input type="text"/> Nitrogen: <input type="text"/> Laboratory Air: <input type="text"/> Laboratory Vacuum: <input type="text"/> Utility Compressed Air: <input type="text"/> Gas Remarks: <input type="text"/>
--	--	---



**Appendix 1B Minimum Room Requirements**

Room Name:

Program Number(s):

1. F4.10	7.	13.	19.	25.	31.	37.	43.
2.	8.	14.	20.	26.	32.	38.	44.
3.	9.	15.	21.	27.	33.	39.	45.
4.	10.	16.	22.	28.	34.	40.	46.
5.	11.	17.	23.	29.	35.	41.	47.
6.	12.	18.	24.	30.	36.	42.	48.

**ARCHITECTURAL REQUIREMENTS**

<b>WALL AND CEILING</b> Wall Material: <input type="text" value="ARGB 1.2m AFF, GB above"/> Finish: <input type="text" value="PT"/> Ceiling Material: <input type="text" value="GB"/> Finish: <input type="text" value="ECC"/>		<b>WALL PROTECTION</b> Type: <input type="text" value="ESRP"/> <input checked="" type="checkbox"/> Corner Guards <input type="checkbox"/> Hand Rails <input type="checkbox"/> Bed Bumper / Locator Height: <input type="text" value="2185 mm"/> <input type="checkbox"/> Crash Rails <input type="checkbox"/> Chair Rail		<b>GLAZING</b> <input checked="" type="checkbox"/> Interior Glazing		<b>FLOORING TYPES</b> Material: <input type="text" value="SDRF"/> Base: <input type="text" value="FCB"/>		<b>ROOM ACCESSORIES</b> <input checked="" type="checkbox"/> Coat Hooks <input checked="" type="checkbox"/> Ceiling Lift <input checked="" type="checkbox"/> Magnetic Whiteboard <input type="checkbox"/> Mirror <input type="checkbox"/> Infant Change Table <input checked="" type="checkbox"/> Privacy Curtain	
--	--	--	--	--	--	---	--	--	--

- LEGEND:**
- WALL AND CEILING LEGEND:**
- AC Architectural Ceiling
  - ACT Acoustic Ceiling Tile
  - ACT-C Cleanroom
  - ARGB Abuse-Resistant Gypsum Board
  - GB Gypsum Board
  - IRGB Impact-Resistant Gypsum Board
  - KLCT Kitchen Lay-in Ceiling Tile
  - MMRGB Moisture and Mould-Resistant Gypsum Board
  - SACT Security Acoustic Ceiling Tile
- WALL FINISHES LEGEND:**
- EWC Epoxy Wall Coating
  - HPC High Performance Coating
  - PT Paint
- CEILING FINISHES LEGEND:**
- ECC Epoxy Ceiling Coating
  - HPC High Performance Coating
  - PF Prefinished
  - PT Paint
- WALL PROTECTION LEGEND:**
- ESRP Extruded Semi-Rigid PVCu Panel
  - FRL Fibre Reinforced Laminate
  - FRP Fibreglass Reinforced Plastic
  - PVV Protective Vinyl Wallcovering
  - RHIS Rigid High Impact Sheet
  - WSSP Wetwall Solid Surface Panel
  - WVV Wetroom Vinyl Wallcovering
- FLOOR FINISHES LEGEND:**
- CFS Concrete Floor Sealer
  - EFC Epoxy Floor Coating
  - PFC Polyurethane Floor Coating
  - RAF Rubber Athletic Flooring
  - RSF Rubber Sheet Flooring
  - SCF Seamless Cushioned Flooring
  - SDRF Static-Dissipative Rubber Sheet Flooring
  - SDVF Static-Dissipative Vinyl Sheet Flooring
  - VSF Vinyl Sheet Flooring
  - WSVF Wetroom Safety Vinyl Sheet Flooring
- FLOOR BASE LEGEND:**
- FCB Flash Cove Base
  - RB Rubber Base
  - SCF Seamless Cushioned Flooring

**DOORS**

Types:

Note: for Type F doors, the door panels will be approximately 465/1065 unless otherwise required by the Authority

Type	Qty	Size (mm)	Material	Finish	Side Lt.	Blinds	Protect.	Privacy Film	Function	Card Reader	Mag Lock	Auto Opener	Hold Open	Hinges	Accessory 1	Accessory 2	Accessory 3	Closer
F	1	1530 x 2135	Solid Core	FRL	<input type="checkbox"/>	<input type="checkbox"/>	2 High	<input type="checkbox"/>	Storeroom	<input checked="" type="checkbox"/>	<input type="checkbox"/>	<input type="checkbox"/>	<input checked="" type="checkbox"/>	Butt Hinge	Astragal	Flush Bolt		Concealed

**FINISHES**

Full-height Cabinet:

Upper Millwork:

Countertop:

Lower Millwork:

Shelf:

Remarks:

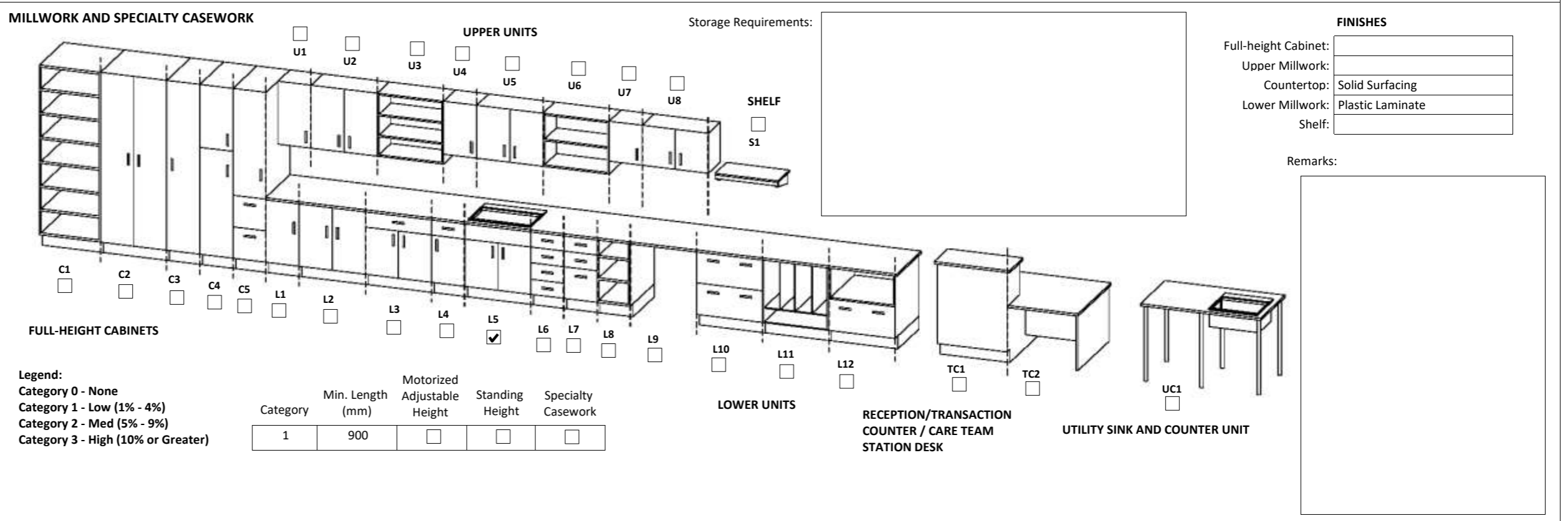

**MECHANICAL REQUIREMENTS**

**PLUMBING**

Hand Hygiene Sink: <input type="text" value="1"/>	Lavatory: <input type="text"/>	Kitchen Sink: <input type="text"/>	Seamless Kitchen Sink: <input type="text"/>	Utility / Process Sink: <input type="text" value="1"/>	Scrub Sink: <input type="text"/>	Floor Sink: <input type="text"/>
---	--------------------------------	------------------------------------	---	--	----------------------------------	----------------------------------

Plumbing Remarks:

**Other Fixtures:**

- Shower
- Tub
- Ice Maker
- Water Closet
- Instantaneous Hot Water
- Eyewash Station
- Eyewash/Shower Station
- Emergency Shower
- Flush Rim Sink
- Floor Drain
- Water Bottle Refill Station

Other:

**MED / NON-MED GASES**

Oxygen: <input type="text" value="2"/>	Medical Air: <input type="text" value="1"/>	Medical Vacuum: <input type="text" value="2"/>	Nitrous Oxide: <input type="text"/>	CO2: <input type="text"/>	AGSS: <input type="text"/>	Nitrogen: <input type="text"/>	Laboratory Air: <input type="text"/>	Laboratory Vacuum: <input type="text"/>	Utility Compressed Air: <input type="text"/>
--	---	--	-------------------------------------	---------------------------	----------------------------	--------------------------------	--------------------------------------	---	--

Gas Remarks:

**Appendix 1B Minimum Room Requirements**

Room Name:

Program Number(s):

1. F4.23	7.	13.	19.	25.	31.	37.	43.
2.	8.	14.	20.	26.	32.	38.	44.
3.	9.	15.	21.	27.	33.	39.	45.
4.	10.	16.	22.	28.	34.	40.	46.
5.	11.	17.	23.	29.	35.	41.	47.
6.	12.	18.	24.	30.	36.	42.	48.

**ARCHITECTURAL REQUIREMENTS**

<b>WALL AND CEILING</b> Wall Material: <input type="text" value="ARGB 1.2m AFF, GB above"/> Finish: <input type="text" value="PT"/> Ceiling Material: <input type="text" value="GB"/> Finish: <input type="text" value="ECC"/>	<b>WALL PROTECTION</b> Type: <input type="text" value="ESRP"/> <input checked="" type="checkbox"/> Corner Guards <input type="checkbox"/> Hand Rails <input type="checkbox"/> Bed Bumper / Locator Height: <input type="text" value="2185 mm"/> <input type="checkbox"/> Crash Rails <input type="checkbox"/> Chair Rail	<b>GLAZING</b> <input checked="" type="checkbox"/> Interior Glazing	<b>FLOORING TYPES</b> Material: <input type="text" value="SDRF"/> Base: <input type="text" value="FCB"/>	<b>ROOM ACCESSORIES</b> <input checked="" type="checkbox"/> Coat Hooks <input checked="" type="checkbox"/> Ceiling Lift <input checked="" type="checkbox"/> Magnetic Whiteboard <input type="checkbox"/> Mirror <input type="checkbox"/> Infant Change Table <input checked="" type="checkbox"/> Privacy Curtain
--	--	--	---	--

- LEGEND:**
- WALL AND CEILING LEGEND:**
- AC Architectural Ceiling
  - ACT Acoustic Ceiling Tile
  - ACT-C Cleanroom
  - ARGB Abuse-Resistant Gypsum Board
  - GB Gypsum Board
  - IRGB Impact-Resistant Gypsum Board
  - KLCT Kitchen Lay-in Ceiling Tile
  - MMRGB Moisture and Mould-Resistant Gypsum Board
  - SACT Security Acoustic Ceiling Tile
- WALL FINISHES LEGEND:**
- EWC Epoxy Wall Coating
  - HPC High Performance Coating
  - PT Paint
- CEILING FINISHES LEGEND:**
- ECC Epoxy Ceiling Coating
  - HPC High Performance Coating
  - PF Prefinished
  - PT Paint
- WALL PROTECTION LEGEND:**
- ESRP Extruded Semi-Rigid PVCu Panel
  - FRL Fibre Reinforced Laminate
  - FRP Fibreglass Reinforced Plastic
  - PVV Protective Vinyl Wallcovering
  - RHIS Rigid High Impact Sheet
  - WSSP Wetwall Solid Surface Panel
  - WVV Wetroom Vinyl Wallcovering
- FLOOR FINISHES LEGEND:**
- CFS Concrete Floor Sealer
  - EFC Epoxy Floor Coating
  - PFC Polyurethane Floor Coating
  - RAF Rubber Athletic Flooring
  - RSF Rubber Sheet Flooring
  - SCF Seamless Cushioned Flooring
  - SDRF Static-Dissipative Rubber Sheet Flooring
  - SDVF Static-Dissipative Vinyl Sheet Flooring
  - VSF Vinyl Sheet Flooring
  - WSVF Wetroom Safety Vinyl Sheet Flooring
- FLOOR BASE LEGEND:**
- FCB Flash Cove Base
  - RB Rubber Base
  - SCF Seamless Cushioned Flooring

**DOORS**

Types:

Note: for Type F doors, the door panels will be approximately 465/1065 unless otherwise required by the Authority

Door Remarks:  Security Grille  Anti-barricade strategy

Type	Qty	Size (mm)	Material	Finish	Side Lt.	Blinds	Protect.	Privacy Film	Function	Card Reader	Mag Lock	Auto Opener	Hold Open	Hinges	Accessory 1	Accessory 2	Accessory 3	Closer
F	1	1530 x 2135	Solid Core	FRL	<input type="checkbox"/>	<input type="checkbox"/>	2 High	<input type="checkbox"/>	Storeroom	<input checked="" type="checkbox"/>	<input type="checkbox"/>	<input type="checkbox"/>	<input checked="" type="checkbox"/>	Butt Hinge	Astragal	Flush Bolt		Concealed

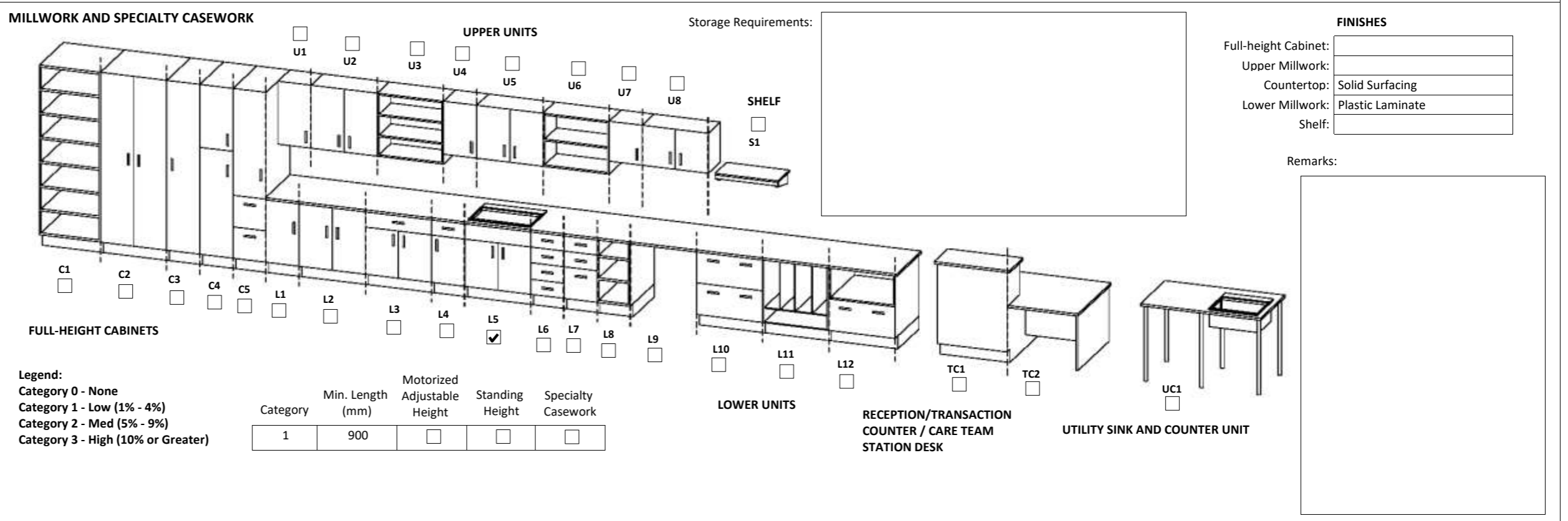

**MECHANICAL REQUIREMENTS**

<b>PLUMBING</b> (Quantity) Hand Hygiene Sink: <input type="text" value="1"/> Lavatory: <input type="text"/> Kitchen Sink: <input type="text"/> Seamless Kitchen Sink: <input type="text"/> Utility / Process Sink: <input type="text" value="1"/> Scrub Sink: <input type="text"/> Floor Sink: <input type="text"/> Plumbing Remarks: <input type="text" value="Utility sink to have a trap for the barium"/>	Other Fixtures: <input type="checkbox"/> Shower <input type="checkbox"/> Eyewash Station <input type="checkbox"/> Tub <input type="checkbox"/> Eyewash/Shower Station <input type="checkbox"/> Ice Maker <input type="checkbox"/> Emergency Shower <input type="checkbox"/> Water Closet <input type="checkbox"/> Flush Rim Sink <input type="checkbox"/> Instantaneous Hot Water <input type="checkbox"/> Floor Drain <input type="checkbox"/> <input type="checkbox"/> Water Bottle Refill Station Other: <input type="text"/>	<b>MED / NON-MED GASES</b> (Quantity) Oxygen: <input type="text" value="2"/> Medical Air: <input type="text" value="1"/> Medical Vacuum: <input type="text" value="2"/> Nitrous Oxide: <input type="text"/> CO2: <input type="text"/> AGSS: <input type="text"/> Nitrogen: <input type="text"/> Laboratory Air: <input type="text"/> Laboratory Vacuum: <input type="text"/> Utility Compressed Air: <input type="text"/> Gas Remarks: <input type="text"/>
--	---	---

**Appendix 1B Minimum Room Requirements**

Room Name:

Program Number(s):

1. F3.11	7.	13.	19.	25.	31.	37.	43.
2.	8.	14.	20.	26.	32.	38.	44.
3.	9.	15.	21.	27.	33.	39.	45.
4.	10.	16.	22.	28.	34.	40.	46.
5.	11.	17.	23.	29.	35.	41.	47.
6.	12.	18.	24.	30.	36.	42.	48.

**ARCHITECTURAL REQUIREMENTS**

<b>WALL AND CEILING</b> Wall Material: <input type="text" value="ARGB 1.2m AFF, GB above"/> Finish: <input type="text" value="PT"/> Ceiling Material: <input type="text" value="ACT"/> Finish: <input type="text" value="PF"/>	<b>WALL PROTECTION</b> Type: <input type="text"/> Height: <input type="text"/> <input checked="" type="checkbox"/> Corner Guards <input type="checkbox"/> Hand Rails <input type="checkbox"/> Bed Bumper / Locator <input type="checkbox"/> Crash Rails <input checked="" type="checkbox"/> Chair Rail	<b>GLAZING</b> <input type="checkbox"/> Interior Glazing	<b>FLOORING TYPES</b> Material: <input type="text" value="VSF"/> Base: <input type="text" value="FCB"/>	<b>ROOM ACCESSORIES</b> <input checked="" type="checkbox"/> Coat Hooks <input type="checkbox"/> Ceiling Lift <input checked="" type="checkbox"/> Magnetic Whiteboard <input type="checkbox"/> Mirror <input type="checkbox"/> Infant Change Table <input type="checkbox"/> Privacy Curtain
--	---	---	--	--

- LEGEND:**
- WALL AND CEILING LEGEND:**
- AC Architectural Ceiling
  - ACT Acoustic Ceiling Tile
  - ACT-C Cleanroom
  - ARGB Abuse-Resistant Gypsum Board
  - GB Gypsum Board
  - IRGB Impact-Resistant Gypsum Board
  - KLCT Kitchen Lay-in Ceiling Tile
  - MMRGB Moisture and Mould-Resistant Gypsum Board
  - SACT Security Acoustic Ceiling Tile
- WALL FINISHES LEGEND:**
- EWC Epoxy Wall Coating
  - HPC High Performance Coating
  - PT Paint
- CEILING FINISHES LEGEND:**
- ECC Epoxy Ceiling Coating
  - HPC High Performance Coating
  - PF Prefinished
  - PT Paint
- WALL PROTECTION LEGEND:**
- ESRP Extruded Semi-Rigid PVCu Panel
  - FRL Fibre Reinforced Laminate
  - FRP Fibreglass Reinforced Plastic
  - PVV Protective Vinyl Wallcovering
  - RHIS Rigid High Impact Sheet
  - WSSP Wetwall Solid Surface Panel
  - WVV Wetroom Vinyl Wallcovering
- FLOOR FINISHES LEGEND:**
- CFS Concrete Floor Sealer
  - EFC Epoxy Floor Coating
  - PFC Polyurethane Floor Coating
  - RAF Rubber Athletic Flooring
  - RSF Rubber Sheet Flooring
  - SCF Seamless Cushioned Flooring
  - SDRF Static-Dissipative Rubber Sheet Flooring
  - SDVF Static-Dissipative Vinyl Sheet Flooring
  - VSF Vinyl Sheet Flooring
  - WSVF Wetroom Safety Vinyl Sheet Flooring
- FLOOR BASE LEGEND:**
- FCB Flash Cove Base
  - RB Rubber Base
  - SCF Seamless Cushioned Flooring

**DOORS**

Types:

Type	Qty	Size (mm)	Material	Finish	Side Lt.	Blinds	Protect.	Privacy Film	Function	Card Reader	Mag Lock	Auto Opener	Hold Open	Hinges	Accessory 1	Accessory 2	Accessory 3	Closer
C	1	915 x 2135	Solid Core	FRL	<input type="checkbox"/>	<input checked="" type="checkbox"/>	1 Low	<input type="checkbox"/>	Classroom	<input type="checkbox"/>	<input type="checkbox"/>	<input type="checkbox"/>	<input type="checkbox"/>	Butt Hinge				

Door Remarks:

Security Grille  
 Anti-barricade strategy

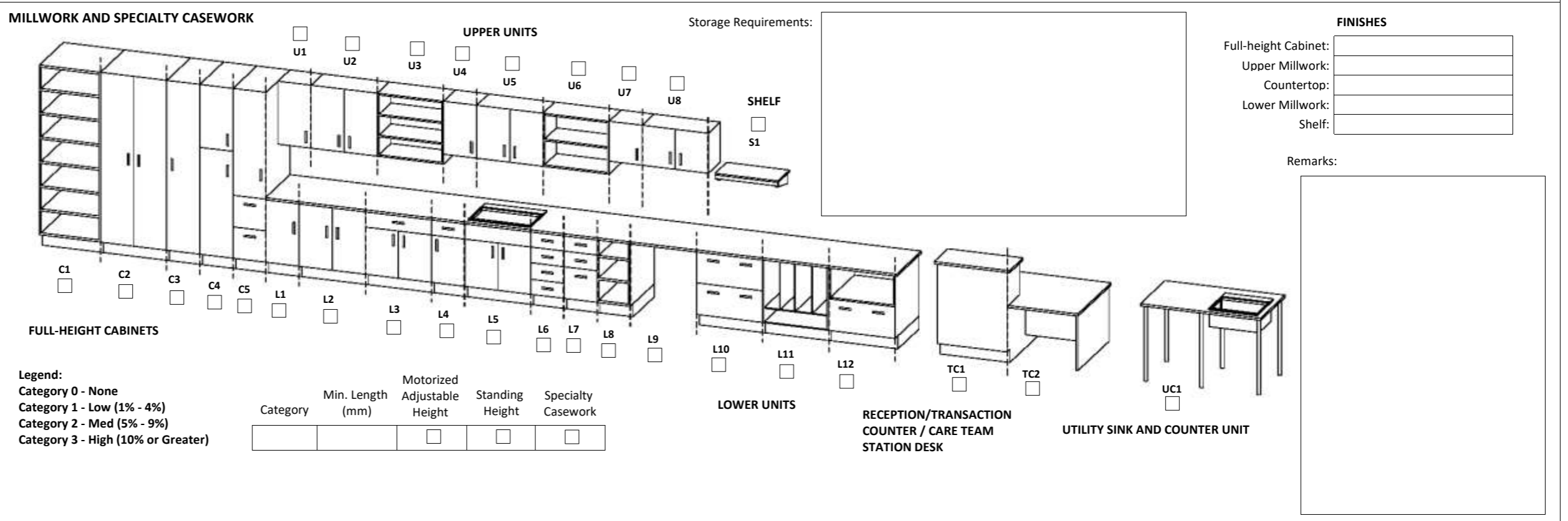

**MECHANICAL REQUIREMENTS**

<b>PLUMBING</b> (Quantity) Hand Hygiene Sink: <input type="text"/> Lavatory: <input type="text"/> Kitchen Sink: <input type="text"/> Seamless Kitchen Sink: <input type="text"/> Utility / Process Sink: <input type="text"/> Scrub Sink: <input type="text"/> Floor Sink: <input type="text"/> Plumbing Remarks: <input type="text"/>	Other Fixtures: <input type="checkbox"/> Shower <input type="checkbox"/> Tub <input type="checkbox"/> Ice Maker <input type="checkbox"/> Water Closet <input type="checkbox"/> Instantaneous Hot Water <input type="checkbox"/> Eyewash Station <input type="checkbox"/> Eyewash/Shower Station <input type="checkbox"/> Emergency Shower <input type="checkbox"/> Flush Rim Sink <input type="checkbox"/> Floor Drain <input type="checkbox"/> Water Bottle Refill Station Other: <input type="text"/>	<b>MED / NON-MED GASES</b> (Quantity) Oxygen: <input type="text"/> Medical Air: <input type="text"/> Medical Vacuum: <input type="text"/> Nitrous Oxide: <input type="text"/> CO2: <input type="text"/> AGSS: <input type="text"/> Nitrogen: <input type="text"/> Laboratory Air: <input type="text"/> Laboratory Vacuum: <input type="text"/> Utility Compressed Air: <input type="text"/> Gas Remarks: <input type="text"/>
--	--	---



**Appendix 1B Minimum Room Requirements**

Room Name:

Program Number(s):

1. F2.15	7.	13.	19.	25.	31.	37.	43.
2. F3.10	8.	14.	20.	26.	32.	38.	44.
3. F4.18	9.	15.	21.	27.	33.	39.	45.
4. F5.15	10.	16.	22.	28.	34.	40.	46.
5. F6.07	11.	17.	23.	29.	35.	41.	47.
6.	12.	18.	24.	30.	36.	42.	48.

**ARCHITECTURAL REQUIREMENTS**

<b>WALL AND CEILING</b> Wall Material: <input type="text" value="ARGB 1.2m AFF, GB above"/> Finish: <input type="text" value="PT"/> Ceiling Material: <input type="text" value="ACT"/> Finish: <input type="text" value="PF"/>		<b>WALL PROTECTION</b> Type: <input type="text"/> Height: <input type="text"/> <input checked="" type="checkbox"/> Corner Guards <input type="checkbox"/> Hand Rails <input type="checkbox"/> Bed Bumper / Locator <input type="checkbox"/> Crash Rails <input checked="" type="checkbox"/> Chair Rail		<b>GLAZING</b> <input type="checkbox"/> Interior Glazing		<b>FLOORING TYPES</b> Material: <input type="text" value="VSF"/> Base: <input type="text" value="FCB"/>		<b>ROOM ACCESSORIES</b> <input checked="" type="checkbox"/> Coat Hooks <input type="checkbox"/> Ceiling Lift <input checked="" type="checkbox"/> Magnetic Whiteboard <input type="checkbox"/> Mirror <input type="checkbox"/> Infant Change Table <input type="checkbox"/> Privacy Curtain	
--	--	---	--	---	--	--	--	--	--

- LEGEND:**
- WALL AND CEILING LEGEND:**
- AC Architectural Ceiling
  - ACT Acoustic Ceiling Tile
  - ACT-C Cleanroom
  - ARGB Abuse-Resistant Gypsum Board
  - GB Gypsum Board
  - IRGB Impact-Resistant Gypsum Board
  - KLCT Kitchen Lay-in Ceiling Tile
  - MMRGB Moisture and Mould-Resistant Gypsum Board
  - SACT Security Acoustic Ceiling Tile
- WALL FINISHES LEGEND:**
- EWC Epoxy Wall Coating
  - HPC High Performance Coating
  - PT Paint
- CEILING FINISHES LEGEND:**
- ECC Epoxy Ceiling Coating
  - HPC High Performance Coating
  - PF Prefinished
  - PT Paint
- WALL PROTECTION LEGEND:**
- ESRP Extruded Semi-Rigid PVCu Panel
  - FRL Fibre Reinforced Laminate
  - FRP Fibreglass Reinforced Plastic
  - PVV Protective Vinyl Wallcovering
  - RHIS Rigid High Impact Sheet
  - WSSP Wetwall Solid Surface Panel
  - WVV Wetroom Vinyl Wallcovering
- FLOOR FINISHES LEGEND:**
- CFS Concrete Floor Sealer
  - EFC Epoxy Floor Coating
  - PFC Polyurethane Floor Coating
  - RAF Rubber Athletic Flooring
  - RSF Rubber Sheet Flooring
  - SCF Seamless Cushioned Flooring
  - SDRF Static-Dissipative Rubber Sheet Flooring
  - SDVF Static-Dissipative Vinyl Sheet Flooring
  - VSF Vinyl Sheet Flooring
  - WSVF Wetroom Safety Vinyl Sheet Flooring
- FLOOR BASE LEGEND:**
- FCB Flash Cove Base
  - RB Rubber Base
  - SCF Seamless Cushioned Flooring

**DOORS**

Types:

Type	Qty	Size (mm)	Material	Finish	Side Lt.	Blinds	Protect.	Privacy Film	Function	Card Reader	Mag Lock	Auto Opener	Hold Open	Hinges	Accessory 1	Accessory 2	Accessory 3	Closer
C	1	915 x 2135	Solid Core	FRL	<input type="checkbox"/>	<input checked="" type="checkbox"/>	1 Low	<input type="checkbox"/>	Classroom	<input type="checkbox"/>	<input type="checkbox"/>	<input type="checkbox"/>	<input type="checkbox"/>	Butt Hinge				

Door Remarks:

Security Grille  
 Anti-barricade strategy



**MECHANICAL REQUIREMENTS**

<b>PLUMBING</b> (Quantity) Hand Hygiene Sink: <input type="text"/> Lavatory: <input type="text"/> Kitchen Sink: <input type="text"/> Seamless Kitchen Sink: <input type="text"/> Utility / Process Sink: <input type="text"/> Scrub Sink: <input type="text"/> Floor Sink: <input type="text"/>							Other Fixtures: <input type="checkbox"/> Shower <input type="checkbox"/> Eyewash Station <input type="checkbox"/> Tub <input type="checkbox"/> Eyewash/Shower Station <input type="checkbox"/> Ice Maker <input type="checkbox"/> Emergency Shower <input type="checkbox"/> Water Closet <input type="checkbox"/> Flush Rim Sink <input type="checkbox"/> Instantaneous Hot Water <input type="checkbox"/> Floor Drain <input type="checkbox"/> Water Bottle Refill Station Other: <input type="text"/>				<b>MED / NON-MED GASES</b> (Quantity) Oxygen: <input type="text"/> Medical Air: <input type="text"/> Medical Vacuum: <input type="text"/> Nitrous Oxide: <input type="text"/> CO2: <input type="text"/> AGSS: <input type="text"/> Nitrogen: <input type="text"/> Laboratory Air: <input type="text"/> Laboratory Vacuum: <input type="text"/> Utility Compressed Air: <input type="text"/>					
Plumbing Remarks: <input type="text"/>											Gas Remarks: <input type="text"/>					

**Appendix 1B Minimum Room Requirements**

Room Name:

Program Number(s):

1. F2.10	7.	13.	19.	25.	31.	37.	43.
2.	8.	14.	20.	26.	32.	38.	44.
3.	9.	15.	21.	27.	33.	39.	45.
4.	10.	16.	22.	28.	34.	40.	46.
5.	11.	17.	23.	29.	35.	41.	47.
6.	12.	18.	24.	30.	36.	42.	48.

**ARCHITECTURAL REQUIREMENTS**

<b>WALL AND CEILING</b> Wall Material: <input type="text" value="ARGB 1.2m AFF, GB above"/> Finish: <input type="text" value="PT"/> Ceiling Material: <input type="text" value="ACT"/> Finish: <input type="text" value="PF"/>	<b>WALL PROTECTION</b> Type: <input type="text" value="FRP"/> <input checked="" type="checkbox"/> Corner Guards <input type="checkbox"/> Hand Rails <input type="checkbox"/> Bed Bumper / Locator Height: <input type="text" value="1600 mm"/> <input type="checkbox"/> Crash Rails <input type="checkbox"/> Chair Rail	<b>GLAZING</b> <input type="checkbox"/> Interior Glazing	<b>FLOORING TYPES</b> Material: <input type="text" value="VSF"/> Base: <input type="text" value="FCB"/>	<b>ROOM ACCESSORIES</b> <input checked="" type="checkbox"/> Coat Hooks <input checked="" type="checkbox"/> Ceiling Lift <input checked="" type="checkbox"/> Magnetic Whiteboard <input type="checkbox"/> Mirror <input type="checkbox"/> Infant Change Table <input checked="" type="checkbox"/> Privacy Curtain
--	---	---	--	--

- LEGEND:**
- WALL AND CEILING LEGEND:**
- AC Architectural Ceiling
  - ACT Acoustic Ceiling Tile
  - ACT-C Cleanroom
  - ARGB Abuse-Resistant Gypsum Board
  - GB Gypsum Board
  - IRGB Impact-Resistant Gypsum Board
  - KLCT Kitchen Lay-in Ceiling Tile
  - MMRGB Moisture and Mould-Resistant Gypsum Board
  - SACT Security Acoustic Ceiling Tile
- WALL FINISHES LEGEND:**
- EWC Epoxy Wall Coating
  - HPC High Performance Coating
  - PT Paint
- CEILING FINISHES LEGEND:**
- ECC Epoxy Ceiling Coating
  - HPC High Performance Coating
  - PF Prefinished
  - PT Paint
- WALL PROTECTION LEGEND:**
- ESRP Extruded Semi-Rigid PVCu Panel
  - FRL Fibre Reinforced Laminate
  - FRP Fibreglass Reinforced Plastic
  - PVV Protective Vinyl Wallcovering
  - RHIS Rigid High Impact Sheet
  - WSSP Wetwall Solid Surface Panel
  - WVV Wetroom Vinyl Wallcovering
- FLOOR FINISHES LEGEND:**
- CFS Concrete Floor Sealer
  - EFC Epoxy Floor Coating
  - PFC Polyurethane Floor Coating
  - RAF Rubber Athletic Flooring
  - RSF Rubber Sheet Flooring
  - SCF Seamless Cushioned Flooring
  - SDRF Static-Dissipative Rubber Sheet Flooring
  - SDVF Static-Dissipative Vinyl Sheet Flooring
  - VSF Vinyl Sheet Flooring
  - WSVF Wetroom Safety Vinyl Sheet Flooring
- FLOOR BASE LEGEND:**
- FCB Flash Cove Base
  - RB Rubber Base
  - SCF Seamless Cushioned Flooring

**DOORS**

Types:

Note: for Type F doors, the door panels will be approximately 465/1065 unless otherwise required by the Authority

Type	Qty	Size (mm)	Material	Finish	Side Lt	Blinds	Protect	Privacy Film	Function	Card Reader	Mag Lock	Auto Opener	Hold Open	Hinges	Accessory 1	Accessory 2	Accessory 3	Closer
F	1	1530 x 2135	Solid Core	FRL	<input type="checkbox"/>	<input type="checkbox"/>	2 High	<input type="checkbox"/>	Storeroom	<input checked="" type="checkbox"/>	<input type="checkbox"/>	<input type="checkbox"/>	<input checked="" type="checkbox"/>	Butt Hinge	Astragal	Flush Bolt		Concealed

**FINISHES**

Full-height Cabinet:

Upper Millwork:

Countertop:

Lower Millwork:

Shelf:

Remarks:

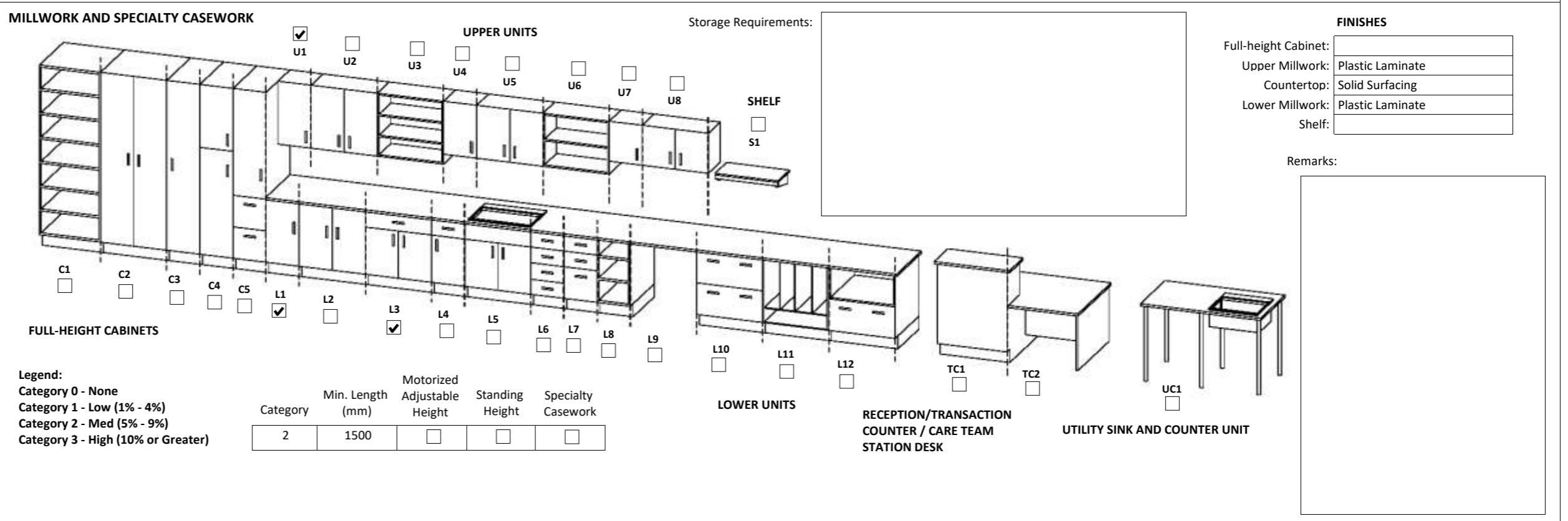

**MECHANICAL REQUIREMENTS**

**PLUMBING**

Hand Hygiene Sink:	Lavatory:	Kitchen Sink:	Seamless Kitchen Sink:	Utility / Process Sink:	Scrub Sink:	Floor Sink:
1						

Plumbing Remarks:

**Other Fixtures:**

- Shower
- Tub
- Ice Maker
- Water Closet
- Instantaneous Hot Water
- Eyewash Station
- Eyewash/Shower Station
- Emergency Shower
- Flush Rim Sink
- Floor Drain
- Water Bottle Refill Station

Other:

**MED / NON-MED GASES**

Oxygen:	Medical Air:	Medical Vacuum:	Nitrous Oxide:	CO2:	AGSS:	Nitrogen:	Laboratory Air:	Laboratory Vacuum:	Utility Compressed Air:
1	1	1							

Gas Remarks:

**Appendix 1B Minimum Room Requirements**

Room Name:

Program Number(s):

1. F6.06	7.	13.	19.	25.	31.	37.	43.
2.	8.	14.	20.	26.	32.	38.	44.
3.	9.	15.	21.	27.	33.	39.	45.
4.	10.	16.	22.	28.	34.	40.	46.
5.	11.	17.	23.	29.	35.	41.	47.
6.	12.	18.	24.	30.	36.	42.	48.

**ARCHITECTURAL REQUIREMENTS**

<b>WALL AND CEILING</b> Wall Material: <input type="text" value="ARGB 1.2m AFF, GB above"/> Finish: <input type="text" value="PT"/> Ceiling Material: <input type="text" value="ACT"/> Finish: <input type="text" value="PF"/>	<b>WALL PROTECTION</b> Type: <input type="text" value="ESRP"/> <input checked="" type="checkbox"/> Corner Guards <input type="checkbox"/> Hand Rails <input type="checkbox"/> Bed Bumper / Locator Height: <input type="text" value="1600 mm"/> <input type="checkbox"/> Crash Rails <input type="checkbox"/> Chair Rail	<b>GLAZING</b> <input type="checkbox"/> Interior Glazing	<b>FLOORING TYPES</b> Material: <input type="text" value="VSF"/> Base: <input type="text" value="FCB"/>	<b>ROOM ACCESSORIES</b> <input type="checkbox"/> Coat Hooks <input type="checkbox"/> Ceiling Lift <input type="checkbox"/> Magnetic Whiteboard <input type="checkbox"/> Mirror <input type="checkbox"/> Infant Change Table <input type="checkbox"/> Privacy Curtain
--	--	---	--	--

- LEGEND:**
- WALL AND CEILING LEGEND:**
- AC Architectural Ceiling
  - ACT Acoustic Ceiling Tile
  - ACT-C Cleanroom
  - ARGB Abuse-Resistant Gypsum Board
  - GB Gypsum Board
  - IRGB Impact-Resistant Gypsum Board
  - KLCT Kitchen Lay-in Ceiling Tile
  - MMRGB Moisture and Mould-Resistant Gypsum Board
  - SACT Security Acoustic Ceiling Tile
- WALL FINISHES LEGEND:**
- EWC Epoxy Wall Coating
  - HPC High Performance Coating
  - PT Paint
- CEILING FINISHES LEGEND:**
- ECC Epoxy Ceiling Coating
  - HPC High Performance Coating
  - PF Prefinished
  - PT Paint
- WALL PROTECTION LEGEND:**
- ESRP Extruded Semi-Rigid PVCu Panel
  - FRL Fibre Reinforced Laminate
  - FRP Fibreglass Reinforced Plastic
  - PVV Protective Vinyl Wallcovering
  - RHIS Rigid High Impact Sheet
  - WSSP Wetwall Solid Surface Panel
  - WVV Wetroom Vinyl Wallcovering
- FLOOR FINISHES LEGEND:**
- CFS Concrete Floor Sealer
  - EFC Epoxy Floor Coating
  - PFC Polyurethane Floor Coating
  - RAF Rubber Athletic Flooring
  - RSF Rubber Sheet Flooring
  - SCF Seamless Cushioned Flooring
  - SDRF Static-Dissipative Rubber Sheet Flooring
  - SDVF Static-Dissipative Vinyl Sheet Flooring
  - VSF Vinyl Sheet Flooring
  - WSVF Wetroom Safety Vinyl Sheet Flooring
- FLOOR BASE LEGEND:**
- FCB Flash Cove Base
  - RB Rubber Base
  - SCF Seamless Cushioned Flooring

**DOORS**

Types:

Note: for Type F doors, the door panels will be approximately 465/1065 unless otherwise required by the Authority

Type	Qty	Size (mm)	Material	Finish	Side Lt.	Blinds	Protect.	Privacy Film	Function	Card Reader	Mag Lock	Auto Opener	Hold Open	Hinges	Accessory 1	Accessory 2	Accessory 3	Closer
F2	1	1830 x 2135	Solid Core	FRL	<input type="checkbox"/>	<input type="checkbox"/>	2 High	<input checked="" type="checkbox"/>	Storeroom	<input checked="" type="checkbox"/>	<input type="checkbox"/>	<input checked="" type="checkbox"/>	<input checked="" type="checkbox"/>	Cont. Swing Clear	Astragal	Flush Bolt	Elec. Strike	Surface

**Door Remarks:**

Security Grille  
 Anti-barricade strategy

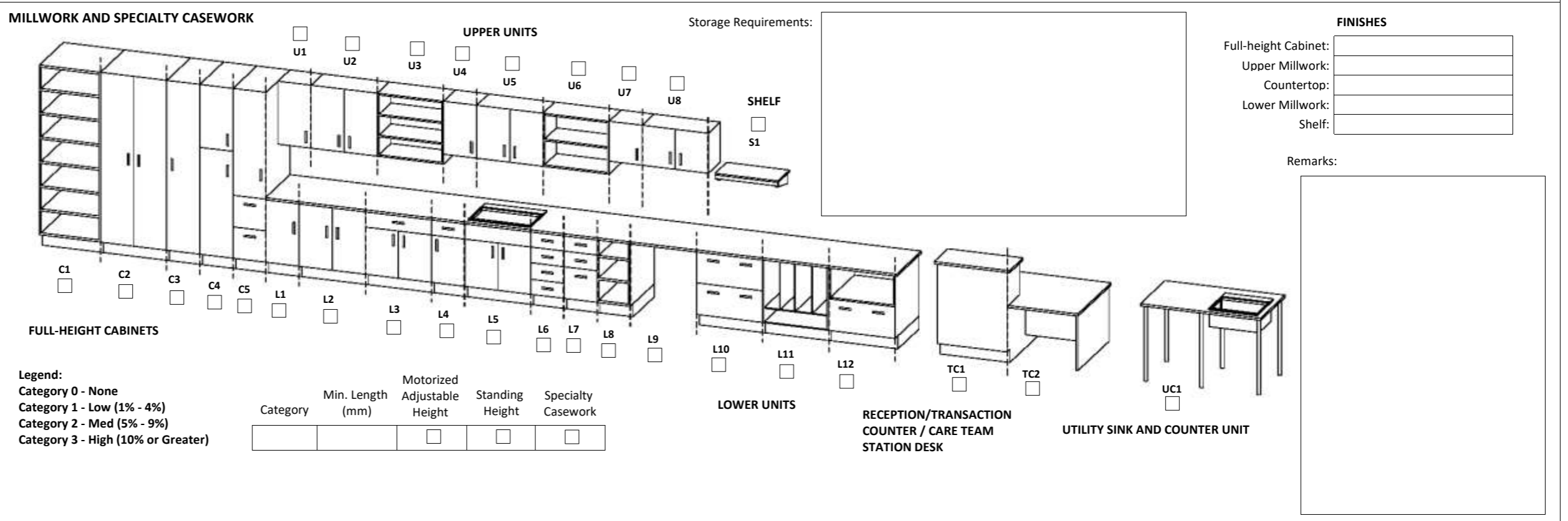

**MECHANICAL REQUIREMENTS**

<b>PLUMBING</b> (Quantity) Hand Hygiene Sink: <input type="text"/> Lavatory: <input type="text"/> Kitchen Sink: <input type="text"/> Seamless Kitchen Sink: <input type="text"/> Utility / Process Sink: <input type="text"/> Scrub Sink: <input type="text"/> Floor Sink: <input type="text"/> Plumbing Remarks: <input type="text"/>	Other Fixtures: <input type="checkbox"/> Shower <input type="checkbox"/> Tub <input type="checkbox"/> Ice Maker <input type="checkbox"/> Water Closet <input type="checkbox"/> Instantaneous Hot Water <input type="checkbox"/> Eyewash Station <input type="checkbox"/> Eyewash/Shower Station <input type="checkbox"/> Emergency Shower <input type="checkbox"/> Flush Rim Sink <input type="checkbox"/> Floor Drain <input type="checkbox"/> Water Bottle Refill Station Other: <input type="text"/>	<b>MED / NON-MED GASES</b> (Quantity) Oxygen: <input type="text"/> Medical Air: <input type="text"/> Medical Vacuum: <input type="text"/> Nitrous Oxide: <input type="text"/> CO2: <input type="text"/> AGSS: <input type="text"/> Nitrogen: <input type="text"/> Laboratory Air: <input type="text"/> Laboratory Vacuum: <input type="text"/> Utility Compressed Air: <input type="text"/> Gas Remarks: <input type="text"/>
---	---	---



**Appendix 1B Minimum Room Requirements**

Room Name:

Program Number(s):

1. F4.19	7.	13.	19.	25.	31.	37.	43.
2.	8.	14.	20.	26.	32.	38.	44.
3.	9.	15.	21.	27.	33.	39.	45.
4.	10.	16.	22.	28.	34.	40.	46.
5.	11.	17.	23.	29.	35.	41.	47.
6.	12.	18.	24.	30.	36.	42.	48.

**ARCHITECTURAL REQUIREMENTS**

<b>WALL AND CEILING</b> Wall Material: <input type="text" value="ARGB 1.2m AFF, GB above"/> Finish: <input type="text" value="EWC"/> Ceiling Material: <input type="text" value="ACT-C"/> Finish: <input type="text" value="ECC"/>	<b>WALL PROTECTION</b> Type: <input type="text" value="ESRP"/> <input checked="" type="checkbox"/> Corner Guards <input type="checkbox"/> Hand Rails <input type="checkbox"/> Bed Bumper / Locator Height: <input type="text" value="1600 mm"/> <input type="checkbox"/> Crash Rails <input type="checkbox"/> Chair Rail	<b>GLAZING</b> <input type="checkbox"/> Interior Glazing	<b>FLOORING TYPES</b> Material: <input type="text" value="VSF"/> Base: <input type="text" value="FCB"/>	<b>ROOM ACCESSORIES</b> <input type="checkbox"/> Coat Hooks <input type="checkbox"/> Ceiling Lift <input type="checkbox"/> Magnetic Whiteboard <input type="checkbox"/> Mirror <input type="checkbox"/> Infant Change Table <input type="checkbox"/> Privacy Curtain
--	--	---	--	--

- LEGEND:**
- WALL AND CEILING LEGEND:**
- AC Architectural Ceiling
  - ACT Acoustic Ceiling Tile
  - ACT-C Cleanroom
  - ARGB Abuse-Resistant Gypsum Board
  - GB Gypsum Board
  - IRGB Impact-Resistant Gypsum Board
  - KLCT Kitchen Lay-in Ceiling Tile
  - MMRGB Moisture and Mould-Resistant Gypsum Board
  - SACT Security Acoustic Ceiling Tile
- WALL FINISHES LEGEND:**
- EWC Epoxy Wall Coating
  - HPC High Performance Coating
  - PT Paint
- CEILING FINISHES LEGEND:**
- ECC Epoxy Ceiling Coating
  - HPC High Performance Coating
  - PF Prefinished
  - PT Paint
- WALL PROTECTION LEGEND:**
- ESRP Extruded Semi-Rigid PVCu Panel
  - FRL Fibre Reinforced Laminate
  - FRP Fibreglass Reinforced Plastic
  - PVV Protective Vinyl Wallcovering
  - RHIS Rigid High Impact Sheet
  - WSSP Wetwall Solid Surface Panel
  - WVV Wetroom Vinyl Wallcovering
- FLOOR FINISHES LEGEND:**
- CFS Concrete Floor Sealer
  - EFC Epoxy Floor Coating
  - PFC Polyurethane Floor Coating
  - RAF Rubber Athletic Flooring
  - RSF Rubber Sheet Flooring
  - SCF Seamless Cushioned Flooring
  - SDRF Static-Dissipative Rubber Sheet Flooring
  - SDVF Static-Dissipative Vinyl Sheet Flooring
  - VSF Vinyl Sheet Flooring
  - WSVF Wetroom Safety Vinyl Sheet Flooring
- FLOOR BASE LEGEND:**
- FCB Flash Cove Base
  - RB Rubber Base
  - SCF Seamless Cushioned Flooring

**DOORS**

Types:

Type	Qty	Size (mm)	Material	Finish	Side Lt.	Blinds	Protect.	Privacy Film	Function	Card Reader	Mag Lock	Auto Opener	Hold Open	Hinges	Accessory 1	Accessory 2	Accessory 3	Closer
C	1	1220 x 2135	Solid Core	FRL	<input type="checkbox"/>	<input type="checkbox"/>	2 High	<input type="checkbox"/>	Storeroom	<input checked="" type="checkbox"/>	<input type="checkbox"/>	<input type="checkbox"/>	<input checked="" type="checkbox"/>	Cont. Swing Clear				Surface

Door Remarks:  Security Grille  Anti-barricade strategy



**MECHANICAL REQUIREMENTS**

<b>PLUMBING</b> (Quantity) Hand Hygiene Sink: <input type="text"/> Lavatory: <input type="text"/> Kitchen Sink: <input type="text"/> Seamless Kitchen Sink: <input type="text"/> Utility / Process Sink: <input type="text"/> Scrub Sink: <input type="text"/> Floor Sink: <input type="text"/> Plumbing Remarks: <input type="text"/>	Other Fixtures: <input type="checkbox"/> Shower <input type="checkbox"/> Eyewash Station <input type="checkbox"/> Tub <input type="checkbox"/> Eyewash/Shower Station <input type="checkbox"/> Ice Maker <input type="checkbox"/> Emergency Shower <input type="checkbox"/> Water Closet <input type="checkbox"/> Flush Rim Sink <input type="checkbox"/> Instantaneous Hot Water <input type="checkbox"/> Floor Drain <input type="checkbox"/> <input type="checkbox"/> Water Bottle Refill Station Other <input type="text"/>	<b>MED / NON-MED GASES</b> (Quantity) Oxygen: <input type="text"/> Medical Air: <input type="text"/> Medical Vacuum: <input type="text"/> Nitrous Oxide: <input type="text"/> CO2: <input type="text"/> AGSS: <input type="text"/> Nitrogen: <input type="text"/> Laboratory Air: <input type="text"/> Laboratory Vacuum: <input type="text"/> Utility Compressed Air: <input type="text"/> Gas Remarks: <input type="text"/>
---	--	---

**Appendix 1B Minimum Room Requirements**

Room Name:

Program Number(s):

1. F2.12	7.	13.	19.	25.	31.	37.	43.
2. F3.07	8.	14.	20.	26.	32.	38.	44.
3.	9.	15.	21.	27.	33.	39.	45.
4.	10.	16.	22.	28.	34.	40.	46.
5.	11.	17.	23.	29.	35.	41.	47.
6.	12.	18.	24.	30.	36.	42.	48.

**ARCHITECTURAL REQUIREMENTS**

<b>WALL AND CEILING</b> Wall Material: <input type="text" value="ARGB 1.2m AFF, GB above"/> Finish: <input type="text" value="PT"/> Ceiling Material: <input type="text" value="GB"/> Finish: <input type="text" value="ECC"/>		<b>WALL PROTECTION</b> Type: <input type="text" value="ESRP"/> <input checked="" type="checkbox"/> Corner Guards <input type="checkbox"/> Hand Rails <input type="checkbox"/> Bed Bumper / Locator Height: <input type="text" value="2185 mm"/> <input type="checkbox"/> Crash Rails <input type="checkbox"/> Chair Rail		<b>GLAZING</b> <input type="checkbox"/> Interior Glazing		<b>FLOORING TYPES</b> Material: <input type="text" value="SDRF"/> Base: <input type="text" value="FCB"/>		<b>ROOM ACCESSORIES</b> <input checked="" type="checkbox"/> Coat Hooks <input checked="" type="checkbox"/> Ceiling Lift <input checked="" type="checkbox"/> Magnetic Whiteboard <input type="checkbox"/> Mirror <input type="checkbox"/> Infant Change Table <input checked="" type="checkbox"/> Privacy Curtain	
--	--	--	--	---	--	---	--	--	--

- LEGEND:**
- WALL AND CEILING LEGEND:**
- AC Architectural Ceiling
  - ACT Acoustic Ceiling Tile
  - ACT-C Cleanroom
  - ARGB Abuse-Resistant Gypsum Board
  - GB Gypsum Board
  - IRGB Impact-Resistant Gypsum Board
  - KLCT Kitchen Lay-in Ceiling Tile
  - MMRGB Moisture and Mould-Resistant Gypsum Board
  - SACT Security Acoustic Ceiling Tile
- WALL FINISHES LEGEND:**
- EWC Epoxy Wall Coating
  - HPC High Performance Coating
  - PT Paint
- CEILING FINISHES LEGEND:**
- ECC Epoxy Ceiling Coating
  - HPC High Performance Coating
  - PF Prefinished
  - PT Paint
- WALL PROTECTION LEGEND:**
- ESRP Extruded Semi-Rigid PVCu Panel
  - FRL Fibre Reinforced Laminated
  - FRP Fibreglass Reinforced Plastic
  - PVV Protective Vinyl Wallcovering
  - RHIS Rigid High Impact Sheet
  - WSSP Wetwall Solid Surface Panel
  - WVV Wetroom Vinyl Wallcovering
- FLOOR FINISHES LEGEND:**
- CFS Concrete Floor Sealer
  - EFC Epoxy Floor Coating
  - PFC Polyurethane Floor Coating
  - RAF Rubber Athletic Flooring
  - RSF Rubber Sheet Flooring
  - SCF Seamless Cushioned Flooring
  - SDRF Static-Dissipative Rubber Sheet Flooring
  - SDVF Static-Dissipative Vinyl Sheet Flooring
  - VSF Vinyl Sheet Flooring
  - WSVF Wetroom Safety Vinyl Sheet Flooring
- FLOOR BASE LEGEND:**
- FCB Flash Cove Base
  - RB Rubber Base
  - SCF Seamless Cushioned Flooring

**DOORS**

Types:

Note: for Type F doors, the door panels will be approximately 465/1065 unless otherwise required by the Authority

Type	Qty	Size (mm)	Material	Finish	Side Lt.	Blinds	Protect.	Privacy Film	Function	Card Reader	Mag Lock	Auto Opener	Hold Open	Hinges	Accessory 1	Accessory 2	Accessory 3	Closer
F	1	1530 x 2135	Solid Core	FRL	<input type="checkbox"/>	<input type="checkbox"/>	2 High	<input type="checkbox"/>	Storeroom	<input checked="" type="checkbox"/>	<input type="checkbox"/>	<input type="checkbox"/>	<input checked="" type="checkbox"/>	Butt Hinge	Astragal	Flush Bolt		Concealed

**Door Remarks:**

Security Grille  
 Anti-barricade strategy

**MILLWORK AND SPECIALTY CASEWORK**

Storage Requirements:

**UPPER UNITS:** U1, U2, U3, U4, U5, U6, U7, U8

**LOWER UNITS:** L1, L2, L3, L4, L5, L6, L7, L8, L9, L10, L11, L12

**RECEPTION/TRANSACTION COUNTER / CARE TEAM STATION DESK:** TC1, TC2

**UTILITY SINK AND COUNTER UNIT:** UC1

**SHELF:** S1

**FULL-HEIGHT CABINETS:** C1, C2, C3, C4, C5

**Legend:**

Category	Min. Length (mm)	Motorized Adjustable Height	Standing Height	Specialty Casework
2	2100	<input type="checkbox"/>	<input type="checkbox"/>	<input type="checkbox"/>

**FINISHES**

Full-height Cabinet:   
 Upper Millwork:   
 Countertop:   
 Lower Millwork:   
 Shelf:

Remarks:  
 Refer to Appendix 1H [Equipment and Furniture] for ceiling lift quantities

**MECHANICAL REQUIREMENTS**

<b>PLUMBING</b> (Quantity)							<b>MED / NON-MED GASES</b> (Quantity)									
Hand Hygiene Sink:	Lavatory:	Kitchen Sink:	Seamless Kitchen Sink:	Utility / Process Sink:	Scrub Sink:	Floor Sink:	Oxygen:	Medical Air:	Medical Vacuum:	Nitrous Oxide:	CO2:	AGSS:	Nitrogen:	Laboratory Air:	Laboratory Vacuum:	Utility Compressed Air:
1							1	1	1							
Plumbing Remarks: <input type="text"/>							Gas Remarks: <input type="text"/>									

**Other Fixtures:**

- Shower
- Tub
- Ice Maker
- Water Closet
- Instantaneous Hot Water
- Eyewash Station
- Eyewash/Shower Station
- Emergency Shower
- Flush Rim Sink
- Floor Drain
- Water Bottle Refill Station

Other:

**Appendix 1B Minimum Room Requirements**

Room Name:

Program Number(s):

1. F7.08	7.	13.	19.	25.	31.	37.	43.
2.	8.	14.	20.	26.	32.	38.	44.
3.	9.	15.	21.	27.	33.	39.	45.
4.	10.	16.	22.	28.	34.	40.	46.
5.	11.	17.	23.	29.	35.	41.	47.
6.	12.	18.	24.	30.	36.	42.	48.

**ARCHITECTURAL REQUIREMENTS**

<b>WALL AND CEILING</b> Wall Material: <input type="text" value="ARGB 1.2m AFF, GB above"/> Finish: <input type="text" value="PT"/> Ceiling Material: <input type="text" value="ACT"/> Finish: <input type="text" value="PF"/>		<b>WALL PROTECTION</b> Type: <input type="text" value="RHIS"/> <input checked="" type="checkbox"/> Corner Guards <input type="checkbox"/> Hand Rails <input type="checkbox"/> Bed Bumper / Locator Height: <input type="text" value="1350 mm"/> <input type="checkbox"/> Crash Rails <input checked="" type="checkbox"/> Chair Rail			<b>GLAZING</b> <input checked="" type="checkbox"/> Interior Glazing		<b>FLOORING TYPES</b> Material: <input type="text" value="VSF"/> Base: <input type="text" value="FCB"/>		<b>ROOM ACCESSORIES</b> <input checked="" type="checkbox"/> Coat Hooks <input checked="" type="checkbox"/> Ceiling Lift <input checked="" type="checkbox"/> Magnetic Whiteboard <input type="checkbox"/> Mirror <input type="checkbox"/> Infant Change Table <input type="checkbox"/> Privacy Curtain		
--	--	---	--	--	--	--	--	--	---	--	--

- LEGEND:**
- WALL AND CEILING LEGEND:**
- AC Architectural Ceiling
  - ACT Acoustic Ceiling Tile
  - ACT-C Cleanroom
  - ARGB Abuse-Resistant Gypsum Board
  - GB Gypsum Board
  - IRGB Impact-Resistant Gypsum Board
  - KLCT Kitchen Lay-in Ceiling Tile
  - MMRGB Moisture and Mould-Resistant Gypsum Board
  - SACT Security Acoustic Ceiling Tile
- WALL FINISHES LEGEND:**
- EWC Epoxy Wall Coating
  - HPC High Performance Coating
  - PT Paint
- CEILING FINISHES LEGEND:**
- ECC Epoxy Ceiling Coating
  - HPC High Performance Coating
  - PF Prefinished
  - PT Paint
- WALL PROTECTION LEGEND:**
- ESRP Extruded Semi-Rigid PVCu Panel
  - FRL Fibre Reinforced Laminate
  - FRP Fibreglass Reinforced Plastic
  - PVV Protective Vinyl Wallcovering
  - RHIS Rigid High Impact Sheet
  - WSSP Wetwall Solid Surface Panel
  - WVV Wetroom Vinyl Wallcovering
- FLOOR FINISHES LEGEND:**
- CFS Concrete Floor Sealer
  - EFC Epoxy Floor Coating
  - PFC Polyurethane Floor Coating
  - RAF Rubber Athletic Flooring
  - RSF Rubber Sheet Flooring
  - SCF Seamless Cushioned Flooring
  - SDRF Static-Dissipative Rubber Sheet Flooring
  - SDVF Static-Dissipative Vinyl Sheet Flooring
  - VSF Vinyl Sheet Flooring
  - WSVF Wetroom Safety Vinyl Sheet Flooring
- FLOOR BASE LEGEND:**
- FCB Flash Cove Base
  - RB Rubber Base
  - SCF Seamless Cushioned Flooring

**DOORS**

Types:

Note: for Type F doors, the door panels will be approximately 465/1065 unless otherwise required by the Authority

Type	Qty	Size (mm)	Material	Finish	Side Lt.	Blinds	Protect.	Privacy Film	Function	Card Reader	Mag Lock	Auto Opener	Hold Open	Hinges	Accessory 1	Accessory 2	Accessory 3	Closer
F2	1	1530 x 2135	Hollow Metal	Paint	<input type="checkbox"/>	<input type="checkbox"/>		<input type="checkbox"/>	Storeroom	<input checked="" type="checkbox"/>	<input type="checkbox"/>	<input checked="" type="checkbox"/>	<input checked="" type="checkbox"/>	Butt Hinge	Astragal	Flush Bolt		Surface

**DOOR REMARKS:**

Security Grille  
 Anti-barricade strategy

**MILLWORK AND SPECIALTY CASEWORK**

Storage Requirements:

**UPPER UNITS:** U1, U2, U3, U4, U5, U6, U7, U8

**LOWER UNITS:** L1, L2, L3, L4, L5, L6, L7, L8, L9, L10, L11, L12

**RECEPTION/TRANSACTION COUNTER / CARE TEAM STATION DESK:** TC1, TC2

**UTILITY SINK AND COUNTER UNIT:** UC1

**SHELF:** S1

**FULL-HEIGHT CABINETS:** C1, C2, C3, C4, C5

**Legend:**

Category	Min. Length (mm)	Motorized Adjustable Height	Standing Height	Specialty Casework
3	4800	<input type="checkbox"/>	<input checked="" type="checkbox"/>	<input type="checkbox"/>

**FINISHES**

Full-height Cabinet:   
 Upper Millwork:   
 Countertop:   
 Lower Millwork:   
 Shelf:

**REMARKS:**

Workroom to provide (2) workbenches and to accommodate parts storage, ceiling mounted chain hoist and floor lift equipment

**MECHANICAL REQUIREMENTS**

<b>PLUMBING</b> (Quantity) Hygiene Sink: <input type="text" value="1"/> Lavatory: <input type="text"/> Kitchen Sink: <input type="text"/> Kitchen Sink: <input type="text"/> Utility / Process Sink: <input type="text" value="1"/> Scrub Sink: <input type="text"/> Floor Sink: <input type="text"/>							Other Fixtures: <input type="checkbox"/> Shower <input type="checkbox"/> Tub <input type="checkbox"/> Ice Maker <input type="checkbox"/> Water Closet <input type="checkbox"/> Instantaneous Hot Water				<input checked="" type="checkbox"/> Eyewash Station <input type="checkbox"/> Eyewash/Shower Station <input type="checkbox"/> Emergency Shower <input checked="" type="checkbox"/> Flush Rim Sink <input checked="" type="checkbox"/> Floor Drain <input type="checkbox"/> Water Bottle Refill Station Other: <input type="text"/>				<b>MED / NON-MED GASES</b> (Quantity) Oxygen: <input type="text"/> Medical Air: <input type="text"/> Medical Vacuum: <input type="text"/> Nitrous Oxide: <input type="text"/> CO2: <input type="text"/> AGSS: <input type="text"/> Nitrogen: <input type="text"/> Laboratory Air: <input type="text"/> Laboratory Vacuum: <input type="text"/> Utility Compressed Air: <input type="text" value="2"/>					
Plumbing Remarks: <input type="text" value="Provide hose bibb"/>											Gas Remarks: <input type="text"/>									



---

# New Surrey Hospital & BC Cancer Centre

MINIMUM ROOM REQUIREMENTS

**G. Oncology Ambulatory Care Unit**

---

# Appendix 1B Minimum Room Requirements

Room Name:

Program Number(s):

1. G1.06	7.	13.	19.	25.	31.	37.	43.
2.	8.	14.	20.	26.	32.	38.	44.
3.	9.	15.	21.	27.	33.	39.	45.
4.	10.	16.	22.	28.	34.	40.	46.
5.	11.	17.	23.	29.	35.	41.	47.
6.	12.	18.	24.	30.	36.	42.	48.

## ARCHITECTURAL REQUIREMENTS

<b>WALL AND CEILING</b> Wall Material: <input type="text" value="ARGB 1.2m AFF, GB above"/> Finish: <input type="text" value="EWC"/> Ceiling Material: <input type="text" value="ARGB"/> Finish: <input type="text" value="ECC"/>	<b>WALL PROTECTION</b> Type: <input type="text" value="PVW"/> <input checked="" type="checkbox"/> Corner Guards <input type="checkbox"/> Hand Rails <input type="checkbox"/> Bed Bumper / Locator Height: <input type="text" value="1350 mm"/> <input type="checkbox"/> Crash Rails <input checked="" type="checkbox"/> Chair Rail	<b>GLAZING</b> <input type="checkbox"/> Interior Glazing	<b>FLOORING TYPES</b> Material: <input type="text" value="RSF"/> Base: <input type="text" value="FCB"/>	<b>ROOM ACCESSORIES</b> <input type="checkbox"/> Coat Hooks <input type="checkbox"/> Ceiling Lift <input checked="" type="checkbox"/> Magnetic Whiteboard <input type="checkbox"/> Mirror <input type="checkbox"/> Infant Change Table <input type="checkbox"/> Privacy Curtain
---	--	---	--	---

- LEGEND:**
- WALL AND CEILING LEGEND:**
- AC Architectural Ceiling
  - ACT Acoustic Ceiling Tile
  - ACT-C Cleanroom
  - ARGB Abuse-Resistant Gypsum Board
  - GB Gypsum Board
  - IRGB Impact-Resistant Gypsum Board
  - KLCT Kitchen Lay-in Ceiling Tile
  - MMRGB Moisture and Mould-Resistant Gypsum Board
  - SACT Security Acoustic Ceiling Tile
- WALL FINISHES LEGEND:**
- EWC Epoxy Wall Coating
  - HPC High Performance Coating
  - PT Paint
- CEILING FINISHES LEGEND:**
- ECC Epoxy Ceiling Coating
  - HPC High Performance Coating
  - PF Prefinished
  - PT Paint
- WALL PROTECTION LEGEND:**
- ESRP Extruded Semi-Rigid PVCu Panel
  - FRL Fibre Reinforced Laminate
  - FRP Fibreglass Reinforced Plastic
  - PVW Protective Vinyl Wallcovering
  - RHIS Rigid High Impact Sheet
  - WSSP Wetwall Solid Surface Panel
  - WVV Wetroom Vinyl Wallcovering
- FLOOR FINISHES LEGEND:**
- CFS Concrete Floor Sealer
  - EFC Epoxy Floor Coating
  - PFC Polyurethane Floor Coating
  - RAF Rubber Athletic Flooring
  - RSF Rubber Sheet Flooring
  - SCF Seamless Cushioned Flooring
  - SDRF Static-Dissipative Rubber Sheet Flooring
  - SDVF Static-Dissipative Vinyl Sheet Flooring
  - VSF Vinyl Sheet Flooring
  - WSVF Wetroom Safety Vinyl Sheet Flooring
- FLOOR BASE LEGEND:**
- FCB Flash Cove Base
  - RB Rubber Base
  - SCF Seamless Cushioned Flooring

**DOORS**

Types:

Type	Qty	Size (mm)	Material	Finish	Side Lt.	Blinds	Protect.	Privacy Film	Function	Card Reader	Mag Lock	Auto Opener	Hold Open	Hinges	Accessory 1	Accessory 2	Accessory 3	Closer
C	1	1220 x 2135	Solid Core	FRL	<input type="checkbox"/>	<input type="checkbox"/>	1 Low	<input type="checkbox"/>	Storeroom	<input checked="" type="checkbox"/>	<input type="checkbox"/>	<input type="checkbox"/>	<input type="checkbox"/>	Butt Hinge				Surface

Door Remarks:  Security Grille  Anti-barricade strategy



## MECHANICAL REQUIREMENTS

<b>PLUMBING</b> (Quantity) Hand Hygiene Sink: <input type="text" value="1"/> Lavatory: <input type="text"/> Kitchen Sink: <input type="text"/> Seamless Kitchen Sink: <input type="text"/> Utility / Process Sink: <input type="text"/> Scrub Sink: <input type="text"/> Floor Sink: <input type="text"/> Plumbing Remarks: <input type="text"/>	Other Fixtures: <input type="checkbox"/> Shower <input type="checkbox"/> Eyewash Station <input type="checkbox"/> Tub <input type="checkbox"/> Eyewash/Shower Station <input type="checkbox"/> Ice Maker <input type="checkbox"/> Emergency Shower <input type="checkbox"/> Water Closet <input type="checkbox"/> Flush Rim Sink <input type="checkbox"/> Instantaneous Hot Water <input type="checkbox"/> Floor Drain <input type="checkbox"/> <input type="checkbox"/> Water Bottle Refill Station Other: <input type="text"/>	<b>MED / NON-MED GASES</b> (Quantity) Oxygen: <input type="text"/> Medical Air: <input type="text"/> Medical Vacuum: <input type="text"/> Nitrous Oxide: <input type="text"/> CO2: <input type="text"/> AGSS: <input type="text"/> Nitrogen: <input type="text"/> Laboratory Air: <input type="text"/> Laboratory Vacuum: <input type="text"/> Utility Compressed Air: <input type="text"/> Gas Remarks: <input type="text"/>
---	---	---

**Appendix 1B Minimum Room Requirements**

Room Name:

Program Number(s):

1. G2.01	7.	13.	19.	25.	31.	37.	43.
2.	8.	14.	20.	26.	32.	38.	44.
3.	9.	15.	21.	27.	33.	39.	45.
4.	10.	16.	22.	28.	34.	40.	46.
5.	11.	17.	23.	29.	35.	41.	47.
6.	12.	18.	24.	30.	36.	42.	48.

**ARCHITECTURAL REQUIREMENTS**

<b>WALL AND CEILING</b> Wall Material: <input type="text" value="ARGB 1.2m AFF, GB above"/> Finish: <input type="text" value="PT"/> Ceiling Material: <input type="text" value="ACT"/> Finish: <input type="text" value="PF"/>	<b>WALL PROTECTION</b> Type: <input type="text" value="PVW"/> <input type="checkbox"/> Corner Guards <input type="checkbox"/> Hand Rails <input type="checkbox"/> Bed Bumper / Locator Height: <input type="text" value="1600 mm"/> <input type="checkbox"/> Crash Rails <input type="checkbox"/> Chair Rail	<b>GLAZING</b> <input type="checkbox"/> Interior Glazing	<b>FLOORING TYPES</b> Material: <input type="text" value="VSF"/> Base: <input type="text" value="FCB"/>	<b>ROOM ACCESSORIES</b> <input checked="" type="checkbox"/> Coat Hooks <input checked="" type="checkbox"/> Ceiling Lift <input checked="" type="checkbox"/> Magnetic Whiteboard <input checked="" type="checkbox"/> Mirror <input type="checkbox"/> Infant Change Table <input checked="" type="checkbox"/> Privacy Curtain
--	--	---	--	---

- LEGEND:**
- WALL AND CEILING LEGEND:**
- AC Architectural Ceiling
  - ACT Acoustic Ceiling Tile
  - ACT-C Cleanroom
  - ARGB Abuse-Resistant Gypsum Board
  - GB Gypsum Board
  - IRGB Impact-Resistant Gypsum Board
  - KLCT Kitchen Lay-in Ceiling Tile
  - MMRGB Moisture and Mould-Resistant Gypsum Board
  - SACT Security Acoustic Ceiling Tile
- WALL FINISHES LEGEND:**
- EWC Epoxy Wall Coating
  - HPC High Performance Coating
  - PT Paint
- CEILING FINISHES LEGEND:**
- ECC Epoxy Ceiling Coating
  - HPC High Performance Coating
  - PF Prefinished
  - PT Paint
- WALL PROTECTION LEGEND:**
- ESRP Extruded Semi-Rigid PVCu Panel
  - FRL Fibre Reinforced Laminate
  - FRP Fibreglass Reinforced Plastic
  - PVW Protective Vinyl Wallcovering
  - RHIS Rigid High Impact Sheet
  - WSSP Wetwall Solid Surface Panel
  - WVV Wetroom Vinyl Wallcovering
- FLOOR FINISHES LEGEND:**
- CFS Concrete Floor Sealer
  - EFC Epoxy Floor Coating
  - PFC Polyurethane Floor Coating
  - RAF Rubber Athletic Flooring
  - RSF Rubber Sheet Flooring
  - SCF Seamless Cushioned Flooring
  - SDRF Static-Dissipative Rubber Sheet Flooring
  - SDVF Static-Dissipative Vinyl Sheet Flooring
  - VSF Vinyl Sheet Flooring
  - WSVF Wetroom Safety Vinyl Sheet Flooring
- FLOOR BASE LEGEND:**
- FCB Flash Cove Base
  - RB Rubber Base
  - SCF Seamless Cushioned Flooring

**DOORS**

Types:

Type	Qty	Size (mm)	Material	Finish	Side Lt.	Blinds	Protect.	Privacy Film	Function	Card Reader	Mag Lock	Auto Opener	Hold Open	Hinges	Accessory 1	Accessory 2	Accessory 3	Closer

Door Remarks:  Security Grille  Anti-barricade strategy

**MILLWORK AND SPECIALTY CASEWORK**

**UPPER UNITS** (U1-U8) **LOWER UNITS** (L1-L12) **RECEPTION/TRANSACTION COUNTER / CARE TEAM STATION DESK** (TC1-TC2) **UTILITY SINK AND COUNTER UNIT** (UC1)

Storage Requirements:

**FINISHES**

Full-height Cabinet:   
 Upper Millwork:   
 Countertop:   
 Lower Millwork:   
 Shelf:

Remarks:

**Legend:**

Category	Min. Length (mm)	Motorized Adjustable Height	Standing Height	Specialty Casework
Category 0 - None				
Category 1 - Low (1% - 4%)				
Category 2 - Med (5% - 9%)				
Category 3 - High (10% or Greater)				

**MECHANICAL REQUIREMENTS**

<b>PLUMBING</b> (Quantity) Hand Hygiene Sink: <input type="text"/> Lavatory: <input type="text"/> Kitchen Sink: <input type="text"/> Seamless Kitchen Sink: <input type="text"/> Utility / Process Sink: <input type="text"/> Scrub Sink: <input type="text"/> Floor Sink: <input type="text"/> Plumbing Remarks: <input type="text"/>	Other Fixtures: <input type="checkbox"/> Shower <input type="checkbox"/> Eyewash Station <input type="checkbox"/> Tub <input type="checkbox"/> Eyewash/Shower Station <input type="checkbox"/> Ice Maker <input type="checkbox"/> Emergency Shower <input type="checkbox"/> Water Closet <input type="checkbox"/> Flush Rim Sink <input type="checkbox"/> Instantaneous Hot Water <input type="checkbox"/> Floor Drain <input type="checkbox"/> <input type="checkbox"/> Water Bottle Refill Station Other <input type="text"/>	<b>MED / NON-MED GASES</b> (Quantity) Oxygen: <input type="text" value="1"/> Medical Air: <input type="text" value="1"/> Medical Vacuum: <input type="text"/> Nitrous Oxide: <input type="text"/> CO2: <input type="text"/> AGSS: <input type="text"/> Nitrogen: <input type="text"/> Laboratory Air: <input type="text"/> Laboratory Vacuum: <input type="text"/> Utility Compressed Air: <input type="text"/> Gas Remarks: <input type="text" value="Provide one set of (1) O2/(1) Medical Air per bay to Patient's right."/>
---	--	--



# Appendix 1B Minimum Room Requirements

Room Name:

Program Number(s):

1.	G3.05	7.		13.		19.		25.		31.		37.		43.
2.		8.		14.		20.		26.		32.		38.		44.
3.		9.		15.		21.		27.		33.		39.		45.
4.		10.		16.		22.		28.		34.		40.		46.
5.		11.		17.		23.		29.		35.		41.		47.
6.		12.		18.		24.		30.		36.		42.		48.

## ARCHITECTURAL REQUIREMENTS

<b>WALL AND CEILING</b> Wall Material: <input type="text" value="ARGB 1.2m AFF, GB above"/> Finish: <input type="text" value="PT"/> Ceiling Material: <input type="text" value="ACT"/> Finish: <input type="text" value="PF"/>		<b>WALL PROTECTION</b> Type: <input type="text" value="PVW"/> <input checked="" type="checkbox"/> Corner Guards <input type="checkbox"/> Hand Rails <input type="checkbox"/> Bed Bumper / Locator Height: <input type="text" value="1350 mm"/> <input type="checkbox"/> Crash Rails <input checked="" type="checkbox"/> Chair Rail			<b>GLAZING</b> <input checked="" type="checkbox"/> Interior Glazing		<b>FLOORING TYPES</b> Material: <input type="text" value="VSF"/> Base: <input type="text" value="FCB"/>		<b>ROOM ACCESSORIES</b> <input checked="" type="checkbox"/> Coat Hooks <input type="checkbox"/> Ceiling Lift <input checked="" type="checkbox"/> Magnetic Whiteboard <input type="checkbox"/> Mirror <input type="checkbox"/> Infant Change Table <input type="checkbox"/> Privacy Curtain		
--	--	--	--	--	--	--	--	--	--	--	--

- LEGEND:**
- WALL AND CEILING LEGEND:**
- AC Architectural Ceiling
  - ACT Acoustic Ceiling Tile
  - ACT-C Cleanroom
  - ARGB Abuse-Resistant Gypsum Board
  - GB Gypsum Board
  - IRGB Impact-Resistant Gypsum Board
  - KLCT Kitchen Lay-in Ceiling Tile
  - MMRGB Moisture and Mould-Resistant Gypsum Board
  - SACT Security Acoustic Ceiling Tile
- WALL FINISHES LEGEND:**
- EWC Epoxy Wall Coating
  - HPC High Performance Coating
  - PT Paint
- CEILING FINISHES LEGEND:**
- ECC Epoxy Ceiling Coating
  - HPC High Performance Coating
  - PF Prefinished
  - PT Paint
- WALL PROTECTION LEGEND:**
- ESRP Extruded Semi-Rigid PVCu Panel
  - FRL Fibre Reinforced Laminate
  - FRP Fibreglass Reinforced Plastic
  - PVW Protective Vinyl Wallcovering
  - RHIS Rigid High Impact Sheet
  - WSSP Wetwall Solid Surface Panel
  - WVV Wetroom Vinyl Wallcovering
- FLOOR FINISHES LEGEND:**
- CFS Concrete Floor Sealer
  - EFC Epoxy Floor Coating
  - PFC Polyurethane Floor Coating
  - RAF Rubber Athletic Flooring
  - RSF Rubber Sheet Flooring
  - SCF Seamless Cushioned Flooring
  - SDRF Static-Dissipative Rubber Sheet Flooring
  - SDVF Static-Dissipative Vinyl Sheet Flooring
  - VSF Vinyl Sheet Flooring
  - WSVF Wetroom Safety Vinyl Sheet Flooring
- FLOOR BASE LEGEND:**
- FCB Flash Cove Base
  - RB Rubber Base
  - SCF Seamless Cushioned Flooring

**DOORS**

Types:

Type	Qty	Size (mm)	Material	Finish	Side Lt.	Blinds	Protect.	Privacy Film	Function	Card Reader	Mag Lock	Auto Opener	Hold Open	Hinges	Accessory 1	Accessory 2	Accessory 3	Closer
B	1	1650 x 2135	Solid Core	FRL	<input type="checkbox"/>	<input type="checkbox"/>	1 Low	<input checked="" type="checkbox"/>	Storeroom	<input checked="" type="checkbox"/>	<input type="checkbox"/>	<input type="checkbox"/>	<input checked="" type="checkbox"/>	Butt Hinge				Surface

Door Remarks:  Security Grille  Anti-barricade strategy

**MILLWORK AND SPECIALTY CASEWORK**

**UPPER UNITS** U1, U2, U3, U4, U5, U6, U7, U8

**LOWER UNITS** L1, L2, L3, L4, L5, L6, L7, L8, L9

**FULL-HEIGHT CABINETS** C1, C2, C3, C4, C5

**SHELF** S1

**RECEPTION/TRANSACTION COUNTER / CARE TEAM STATION DESK** TC1, TC2

**UTILITY SINK AND COUNTER UNIT** UC1

Storage Requirements:

**FINISHES**

Full-height Cabinet:

Upper Millwork:

Countertop:

Lower Millwork:

Shelf:

Remarks:

Category	Min. Length (mm)	Motorized Adjustable Height	Standing Height	Specialty Casework
3	2700	<input checked="" type="checkbox"/>	<input checked="" type="checkbox"/>	<input type="checkbox"/>

## MECHANICAL REQUIREMENTS

<b>PLUMBING</b> (Quantity) Hygiene Sink: <input type="text" value="1"/> Lavatory: <input type="text"/> Kitchen Sink: <input type="text"/> Seamless Kitchen Sink: <input type="text"/> Utility / Process Sink: <input type="text" value="1"/> Scrub Sink: <input type="text"/> Floor Sink: <input type="text"/>							Other Fixtures: <input type="checkbox"/> Shower <input type="checkbox"/> Tub <input type="checkbox"/> Ice Maker <input type="checkbox"/> Water Closet <input type="checkbox"/> Instantaneous Hot Water				<input type="checkbox"/> Eyewash Station <input type="checkbox"/> Eyewash/Shower Station <input type="checkbox"/> Emergency Shower <input type="checkbox"/> Flush Rim Sink <input type="checkbox"/> Floor Drain <input type="checkbox"/> Water Bottle Refill Station				<b>MED / NON-MED GASES</b> (Quantity) Oxygen: <input type="text"/> Medical Air: <input type="text"/> Medical Vacuum: <input type="text"/> Nitrous Oxide: <input type="text"/> CO2: <input type="text"/> AGSS: <input type="text"/> Nitrogen: <input type="text"/> Laboratory Air: <input type="text"/> Laboratory Vacuum: <input type="text"/> Utility Compressed Air: <input type="text"/>				
Plumbing Remarks: <input type="text"/>							Gas Remarks: <input type="text"/>												

---

# New Surrey Hospital & BC Cancer Centre

MINIMUM ROOM REQUIREMENTS

## H. Clinical Trials Unit

---

---

# New Surrey Hospital & BC Cancer Centre

MINIMUM ROOM REQUIREMENTS

## I. Systemic Therapy

---



**Appendix 1B Minimum Room Requirements**

Room Name:

Program Number(s):

1. I2.04	7.	13.	19.	25.	31.	37.	43.
2.	8.	14.	20.	26.	32.	38.	44.
3.	9.	15.	21.	27.	33.	39.	45.
4.	10.	16.	22.	28.	34.	40.	46.
5.	11.	17.	23.	29.	35.	41.	47.
6.	12.	18.	24.	30.	36.	42.	48.

**ARCHITECTURAL REQUIREMENTS**

<b>WALL AND CEILING</b> Wall Material: <input type="text" value="ARGB 1.2m AFF, GB above"/> Finish: <input type="text" value="PT"/> Ceiling Material: <input type="text" value="ACT"/> Finish: <input type="text" value="PF"/>		<b>WALL PROTECTION</b> Type: <input type="text" value="PVW"/> <input type="checkbox"/> Corner Guards <input type="checkbox"/> Hand Rails <input type="checkbox"/> Bed Bumper / Locator Height: <input type="text" value="1600 mm"/> <input type="checkbox"/> Crash Rails <input type="checkbox"/> Chair Rail		<b>GLAZING</b> <input checked="" type="checkbox"/> Interior Glazing		<b>FLOORING TYPES</b> Material: <input type="text" value="VSF"/> Base: <input type="text" value="FCB"/>		<b>ROOM ACCESSORIES</b> <input checked="" type="checkbox"/> Coat Hooks <input type="checkbox"/> Ceiling Lift <input type="checkbox"/> Magnetic Whiteboard <input type="checkbox"/> Mirror <input type="checkbox"/> Infant Change Table <input checked="" type="checkbox"/> Privacy Curtain	
--	--	--	--	--	--	--	--	--	--

- LEGEND:**
- WALL AND CEILING LEGEND:**
- AC Architectural Ceiling
  - ACT Acoustic Ceiling Tile
  - ACT-C Cleanroom
  - ARGB Abuse-Resistant Gypsum Board
  - GB Gypsum Board
  - IRGB Impact-Resistant Gypsum Board
  - KLCT Kitchen Lay-in Ceiling Tile
  - MMRGB Moisture and Mould-Resistant Gypsum Board
  - SACT Security Acoustic Ceiling Tile
- WALL FINISHES LEGEND:**
- EWC Epoxy Wall Coating
  - HPC High Performance Coating
  - PT Paint
- CEILING FINISHES LEGEND:**
- ECC Epoxy Ceiling Coating
  - HPC High Performance Coating
  - PF Prefinished
  - PT Paint
- WALL PROTECTION LEGEND:**
- ESRP Extruded Semi-Rigid PVCu Panel
  - FRL Fibre Reinforced Laminate
  - FRP Fibreglass Reinforced Plastic
  - PVW Protective Vinyl Wallcovering
  - RHIS Rigid High Impact Sheet
  - WSSP Wetwall Solid Surface Panel
  - WVV Wetroom Vinyl Wallcovering
- FLOOR FINISHES LEGEND:**
- CFS Concrete Floor Sealer
  - EFC Epoxy Floor Coating
  - PFC Polyurethane Floor Coating
  - RAF Rubber Athletic Flooring
  - RSF Rubber Sheet Flooring
  - SCF Seamless Cushioned Flooring
  - SDRF Static-Dissipative Rubber Sheet Flooring
  - SDVF Static-Dissipative Vinyl Sheet Flooring
  - VSF Vinyl Sheet Flooring
  - WSVF Wetroom Safety Vinyl Sheet Flooring
- FLOOR BASE LEGEND:**
- FCB Flash Cove Base
  - RB Rubber Base
  - SCF Seamless Cushioned Flooring

**DOORS**

Types:

Type	Qty	Size (mm)	Material	Finish	Side Lt.	Blinds	Protect.	Privacy Film	Function	Card Reader	Mag Lock	Auto Opener	Hold Open	Hinges	Accessory 1	Accessory 2	Accessory 3	Closer

Door Remarks:  Security Grille  Anti-barricade strategy

**MILLWORK AND SPECIALTY CASEWORK**

Storage Requirements:

**UPPER UNITS** (U1-U8) **SHELF** (S1)

**FULL-HEIGHT CABINETS** (C1-C5) **LOWER UNITS** (L1-L12) **RECEPTION/TRANSACTION COUNTER / CARE TEAM STATION DESK** (TC1-TC2) **UTILITY SINK AND COUNTER UNIT** (UC1)

Category	Min. Length (mm)	Motorized Adjustable Height	Standing Height	Specialty Casework

**FINISHES**

Full-height Cabinet:   
 Upper Millwork:   
 Countertop:   
 Lower Millwork:   
 Shelf:

Remarks:

**MECHANICAL REQUIREMENTS**

<b>PLUMBING</b> (Quantity) Hand Hygiene Sink: <input type="text"/> Lavatory: <input type="text"/> Kitchen Sink: <input type="text"/> Seamless Kitchen Sink: <input type="text"/> Utility / Process Sink: <input type="text"/> Scrub Sink: <input type="text"/> Floor Sink: <input type="text"/>		Other Fixtures: <input type="checkbox"/> Shower <input type="checkbox"/> Eyewash Station <input type="checkbox"/> Tub <input type="checkbox"/> Eyewash/Shower Station <input type="checkbox"/> Ice Maker <input type="checkbox"/> Emergency Shower <input type="checkbox"/> Water Closet <input type="checkbox"/> Flush Rim Sink <input type="checkbox"/> Instantaneous Hot Water <input type="checkbox"/> Floor Drain <input type="checkbox"/> Water Bottle Refill Station Other: <input type="text"/>		<b>MED / NON-MED GASES</b> (Quantity) Oxygen: <input type="text" value="1"/> Medical Air: <input type="text" value="1"/> Medical Vacuum: <input type="text"/> Nitrous Oxide: <input type="text"/> CO2: <input type="text"/> AGSS: <input type="text"/> Nitrogen: <input type="text"/> Laboratory Air: <input type="text"/> Laboratory Vacuum: <input type="text"/> Utility Compressed Air: <input type="text"/>					
Plumbing Remarks: <input type="text" value="Provide (2) HHS per treatment pod cluster"/>				Gas Remarks: <input type="text"/>					

**Appendix 1B Minimum Room Requirements**

Room Name:

Program Number(s):

1.	12.24	7.	13.	19.	25.	31.	37.	43.
2.		8.	14.	20.	26.	32.	38.	44.
3.		9.	15.	21.	27.	33.	39.	45.
4.		10.	16.	22.	28.	34.	40.	46.
5.		11.	17.	23.	29.	35.	41.	47.
6.		12.	18.	24.	30.	36.	42.	48.

**ARCHITECTURAL REQUIREMENTS**

<b>WALL AND CEILING</b> Wall Material: <input type="text" value="ARGB 1.2m AFF, GB above"/> Finish: <input type="text" value="PT"/> Ceiling Material: <input type="text" value="ACT"/> Finish: <input type="text" value="PF"/>		<b>WALL PROTECTION</b> Type: <input type="text" value="PVW"/> <input checked="" type="checkbox"/> Corner Guards <input type="checkbox"/> Hand Rails <input type="checkbox"/> Bed Bumper / Locator Height: <input type="text" value="2185 mm"/> <input type="checkbox"/> Crash Rails <input type="checkbox"/> Chair Rail		<b>GLAZING</b> <input type="checkbox"/> Interior Glazing		<b>FLOORING TYPES</b> Material: <input type="text" value="VSF"/> Base: <input type="text" value="FCB"/>		<b>ROOM ACCESSORIES</b> <input type="checkbox"/> Coat Hooks <input type="checkbox"/> Ceiling Lift <input type="checkbox"/> Magnetic Whiteboard <input type="checkbox"/> Mirror <input type="checkbox"/> Infant Change Table <input type="checkbox"/> Privacy Curtain	
--	--	---	--	---	--	--	--	--	--

- LEGEND:**
- WALL AND CEILING LEGEND:**
- AC Architectural Ceiling
  - ACT Acoustic Ceiling Tile
  - ACT-C Cleanroom
  - ARGB Abuse-Resistant Gypsum Board
  - GB Gypsum Board
  - IRGB Impact-Resistant Gypsum Board
  - KLCT Kitchen Lay-in Ceiling Tile
  - MMRGB Moisture and Mould-Resistant Gypsum Board
  - SACT Security Acoustic Ceiling Tile
- WALL FINISHES LEGEND:**
- EWC Epoxy Wall Coating
  - HPC High Performance Coating
  - PT Paint
- CEILING FINISHES LEGEND:**
- ECC Epoxy Ceiling Coating
  - HPC High Performance Coating
  - PF Prefinished
  - PT Paint
- WALL PROTECTION LEGEND:**
- ESRP Extruded Semi-Rigid PVCu Panel
  - FRL Fibre Reinforced Laminate
  - FRP Fibreglass Reinforced Plastic
  - PVW Protective Vinyl Wallcovering
  - RHIS Rigid High Impact Sheet
  - WSSP Wetwall Solid Surface Panel
  - WVV Wetroom Vinyl Wallcovering
- FLOOR FINISHES LEGEND:**
- CFS Concrete Floor Sealer
  - EFC Epoxy Floor Coating
  - PFC Polyurethane Floor Coating
  - RAF Rubber Athletic Flooring
  - RSF Rubber Sheet Flooring
  - SCF Seamless Cushioned Flooring
  - SDRF Static-Dissipative Rubber Sheet Flooring
  - SDVF Static-Dissipative Vinyl Sheet Flooring
  - VSF Vinyl Sheet Flooring
  - WSVF Wetroom Safety Vinyl Sheet Flooring
- FLOOR BASE LEGEND:**
- FCB Flash Cove Base
  - RB Rubber Base
  - SCF Seamless Cushioned Flooring

**DOORS**

Types:

Type	Qty	Size (mm)	Material	Finish	Side Lt	Blinds	Protect	Privacy Film	Function	Card Reader	Mag Lock	Auto Opener	Hold Open	Hinges	Accessory 1	Accessory 2	Accessory 3	Closer

Door Remarks:  Security Grille  Anti-barricade strategy

**MILLWORK AND SPECIALTY CASEWORK**

Storage Requirements:

**UPPER UNITS** U1 U2 U3 U4 U5 U6 U7 U8

**LOWER UNITS** L10 L11 L12

**RECEPTION/TRANSACTION COUNTER / CARE TEAM STATION DESK** TC1 TC2

**UTILITY SINK AND COUNTER UNIT** UC1

**FULL-HEIGHT CABINETS** C1 C2 C3 C4 C5

**Legend:**

Category	Min. Length (mm)	Motorized Adjustable Height	Standing Height	Specialty Casework
Category 0 - None				
Category 1 - Low (1% - 4%)				
Category 2 - Med (5% - 9%)				
Category 3 - High (10% or Greater)				

Remarks:

**FINISHES**

Full-height Cabinet:

Upper Millwork:

Countertop:

Lower Millwork:

Shelf:

**MECHANICAL REQUIREMENTS**

<b>PLUMBING</b> (Quantity) Hygiene Sink: <input type="text"/> Lavatory: <input type="text"/> Kitchen Sink: <input type="text"/> Kitchen Sink: <input type="text"/> Utility / Process Sink: <input type="text"/> Scrub Sink: <input type="text"/> Floor Sink: <input type="text"/>							Other Fixtures: <input type="checkbox"/> Shower <input type="checkbox"/> Eyewash Station <input type="checkbox"/> Tub <input type="checkbox"/> Eyewash/Shower Station <input type="checkbox"/> Ice Maker <input type="checkbox"/> Emergency Shower <input type="checkbox"/> Water Closet <input type="checkbox"/> Flush Rim Sink <input type="checkbox"/> Instantaneous Hot Water <input type="checkbox"/> Floor Drain <input type="checkbox"/> Water Bottle Refill Station Other <input type="text"/>				<b>MED / NON-MED GASES</b> (Quantity) Oxygen: <input type="text"/> Medical Air: <input type="text"/> Medical Vacuum: <input type="text"/> Nitrous Oxide: <input type="text"/> CO2: <input type="text"/> AGSS: <input type="text"/> Nitrogen: <input type="text"/> Laboratory Air: <input type="text"/> Laboratory Vacuum: <input type="text"/> Utility Compressed Air: <input type="text"/>				
Plumbing Remarks: <input type="text"/>							Gas Remarks: <input type="text"/>								

# Appendix 1B Minimum Room Requirements

Room Name:

Program Number(s):

1.	12.01	7.	13.	19.	25.	31.	37.	43.
2.		8.	14.	20.	26.	32.	38.	44.
3.		9.	15.	21.	27.	33.	39.	45.
4.		10.	16.	22.	28.	34.	40.	46.
5.		11.	17.	23.	29.	35.	41.	47.
6.		12.	18.	24.	30.	36.	42.	48.

## ARCHITECTURAL REQUIREMENTS

<b>WALL AND CEILING</b> Wall Material: <input type="text" value="ARGB 1.2m AFF, GB above"/> Finish: <input type="text" value="PT"/> Ceiling Material: <input type="text" value="ACT"/> Finish: <input type="text" value="PF"/>		<b>WALL PROTECTION</b> Type: <input type="text" value="ESRP"/> <input checked="" type="checkbox"/> Corner Guards <input type="checkbox"/> Hand Rails <input type="checkbox"/> Bed Bumper / Locator Height: <input type="text" value="1350 mm"/> <input type="checkbox"/> Crash Rails <input checked="" type="checkbox"/> Chair Rail			<b>GLAZING</b> <input type="checkbox"/> Interior Glazing		<b>FLOORING TYPES</b> Material: <input type="text" value="VSF"/> Base: <input type="text" value="FCB"/>		<b>ROOM ACCESSORIES</b> <input checked="" type="checkbox"/> Coat Hooks <input type="checkbox"/> Ceiling Lift <input checked="" type="checkbox"/> Magnetic Whiteboard <input type="checkbox"/> Mirror <input type="checkbox"/> Infant Change Table <input type="checkbox"/> Privacy Curtain		
--	--	---	--	--	---	--	--	--	--	--	--

- LEGEND:**
- WALL AND CEILING LEGEND:**
- AC Architectural Ceiling
  - ACT Acoustic Ceiling Tile
  - ACT-C Cleanroom
  - ARGB Abuse-Resistant Gypsum Board
  - GB Gypsum Board
  - IRGB Impact-Resistant Gypsum Board
  - KLCT Kitchen Lay-in Ceiling Tile
  - MMRGB Moisture and Mould-Resistant Gypsum Board
  - SACT Security Acoustic Ceiling Tile
- WALL FINISHES LEGEND:**
- EWC Epoxy Wall Coating
  - HPC High Performance Coating
  - PT Paint
- CEILING FINISHES LEGEND:**
- ECC Epoxy Ceiling Coating
  - HPC High Performance Coating
  - PF Prefinished
  - PT Paint
- WALL PROTECTION LEGEND:**
- ESRP Extruded Semi-Rigid PVCu Panel
  - FRL Fibre Reinforced Laminate
  - FRP Fibreglass Reinforced Plastic
  - PVV Protective Vinyl Wallcovering
  - RHIS Rigid High Impact Sheet
  - WSSP Wetwall Solid Surface Panel
  - WVV Wetroom Vinyl Wallcovering
- FLOOR FINISHES LEGEND:**
- CFS Concrete Floor Sealer
  - EFC Epoxy Floor Coating
  - PFC Polyurethane Floor Coating
  - RAF Rubber Athletic Flooring
  - RSF Rubber Sheet Flooring
  - SCF Seamless Cushioned Flooring
  - SDRF Static-Dissipative Rubber Sheet Flooring
  - SDVF Static-Dissipative Vinyl Sheet Flooring
  - VSF Vinyl Sheet Flooring
  - WSVF Wetroom Safety Vinyl Sheet Flooring
- FLOOR BASE LEGEND:**
- FCB Flash Cove Base
  - RB Rubber Base
  - SCF Seamless Cushioned Flooring

**DOORS**

Types:

Type	Qty	Size (mm)	Material	Finish	Side Lt.	Blinds	Protect.	Privacy Film	Function	Card Reader	Mag Lock	Auto Opener	Hold Open	Hinges	Accessory 1	Accessory 2	Accessory 3	Closer
B	1	1065 x 2135	Solid Core	FRL	<input type="checkbox"/>	<input type="checkbox"/>	2 High	<input checked="" type="checkbox"/>	Storeroom	<input checked="" type="checkbox"/>	<input type="checkbox"/>	<input type="checkbox"/>	<input type="checkbox"/>	Butt Hinge				Surface

Door Remarks:  Security Grille  Anti-barricade strategy

**MILLWORK AND SPECIALTY CASEWORK**

**UPPER UNITS** (U1-U8) **LOWER UNITS** (L1-L9)

**RECEPTION/TRANSACTION COUNTER / CARE TEAM STATION DESK** (TC1, TC2)

**UTILITY SINK AND COUNTER UNIT** (UC1)

**Storage Requirements:**  SHELF (S1)

**FINISHES**

Full-height Cabinet:	<input type="text" value="Stainless Steel"/>
Upper Millwork:	<input type="text" value="Stainless Steel"/>
Countertop:	<input type="text" value="Stainless Steel"/>
Lower Millwork:	<input type="text" value="Stainless Steel"/>
Shelf:	<input type="text"/>

Remarks:

**Legend:**

Category	Min. Length (mm)	Motorized Adjustable Height	Standing Height	Specialty Casework
2	3900	<input checked="" type="checkbox"/>	<input checked="" type="checkbox"/>	<input type="checkbox"/>

## MECHANICAL REQUIREMENTS

**PLUMBING** (Quantity)

Hand Hygiene Sink:	1	Lavatory:		Kitchen Sink:		Seamless Kitchen Sink:		Utility / Process Sink:		Scrub Sink:		Floor Sink:	
--------------------	---	-----------	--	---------------	--	------------------------	--	-------------------------	--	-------------	--	-------------	--

Plumbing Remarks:

**Other Fixtures:**

- Shower
- Tub
- Ice Maker
- Water Closet
- Instantaneous Hot Water
- Ewewash Station
- Eyewash/Shower Station
- Emergency Shower
- Flush Rim Sink
- Floor Drain
- Water Bottle Refill Station

Other:

**MED / NON-MED GASES** (Quantity)

Oxygen:	Medical Air:	Medical Vacuum:	Nitrous Oxide:	CO2:	AGSS:	Nitrogen:	Laboratory Air:	Laboratory Vacuum:	Utility Compressed Air:
<input type="text"/>	<input type="text"/>	<input type="text"/>	<input type="text"/>	<input type="text"/>	<input type="text"/>	<input type="text"/>	<input type="text"/>	<input type="text"/>	<input type="text"/>

Gas Remarks:



---

# New Surrey Hospital & BC Cancer Centre

MINIMUM ROOM REQUIREMENTS

**J. Oncology Pharmacy**

---

**Appendix 1B Minimum Room Requirements**

Room Name:

Program Number(s):

1. J4.02	7.	13.	19.	25.	31.	37.	43.
2.	8.	14.	20.	26.	32.	38.	44.
3.	9.	15.	21.	27.	33.	39.	45.
4.	10.	16.	22.	28.	34.	40.	46.
5.	11.	17.	23.	29.	35.	41.	47.
6.	12.	18.	24.	30.	36.	42.	48.

**ARCHITECTURAL REQUIREMENTS**

<b>WALL AND CEILING</b> Wall Material: <input type="text" value="ARGB 1.2m AFF, GB above"/> Finish: <input type="text" value="EWC"/> Ceiling Material: <input type="text" value="ACT"/> Finish: <input type="text" value="ECC"/>	<b>WALL PROTECTION</b> Type: <input type="text" value="ESRP"/> <input checked="" type="checkbox"/> Corner Guards <input type="checkbox"/> Hand Rails <input type="checkbox"/> Bed Bumper / Locator Height: <input type="text" value="2185 mm"/> <input type="checkbox"/> Crash Rails <input type="checkbox"/> Chair Rail	<b>GLAZING</b> <input checked="" type="checkbox"/> Interior Glazing	<b>FLOORING TYPES</b> Material: <input type="text" value="VSF"/> Base: <input type="text" value="FCB"/>	<b>ROOM ACCESSORIES</b> <input checked="" type="checkbox"/> Coat Hooks <input type="checkbox"/> Ceiling Lift <input checked="" type="checkbox"/> Magnetic Whiteboard <input type="checkbox"/> Mirror <input type="checkbox"/> Infant Change Table <input type="checkbox"/> Privacy Curtain
--	--	--	--	--

- LEGEND:**
- WALL AND CEILING LEGEND:**
- AC Architectural Ceiling
  - ACT Acoustic Ceiling Tile
  - ACT-C Cleanroom
  - ARGB Abuse-Resistant Gypsum Board
  - GB Gypsum Board
  - IRGB Impact-Resistant Gypsum Board
  - KLCT Kitchen Lay-in Ceiling Tile
  - MMRGB Moisture and Mould-Resistant Gypsum Board
  - SACT Security Acoustic Ceiling Tile
- WALL FINISHES LEGEND:**
- EWC Epoxy Wall Coating
  - HPC High Performance Coating
  - PT Paint
- CEILING FINISHES LEGEND:**
- ECC Epoxy Ceiling Coating
  - HPC High Performance Coating
  - PF Prefinished
  - PT Paint
- WALL PROTECTION LEGEND:**
- ESRP Extruded Semi-Rigid PVCu Panel
  - FRL Fibre Reinforced Laminate
  - FRP Fibreglass Reinforced Plastic
  - PVV Protective Vinyl Wallcovering
  - RHIS Rigid High Impact Sheet
  - WSSP Wetwall Solid Surface Panel
  - WVV Wetroom Vinyl Wallcovering
- FLOOR FINISHES LEGEND:**
- CFS Concrete Floor Sealer
  - EFC Epoxy Floor Coating
  - PFC Polyurethane Floor Coating
  - RAF Rubber Athletic Flooring
  - RSF Rubber Sheet Flooring
  - SCF Seamless Cushioned Flooring
  - SDRF Static-Dissipative Rubber Sheet Flooring
  - SDVF Static-Dissipative Vinyl Sheet Flooring
  - VSF Vinyl Sheet Flooring
  - WSVF Wetroom Safety Vinyl Sheet Flooring
- FLOOR BASE LEGEND:**
- FCB Flash Cove Base
  - RB Rubber Base
  - SCF Seamless Cushioned Flooring

**DOORS**

Types:

Type:Qty:	Size (mm):	Material:	Finish:	Side Lt:	Blinds:	Protect.:	Privacy Film:	Function:	Card Reader:	Mag Lock:	Auto Opener:	Hold Open:	Hinges:	Accessory 1:	Accessory 2:	Accessory 3:	Closer:

Door Remarks:

Security Grille  
 Anti-barricade strategy

**MILLWORK AND SPECIALTY CASEWORK**

Storage Requirements:

**UPPER UNITS** U1 U2 U3 U4 U5 U6 U7 U8

**LOWER UNITS** L10 L11 L12

**RECEPTION/TRANSACTION COUNTER / CARE TEAM STATION DESK** TC1 TC2

**UTILITY SINK AND COUNTER UNIT** UC1

**SHELF** S1

**FULL-HEIGHT CABINETS** C1 C2 C3 C4 C5

**Legend:**

Category	Min. Length (mm)	Motorized Adjustable Height	Standing Height	Specialty Casework
3	2400	<input checked="" type="checkbox"/>	<input checked="" type="checkbox"/>	<input type="checkbox"/>

**FINISHES**

Full-height Cabinet:

Upper Millwork:

Countertop:

Lower Millwork:

Shelf:

Remarks:

**MECHANICAL REQUIREMENTS**

**PLUMBING**

Hand Hygiene Sink:	Lavatory:	Kitchen Sink:	Seamless Kitchen Sink:	Utility / Process Sink:	Scrub Sink:	Floor Sink:
1						

Plumbing Remarks:

**Other Fixtures:**

- Shower
- Tub
- Ice Maker
- Water Closet
- Instantaneous Hot Water
- Ewewash Station
- Eyewash/Shower Station
- Emergency Shower
- Flush Rim Sink
- Floor Drain
- Water Bottle Refill Station

Other:

**MED / NON-MED GASES**

Oxygen:	Medical Air:	Medical Vacuum:	Nitrous Oxide:	CO2:	AGSS:	Nitrogen:	Laboratory Air:	Laboratory Vacuum:	Utility Compressed Air:

Gas Remarks:

# Appendix 1B Minimum Room Requirements

Room Name:

Program Number(s):

1. J2.01	7.	13.	19.	25.	31.	37.	43.
2.	8.	14.	20.	26.	32.	38.	44.
3.	9.	15.	21.	27.	33.	39.	45.
4.	10.	16.	22.	28.	34.	40.	46.
5.	11.	17.	23.	29.	35.	41.	47.
6.	12.	18.	24.	30.	36.	42.	48.

## ARCHITECTURAL REQUIREMENTS

<b>WALL AND CEILING</b> Wall Material: <input type="text" value="ARGB 1.2m AFF, GB above"/> Finish: <input type="text" value="EWC"/> Ceiling Material: <input type="text" value="ACT-C"/> Finish: <input type="text" value="PF"/>	<b>WALL PROTECTION</b> Type: <input type="text" value="PVW"/> <input checked="" type="checkbox"/> Corner Guards <input type="checkbox"/> Hand Rails <input type="checkbox"/> Bed Bumper / Locator Height: <input type="text" value="2185 mm"/> <input type="checkbox"/> Crash Rails <input type="checkbox"/> Chair Rail	<b>GLAZING</b> <input type="checkbox"/> Interior Glazing	<b>FLOORING TYPES</b> Material: <input type="text" value="VSF"/> Base: <input type="text" value="FCB"/>	<b>ROOM ACCESSORIES</b> <input checked="" type="checkbox"/> Coat Hooks <input type="checkbox"/> Ceiling Lift <input type="checkbox"/> Magnetic Whiteboard <input checked="" type="checkbox"/> Mirror <input type="checkbox"/> Infant Change Table <input type="checkbox"/> Privacy Curtain
---	---	---	--	--

- LEGEND:**
- WALL AND CEILING LEGEND:**
- AC Architectural Ceiling
  - ACT Acoustic Ceiling Tile
  - ACT-C Cleanroom
  - ARGB Abuse-Resistant Gypsum Board
  - GB Gypsum Board
  - IRGB Impact-Resistant Gypsum Board
  - KLCT Kitchen Lay-in Ceiling Tile
  - MMRGB Moisture and Mould-Resistant Gypsum Board
  - SACT Security Acoustic Ceiling Tile
- WALL FINISHES LEGEND:**
- EWC Epoxy Wall Coating
  - HPC High Performance Coating
  - PT Paint
- CEILING FINISHES LEGEND:**
- ECC Epoxy Ceiling Coating
  - HPC High Performance Coating
  - PF Prefinished
  - PT Paint
- WALL PROTECTION LEGEND:**
- ESRP Extruded Semi-Rigid PVCu Panel
  - FRL Fibre Reinforced Laminate
  - FRP Fibreglass Reinforced Plastic
  - PVW Protective Vinyl Wallcovering
  - RHIS Rigid High Impact Sheet
  - WSSP Wetwall Solid Surface Panel
  - WVV Wetroom Vinyl Wallcovering
- FLOOR FINISHES LEGEND:**
- CFS Concrete Floor Sealer
  - EFC Epoxy Floor Coating
  - PFC Polyurethane Floor Coating
  - RAF Rubber Athletic Flooring
  - RSF Rubber Sheet Flooring
  - SCF Seamless Cushioned Flooring
  - SDRF Static-Dissipative Rubber Sheet Flooring
  - SDVF Static-Dissipative Vinyl Sheet Flooring
  - VSF Vinyl Sheet Flooring
  - WSVF Wetroom Safety Vinyl Sheet Flooring
- FLOOR BASE LEGEND:**
- FCB Flash Cove Base
  - RB Rubber Base
  - SCF Seamless Cushioned Flooring

**DOORS**

Types:

Note: for Type F doors, the door panels will be approximately 465/1065 unless otherwise required by the Authority

Door Remarks:  Security Grille  Anti-barricade strategy

Provide handsfree opener on door. Refer to Appendix 10 for door interlocking requirements

Type	Qty	Size (mm)	Material	Finish	Side Lt	Blinds	Protect	Privacy Film	Function	Card Reader	Mag Lock	Auto Opener	Hold Open	Hinges	Accessory 1	Accessory 2	Accessory 3	Closer
F2	2	1530 x 2135	Solid Core	FRL	<input type="checkbox"/>	<input type="checkbox"/>	2 High	<input checked="" type="checkbox"/>	Push/Pull	<input type="checkbox"/>	<input checked="" type="checkbox"/>	<input type="checkbox"/>	<input checked="" type="checkbox"/>	Butt Hinge	Astragal	Flush Bolt		Concealed

**MILLWORK AND SPECIALTY CASEWORK**

Storage Requirements:

**UPPER UNITS** (U1-U8) **SHELF** (S1)

**LOWER UNITS** (L1-L12) **RECEPTION/TRANSACTION COUNTER / CARE TEAM STATION DESK** (TC1-TC2) **UTILITY SINK AND COUNTER UNIT** (UC1)

**FULL-HEIGHT CABINETS** (C1-C5)

**FINISHES**

Full-height Cabinet:   
 Upper Millwork:   
 Countertop:   
 Lower Millwork:   
 Shelf:

Remarks:

Category	Min. Length (mm)	Motorized Adjustable Height	Standing Height	Specialty Casework
2	600	<input type="checkbox"/>	<input type="checkbox"/>	<input type="checkbox"/>

**Legend:**  
 Category 0 - None  
 Category 1 - Low (1% - 4%)  
 Category 2 - Med (5% - 9%)  
 Category 3 - High (10% or Greater)

## MECHANICAL REQUIREMENTS

**PLUMBING** (Quantity)

Hand Hygiene Sink:	Lavatory:	Kitchen Sink:	Seamless Kitchen Sink:	Utility / Process Sink:	Scrub Sink:	Floor Sink:
1						

Plumbing Remarks:

**Other Fixtures:**

- Shower
- Tub
- Ice Maker
- Water Closet
- Instantaneous Hot Water
- Eyewash Station
- Eyewash/Shower Station
- Emergency Shower
- Flush Rim Sink
- Floor Drain
- Water Bottle Refill Station

Other:

**MED / NON-MED GASES** (Quantity)

Oxygen:	Medical Air:	Medical Vacuum:	Nitrous Oxide:	CO2:	AGSS:	Nitrogen:	Laboratory Air:	Laboratory Vacuum:	Utility Compressed Air:

Gas Remarks:



**Appendix 1B Minimum Room Requirements**

Room Name:

Program Number(s):

1. J2.04	7.	13.	19.	25.	31.	37.	43.
2.	8.	14.	20.	26.	32.	38.	44.
3.	9.	15.	21.	27.	33.	39.	45.
4.	10.	16.	22.	28.	34.	40.	46.
5.	11.	17.	23.	29.	35.	41.	47.
6.	12.	18.	24.	30.	36.	42.	48.

**ARCHITECTURAL REQUIREMENTS**

<b>WALL AND CEILING</b> Wall Material: <input type="text" value="ARGB 1.2m AFF, GB above"/> Finish: <input type="text" value="EWC"/> Ceiling Material: <input type="text" value="GB"/> Finish: <input type="text" value="ECC"/>	<b>WALL PROTECTION</b> Type: <input type="text" value="ESRP"/> <input checked="" type="checkbox"/> Corner Guards <input type="checkbox"/> Hand Rails <input type="checkbox"/> Bed Bumper / Locator Height: <input type="text" value="2185 mm"/> <input type="checkbox"/> Crash Rails <input type="checkbox"/> Chair Rail	<b>GLAZING</b> <input type="checkbox"/> Interior Glazing	<b>FLOORING TYPES</b> Material: <input type="text" value="VSF"/> Base: <input type="text" value="FCB"/>	<b>ROOM ACCESSORIES</b> <input checked="" type="checkbox"/> Coat Hooks <input type="checkbox"/> Ceiling Lift <input type="checkbox"/> Magnetic Whiteboard <input checked="" type="checkbox"/> Mirror <input type="checkbox"/> Infant Change Table <input type="checkbox"/> Privacy Curtain
---	--	---	--	--

- LEGEND:**
- WALL AND CEILING LEGEND:**
- AC Architectural Ceiling
  - ACT Acoustic Ceiling Tile
  - ACT-C Cleanroom
  - ARGB Abuse-Resistant Gypsum Board
  - GB Gypsum Board
  - IRGB Impact-Resistant Gypsum Board
  - KLCT Kitchen Lay-in Ceiling Tile
  - MMRGB Moisture and Mould-Resistant Gypsum Board
  - SACT Security Acoustic Ceiling Tile
- WALL FINISHES LEGEND:**
- EWC Epoxy Wall Coating
  - HPC High Performance Coating
  - PT Paint
- CEILING FINISHES LEGEND:**
- ECC Epoxy Ceiling Coating
  - HPC High Performance Coating
  - PF Prefinished
  - PT Paint
- WALL PROTECTION LEGEND:**
- ESRP Extruded Semi-Rigid PVCu Panel
  - FRL Fibre Reinforced Laminate
  - FRP Fibreglass Reinforced Plastic
  - PVV Protective Vinyl Wallcovering
  - RHIS Rigid High Impact Sheet
  - WSSP Wetwall Solid Surface Panel
  - WVV Wetroom Vinyl Wallcovering
- FLOOR FINISHES LEGEND:**
- CFS Concrete Floor Sealer
  - EFC Epoxy Floor Coating
  - PFC Polyurethane Floor Coating
  - RAF Rubber Athletic Flooring
  - RSF Rubber Sheet Flooring
  - SCF Seamless Cushioned Flooring
  - SDRF Static-Dissipative Rubber Sheet Flooring
  - SDVF Static-Dissipative Vinyl Sheet Flooring
  - VSF Vinyl Sheet Flooring
  - WSVF Wetroom Safety Vinyl Sheet Flooring
- FLOOR BASE LEGEND:**
- FCB Flash Cove Base
  - RB Rubber Base
  - SCF Seamless Cushioned Flooring

**DOORS**

Types:

Type	Qty	Size (mm)	Material	Finish	Side Lt.	Blinds	Protect.	Privacy Film	Function	Card Reader	Mag Lock	Auto Opener	Hold Open	Hinges	Accessory 1	Accessory 2	Accessory 3	Closer
B	1	1220 x 2135	Solid Core	FRL	<input type="checkbox"/>	<input type="checkbox"/>	2 High	<input checked="" type="checkbox"/>	Passage	<input type="checkbox"/>	<input checked="" type="checkbox"/>	<input checked="" type="checkbox"/>	<input checked="" type="checkbox"/>	Butt Hinge	Elec. Strike			Concealed

Door Remarks: Refer to Appendix 10 for door interlocking requirements.

Security Grille  
 Anti-barricade strategy

**MILLWORK AND SPECIALTY CASEWORK**

**UPPER UNITS** (U1-U8) **LOWER UNITS** (L1-L12) **RECEPTION/TRANSACTION COUNTER / CARE TEAM STATION DESK** (TC1-TC2) **UTILITY SINK AND COUNTER UNIT** (UC1)

Storage Requirements:

**FINISHES**

Full-height Cabinet:   
 Upper Millwork:   
 Countertop:   
 Lower Millwork:   
 Shelf:

Remarks: Provide ceiling hatches with gaskets.

Category	Min. Length (mm)	Motorized Adjustable Height	Standing Height	Specialty Casework
2	1200	<input type="checkbox"/>	<input type="checkbox"/>	<input type="checkbox"/>

**Legend:**  
 Category 0 - None  
 Category 1 - Low (1% - 4%)  
 Category 2 - Med (5% - 9%)  
 Category 3 - High (10% or Greater)

**MECHANICAL REQUIREMENTS**

<b>PLUMBING</b> (Quantity) Hand Hygiene Sink: <input type="text"/> Lavatory: <input type="text"/> Kitchen Sink: <input type="text"/> Kitchen Sink: <input type="text"/> Utility / Process Sink: <input type="text"/> Scrub Sink: <input type="text" value="1"/> Floor Sink: <input type="text"/> Plumbing Remarks: <input type="text"/>	Other Fixtures: <input type="checkbox"/> Shower <input type="checkbox"/> Eyewash Station <input type="checkbox"/> Tub <input type="checkbox"/> Eyewash/Shower Station <input type="checkbox"/> Ice Maker <input type="checkbox"/> Emergency Shower <input type="checkbox"/> Water Closet <input type="checkbox"/> Flush Rim Sink <input type="checkbox"/> Instantaneous Hot Water <input type="checkbox"/> Floor Drain <input type="checkbox"/> <input type="checkbox"/> Water Bottle Refill Station Other: <input type="text"/>	<b>MED / NON-MED GASES</b> (Quantity) Oxygen: <input type="text"/> Medical Air: <input type="text"/> Medical Vacuum: <input type="text"/> Nitrous Oxide: <input type="text"/> CO2: <input type="text"/> AGSS: <input type="text"/> Nitrogen: <input type="text"/> Laboratory Air: <input type="text"/> Laboratory Vacuum: <input type="text"/> Utility Compressed Air: <input type="text"/> Gas Remarks: <input type="text"/>
--	---	---

**Appendix 1B Minimum Room Requirements**

Room Name:

Program Number(s):

1. J2.05	7.	13.	19.	25.	31.	37.	43.
2.	8.	14.	20.	26.	32.	38.	44.
3.	9.	15.	21.	27.	33.	39.	45.
4.	10.	16.	22.	28.	34.	40.	46.
5.	11.	17.	23.	29.	35.	41.	47.
6.	12.	18.	24.	30.	36.	42.	48.

**ARCHITECTURAL REQUIREMENTS**

<b>WALL AND CEILING</b> Wall Material: <input type="text" value="ARGB 1.2m AFF, GB above"/> Finish: <input type="text" value="EWC"/> Ceiling Material: <input type="text" value="GB"/> Finish: <input type="text" value="ECC"/>	<b>WALL PROTECTION</b> Type: <input type="text" value="ESRP"/> <input checked="" type="checkbox"/> Corner Guards <input type="checkbox"/> Hand Rails <input type="checkbox"/> Bed Bumper / Locator Height: <input type="text" value="2185 mm"/> <input type="checkbox"/> Crash Rails <input type="checkbox"/> Chair Rail	<b>GLAZING</b> <input type="checkbox"/> Interior Glazing	<b>FLOORING TYPES</b> Material: <input type="text" value="VSF"/> Base: <input type="text" value="FCB"/>	<b>ROOM ACCESSORIES</b> <input checked="" type="checkbox"/> Coat Hooks <input type="checkbox"/> Ceiling Lift <input type="checkbox"/> Magnetic Whiteboard <input type="checkbox"/> Mirror <input type="checkbox"/> Infant Change Table <input type="checkbox"/> Privacy Curtain
---	--	---	--	---

- LEGEND:**
- WALL AND CEILING LEGEND:**
- AC Architectural Ceiling
  - ACT Acoustic Ceiling Tile
  - ACT-C Cleanroom
  - ARGB Abuse-Resistant Gypsum Board
  - GB Gypsum Board
  - IRGB Impact-Resistant Gypsum Board
  - KLCT Kitchen Lay-in Ceiling Tile
  - MMRGB Moisture and Mould-Resistant Gypsum Board
  - SACT Security Acoustic Ceiling Tile
- WALL FINISHES LEGEND:**
- EWC Epoxy Wall Coating
  - HPC High Performance Coating
  - PT Paint
- CEILING FINISHES LEGEND:**
- ECC Epoxy Ceiling Coating
  - HPC High Performance Coating
  - PF Prefinished
  - PT Paint
- WALL PROTECTION LEGEND:**
- ESRP Extruded Semi-Rigid PVCu Panel
  - FRL Fibre Reinforced Laminate
  - FRP Fibreglass Reinforced Plastic
  - PVV Protective Vinyl Wallcovering
  - RHIS Rigid High Impact Sheet
  - WSSP Wetwall Solid Surface Panel
  - WVV Wetroom Vinyl Wallcovering
- FLOOR FINISHES LEGEND:**
- CFS Concrete Floor Sealer
  - EFC Epoxy Floor Coating
  - PFC Polyurethane Floor Coating
  - RAF Rubber Athletic Flooring
  - RSF Rubber Sheet Flooring
  - SCF Seamless Cushioned Flooring
  - SDRF Static-Dissipative Rubber Sheet Flooring
  - SDVF Static-Dissipative Vinyl Sheet Flooring
  - VSF Vinyl Sheet Flooring
  - WSVF Wetroom Safety Vinyl Sheet Flooring
- FLOOR BASE LEGEND:**
- FCB Flash Cove Base
  - RB Rubber Base
  - SCF Seamless Cushioned Flooring

**DOORS**

Types:

Type	Qty	Size (mm)	Material	Finish	Side Lt.	Blinds	Protect.	Privacy Film	Function	Card Reader	Mag Lock	Auto Opener	Hold Open	Hinges	Accessory 1	Accessory 2	Accessory 3	Closer
B	1	1220 x 2135	Solid Core	FRL	<input type="checkbox"/>	<input type="checkbox"/>	2 High	<input checked="" type="checkbox"/>	Push/Pull	<input type="checkbox"/>	<input checked="" type="checkbox"/>	<input type="checkbox"/>	<input checked="" type="checkbox"/>	Butt Hinge				Concealed

Door Remarks: Refer to Appendix 10 for door interlocking requirements.

Security Grille  
 Anti-barricade strategy

**MILLWORK AND SPECIALTY CASEWORK**

**UPPER UNITS** (U1-U8) **SHELF** (S1)

**LOWER UNITS** (L1-L12) **RECEPTION/TRANSACTION COUNTER / CARE TEAM STATION DESK** (TC1, TC2) **UTILITY SINK AND COUNTER UNIT** (UC1)

**FULL-HEIGHT CABINETS** (C1-C5)

Storage Requirements:

**FINISHES**

Full-height Cabinet:   
 Upper Millwork:   
 Countertop:   
 Lower Millwork:   
 Shelf:

Remarks: Provide ceiling hatches with gaskets.

Category	Min. Length (mm)	Motorized Adjustable Height	Standing Height	Specialty Casework
Category 0 - None		<input type="checkbox"/>	<input type="checkbox"/>	<input type="checkbox"/>
Category 1 - Low (1% - 4%)		<input type="checkbox"/>	<input type="checkbox"/>	<input type="checkbox"/>
Category 2 - Med (5% - 9%)		<input type="checkbox"/>	<input type="checkbox"/>	<input type="checkbox"/>
Category 3 - High (10% or Greater)		<input type="checkbox"/>	<input type="checkbox"/>	<input type="checkbox"/>

**MECHANICAL REQUIREMENTS**

<b>PLUMBING</b> (Quantity) Hand Hygiene Sink: <input type="text"/> Lavatory: <input type="text"/> Kitchen Sink: <input type="text"/> Seamless Kitchen Sink: <input type="text"/> Utility / Process Sink: <input type="text"/> Scrub Sink: <input type="text"/> Floor Sink: <input type="text"/> Plumbing Remarks: <input type="text"/>	Other Fixtures: <input type="checkbox"/> Shower <input type="checkbox"/> Eyewash Station <input type="checkbox"/> Tub <input type="checkbox"/> Eyewash/Shower Station <input type="checkbox"/> Ice Maker <input type="checkbox"/> Emergency Shower <input type="checkbox"/> Water Closet <input type="checkbox"/> Flush Rim Sink <input type="checkbox"/> Instantaneous Hot Water <input type="checkbox"/> Floor Drain <input type="checkbox"/> <input type="checkbox"/> Water Bottle Refill Station Other <input type="text"/>	<b>MED / NON-MED GASES</b> (Quantity) Oxygen: <input type="text"/> Medical Air: <input type="text"/> Medical Vacuum: <input type="text"/> Nitrous Oxide: <input type="text"/> CO2: <input type="text"/> AGSS: <input type="text"/> Nitrogen: <input type="text"/> Laboratory Air: <input type="text"/> Laboratory Vacuum: <input type="text"/> Utility Compressed Air: <input type="text"/> Gas Remarks: <input type="text"/>
---	--	--

**Appendix 1B Minimum Room Requirements**

Room Name:

Program Number(s):

1. J4.01.01	7.	13.	19.	25.	31.	37.	43.
2.	8.	14.	20.	26.	32.	38.	44.
3.	9.	15.	21.	27.	33.	39.	45.
4.	10.	16.	22.	28.	34.	40.	46.
5.	11.	17.	23.	29.	35.	41.	47.
6.	12.	18.	24.	30.	36.	42.	48.

**ARCHITECTURAL REQUIREMENTS**

<b>WALL AND CEILING</b> Wall Material: <input type="text" value="MMRGB"/> Finish: <input type="text" value="PT"/> Ceiling Material: <input type="text" value="ACT"/> Finish: <input type="text" value="PF"/>		<b>WALL PROTECTION</b> Type: <input type="text" value="RHIS"/> <input checked="" type="checkbox"/> Corner Guards <input type="checkbox"/> Hand Rails <input type="checkbox"/> Bed Bumper / Locator Height: <input type="text" value="2185 mm"/> <input type="checkbox"/> Crash Rails <input type="checkbox"/> Chair Rail		<b>GLAZING</b> <input checked="" type="checkbox"/> Interior Glazing		<b>FLOORING TYPES</b> Material: <input type="text" value="VSF"/> Base: <input type="text" value="FCB"/>		<b>ROOM ACCESSORIES</b> <input checked="" type="checkbox"/> Coat Hooks <input type="checkbox"/> Ceiling Lift <input checked="" type="checkbox"/> Magnetic Whiteboard <input type="checkbox"/> Mirror <input type="checkbox"/> Infant Change Table <input type="checkbox"/> Privacy Curtain	
--	--	--	--	--	--	--	--	--	--

- LEGEND:**
- WALL AND CEILING LEGEND:**
- AC Architectural Ceiling
  - ACT Acoustic Ceiling Tile
  - ACT-C Cleanroom
  - ARGB Abuse-Resistant Gypsum Board
  - GB Gypsum Board
  - IRGB Impact-Resistant Gypsum Board
  - KLCT Kitchen Lay-in Ceiling Tile
  - MMRGB Moisture and Mould-Resistant Gypsum Board
  - SACT Security Acoustic Ceiling Tile
- WALL FINISHES LEGEND:**
- EWC Epoxy Wall Coating
  - HPC High Performance Coating
  - PT Paint
- CEILING FINISHES LEGEND:**
- ECC Epoxy Ceiling Coating
  - HPC High Performance Coating
  - PF Prefinished
  - PT Paint
- WALL PROTECTION LEGEND:**
- ESRP Extruded Semi-Rigid PVCu Panel
  - FRL Fibre Reinforced Laminate
  - FRP Fibreglass Reinforced Plastic
  - PVV Protective Vinyl Wallcovering
  - RHIS Rigid High Impact Sheet
  - WSSP Wetwall Solid Surface Panel
  - WVV Wetroom Vinyl Wallcovering
- FLOOR FINISHES LEGEND:**
- CFS Concrete Floor Sealer
  - EFC Epoxy Floor Coating
  - PFC Polyurethane Floor Coating
  - RAF Rubber Athletic Flooring
  - RSF Rubber Sheet Flooring
  - SCF Seamless Cushioned Flooring
  - SDRF Static-Dissipative Rubber Sheet Flooring
  - SDVF Static-Dissipative Vinyl Sheet Flooring
  - VSF Vinyl Sheet Flooring
  - WSVF Wetroom Safety Vinyl Sheet Flooring
- FLOOR BASE LEGEND:**
- FCB Flash Cove Base
  - RB Rubber Base
  - SCF Seamless Cushioned Flooring

**DOORS**

Types:

Type:Qty:	Size (mm):	Material:	Finish:	Side Lt:	Blinds:	Protect.:	Privacy Film:	Function:	Card Reader:	Mag Lock:	Auto Opener:	Hold Open:	Hinges:	Accessory 1:	Accessory 2:	Accessory 3:	Closer:

Door Remarks:  Security Grille  Anti-barricade strategy

**MILLWORK AND SPECIALTY CASEWORK**

Storage Requirements:

**UPPER UNITS** (U1-U8) **SHELF** (S1)

**LOWER UNITS** (L1-L12) **RECEPTION/TRANSACTION COUNTER / CARE TEAM STATION DESK** (TC1, TC2) **UTILITY SINK AND COUNTER UNIT** (UC1)

**FULL-HEIGHT CABINETS** (C1-C5)

**Legend:**

Category	Min. Length (mm)	Motorized Adjustable Height	Standing Height	Specialty Casework
Category 0 - None				
Category 1 - Low (1% - 4%)				
Category 2 - Med (5% - 9%)				
Category 3 - High (10% or Greater)				

**FINISHES**

Full-height Cabinet:   
 Upper Millwork:   
 Countertop:   
 Lower Millwork:   
 Shelf:

Remarks:

**MECHANICAL REQUIREMENTS**

<b>PLUMBING</b> (Quantity) Hygiene Sink: <input type="text"/> Lavatory: <input type="text"/> Kitchen Sink: <input type="text"/> Kitchen Sink: <input type="text"/> Utility / Process Sink: <input type="text"/> Scrub Sink: <input type="text"/> Floor Sink: <input type="text"/> Plumbing Remarks: <input type="text"/>							Other Fixtures: <input type="checkbox"/> Shower <input type="checkbox"/> Eyewash Station <input type="checkbox"/> Tub <input type="checkbox"/> Eyewash/Shower Station <input type="checkbox"/> Ice Maker <input type="checkbox"/> Emergency Shower <input type="checkbox"/> Water Closet <input type="checkbox"/> Flush Rim Sink <input type="checkbox"/> Instantaneous Hot Water <input type="checkbox"/> Floor Drain <input type="checkbox"/> Water Bottle Refill Station Other <input type="text"/>				<b>MED / NON-MED GASES</b> (Quantity) Oxygen: <input type="text"/> Medical Air: <input type="text"/> Medical Vacuum: <input type="text"/> Nitrous Oxide: <input type="text"/> CO2: <input type="text"/> AGSS: <input type="text"/> Nitrogen: <input type="text"/> Laboratory Air: <input type="text"/> Laboratory Vacuum: <input type="text"/> Utility Compressed Air: <input type="text"/> Gas Remarks: <input type="text"/>					
--	--	--	--	--	--	--	---	--	--	--	---	--	--	--	--	--



**Appendix 1B Minimum Room Requirements**

Room Name:

Program Number(s):

1. J3.02	7.	13.	19.	25.	31.	37.	43.
2.	8.	14.	20.	26.	32.	38.	44.
3.	9.	15.	21.	27.	33.	39.	45.
4.	10.	16.	22.	28.	34.	40.	46.
5.	11.	17.	23.	29.	35.	41.	47.
6.	12.	18.	24.	30.	36.	42.	48.

**ARCHITECTURAL REQUIREMENTS**

<b>WALL AND CEILING</b> Wall Material: <input type="text" value="ARGB 1.2m AFF, GB above"/> Finish: <input type="text" value="EWC"/> Ceiling Material: <input type="text" value="ACT"/> Finish: <input type="text" value="PF"/>	<b>WALL PROTECTION</b> Type: <input type="text" value="ESRP"/> <input type="checkbox"/> Corner Guards <input type="checkbox"/> Hand Rails <input type="checkbox"/> Bed Bumper / Locator Height: <input type="text" value="1350 mm"/> <input type="checkbox"/> Crash Rails <input type="checkbox"/> Chair Rail	<b>GLAZING</b> <input type="checkbox"/> Interior Glazing	<b>FLOORING TYPES</b> Material: <input type="text" value="VSF"/> Base: <input type="text" value="FCB"/>	<b>ROOM ACCESSORIES</b> <input checked="" type="checkbox"/> Coat Hooks <input type="checkbox"/> Ceiling Lift <input checked="" type="checkbox"/> Magnetic Whiteboard <input type="checkbox"/> Mirror <input type="checkbox"/> Infant Change Table <input type="checkbox"/> Privacy Curtain
---	---	---	--	--

- LEGEND:**
- WALL AND CEILING LEGEND:**
- AC Architectural Ceiling
  - ACT Acoustic Ceiling Tile
  - ACT-C Cleanroom
  - ARGB Abuse-Resistant Gypsum Board
  - GB Gypsum Board
  - IRGB Impact-Resistant Gypsum Board
  - KLCT Kitchen Lay-in Ceiling Tile
  - MMRGB Moisture and Mould-Resistant Gypsum Board
  - SACT Security Acoustic Ceiling Tile
- WALL FINISHES LEGEND:**
- EWC Epoxy Wall Coating
  - HPC High Performance Coating
  - PT Paint
- CEILING FINISHES LEGEND:**
- ECC Epoxy Ceiling Coating
  - HPC High Performance Coating
  - PF Prefinished
  - PT Paint
- WALL PROTECTION LEGEND:**
- ESRP Extruded Semi-Rigid PVCu Panel
  - FRL Fibre Reinforced Laminate
  - FRP Fibreglass Reinforced Plastic
  - PVV Protective Vinyl Wallcovering
  - RHIS Rigid High Impact Sheet
  - WSSP Wetwall Solid Surface Panel
  - WVV Wetroom Vinyl Wallcovering
- FLOOR FINISHES LEGEND:**
- CFS Concrete Floor Sealer
  - EFC Epoxy Floor Coating
  - PFC Polyurethane Floor Coating
  - RAF Rubber Athletic Flooring
  - RSF Rubber Sheet Flooring
  - SCF Seamless Cushioned Flooring
  - SDRF Static-Dissipative Rubber Sheet Flooring
  - SDVF Static-Dissipative Vinyl Sheet Flooring
  - VSF Vinyl Sheet Flooring
  - WSVF Wetroom Safety Vinyl Sheet Flooring
- FLOOR BASE LEGEND:**
- FCB Flash Cove Base
  - RB Rubber Base
  - SCF Seamless Cushioned Flooring

**DOORS**

Types:

Type:Qty:	Size (mm):	Material:	Finish:	Side Lt:	Blinds:	Protect.:	Privacy Film:	Function:	Card Reader:	Mag Lock:	Auto Opener:	Hold Open:	Hinges:	Accessory 1:	Accessory 2:	Accessory 3:	Closer:
				<input type="checkbox"/>	<input type="checkbox"/>		<input type="checkbox"/>		<input type="checkbox"/>	<input type="checkbox"/>	<input type="checkbox"/>	<input type="checkbox"/>					

Door Remarks:  Security Grille  Anti-barricade strategy

**MILLWORK AND SPECIALTY CASEWORK**

**UPPER UNITS** (U1-U8) **SHELF** (S1)

**LOWER UNITS** (L1-L12) **RECEPTION/TRANSACTION COUNTER / CARE TEAM STATION DESK** (TC1, TC2) **UTILITY SINK AND COUNTER UNIT** (UC1)

**FULL-HEIGHT CABINETS** (C1-C5)

Storage Requirements:

**FINISHES**

Full-height Cabinet:   
 Upper Millwork:   
 Countertop:   
 Lower Millwork:   
 Shelf:

Remarks: Refer to Schedule 1, Section 6.12 (Division 12) for Specialty Casework. Items indicated are diagrammatic, provide specialty casework appropriate for the specific and specialized functions to be performed in the space and to accommodate Equipment.

Category	Min. Length (mm)	Motorized Adjustable Height	Standing Height	Specialty Casework
3	2400	<input type="checkbox"/>	<input type="checkbox"/>	<input checked="" type="checkbox"/>

**MECHANICAL REQUIREMENTS**

<b>PLUMBING</b> (Quantity) Hand Hygiene Sink: <input type="text"/> Lavatory: <input type="text"/> Kitchen Sink: <input type="text"/> Seamless Kitchen Sink: <input type="text"/> Utility / Process Sink: <input type="text"/> Scrub Sink: <input type="text"/> Floor Sink: <input type="text"/> Plumbing Remarks: <input type="text"/>	Other Fixtures: <input type="checkbox"/> Shower <input type="checkbox"/> Eyewash Station <input type="checkbox"/> Tub <input type="checkbox"/> Eyewash/Shower Station <input type="checkbox"/> Ice Maker <input type="checkbox"/> Emergency Shower <input type="checkbox"/> Water Closet <input type="checkbox"/> Flush Rim Sink <input type="checkbox"/> Instantaneous Hot Water <input type="checkbox"/> Floor Drain <input type="checkbox"/> <input type="checkbox"/> Water Bottle Refill Station Other <input type="text"/>	<b>MED / NON-MED GASES</b> (Quantity) Oxygen: <input type="text"/> Medical Air: <input type="text"/> Medical Vacuum: <input type="text"/> Nitrous Oxide: <input type="text"/> CO2: <input type="text"/> AGSS: <input type="text"/> Nitrogen: <input type="text"/> Laboratory Air: <input type="text"/> Laboratory Vacuum: <input type="text"/> Utility Compressed Air: <input type="text"/> Gas Remarks: <input type="text"/>
---	--	---

**Appendix 1B Minimum Room Requirements**

Room Name:

Program Number(s):

1. J3.01	7.	13.	19.	25.	31.	37.	43.
2.	8.	14.	20.	26.	32.	38.	44.
3.	9.	15.	21.	27.	33.	39.	45.
4.	10.	16.	22.	28.	34.	40.	46.
5.	11.	17.	23.	29.	35.	41.	47.
6.	12.	18.	24.	30.	36.	42.	48.

**ARCHITECTURAL REQUIREMENTS**

<b>WALL AND CEILING</b> Wall Material: <input type="text" value="ARGB 1.2m AFF, GB above"/> Finish: <input type="text" value="EWC"/> Ceiling Material: <input type="text" value="ACT"/> Finish: <input type="text" value="PF"/>	<b>WALL PROTECTION</b> Type: <input type="text" value="ESRP"/> <input checked="" type="checkbox"/> Corner Guards <input type="checkbox"/> Hand Rails <input type="checkbox"/> Bed Bumper / Locator Height: <input type="text" value="2185 mm"/> <input type="checkbox"/> Crash Rails <input type="checkbox"/> Chair Rail	<b>GLAZING</b> <input type="checkbox"/> Interior Glazing	<b>FLOORING TYPES</b> Material: <input type="text" value="VSF"/> Base: <input type="text" value="FCB"/>	<b>ROOM ACCESSORIES</b> <input checked="" type="checkbox"/> Coat Hooks <input type="checkbox"/> Ceiling Lift <input checked="" type="checkbox"/> Magnetic Whiteboard <input type="checkbox"/> Mirror <input type="checkbox"/> Infant Change Table <input type="checkbox"/> Privacy Curtain
---	--	---	--	--

- LEGEND:**
- WALL AND CEILING LEGEND:**
- AC Architectural Ceiling
  - ACT Acoustic Ceiling Tile
  - ACT-C Cleanroom
  - ARGB Abuse-Resistant Gypsum Board
  - GB Gypsum Board
  - IRGB Impact-Resistant Gypsum Board
  - KLCT Kitchen Lay-in Ceiling Tile
  - MMRGB Moisture and Mould-Resistant Gypsum Board
  - SACT Security Acoustic Ceiling Tile
- WALL FINISHES LEGEND:**
- EWC Epoxy Wall Coating
  - HPC High Performance Coating
  - PT Paint
- CEILING FINISHES LEGEND:**
- ECC Epoxy Ceiling Coating
  - HPC High Performance Coating
  - PF Prefinished
  - PT Paint
- WALL PROTECTION LEGEND:**
- ESRP Extruded Semi-Rigid PVCu Panel
  - FRL Fibre Reinforced Laminate
  - FRP Fibreglass Reinforced Plastic
  - PVV Protective Vinyl Wallcovering
  - RHIS Rigid High Impact Sheet
  - WSSP Wetwall Solid Surface Panel
  - WVV Wetroom Vinyl Wallcovering
- FLOOR FINISHES LEGEND:**
- CFS Concrete Floor Sealer
  - EFC Epoxy Floor Coating
  - PFC Polyurethane Floor Coating
  - RAF Rubber Athletic Flooring
  - RSF Rubber Sheet Flooring
  - SCF Seamless Cushioned Flooring
  - SDRF Static-Dissipative Rubber Sheet Flooring
  - SDVF Static-Dissipative Vinyl Sheet Flooring
  - VSF Vinyl Sheet Flooring
  - WSVF Wetroom Safety Vinyl Sheet Flooring
- FLOOR BASE LEGEND:**
- FCB Flash Cove Base
  - RB Rubber Base
  - SCF Seamless Cushioned Flooring

**DOORS**

Types:

Type:Qty:	Size (mm):	Material:	Finish:	Side Lt:	Blinds:	Protect.:	Privacy Film:	Function:	Card Reader:	Mag Lock:	Auto Opener:	Hold Open:	Hinges:	Accessory 1:	Accessory 2:	Accessory 3:	Closer:

Door Remarks:  Security Grille  Anti-barricade strategy

**MILLWORK AND SPECIALTY CASEWORK**

Storage Requirements:

**UPPER UNITS** (U1-U8) **SHELF** (S1)

**FULL-HEIGHT CABINETS** (C1-C5, L1-L9)

**LOWER UNITS** (L10-L12) **RECEPTION/TRANSACTION COUNTER / CARE TEAM STATION DESK** (TC1, TC2) **UTILITY SINK AND COUNTER UNIT** (UC1)

Category	Min. Length (mm)	Motorized Adjustable Height	Standing Height	Specialty Casework
1	900	<input type="checkbox"/>	<input type="checkbox"/>	<input checked="" type="checkbox"/>

**FINISHES**

Full-height Cabinet:   
 Upper Millwork:   
 Countertop:   
 Lower Millwork:   
 Shelf:

Remarks: Refer to Schedule 1, Section 6.12 (Division 12) for Specialty Casework. Items indicated are diagrammatic, provide specialty casework appropriate for the specific and specialized functions to be performed in the space and to accommodate Equipment. Provide work counter with sink and 4 sorting stations (2.8nsm), 6 Pharmacy Review Workstations (2.8nsm) and 3 Pre-packaging workstations (4.6nsm).

**MECHANICAL REQUIREMENTS**

<b>PLUMBING</b> (Quantity) Hand Hygiene Sink: <input type="text" value="1"/> Lavatory: <input type="text"/> Kitchen Sink: <input type="text"/> Seamless Kitchen Sink: <input type="text"/> Utility / Process Sink: <input type="text" value="1"/> Scrub Sink: <input type="text"/> Floor Sink: <input type="text"/> Plumbing Remarks: <input type="text"/>	Other Fixtures: <input type="checkbox"/> Shower <input type="checkbox"/> Eyewash Station <input type="checkbox"/> Tub <input type="checkbox"/> Eyewash/Shower Station <input type="checkbox"/> Ice Maker <input type="checkbox"/> Emergency Shower <input type="checkbox"/> Water Closet <input type="checkbox"/> Flush Rim Sink <input type="checkbox"/> Instantaneous Hot Water <input type="checkbox"/> Floor Drain <input type="checkbox"/> Water Bottle Refill Station Other: <input type="text"/>	<b>MED / NON-MED GASES</b> (Quantity) Oxygen: <input type="text"/> Medical Air: <input type="text"/> Medical Vacuum: <input type="text"/> Nitrous Oxide: <input type="text"/> CO2: <input type="text"/> AGSS: <input type="text"/> Nitrogen: <input type="text"/> Laboratory Air: <input type="text"/> Laboratory Vacuum: <input type="text"/> Utility Compressed Air: <input type="text"/> Gas Remarks: <input type="text"/>
---	--	---

# Appendix 1B Minimum Room Requirements

Room Name:

Program Number(s):

1.	J4.01.02	7.		13.		19.		25.		31.		37.		43.
2.		8.		14.		20.		26.		32.		38.		44.
3.		9.		15.		21.		27.		33.		39.		45.
4.		10.		16.		22.		28.		34.		40.		46.
5.		11.		17.		23.		29.		35.		41.		47.
6.		12.		18.		24.		30.		36.		42.		48.

## ARCHITECTURAL REQUIREMENTS

<b>WALL AND CEILING</b> Wall Material: <input type="text" value="MMRGB"/> Finish: <input type="text" value="PT"/> Ceiling Material: <input type="text" value="ACT"/> Finish: <input type="text" value="PF"/>	<b>WALL PROTECTION</b> Type: <input type="text" value="RHIS"/> <input checked="" type="checkbox"/> Corner Guards <input type="checkbox"/> Hand Rails <input type="checkbox"/> Bed Bumper / Locator Height: <input type="text" value="2185 mm"/> <input checked="" type="checkbox"/> Crash Rails <input type="checkbox"/> Chair Rail	<b>GLAZING</b> <input type="checkbox"/> Interior Glazing	<b>FLOORING TYPES</b> Material: <input type="text" value="VSF"/> Base: <input type="text" value="FCB"/>	<b>ROOM ACCESSORIES</b> <input type="checkbox"/> Coat Hooks <input type="checkbox"/> Ceiling Lift <input type="checkbox"/> Magnetic Whiteboard <input type="checkbox"/> Mirror <input type="checkbox"/> Infant Change Table <input type="checkbox"/> Privacy Curtain
--	---	---	--	--

- LEGEND:**
- WALL AND CEILING LEGEND:**
- AC Architectural Ceiling
  - ACT Acoustic Ceiling Tile
  - ACT-C Cleanroom
  - ARGB Abuse-Resistant Gypsum Board
  - GB Gypsum Board
  - IRGB Impact-Resistant Gypsum Board
  - KLCT Kitchen Lay-in Ceiling Tile
  - MMRGB Moisture and Mould-Resistant Gypsum Board
  - SACT Security Acoustic Ceiling Tile
- WALL FINISHES LEGEND:**
- EWC Epoxy Wall Coating
  - HPC High Performance Coating
  - PT Paint
- CEILING FINISHES LEGEND:**
- ECC Epoxy Ceiling Coating
  - HPC High Performance Coating
  - PF Prefinished
  - PT Paint
- WALL PROTECTION LEGEND:**
- ESRP Extruded Semi-Rigid PVCu Panel
  - FRL Fibre Reinforced Laminate
  - FRP Fibreglass Reinforced Plastic
  - PVV Protective Vinyl Wallcovering
  - RHIS Rigid High Impact Sheet
  - WSSP Wetwall Solid Surface Panel
  - WVV Wetroom Vinyl Wallcovering
- FLOOR FINISHES LEGEND:**
- CFS Concrete Floor Sealer
  - EFC Epoxy Floor Coating
  - PFC Polyurethane Floor Coating
  - RAF Rubber Athletic Flooring
  - RSF Rubber Sheet Flooring
  - SCF Seamless Cushioned Flooring
  - SDRF Static-Dissipative Rubber Sheet Flooring
  - SDVF Static-Dissipative Vinyl Sheet Flooring
  - VSF Vinyl Sheet Flooring
  - WSVF Wetroom Safety Vinyl Sheet Flooring
- FLOOR BASE LEGEND:**
- FCB Flash Cove Base
  - RB Rubber Base
  - SCF Seamless Cushioned Flooring

**DOORS**

Types:

Type:Qty:	Size (mm):	Material:	Finish:	Side Lt:	Blinds:	Protect.:	Privacy Film:	Function:	Card Reader:	Mag Lock:	Auto Opener:	Hold Open:	Hinges:	Accessory 1:	Accessory 2:	Accessory 3:	Closer:

Door Remarks:  Security Grille  Anti-barricade strategy

**MILLWORK AND SPECIALTY CASEWORK**

**UPPER UNITS** (U1-U8) **LOWER UNITS** (L1-L12) **RECEPTION/TRANSACTION COUNTER / CARE TEAM STATION DESK** (TC1-TC2) **UTILITY SINK AND COUNTER UNIT** (UC1)

Storage Requirements:  SHELF (S1)

**FINISHES**

Full-height Cabinet:   
 Upper Millwork:   
 Countertop:   
 Lower Millwork:   
 Shelf:

Remarks:

**Legend:**

Category	Min. Length (mm)	Motorized Adjustable Height	Standing Height	Specialty Casework
Category 0 - None				
Category 1 - Low (1% - 4%)				
Category 2 - Med (5% - 9%)				
Category 3 - High (10% or Greater)				
3	1800	<input type="checkbox"/>	<input type="checkbox"/>	<input type="checkbox"/>

## MECHANICAL REQUIREMENTS

<b>PLUMBING</b> (Quantity) Hand Hygiene Sink: <input type="text" value="1"/> Lavatory: <input type="text"/> Kitchen Sink: <input type="text"/> Seamless Kitchen Sink: <input type="text"/> Utility / Process Sink: <input type="text"/> Scrub Sink: <input type="text"/> Floor Sink: <input type="text"/> Plumbing Remarks: <input type="text"/>	Other Fixtures: <input type="checkbox"/> Shower <input type="checkbox"/> Eyewash Station <input type="checkbox"/> Tub <input type="checkbox"/> Eyewash/Shower Station <input type="checkbox"/> Ice Maker <input type="checkbox"/> Emergency Shower <input type="checkbox"/> Water Closet <input type="checkbox"/> Flush Rim Sink <input type="checkbox"/> Instantaneous Hot Water <input type="checkbox"/> Floor Drain <input type="checkbox"/> Water Bottle Refill Station Other: <input type="text"/>	<b>MED / NON-MED GASES</b> (Quantity) Oxygen: <input type="text"/> Medical Air: <input type="text"/> Medical Vacuum: <input type="text"/> Nitrous Oxide: <input type="text"/> CO2: <input type="text"/> AGSS: <input type="text"/> Nitrogen: <input type="text"/> Laboratory Air: <input type="text"/> Laboratory Vacuum: <input type="text"/> Utility Compressed Air: <input type="text"/> Gas Remarks: <input type="text"/>
---	--	---



**Appendix 1B Minimum Room Requirements**

Room Name:

Program Number(s):

1. J2.06	7.	13.	19.	25.	31.	37.	43.
2.	8.	14.	20.	26.	32.	38.	44.
3.	9.	15.	21.	27.	33.	39.	45.
4.	10.	16.	22.	28.	34.	40.	46.
5.	11.	17.	23.	29.	35.	41.	47.
6.	12.	18.	24.	30.	36.	42.	48.

**ARCHITECTURAL REQUIREMENTS**

<b>WALL AND CEILING</b> Wall Material: <input type="text" value="ARGB 1.2m AFF, GB above"/> Finish: <input type="text" value="EWC"/> Ceiling Material: <input type="text" value="GB"/> Finish: <input type="text" value="ECC"/>	<b>WALL PROTECTION</b> Type: <input type="text" value="ESRP"/> <input checked="" type="checkbox"/> Corner Guards <input type="checkbox"/> Hand Rails <input type="checkbox"/> Bed Bumper / Locator Height: <input type="text" value="2185 mm"/> <input type="checkbox"/> Crash Rails <input type="checkbox"/> Chair Rail	<b>GLAZING</b> <input type="checkbox"/> Interior Glazing	<b>FLOORING TYPES</b> Material: <input type="text" value="VSF"/> Base: <input type="text" value="FCB"/>	<b>ROOM ACCESSORIES</b> <input type="checkbox"/> Coat Hooks <input type="checkbox"/> Ceiling Lift <input checked="" type="checkbox"/> Magnetic Whiteboard <input type="checkbox"/> Mirror <input type="checkbox"/> Infant Change Table <input type="checkbox"/> Privacy Curtain
---	--	---	--	---

- LEGEND:**
- WALL AND CEILING LEGEND:**
- AC Architectural Ceiling
  - ACT Acoustic Ceiling Tile
  - ACT-C Cleanroom
  - ARGB Abuse-Resistant Gypsum Board
  - GB Gypsum Board
  - IRGB Impact-Resistant Gypsum Board
  - KLCT Kitchen Lay-in Ceiling Tile
  - MMRGB Moisture and Mould-Resistant Gypsum Board
  - SACT Security Acoustic Ceiling Tile
- WALL FINISHES LEGEND:**
- EWC Epoxy Wall Coating
  - HPC High Performance Coating
  - PT Paint
- CEILING FINISHES LEGEND:**
- ECC Epoxy Ceiling Coating
  - HPC High Performance Coating
  - PF Prefinished
  - PT Paint
- WALL PROTECTION LEGEND:**
- ESRP Extruded Semi-Rigid PVCu Panel
  - FRL Fibre Reinforced Laminate
  - FRP Fibreglass Reinforced Plastic
  - PVV Protective Vinyl Wallcovering
  - RHIS Rigid High Impact Sheet
  - WSSP Wetwall Solid Surface Panel
  - WVV Wetroom Vinyl Wallcovering
- FLOOR FINISHES LEGEND:**
- CFS Concrete Floor Sealer
  - EFC Epoxy Floor Coating
  - PFC Polyurethane Floor Coating
  - RAF Rubber Athletic Flooring
  - RSF Rubber Sheet Flooring
  - SCF Seamless Cushioned Flooring
  - SDRF Static-Dissipative Rubber Sheet Flooring
  - SDVF Static-Dissipative Vinyl Sheet Flooring
  - VSF Vinyl Sheet Flooring
  - WSVF Wetroom Safety Vinyl Sheet Flooring
- FLOOR BASE LEGEND:**
- FCB Flash Cove Base
  - RB Rubber Base
  - SCF Seamless Cushioned Flooring

**DOORS**

Types:

Type	Qty	Size (mm)	Material	Finish	Side Lt.	Blinds	Protect.	Privacy Film	Function	Card Reader	Mag Lock	Auto Opener	Hold Open	Hinges	Accessory 1	Accessory 2	Accessory 3	Closer
B	1	915 x 2135	Solid Core	FRL	<input type="checkbox"/>	<input type="checkbox"/>	2 High	<input checked="" type="checkbox"/>	Push/Pull	<input type="checkbox"/>	<input checked="" type="checkbox"/>	<input type="checkbox"/>	<input checked="" type="checkbox"/>	Butt Hinge				Concealed

Door Remarks: Refer to Appendix 10 for door interlocking requirements

Security Grille  
 Anti-barricade strategy

**MILLWORK AND SPECIALTY CASEWORK**

**UPPER UNITS** (U1-U8) **LOWER UNITS** (L1-L12) **RECEPTION/TRANSACTION COUNTER / CARE TEAM STATION DESK** (TC1-TC2) **UTILITY SINK AND COUNTER UNIT** (UC1)

Storage Requirements:

**FINISHES**

Full-height Cabinet:   
 Upper Millwork:   
 Countertop:   
 Lower Millwork:   
 Shelf:

Remarks: Provide ceiling hatches with gaskets.

Category	Min. Length (mm)	Motorized Adjustable Height	Standing Height	Specialty Casework
Category 0 - None		<input type="checkbox"/>	<input type="checkbox"/>	<input type="checkbox"/>
Category 1 - Low (1% - 4%)		<input type="checkbox"/>	<input type="checkbox"/>	<input type="checkbox"/>
Category 2 - Med (5% - 9%)		<input type="checkbox"/>	<input type="checkbox"/>	<input type="checkbox"/>
Category 3 - High (10% or Greater)		<input type="checkbox"/>	<input type="checkbox"/>	<input type="checkbox"/>

**MECHANICAL REQUIREMENTS**

<b>PLUMBING</b> (Quantity) Hand Hygiene Sink: <input type="text"/> Lavatory: <input type="text"/> Kitchen Sink: <input type="text"/> Seamless Kitchen Sink: <input type="text"/> Utility / Process Sink: <input type="text"/> Scrub Sink: <input type="text"/> Floor Sink: <input type="text"/> Plumbing Remarks: <input type="text"/>	Other Fixtures: <input type="checkbox"/> Shower <input type="checkbox"/> Eyewash Station <input type="checkbox"/> Tub <input type="checkbox"/> Eyewash/Shower Station <input type="checkbox"/> Ice Maker <input type="checkbox"/> Emergency Shower <input type="checkbox"/> Water Closet <input type="checkbox"/> Flush Rim Sink <input type="checkbox"/> Instantaneous Hot Water <input type="checkbox"/> Floor Drain <input type="checkbox"/> <input type="checkbox"/> Water Bottle Refill Station Other <input type="text"/>	<b>MED / NON-MED GASES</b> (Quantity) Oxygen: <input type="text"/> Medical Air: <input type="text"/> Medical Vacuum: <input type="text"/> Nitrous Oxide: <input type="text"/> CO2: <input type="text"/> AGSS: <input type="text"/> Nitrogen: <input type="text"/> Laboratory Air: <input type="text"/> Laboratory Vacuum: <input type="text"/> Utility Compressed Air: <input type="text"/> Gas Remarks: <input type="text"/>
---	--	---

**Appendix 1B Minimum Room Requirements**

Room Name:

Program Number(s):

1. J2.03	7.	13.	19.	25.	31.	37.	43.
2.	8.	14.	20.	26.	32.	38.	44.
3.	9.	15.	21.	27.	33.	39.	45.
4.	10.	16.	22.	28.	34.	40.	46.
5.	11.	17.	23.	29.	35.	41.	47.
6.	12.	18.	24.	30.	36.	42.	48.

**ARCHITECTURAL REQUIREMENTS**

<b>WALL AND CEILING</b> Wall Material: <input type="text" value="ARGB 1.2m AFF, GB above"/> Finish: <input type="text" value="EWC"/> Ceiling Material: <input type="text" value="GB"/> Finish: <input type="text" value="ECC"/>	<b>WALL PROTECTION</b> Type: <input type="text" value="ESRP"/> <input checked="" type="checkbox"/> Corner Guards <input type="checkbox"/> Hand Rails <input type="checkbox"/> Bed Bumper / Locator Height: <input type="text" value="2185 mm"/> <input type="checkbox"/> Crash Rails <input type="checkbox"/> Chair Rail	<b>GLAZING</b> <input type="checkbox"/> Interior Glazing	<b>FLOORING TYPES</b> Material: <input type="text" value="VSF"/> Base: <input type="text" value="FCB"/>	<b>ROOM ACCESSORIES</b> <input type="checkbox"/> Coat Hooks <input type="checkbox"/> Ceiling Lift <input checked="" type="checkbox"/> Magnetic Whiteboard <input type="checkbox"/> Mirror <input type="checkbox"/> Infant Change Table <input type="checkbox"/> Privacy Curtain
---	--	---	--	---

- LEGEND:**
- WALL AND CEILING LEGEND:**
- AC Architectural Ceiling
  - ACT Acoustic Ceiling Tile
  - ACT-C Cleanroom
  - ARGB Abuse-Resistant Gypsum Board
  - GB Gypsum Board
  - IRGB Impact-Resistant Gypsum Board
  - KLCT Kitchen Lay-in Ceiling Tile
  - MMRGB Moisture and Mould-Resistant Gypsum Board
  - SACT Security Acoustic Ceiling Tile
- WALL FINISHES LEGEND:**
- EWC Epoxy Wall Coating
  - HPC High Performance Coating
  - PT Paint
- CEILING FINISHES LEGEND:**
- ECC Epoxy Ceiling Coating
  - HPC High Performance Coating
  - PF Prefinished
  - PT Paint
- WALL PROTECTION LEGEND:**
- ESRP Extruded Semi-Rigid PVCu Panel
  - FRL Fibre Reinforced Laminate
  - FRP Fibreglass Reinforced Plastic
  - PVV Protective Vinyl Wallcovering
  - RHIS Rigid High Impact Sheet
  - WSSP Wetwall Solid Surface Panel
  - WVV Wetroom Vinyl Wallcovering
- FLOOR FINISHES LEGEND:**
- CFS Concrete Floor Sealer
  - EFC Epoxy Floor Coating
  - PFC Polyurethane Floor Coating
  - RAF Rubber Athletic Flooring
  - RSF Rubber Sheet Flooring
  - SCF Seamless Cushioned Flooring
  - SDRF Static-Dissipative Rubber Sheet Flooring
  - SDVF Static-Dissipative Vinyl Sheet Flooring
  - VSF Vinyl Sheet Flooring
  - WSVF Wetroom Safety Vinyl Sheet Flooring
- FLOOR BASE LEGEND:**
- FCB Flash Cove Base
  - RB Rubber Base
  - SCF Seamless Cushioned Flooring

**DOORS**

Types:

Type	Qty	Size (mm)	Material	Finish	Side Lt.	Blinds	Protect.	Privacy Film	Function	Card Reader	Mag Lock	Auto Opener	Hold Open	Hinges	Accessory 1	Accessory 2	Accessory 3	Closer
B	1	1220 x 2135	Solid Core	FRL	<input type="checkbox"/>	<input type="checkbox"/>	2 High	<input checked="" type="checkbox"/>	Passage	<input type="checkbox"/>	<input type="checkbox"/>	<input type="checkbox"/>	<input checked="" type="checkbox"/>	Cont. Swing Clear				Surface

Door Remarks:  Security Grille  Anti-barricade strategy

**MILLWORK AND SPECIALTY CASEWORK**

Storage Requirements:

**UPPER UNITS** (U1-U8) **SHELF** (S1)

**FULL-HEIGHT CABINETS** (C1-C5) **LOWER UNITS** (L1-L12) **RECEPTION/TRANSACTION COUNTER / CARE TEAM STATION DESK** (TC1-TC2) **UTILITY SINK AND COUNTER UNIT** (UC1)

Category	Min. Length (mm)	Motorized Adjustable Height	Standing Height	Specialty Casework
2	2400	<input type="checkbox"/>	<input checked="" type="checkbox"/>	<input checked="" type="checkbox"/>

**FINISHES**

Full-height Cabinet:   
 Upper Millwork:   
 Countertop:   
 Lower Millwork:   
 Shelf:

Remarks: Refer to Schedule 1, Section 6.12 (Division 12) for Specialty Casework. Items indicated are diagrammatic, provide specialty casework appropriate for the specific and specialized functions to be performed in the space and to accommodate Equipment. Provide ceiling hatches with gaskets.

**MECHANICAL REQUIREMENTS**

<b>PLUMBING</b> (Quantity) Hand Hygiene Sink: <input type="text"/> Lavatory: <input type="text"/> Kitchen Sink: <input type="text"/> Seamless Kitchen Sink: <input type="text"/> Utility / Process Sink: <input type="text"/> Scrub Sink: <input type="text"/> Floor Sink: <input type="text"/> Plumbing Remarks: <input type="text"/>	Other Fixtures: <input type="checkbox"/> Shower <input type="checkbox"/> Eyewash Station <input type="checkbox"/> Tub <input type="checkbox"/> Eyewash/Shower Station <input type="checkbox"/> Ice Maker <input type="checkbox"/> Emergency Shower <input type="checkbox"/> Water Closet <input type="checkbox"/> Flush Rim Sink <input type="checkbox"/> Instantaneous Hot Water <input type="checkbox"/> Floor Drain <input type="checkbox"/> <input type="checkbox"/> Water Bottle Refill Station Other: <input type="text"/>	<b>MED / NON-MED GASES</b> (Quantity) Oxygen: <input type="text"/> Medical Air: <input type="text"/> Medical Vacuum: <input type="text"/> Nitrous Oxide: <input type="text"/> CO2: <input type="text"/> AGSS: <input type="text"/> Nitrogen: <input type="text"/> Laboratory Air: <input type="text"/> Laboratory Vacuum: <input type="text"/> Utility Compressed Air: <input type="text"/> Gas Remarks: <input type="text"/>
---	---	--

**Appendix 1B Minimum Room Requirements**

Room Name:

Program Number(s):

1. J4.03	7.	13.	19.	25.	31.	37.	43.
2.	8.	14.	20.	26.	32.	38.	44.
3.	9.	15.	21.	27.	33.	39.	45.
4.	10.	16.	22.	28.	34.	40.	46.
5.	11.	17.	23.	29.	35.	41.	47.
6.	12.	18.	24.	30.	36.	42.	48.

**ARCHITECTURAL REQUIREMENTS**

<b>WALL AND CEILING</b> Wall Material: <input type="text" value="ARGB 1.2m AFF, GB above"/> Finish: <input type="text" value="EWC"/> Ceiling Material: <input type="text" value="ACT"/> Finish: <input type="text" value="PF"/>	<b>WALL PROTECTION</b> Type: <input type="text" value="ESRP"/> <input checked="" type="checkbox"/> Corner Guards <input type="checkbox"/> Hand Rails <input type="checkbox"/> Bed Bumper / Locator Height: <input type="text" value="2185 mm"/> <input type="checkbox"/> Crash Rails <input type="checkbox"/> Chair Rail	<b>GLAZING</b> <input type="checkbox"/> Interior Glazing	<b>FLOORING TYPES</b> Material: <input type="text" value="VSF"/> Base: <input type="text" value="FCB"/>	<b>ROOM ACCESSORIES</b> <input type="checkbox"/> Coat Hooks <input type="checkbox"/> Ceiling Lift <input type="checkbox"/> Magnetic Whiteboard <input type="checkbox"/> Mirror <input type="checkbox"/> Infant Change Table <input type="checkbox"/> Privacy Curtain
---	--	---	--	--

- LEGEND:**
- WALL AND CEILING LEGEND:**
- AC Architectural Ceiling
  - ACT Acoustic Ceiling Tile
  - ACT-C Cleanroom
  - ARGB Abuse-Resistant Gypsum Board
  - GB Gypsum Board
  - IRGB Impact-Resistant Gypsum Board
  - KLCT Kitchen Lay-in Ceiling Tile
  - MMRGB Moisture and Mould-Resistant Gypsum Board
  - SACT Security Acoustic Ceiling Tile
- WALL FINISHES LEGEND:**
- EWC Epoxy Wall Coating
  - HPC High Performance Coating
  - PT Paint
- CEILING FINISHES LEGEND:**
- ECC Epoxy Ceiling Coating
  - HPC High Performance Coating
  - PF Prefinished
  - PT Paint
- WALL PROTECTION LEGEND:**
- ESRP Extruded Semi-Rigid PVCu Panel
  - FRL Fibre Reinforced Laminate
  - FRP Fibreglass Reinforced Plastic
  - PVV Protective Vinyl Wallcovering
  - RHIS Rigid High Impact Sheet
  - WSSP Wetwall Solid Surface Panel
  - WVV Wetroom Vinyl Wallcovering
- FLOOR FINISHES LEGEND:**
- CFS Concrete Floor Sealer
  - EFC Epoxy Floor Coating
  - PFC Polyurethane Floor Coating
  - RAF Rubber Athletic Flooring
  - RSF Rubber Sheet Flooring
  - SCF Seamless Cushioned Flooring
  - SDRF Static-Dissipative Rubber Sheet Flooring
  - SDVF Static-Dissipative Vinyl Sheet Flooring
  - VSF Vinyl Sheet Flooring
  - WSVF Wetroom Safety Vinyl Sheet Flooring
- FLOOR BASE LEGEND:**
- FCB Flash Cove Base
  - RB Rubber Base
  - SCF Seamless Cushioned Flooring

**DOORS**

Types:

Type	Qty	Size (mm)	Material	Finish	Side Lt.	Blinds	Protect.	Privacy Film	Function	Card Reader	Mag Lock	Auto Opener	Hold Open	Hinges	Accessory 1	Accessory 2	Accessory 3	Closer
C2	1	1830 x 2135	Solid Core	FRL	<input type="checkbox"/>	<input type="checkbox"/>	2 High	<input checked="" type="checkbox"/>	Passage	<input type="checkbox"/>	<input type="checkbox"/>	<input type="checkbox"/>	<input type="checkbox"/>	Cont. Swing Clear	Astragal	Flush Bolt		Surface

Door Remarks:  Security Grille  Anti-barricade strategy

**MILLWORK AND SPECIALTY CASEWORK**

**UPPER UNITS** (U1-U8) **SHELF** (S1)

**LOWER UNITS** (L1-L12) **RECEPTION/TRANSACTION COUNTER / CARE TEAM STATION DESK** (TC1, TC2) **UTILITY SINK AND COUNTER UNIT** (UC1)

**FULL-HEIGHT CABINETS** (C1-C5)

Storage Requirements:

**FINISHES**

Full-height Cabinet:   
 Upper Millwork:   
 Countertop:   
 Lower Millwork:   
 Shelf:

Remarks:

**Legend:**

Category	Min. Length (mm)	Motorized Adjustable Height	Standing Height	Specialty Casework
Category 0 - None		<input type="checkbox"/>	<input type="checkbox"/>	<input type="checkbox"/>
Category 1 - Low (1% - 4%)		<input type="checkbox"/>	<input type="checkbox"/>	<input type="checkbox"/>
Category 2 - Med (5% - 9%)		<input type="checkbox"/>	<input type="checkbox"/>	<input type="checkbox"/>
Category 3 - High (10% or Greater)		<input type="checkbox"/>	<input type="checkbox"/>	<input type="checkbox"/>

**MECHANICAL REQUIREMENTS**

<b>PLUMBING</b> (Quantity) Hand Hygiene Sink: <input type="text"/> Lavatory: <input type="text"/> Kitchen Sink: <input type="text"/> Seamless Kitchen Sink: <input type="text"/> Utility / Process Sink: <input type="text"/> Scrub Sink: <input type="text"/> Floor Sink: <input type="text"/> Plumbing Remarks: <input type="text"/>	Other Fixtures: <input type="checkbox"/> Shower <input type="checkbox"/> Eyewash Station <input type="checkbox"/> Tub <input type="checkbox"/> Eyewash/Shower Station <input type="checkbox"/> Ice Maker <input type="checkbox"/> Emergency Shower <input type="checkbox"/> Water Closet <input type="checkbox"/> Flush Rim Sink <input type="checkbox"/> Instantaneous Hot Water <input type="checkbox"/> Floor Drain <input type="checkbox"/> <input type="checkbox"/> Water Bottle Refill Station Other <input type="text"/>	<b>MED / NON-MED GASES</b> (Quantity) Oxygen: <input type="text"/> Medical Air: <input type="text"/> Medical Vacuum: <input type="text"/> Nitrous Oxide: <input type="text"/> CO2: <input type="text"/> AGSS: <input type="text"/> Nitrogen: <input type="text"/> Laboratory Air: <input type="text"/> Laboratory Vacuum: <input type="text"/> Utility Compressed Air: <input type="text"/> Gas Remarks: <input type="text"/>
---	--	---



**Appendix 1B Minimum Room Requirements**

Room Name:

Program Number(s):

1. J1.01	7.	13.	19.	25.	31.	37.	43.
2.	8.	14.	20.	26.	32.	38.	44.
3.	9.	15.	21.	27.	33.	39.	45.
4.	10.	16.	22.	28.	34.	40.	46.
5.	11.	17.	23.	29.	35.	41.	47.
6.	12.	18.	24.	30.	36.	42.	48.

**ARCHITECTURAL REQUIREMENTS**

<b>WALL AND CEILING</b> Wall Material: <input type="text" value="ARGB 1.2m AFF, GB above"/> Finish: <input type="text" value="EWC"/> Ceiling Material: <input type="text" value="ACT"/> Finish: <input type="text" value="PF"/>	<b>WALL PROTECTION</b> Type: <input type="text" value="ESRP"/> <input checked="" type="checkbox"/> Corner Guards <input type="checkbox"/> Hand Rails <input type="checkbox"/> Bed Bumper / Locator Height: <input type="text" value="2185 mm"/> <input type="checkbox"/> Crash Rails <input checked="" type="checkbox"/> Chair Rail	<b>GLAZING</b> <input type="checkbox"/> Interior Glazing	<b>FLOORING TYPES</b> Material: <input type="text" value="VSF"/> Base: <input type="text" value="RB"/>	<b>ROOM ACCESSORIES</b> <input checked="" type="checkbox"/> Coat Hooks <input type="checkbox"/> Ceiling Lift <input checked="" type="checkbox"/> Magnetic Whiteboard <input type="checkbox"/> Mirror <input type="checkbox"/> Infant Change Table <input type="checkbox"/> Privacy Curtain
---	---	---	---	--

- LEGEND:**
- WALL AND CEILING LEGEND:**
- AC Architectural Ceiling
  - ACT Acoustic Ceiling Tile
  - ACT-C Cleanroom
  - ARGB Abuse-Resistant Gypsum Board
  - GB Gypsum Board
  - IRGB Impact-Resistant Gypsum Board
  - KLCT Kitchen Lay-in Ceiling Tile
  - MMRGB Moisture and Mould-Resistant Gypsum Board
  - SACT Security Acoustic Ceiling Tile
- WALL FINISHES LEGEND:**
- EWC Epoxy Wall Coating
  - HPC High Performance Coating
  - PT Paint
- CEILING FINISHES LEGEND:**
- ECC Epoxy Ceiling Coating
  - HPC High Performance Coating
  - PF Prefinished
  - PT Paint
- WALL PROTECTION LEGEND:**
- ESRP Extruded Semi-Rigid PVCu Panel
  - FRL Fibre Reinforced Laminiate
  - FRP Fibreglass Reinforced Plastic
  - PVV Protective Vinyl Wallcovering
  - RHIS Rigid High Impact Sheet
  - WSSP Wetwall Solid Surface Panel
  - WVV Wetroom Vinyl Wallcovering
- FLOOR FINISHES LEGEND:**
- CFS Concrete Floor Sealer
  - EFC Epoxy Floor Coating
  - PFC Polyurethane Floor Coating
  - RAF Rubber Athletic Flooring
  - RSF Rubber Sheet Flooring
  - SCF Seamless Cushioned Flooring
  - SDRF Static-Dissipative Rubber Sheet Flooring
  - SDVF Static-Dissipative Vinyl Sheet Flooring
  - VSF Vinyl Sheet Flooring
  - WSVF Wetroom Safety Vinyl Sheet Flooring
- FLOOR BASE LEGEND:**
- FCB Flash Cove Base
  - RB Rubber Base
  - SCF Seamless Cushioned Flooring

**DOORS**

Types:

Type	Qty	Size (mm)	Material	Finish	Side Lt	Blinds	Protect	Privacy Film	Function	Card Reader	Mag Lock	Auto Opener	Hold Open	Hinges	Accessory 1	Accessory 2	Accessory 3	Closer
B	1	915 x 2135	Solid Core	FRL	<input type="checkbox"/>	<input type="checkbox"/>	2 High	<input checked="" type="checkbox"/>	Storeroom	<input checked="" type="checkbox"/>	<input type="checkbox"/>	<input type="checkbox"/>	<input type="checkbox"/>	Butt Hinge				Surface

Door Remarks:  Security Grille  Anti-barricade strategy

**MILLWORK AND SPECIALTY CASEWORK**

**UPPER UNITS:** U1, U2, U3, U4, U5, U6, U7, U8

**LOWER UNITS:** L1, L2, L3, L4, L5, L6, L7, L8, L9, L10, L11, L12

**RECEPTION/TRANSACTION COUNTER / CARE TEAM STATION DESK:** TC1, TC2

**UTILITY SINK AND COUNTER UNIT:** UC1

**Storage Requirements:**  SHELF  S1

**Legend:**

Category	Min. Length (mm)	Motorized Adjustable Height	Standing Height	Specialty Casework
Category 0 - None				
Category 1 - Low (1% - 4%)				
Category 2 - Med (5% - 9%)				
Category 3 - High (10% or Greater)				<input checked="" type="checkbox"/>

**FINISHES**

Full-height Cabinet:

Upper Millwork:

Countertop:

Lower Millwork:

Shelf:

Remarks: Refer to Schedule 1, Section 6.12 (Division 12) for Specialty Casework Provide 1 Large sorting counter/workbench (2.5nsm) and 7 standing height workstations (2.8nsm) for Pharmacists/Techs.

**MECHANICAL REQUIREMENTS**

<b>PLUMBING</b> (Quantity) Hand Hygiene Sink: <input type="text"/> Lavatory: <input type="text"/> Kitchen Sink: <input type="text"/> Seamless Kitchen Sink: <input type="text"/> Utility / Process Sink: <input type="text"/> Scrub Sink: <input type="text"/> Floor Sink: <input type="text"/> Plumbing Remarks: <input type="text"/>	Other Fixtures: <input type="checkbox"/> Shower <input type="checkbox"/> Tub <input type="checkbox"/> Ice Maker <input type="checkbox"/> Water Closet <input type="checkbox"/> Instantaneous Hot Water <input type="checkbox"/> Eyewash Station <input type="checkbox"/> Eyewash/Shower Station <input type="checkbox"/> Emergency Shower <input type="checkbox"/> Flush Rim Sink <input type="checkbox"/> Floor Drain <input type="checkbox"/> Water Bottle Refill Station Other: <input type="text"/>	<b>MED / NON-MED GASES</b> (Quantity) Oxygen: <input type="text"/> Medical Air: <input type="text"/> Medical Vacuum: <input type="text"/> Nitrous Oxide: <input type="text"/> CO2: <input type="text"/> AGSS: <input type="text"/> Nitrogen: <input type="text"/> Laboratory Air: <input type="text"/> Laboratory Vacuum: <input type="text"/> Utility Compressed Air: <input type="text"/> Gas Remarks: <input type="text"/>
---	--	---

**Appendix 1B Minimum Room Requirements**

Room Name:

Program Number(s):

1. J2.07	7.	13.	19.	25.	31.	37.	43.
2.	8.	14.	20.	26.	32.	38.	44.
3.	9.	15.	21.	27.	33.	39.	45.
4.	10.	16.	22.	28.	34.	40.	46.
5.	11.	17.	23.	29.	35.	41.	47.
6.	12.	18.	24.	30.	36.	42.	48.

**ARCHITECTURAL REQUIREMENTS**

<b>WALL AND CEILING</b> Wall Material: <input type="text" value="ARGB 1.2m AFF, GB above"/> Finish: <input type="text" value="EWC"/> Ceiling Material: <input type="text" value="ACT-C"/> Finish: <input type="text" value="PF"/>	<b>WALL PROTECTION</b> Type: <input type="text" value="ESRP"/> <input checked="" type="checkbox"/> Corner Guards <input type="checkbox"/> Hand Rails <input type="checkbox"/> Bed Bumper / Locator Height: <input type="text" value="2185 mm"/> <input type="checkbox"/> Crash Rails <input type="checkbox"/> Chair Rail	<b>GLAZING</b> <input checked="" type="checkbox"/> Interior Glazing	<b>FLOORING TYPES</b> Material: <input type="text" value="RSF"/> Base: <input type="text" value="FCB"/>	<b>ROOM ACCESSORIES</b> <input checked="" type="checkbox"/> Coat Hooks <input type="checkbox"/> Ceiling Lift <input checked="" type="checkbox"/> Magnetic Whiteboard <input type="checkbox"/> Mirror <input type="checkbox"/> Infant Change Table <input type="checkbox"/> Privacy Curtain
---	--	--	--	--

- LEGEND:**
- WALL AND CEILING LEGEND:**
- AC Architectural Ceiling
  - ACT Acoustic Ceiling Tile
  - ACT-C Cleanroom
  - ARGB Abuse-Resistant Gypsum Board
  - GB Gypsum Board
  - IRGB Impact-Resistant Gypsum Board
  - KLCT Kitchen Lay-in Ceiling Tile
  - MMRGB Moisture and Mould-Resistant Gypsum Board
  - SACT Security Acoustic Ceiling Tile
- WALL FINISHES LEGEND:**
- EWC Epoxy Wall Coating
  - HPC High Performance Coating
  - PT Paint
- CEILING FINISHES LEGEND:**
- ECC Epoxy Ceiling Coating
  - HPC High Performance Coating
  - PF Prefinished
  - PT Paint
- WALL PROTECTION LEGEND:**
- ESRP Extruded Semi-Rigid PVCu Panel
  - FRL Fibre Reinforced Laminate
  - FRP Fibreglass Reinforced Plastic
  - PVV Protective Vinyl Wallcovering
  - RHIS Rigid High Impact Sheet
  - WSSP Wetwall Solid Surface Panel
  - WWW Wetroom Vinyl Wallcovering
- FLOOR FINISHES LEGEND:**
- CFS Concrete Floor Sealer
  - EFC Epoxy Floor Coating
  - PFC Polyurethane Floor Coating
  - RAF Rubber Athletic Flooring
  - RSF Rubber Sheet Flooring
  - SCF Seamless Cushioned Flooring
  - SDRF Static-Dissipative Rubber Sheet Flooring
  - SDVF Static-Dissipative Vinyl Sheet Flooring
  - VSF Vinyl Sheet Flooring
  - WSVF Wetroom Safety Vinyl Sheet Flooring
- FLOOR BASE LEGEND:**
- FCB Flash Cove Base
  - RB Rubber Base
  - SCF Seamless Cushioned Flooring

**DOORS**

Types:

Type	Qty	Size (mm)	Material	Finish	Side Lt.	Blinds	Protect.	Privacy Film	Function	Card Reader	Mag Lock	Auto Opener	Hold Open	Hinges	Accessory 1	Accessory 2	Accessory 3	Closer
					<input type="checkbox"/>	<input type="checkbox"/>		<input type="checkbox"/>		<input type="checkbox"/>	<input type="checkbox"/>	<input type="checkbox"/>	<input type="checkbox"/>					

Door Remarks:  Security Grille  Anti-barricade strategy

**MILLWORK AND SPECIALTY CASEWORK**

Storage Requirements:

**UPPER UNITS**

**LOWER UNITS**

**RECEPTION/TRANSACTION COUNTER / CARE TEAM STATION DESK**

**UTILITY SINK AND COUNTER UNIT**

**FULL-HEIGHT CABINETS**

Category	Min. Length (mm)	Motorized Adjustable Height	Standing Height	Specialty Casework
3	9000	<input type="checkbox"/>	<input checked="" type="checkbox"/>	<input checked="" type="checkbox"/>

**FINISHES**

Full-height Cabinet:   
 Upper Millwork:   
 Countertop:   
 Lower Millwork:   
 Shelf:

Remarks: Refer to Schedule 1, Section 6.12 (Division 12) for Specialty Casework. Items indicated are diagrammatic, provide specialty casework appropriate for the specific and specialized functions to be performed in the space and to accommodate Equipment. Provide standing height counter with sorting surface for 4 staff for IV Setup and 2 computers and shelving. Computers are on standing height counter.

**MECHANICAL REQUIREMENTS**

<b>PLUMBING</b> (Quantity) Hand Hygiene Sink: <input type="text"/> Lavatory: <input type="text"/> Kitchen Sink: <input type="text"/> Seamless Kitchen Sink: <input type="text"/> Utility / Process Sink: <input type="text" value="1"/> Scrub Sink: <input type="text"/> Floor Sink: <input type="text"/> Plumbing Remarks: <input type="text"/>	Other Fixtures: <input type="checkbox"/> Shower <input type="checkbox"/> Tub <input type="checkbox"/> Ice Maker <input type="checkbox"/> Water Closet <input type="checkbox"/> Instantaneous Hot Water <input type="checkbox"/> Ewwash Station <input type="checkbox"/> Ewwash/Shower Station <input type="checkbox"/> Emergency Shower <input type="checkbox"/> Flush Rim Sink <input type="checkbox"/> Floor Drain <input type="checkbox"/> Water Bottle Refill Station Other: <input type="text"/>	<b>MED / NON-MED GASES</b> (Quantity) Oxygen: <input type="text"/> Medical Air: <input type="text"/> Medical Vacuum: <input type="text"/> Nitrous Oxide: <input type="text"/> CO2: <input type="text"/> AGSS: <input type="text"/> Nitrogen: <input type="text"/> Laboratory Air: <input type="text"/> Laboratory Vacuum: <input type="text"/> Utility Compressed Air: <input type="text"/> Gas Remarks: <input type="text"/>
---	--	---

---

# New Surrey Hospital & BC Cancer Centre

MINIMUM ROOM REQUIREMENTS

## **K. Radiation Therapy Planning**

---



**Appendix 1B Minimum Room Requirements**

Room Name:

Program Number(s):

1. K1.15	7.	13.	19.	25.	31.	37.	43.
2.	8.	14.	20.	26.	32.	38.	44.
3.	9.	15.	21.	27.	33.	39.	45.
4.	10.	16.	22.	28.	34.	40.	46.
5.	11.	17.	23.	29.	35.	41.	47.
6.	12.	18.	24.	30.	36.	42.	48.

**ARCHITECTURAL REQUIREMENTS**

<b>WALL AND CEILING</b> Wall Material: <input type="text" value="GB"/> Finish: <input type="text" value="PT"/> Ceiling Material: <input type="text" value="ACT"/> Finish: <input type="text" value="PF"/>	<b>WALL PROTECTION</b> Type: <input type="text" value="PVW"/> <input checked="" type="checkbox"/> Corner Guards <input type="checkbox"/> Hand Rails <input type="checkbox"/> Bed Bumper / Locator Height: <input type="text" value="1350 mm"/> <input type="checkbox"/> Crash Rails <input type="checkbox"/> Chair Rail	<b>GLAZING</b> <input type="checkbox"/> Interior Glazing	<b>FLOORING TYPES</b> Material: <input type="text" value="RSF"/> Base: <input type="text" value="RB"/>	<b>ROOM ACCESSORIES</b> <input type="checkbox"/> Coat Hooks <input type="checkbox"/> Ceiling Lift <input type="checkbox"/> Magnetic Whiteboard <input type="checkbox"/> Mirror <input type="checkbox"/> Infant Change Table <input type="checkbox"/> Privacy Curtain
---	---	---	---	--

- LEGEND:**
- WALL AND CEILING LEGEND:**
- AC Architectural Ceiling
  - ACT Acoustic Ceiling Tile
  - ACT-C Cleanroom
  - ARGB Abuse-Resistant Gypsum Board
  - GB Gypsum Board
  - IRGB Impact-Resistant Gypsum Board
  - KLCT Kitchen Lay-in Ceiling Tile
  - MMRGB Moisture and Mould-Resistant Gypsum Board
  - SACT Security Acoustic Ceiling Tile
- WALL FINISHES LEGEND:**
- EWC Epoxy Wall Coating
  - HPC High Performance Coating
  - PT Paint
- CEILING FINISHES LEGEND:**
- ECC Epoxy Ceiling Coating
  - HPC High Performance Coating
  - PF Prefinished
  - PT Paint
- WALL PROTECTION LEGEND:**
- ESRP Extruded Semi-Rigid PVCu Panel
  - FRL Fibre Reinforced Laminate
  - FRP Fibreglass Reinforced Plastic
  - PVW Protective Vinyl Wallcovering
  - RHIS Rigid High Impact Sheet
  - WSSP Wetwall Solid Surface Panel
  - WVV Wetroom Vinyl Wallcovering
- FLOOR FINISHES LEGEND:**
- CFS Concrete Floor Sealer
  - EFC Epoxy Floor Coating
  - PFC Polyurethane Floor Coating
  - RAF Rubber Athletic Flooring
  - RSF Rubber Sheet Flooring
  - SCF Seamless Cushioned Flooring
  - SDRF Static-Dissipative Rubber Sheet Flooring
  - SDVF Static-Dissipative Vinyl Sheet Flooring
  - VSF Vinyl Sheet Flooring
  - WSVF Wetroom Safety Vinyl Sheet Flooring
- FLOOR BASE LEGEND:**
- FCB Flash Cove Base
  - RB Rubber Base
  - SCF Seamless Cushioned Flooring

**DOORS**

Types:

Type	Qty	Size (mm)	Material	Finish	Side Lt.	Blinds	Protect.	Privacy Film	Function	Card Reader	Mag Lock	Auto Opener	Hold Open	Hinges	Accessory 1	Accessory 2	Accessory 3	Closer
B	1	1065 x 2135	Hollow Metal	Paint	<input type="checkbox"/>	<input type="checkbox"/>	1 Low	<input type="checkbox"/>	Storeroom	<input checked="" type="checkbox"/>	<input type="checkbox"/>	<input type="checkbox"/>	<input type="checkbox"/>	Butt Hinge				

**DOOR REMARKS:**

Security Grille  
 Anti-barricade strategy

**MILLWORK AND SPECIALTY CASEWORK**

Storage Requirements:

**UPPER UNITS:** U1, U2, U3, U4, U5, U6, U7, U8

**LOWER UNITS:** L1, L2, L3, L4, L5, L6, L7, L8, L9, L10, L11, L12

**RECEPTION/TRANSACTION COUNTER / CARE TEAM STATION DESK:** TC1, TC2

**UTILITY SINK AND COUNTER UNIT:** UC1

**SHELF:** S1

**FULL-HEIGHT CABINETS:** C1, C2, C3, C4, C5

**Legend:**

Category	Min. Length (mm)	Motorized Adjustable Height	Standing Height	Specialty Casework
Category 0 - None				
Category 1 - Low (1% - 4%)				
Category 2 - Med (5% - 9%)				
Category 3 - High (10% or Greater)	3	1800	<input type="checkbox"/>	<input type="checkbox"/>

**FINISHES**

Full-height Cabinet:

Upper Millwork:

Countertop:

Lower Millwork:

Shelf:

**REMARKS:**

**MECHANICAL REQUIREMENTS**

**PLUMBING**

Hand Hygiene Sink:	Lavatory:	Kitchen Sink:	Seamless Kitchen Sink:	Utility / Process Sink:	Scrub Sink:	Floor Sink:
<input type="text"/>	<input type="text"/>	<input type="text"/>	<input type="text"/>	<input type="text"/>	<input type="text"/>	<input type="text"/>

Plumbing Remarks:

**Other Fixtures:**

- Shower
- Tub
- Ice Maker
- Water Closet
- Instantaneous Hot Water
- Eyewash Station
- Eyewash/Shower Station
- Emergency Shower
- Flush Rim Sink
- Floor Drain
- Water Bottle Refill Station

Other:

**MED / NON-MED GASES**

Oxygen:	Medical Air:	Medical Vacuum:	Nitrous Oxide:	CO2:	AGSS:	Nitrogen:	Laboratory Air:	Laboratory Vacuum:	Utility Compressed Air:
<input type="text"/>	<input type="text"/>	<input type="text"/>	<input type="text"/>	<input type="text"/>	<input type="text"/>	<input type="text"/>	<input type="text"/>	<input type="text"/>	<input type="text"/>

Gas Remarks:

**Appendix 1B Minimum Room Requirements**

Room Name:

Program Number(s):

1. K3.10	7.	13.	19.	25.	31.	37.	43.
2.	8.	14.	20.	26.	32.	38.	44.
3.	9.	15.	21.	27.	33.	39.	45.
4.	10.	16.	22.	28.	34.	40.	46.
5.	11.	17.	23.	29.	35.	41.	47.
6.	12.	18.	24.	30.	36.	42.	48.

**ARCHITECTURAL REQUIREMENTS**

<b>WALL AND CEILING</b> Wall Material: <input type="text" value="ARGB 1.2m AFF, GB above"/> Finish: <input type="text" value="PT"/> Ceiling Material: <input type="text" value="ACT"/> Finish: <input type="text" value="PF"/>	<b>WALL PROTECTION</b> Type: <input type="text" value="RHIS"/> <input checked="" type="checkbox"/> Corner Guards <input type="checkbox"/> Hand Rails <input type="checkbox"/> Bed Bumper / Locator Height: <input type="text" value="1350 mm"/> <input type="checkbox"/> Crash Rails <input type="checkbox"/> Chair Rail	<b>GLAZING</b> <input type="checkbox"/> Interior Glazing	<b>FLOORING TYPES</b> Material: <input type="text" value="SDVF"/> Base: <input type="text" value="FCB"/>	<b>ROOM ACCESSORIES</b> <input type="checkbox"/> Coat Hooks <input type="checkbox"/> Ceiling Lift <input type="checkbox"/> Magnetic Whiteboard <input type="checkbox"/> Mirror <input type="checkbox"/> Infant Change Table <input type="checkbox"/> Privacy Curtain
--	--	---	---	--

- LEGEND:**
- WALL AND CEILING LEGEND:**
- AC Architectural Ceiling
  - ACT Acoustic Ceiling Tile
  - ACT-C Cleanroom
  - ARGB Abuse-Resistant Gypsum Board
  - GB Gypsum Board
  - IRGB Impact-Resistant Gypsum Board
  - KLCT Kitchen Lay-in Ceiling Tile
  - MMRGB Moisture and Mould-Resistant Gypsum Board
  - SACT Security Acoustic Ceiling Tile
- WALL FINISHES LEGEND:**
- EWC Epoxy Wall Coating
  - HPC High Performance Coating
  - PT Paint
- CEILING FINISHES LEGEND:**
- ECC Epoxy Ceiling Coating
  - HPC High Performance Coating
  - PF Prefinished
  - PT Paint
- WALL PROTECTION LEGEND:**
- ESRP Extruded Semi-Rigid PVCu Panel
  - FRL Fibre Reinforced Laminate
  - FRP Fibreglass Reinforced Plastic
  - PVV Protective Vinyl Wallcovering
  - RHIS Rigid High Impact Sheet
  - WSSP Wetwall Solid Surface Panel
  - WVV Wetroom Vinyl Wallcovering
- FLOOR FINISHES LEGEND:**
- CFS Concrete Floor Sealer
  - EFC Epoxy Floor Coating
  - PFC Polyurethane Floor Coating
  - RAF Rubber Athletic Flooring
  - RSF Rubber Sheet Flooring
  - SCF Seamless Cushioned Flooring
  - SDRF Static-Dissipative Rubber Sheet Flooring
  - SDVF Static-Dissipative Vinyl Sheet Flooring
  - VSF Vinyl Sheet Flooring
  - WSVF Wetroom Safety Vinyl Sheet Flooring
- FLOOR BASE LEGEND:**
- FCB Flash Cove Base
  - RB Rubber Base
  - SCF Seamless Cushioned Flooring

**DOORS**

Types:

Type	Qty	Size (mm)	Material	Finish	Side Lt.	Blinds	Protect.	Privacy Film	Function	Card Reader	Mag Lock	Auto Opener	Hold Open	Hinges	Accessory 1	Accessory 2	Accessory 3	Closer
A	1	1220 x 2135	Solid Core	FRL	<input type="checkbox"/>	<input type="checkbox"/>	1 Low	<input type="checkbox"/>	Storeroom	<input checked="" type="checkbox"/>	<input type="checkbox"/>	<input type="checkbox"/>	<input checked="" type="checkbox"/>	Butt Hinge				Surface

Door Remarks:  Security Grille  Anti-barricade strategy



**MECHANICAL REQUIREMENTS**

<b>PLUMBING</b> (Quantity) Hand Hygiene Sink: <input type="text"/> Lavatory: <input type="text"/> Kitchen Sink: <input type="text"/> Seamless Kitchen Sink: <input type="text"/> Utility / Process Sink: <input type="text"/> Scrub Sink: <input type="text"/> Floor Sink: <input type="text"/> Plumbing Remarks: <input type="text"/>	Other Fixtures: <input type="checkbox"/> Shower <input type="checkbox"/> Eyewash Station <input type="checkbox"/> Tub <input type="checkbox"/> Eyewash/Shower Station <input type="checkbox"/> Ice Maker <input type="checkbox"/> Emergency Shower <input type="checkbox"/> Water Closet <input type="checkbox"/> Flush Rim Sink <input type="checkbox"/> Instantaneous Hot Water <input type="checkbox"/> Floor Drain <input type="checkbox"/> <input type="checkbox"/> Water Bottle Refill Station Other <input type="text"/>	<b>MED / NON-MED GASES</b> (Quantity) Oxygen: <input type="text"/> Medical Air: <input type="text"/> Medical Vacuum: <input type="text"/> Nitrous Oxide: <input type="text"/> CO2: <input type="text"/> AGSS: <input type="text"/> Nitrogen: <input type="text"/> Laboratory Air: <input type="text"/> Laboratory Vacuum: <input type="text"/> Utility Compressed Air: <input type="text"/> Gas Remarks: <input type="text"/>
---	--	---

**Appendix 1B Minimum Room Requirements**

Room Name:

Program Number(s):

1. K4.09	7.	13.	19.	25.	31.	37.	43.
2.	8.	14.	20.	26.	32.	38.	44.
3.	9.	15.	21.	27.	33.	39.	45.
4.	10.	16.	22.	28.	34.	40.	46.
5.	11.	17.	23.	29.	35.	41.	47.
6.	12.	18.	24.	30.	36.	42.	48.

**ARCHITECTURAL REQUIREMENTS**

<b>WALL AND CEILING</b> Wall Material: <input type="text" value="ARGB 1.2m AFF, GB above"/> Finish: <input type="text" value="PT"/> Ceiling Material: <input type="text" value="ACT"/> Finish: <input type="text" value="PF"/>	<b>WALL PROTECTION</b> Type: <input type="text" value="RHIS"/> <input checked="" type="checkbox"/> Corner Guards <input type="checkbox"/> Hand Rails <input type="checkbox"/> Bed Bumper / Locator Height: <input type="text" value="1350 mm"/> <input type="checkbox"/> Crash Rails <input type="checkbox"/> Chair Rail	<b>GLAZING</b> <input type="checkbox"/> Interior Glazing	<b>FLOORING TYPES</b> Material: <input type="text" value="SDVF"/> Base: <input type="text" value="FCB"/>	<b>ROOM ACCESSORIES</b> <input type="checkbox"/> Coat Hooks <input type="checkbox"/> Ceiling Lift <input type="checkbox"/> Magnetic Whiteboard <input type="checkbox"/> Mirror <input type="checkbox"/> Infant Change Table <input type="checkbox"/> Privacy Curtain
--	--	---	---	--

- LEGEND:**
- WALL AND CEILING LEGEND:**
- AC Architectural Ceiling
  - ACT Acoustic Ceiling Tile
  - ACT-C Cleanroom
  - ARGB Abuse-Resistant Gypsum Board
  - GB Gypsum Board
  - IRGB Impact-Resistant Gypsum Board
  - KLCT Kitchen Lay-in Ceiling Tile
  - MMRGB Moisture and Mould-Resistant Gypsum Board
  - SACT Security Acoustic Ceiling Tile
- WALL FINISHES LEGEND:**
- EWC Epoxy Wall Coating
  - HPC High Performance Coating
  - PT Paint
- CEILING FINISHES LEGEND:**
- ECC Epoxy Ceiling Coating
  - HPC High Performance Coating
  - PF Prefinished
  - PT Paint
- WALL PROTECTION LEGEND:**
- ESRP Extruded Semi-Rigid PVCu Panel
  - FRL Fibre Reinforced Laminate
  - FRP Fibreglass Reinforced Plastic
  - PVV Protective Vinyl Wallcovering
  - RHIS Rigid High Impact Sheet
  - WSSP Wetwall Solid Surface Panel
  - WVV Wetroom Vinyl Wallcovering
- FLOOR FINISHES LEGEND:**
- CFS Concrete Floor Sealer
  - EFC Epoxy Floor Coating
  - PFC Polyurethane Floor Coating
  - RAF Rubber Athletic Flooring
  - RSF Rubber Sheet Flooring
  - SCF Seamless Cushioned Flooring
  - SDRF Static-Dissipative Rubber Sheet Flooring
  - SDVF Static-Dissipative Vinyl Sheet Flooring
  - VSF Vinyl Sheet Flooring
  - WSVF Wetroom Safety Vinyl Sheet Flooring
- FLOOR BASE LEGEND:**
- FCB Flash Cove Base
  - RB Rubber Base
  - SCF Seamless Cushioned Flooring

**DOORS**

Types:

Type	Qty	Size (mm)	Material	Finish	Side Lt.	Blinds	Protect.	Privacy Film	Function	Card Reader	Mag Lock	Auto Opener	Hold Open	Hinges	Accessory 1	Accessory 2	Accessory 3	Closer
A	1	1220 x 2135	Solid Core	FRL	<input type="checkbox"/>	<input type="checkbox"/>	1 Low	<input type="checkbox"/>	Storeroom	<input checked="" type="checkbox"/>	<input type="checkbox"/>	<input type="checkbox"/>	<input checked="" type="checkbox"/>	Butt Hinge				Surface

Door Remarks:  Security Grille  Anti-barricade strategy

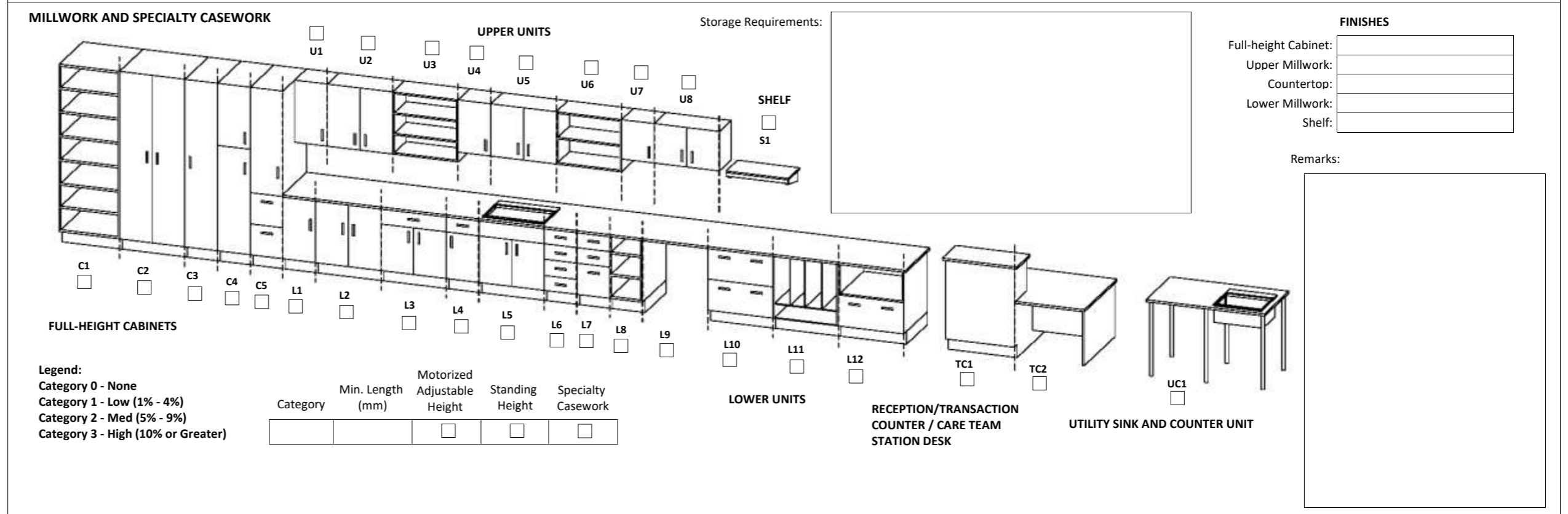

**MECHANICAL REQUIREMENTS**

<b>PLUMBING</b> (Quantity) Hand Hygiene Sink: <input type="text"/> Lavatory: <input type="text"/> Kitchen Sink: <input type="text"/> Seamless Kitchen Sink: <input type="text"/> Utility / Process Sink: <input type="text"/> Scrub Sink: <input type="text"/> Floor Sink: <input type="text"/> Plumbing Remarks: <input type="text"/>	Other Fixtures: <input type="checkbox"/> Shower <input type="checkbox"/> Eyewash Station <input type="checkbox"/> Tub <input type="checkbox"/> Eyewash/Shower Station <input type="checkbox"/> Ice Maker <input type="checkbox"/> Emergency Shower <input type="checkbox"/> Water Closet <input type="checkbox"/> Flush Rim Sink <input type="checkbox"/> Instantaneous Hot Water <input type="checkbox"/> Floor Drain <input type="checkbox"/> <input type="checkbox"/> Water Bottle Refill Station Other: <input type="text"/>	<b>MED / NON-MED GASES</b> (Quantity) Oxygen: <input type="text"/> Medical Air: <input type="text"/> Medical Vacuum: <input type="text"/> Nitrous Oxide: <input type="text"/> CO2: <input type="text"/> AGSS: <input type="text"/> Nitrogen: <input type="text"/> Laboratory Air: <input type="text"/> Laboratory Vacuum: <input type="text"/> Utility Compressed Air: <input type="text"/> Gas Remarks: <input type="text"/>
---	---	---



**Appendix 1B Minimum Room Requirements**

Room Name:

Program Number(s):

1.	K3.09	7.		13.		19.		25.		31.		37.		43.
2.		8.		14.		20.		26.		32.		38.		44.
3.		9.		15.		21.		27.		33.		39.		45.
4.		10.		16.		22.		28.		34.		40.		46.
5.		11.		17.		23.		29.		35.		41.		47.
6.		12.		18.		24.		30.		36.		42.		48.

**ARCHITECTURAL REQUIREMENTS**

<b>WALL AND CEILING</b> Wall Material: <input type="text" value="ARGB 1.2m AFF, GB above"/> Finish: <input type="text" value="PT"/> Ceiling Material: <input type="text" value="ACT"/> Finish: <input type="text" value="PF"/>	<b>WALL PROTECTION</b> Type: <input type="text" value="FRP"/> <input checked="" type="checkbox"/> Corner Guards <input type="checkbox"/> Hand Rails <input type="checkbox"/> Bed Bumper / Locator Height: <input type="text" value="1600 mm"/> <input type="checkbox"/> Crash Rails <input checked="" type="checkbox"/> Chair Rail	<b>GLAZING</b> <input checked="" type="checkbox"/> Interior Glazing	<b>FLOORING TYPES</b> Material: <input type="text" value="SDVF"/> Base: <input type="text" value="FCB"/>	<b>ROOM ACCESSORIES</b> <input type="checkbox"/> Coat Hooks <input type="checkbox"/> Ceiling Lift <input checked="" type="checkbox"/> Magnetic Whiteboard <input type="checkbox"/> Mirror <input type="checkbox"/> Infant Change Table <input type="checkbox"/> Privacy Curtain
--	--	--	---	---

- LEGEND:**
- WALL AND CEILING LEGEND:**
- AC Architectural Ceiling
  - ACT Acoustic Ceiling Tile
  - ACT-C Cleanroom
  - ARGB Abuse-Resistant Gypsum Board
  - GB Gypsum Board
  - IRGB Impact-Resistant Gypsum Board
  - KLCT Kitchen Lay-in Ceiling Tile
  - MMRGB Moisture and Mould-Resistant Gypsum Board
  - SACT Security Acoustic Ceiling Tile
- WALL FINISHES LEGEND:**
- EWC Epoxy Wall Coating
  - HPC High Performance Coating
  - PT Paint
- CEILING FINISHES LEGEND:**
- ECC Epoxy Ceiling Coating
  - HPC High Performance Coating
  - PF Prefinished
  - PT Paint
- WALL PROTECTION LEGEND:**
- ESRP Extruded Semi-Rigid PVCu Panel
  - FRL Fibre Reinforced Laminate
  - FRP Fibreglass Reinforced Plastic
  - PVV Protective Vinyl Wallcovering
  - RHIS Rigid High Impact Sheet
  - WSSP Wetwall Solid Surface Panel
  - WVV Wetroom Vinyl Wallcovering
- FLOOR FINISHES LEGEND:**
- CFS Concrete Floor Sealer
  - EFC Epoxy Floor Coating
  - PFC Polyurethane Floor Coating
  - RAF Rubber Athletic Flooring
  - RSF Rubber Sheet Flooring
  - SCF Seamless Cushioned Flooring
  - SDRF Static-Dissipative Rubber Sheet Flooring
  - SDVF Static-Dissipative Vinyl Sheet Flooring
  - VSF Vinyl Sheet Flooring
  - WSVF Wetroom Safety Vinyl Sheet Flooring
- FLOOR BASE LEGEND:**
- FCB Flash Cove Base
  - RB Rubber Base
  - SCF Seamless Cushioned Flooring

**DOORS**

Types:

Type	Qty	Size (mm)	Material	Finish	Side Lt.	Blinds	Protect.	Privacy Film	Function	Card Reader	Mag Lock	Auto Opener	Hold Open	Hinges	Accessory 1	Accessory 2	Accessory 3	Closer
C	1	1065 x 2135	Solid Core	FRL	<input type="checkbox"/>	<input checked="" type="checkbox"/>	1 Low	<input type="checkbox"/>	Storeroom	<input checked="" type="checkbox"/>	<input type="checkbox"/>	<input type="checkbox"/>	<input type="checkbox"/>	Butt Hinge				Surface
B	2	1065 x 2135	Shielded	Prefinished	<input type="checkbox"/>	<input type="checkbox"/>	1 Low	<input type="checkbox"/>	Passage	<input type="checkbox"/>	<input type="checkbox"/>	<input type="checkbox"/>	<input type="checkbox"/>	Butt Hinge				Surface

Door Remarks:  Security Grille  Anti-barricade strategy

**MILLWORK AND SPECIALTY CASEWORK**

Storage Requirements:

**UPPER UNITS** (U1-U8) **SHELF** (S1)

**FULL-HEIGHT CABINETS** (C1-C5) **LOWER UNITS** (L1-L12) **RECEPTION/TRANSACTION COUNTER / CARE TEAM STATION DESK** (TC1-TC2) **UTILITY SINK AND COUNTER UNIT** (UC1)

Category	Min. Length (mm)	Motorized Adjustable Height	Standing Height	Specialty Casework
3	1800	<input type="checkbox"/>	<input type="checkbox"/>	<input type="checkbox"/>

**FINISHES**

Full-height Cabinet:

Upper Millwork:

Countertop:

Lower Millwork:

Shelf:

Remarks:

**MECHANICAL REQUIREMENTS**

<b>PLUMBING</b> (Quantity) Hand Hygiene Sink: <input type="text" value="1"/> Lavatory: <input type="text"/> Kitchen Sink: <input type="text"/> Seamless Kitchen Sink: <input type="text"/> Utility / Process Sink: <input type="text"/> Scrub Sink: <input type="text"/> Floor Sink: <input type="text"/> Plumbing Remarks: <input type="text"/>	Other Fixtures: <input type="checkbox"/> Shower <input type="checkbox"/> Tub <input type="checkbox"/> Ice Maker <input type="checkbox"/> Water Closet <input type="checkbox"/> Instantaneous Hot Water <input type="checkbox"/> Eyewash Station <input type="checkbox"/> Eyewash/Shower Station <input type="checkbox"/> Emergency Shower <input type="checkbox"/> Flush Rim Sink <input type="checkbox"/> Floor Drain <input type="checkbox"/> Water Bottle Refill Station Other: <input type="text"/>	<b>MED / NON-MED GASES</b> (Quantity) Oxygen: <input type="text"/> Medical Air: <input type="text"/> Medical Vacuum: <input type="text"/> Nitrous Oxide: <input type="text"/> CO2: <input type="text"/> AGSS: <input type="text"/> Nitrogen: <input type="text"/> Laboratory Air: <input type="text"/> Laboratory Vacuum: <input type="text"/> Utility Compressed Air: <input type="text"/> Gas Remarks: <input type="text"/>
--	--	---

**Appendix 1B Minimum Room Requirements**

Room Name:

Program Number(s):

1. K4.08	7.	13.	19.	25.	31.	37.	43.
2.	8.	14.	20.	26.	32.	38.	44.
3.	9.	15.	21.	27.	33.	39.	45.
4.	10.	16.	22.	28.	34.	40.	46.
5.	11.	17.	23.	29.	35.	41.	47.
6.	12.	18.	24.	30.	36.	42.	48.

**ARCHITECTURAL REQUIREMENTS**

<b>WALL AND CEILING</b> Wall Material: <input type="text" value="ARGB 1.2m AFF, GB above"/> Finish: <input type="text" value="PT"/> Ceiling Material: <input type="text" value="ACT"/> Finish: <input type="text" value="PF"/>	<b>WALL PROTECTION</b> Type: <input type="text" value="FRP"/> <input checked="" type="checkbox"/> Corner Guards <input type="checkbox"/> Hand Rails <input type="checkbox"/> Bed Bumper / Locator Height: <input type="text" value="1600 mm"/> <input type="checkbox"/> Crash Rails <input checked="" type="checkbox"/> Chair Rail	<b>GLAZING</b> <input checked="" type="checkbox"/> Interior Glazing	<b>FLOORING TYPES</b> Material: <input type="text" value="SDVF"/> Base: <input type="text" value="FCB"/>	<b>ROOM ACCESSORIES</b> <input checked="" type="checkbox"/> Coat Hooks <input type="checkbox"/> Ceiling Lift <input checked="" type="checkbox"/> Magnetic Whiteboard <input type="checkbox"/> Mirror <input type="checkbox"/> Infant Change Table <input type="checkbox"/> Privacy Curtain
--	--	--	---	--

- LEGEND:**
- WALL AND CEILING LEGEND:**
- AC Architectural Ceiling
  - ACT Acoustic Ceiling Tile
  - ACT-C Cleanroom
  - ARGB Abuse-Resistant Gypsum Board
  - GB Gypsum Board
  - IRGB Impact-Resistant Gypsum Board
  - KLCT Kitchen Lay-in Ceiling Tile
  - MMRGB Moisture and Mould-Resistant Gypsum Board
  - SACT Security Acoustic Ceiling Tile
- WALL FINISHES LEGEND:**
- EWC Epoxy Wall Coating
  - HPC High Performance Coating
  - PT Paint
- CEILING FINISHES LEGEND:**
- ECC Epoxy Ceiling Coating
  - HPC High Performance Coating
  - PF Prefinished
  - PT Paint
- WALL PROTECTION LEGEND:**
- ESRP Extruded Semi-Rigid PVCu Panel
  - FRL Fibre Reinforced Laminate
  - FRP Fibreglass Reinforced Plastic
  - PVV Protective Vinyl Wallcovering
  - RHIS Rigid High Impact Sheet
  - WSSP Wetwall Solid Surface Panel
  - WVV Wetroom Vinyl Wallcovering
- FLOOR FINISHES LEGEND:**
- CFS Concrete Floor Sealer
  - EFC Epoxy Floor Coating
  - PFC Polyurethane Floor Coating
  - RAF Rubber Athletic Flooring
  - RSF Rubber Sheet Flooring
  - SCF Seamless Cushioned Flooring
  - SDRF Static-Dissipative Rubber Sheet Flooring
  - SDVF Static-Dissipative Vinyl Sheet Flooring
  - VSF Vinyl Sheet Flooring
  - WSVF Wetroom Safety Vinyl Sheet Flooring
- FLOOR BASE LEGEND:**
- FCB Flash Cove Base
  - RB Rubber Base
  - SCF Seamless Cushioned Flooring

**DOORS**

Types:

Type	Qty	Size (mm)	Material	Finish	Side Lt.	Blinds	Protect.	Privacy Film	Function	Card Reader	Mag Lock	Auto Opener	Hold Open	Hinges	Accessory 1	Accessory 2	Accessory 3	Closer
B	1	1065 x 2135	Shielded	Prefinished			1 Low		Passage					Butt Hinge				Surface

Door Remarks:  Security Grille  Anti-barricade strategy

**MILLWORK AND SPECIALTY CASEWORK**

Storage Requirements:

**UPPER UNITS** U1, U2, U3, U4, U5, U6, U7, U8

**LOWER UNITS** L1, L2, L3, L4, L5, L6, L7, L8, L9

**FULL-HEIGHT CABINETS** C1, C2, C3, C4, C5

**SHELF** S1

**RECEPTION/TRANSACTION COUNTER / CARE TEAM STATION DESK** TC1, TC2

**UTILITY SINK AND COUNTER UNIT** UC1

**FINISHES**

Full-height Cabinet:

Upper Millwork:

Countertop:

Lower Millwork:

Shelf:

Remarks:

Category	Min. Length (mm)	Motorized Adjustable Height	Standing Height	Specialty Casework
3	2700			

**Legend:**  
 Category 0 - None  
 Category 1 - Low (1% - 4%)  
 Category 2 - Med (5% - 9%)  
 Category 3 - High (10% or Greater)

**MECHANICAL REQUIREMENTS**

<b>PLUMBING</b> (Quantity) Hand Hygiene Sink: <input type="text" value="1"/> Lavatory: <input type="text"/> Kitchen Sink: <input type="text"/> Seamless Kitchen Sink: <input type="text"/> Utility / Process Sink: <input type="text"/> Scrub Sink: <input type="text"/> Floor Sink: <input type="text"/> Plumbing Remarks: <input type="text"/>	Other Fixtures: <input type="checkbox"/> Shower <input type="checkbox"/> Eyewash Station <input type="checkbox"/> Tub <input type="checkbox"/> Eyewash/Shower Station <input type="checkbox"/> Ice Maker <input type="checkbox"/> Emergency Shower <input type="checkbox"/> Water Closet <input type="checkbox"/> Flush Rim Sink <input type="checkbox"/> Instantaneous Hot Water <input type="checkbox"/> Floor Drain <input type="checkbox"/> <input type="checkbox"/> Water Bottle Refill Station Other <input type="text"/>	<b>MED / NON-MED GASES</b> (Quantity) Oxygen: <input type="text"/> Medical Air: <input type="text"/> Medical Vacuum: <input type="text"/> Nitrous Oxide: <input type="text"/> CO2: <input type="text"/> AGSS: <input type="text"/> Nitrogen: <input type="text"/> Laboratory Air: <input type="text"/> Laboratory Vacuum: <input type="text"/> Utility Compressed Air: <input type="text"/> Gas Remarks: <input type="text"/>
---	--	---

**Appendix 1B Minimum Room Requirements**

Room Name:

Program Number(s):

1. K1.04	7.	13.	19.	25.	31.	37.	43.
2.	8.	14.	20.	26.	32.	38.	44.
3.	9.	15.	21.	27.	33.	39.	45.
4.	10.	16.	22.	28.	34.	40.	46.
5.	11.	17.	23.	29.	35.	41.	47.
6.	12.	18.	24.	30.	36.	42.	48.

**ARCHITECTURAL REQUIREMENTS**

<b>WALL AND CEILING</b> Wall Material: <input type="text" value="MMRGB"/> Finish: <input type="text" value="PT"/> Ceiling Material: <input type="text" value="ACT"/> Finish: <input type="text" value="PF"/>	<b>WALL PROTECTION</b> Type: <input type="text" value="RHIS"/> <input checked="" type="checkbox"/> Corner Guards <input type="checkbox"/> Hand Rails <input type="checkbox"/> Bed Bumper / Locator Height: <input type="text" value="2480 mm"/> <input type="checkbox"/> Crash Rails <input type="checkbox"/> Chair Rail	<b>GLAZING</b> <input checked="" type="checkbox"/> Interior Glazing	<b>FLOORING TYPES</b> Material: <input type="text" value="VSF"/> Base: <input type="text" value="FCB"/>	<b>ROOM ACCESSORIES</b> <input checked="" type="checkbox"/> Coat Hooks <input type="checkbox"/> Ceiling Lift <input checked="" type="checkbox"/> Magnetic Whiteboard <input type="checkbox"/> Mirror <input type="checkbox"/> Infant Change Table <input type="checkbox"/> Privacy Curtain
--	--	--	--	--

- LEGEND:**
- WALL AND CEILING LEGEND:**
- AC Architectural Ceiling
  - ACT Acoustic Ceiling Tile
  - ACT-C Cleanroom
  - ARGB Abuse-Resistant Gypsum Board
  - GB Gypsum Board
  - IRGB Impact-Resistant Gypsum Board
  - KLCT Kitchen Lay-in Ceiling Tile
  - MMRGB Moisture and Mould-Resistant Gypsum Board
  - SACT Security Acoustic Ceiling Tile
- WALL FINISHES LEGEND:**
- EWC Epoxy Wall Coating
  - HPC High Performance Coating
  - PT Paint
- CEILING FINISHES LEGEND:**
- ECC Epoxy Ceiling Coating
  - HPC High Performance Coating
  - PF Prefinished
  - PT Paint
- WALL PROTECTION LEGEND:**
- ESRP Extruded Semi-Rigid PVCu Panel
  - FRL Fibre Reinforced Laminate
  - FRP Fibreglass Reinforced Plastic
  - PVV Protective Vinyl Wallcovering
  - RHIS Rigid High Impact Sheet
  - WSSP Wetwall Solid Surface Panel
  - WVV Wetroom Vinyl Wallcovering
- FLOOR FINISHES LEGEND:**
- CFS Concrete Floor Sealer
  - EFC Epoxy Floor Coating
  - PFC Polyurethane Floor Coating
  - RAF Rubber Athletic Flooring
  - RSF Rubber Sheet Flooring
  - SCF Seamless Cushioned Flooring
  - SDRF Static-Dissipative Rubber Sheet Flooring
  - SDVF Static-Dissipative Vinyl Sheet Flooring
  - VSF Vinyl Sheet Flooring
  - WSVF Wetroom Safety Vinyl Sheet Flooring
- FLOOR BASE LEGEND:**
- FCB Flash Cove Base
  - RB Rubber Base
  - SCF Seamless Cushioned Flooring

**DOORS**

Types:

Type	Qty	Size (mm)	Material	Finish	Side Lt.	Blinds	Protect.	Privacy Film	Function	Card Reader	Mag Lock	Auto Opener	Hold Open	Hinges	Accessory 1	Accessory 2	Accessory 3	Closer
A2	1	1830 x 2440	Hollow Metal	Paint	<input type="checkbox"/>	<input type="checkbox"/>		<input type="checkbox"/>	Storeroom	<input checked="" type="checkbox"/>	<input type="checkbox"/>	<input type="checkbox"/>	<input type="checkbox"/>	Butt Hinge	Astragal	Flush Bolt		Surface

**Door Remarks:**

Security Grille  
 Anti-barricade strategy

**MILLWORK AND SPECIALTY CASEWORK**

Storage Requirements:

**UPPER UNITS:** U1, U2, U3, U4, U5, U6, U7, U8

**LOWER UNITS:** L1, L2, L3, L4, L5, L6, L7, L8, L9, L10, L11, L12

**RECEPTION/TRANSACTION COUNTER / CARE TEAM STATION DESK:** TC1, TC2

**UTILITY SINK AND COUNTER UNIT:** UC1

**SHELF:** S1

**FULL-HEIGHT CABINETS:** C1, C2, C3, C4, C5

**Legend:**

Category	Min. Length (mm)	Motorized Adjustable Height	Standing Height	Specialty Casework
1	1800	<input type="checkbox"/>	<input type="checkbox"/>	<input type="checkbox"/>

**FINISHES**

Full-height Cabinet:   
 Upper Millwork:   
 Countertop:   
 Lower Millwork:   
 Shelf:

**Remarks:**

**MECHANICAL REQUIREMENTS**

**PLUMBING**

Hand Hygiene Sink:	Lavatory:	Kitchen Sink:	Seamless Kitchen Sink:	Utility / Process Sink:	Scrub Sink:	Floor Sink:
				1		

Plumbing Remarks:

**Other Fixtures:**

- Shower
- Tub
- Ice Maker
- Water Closet
- Instantaneous Hot Water
- Eyewash Station
- Eyewash/Shower Station
- Emergency Shower
- Flush Rim Sink
- Floor Drain
- Water Bottle Refill Station

Other:

**MED / NON-MED GASES**

Oxygen:	Medical Air:	Medical Vacuum:	Nitrous Oxide:	CO2:	AGSS:	Nitrogen:	Laboratory Air:	Laboratory Vacuum:	Utility Compressed Air:
									1

Gas Remarks:



# Appendix 1B Minimum Room Requirements

Room Name:

Program Number(s):

1. K3.07	7.	13.	19.	25.	31.	37.	43.
2.	8.	14.	20.	26.	32.	38.	44.
3.	9.	15.	21.	27.	33.	39.	45.
4.	10.	16.	22.	28.	34.	40.	46.
5.	11.	17.	23.	29.	35.	41.	47.
6.	12.	18.	24.	30.	36.	42.	48.

## ARCHITECTURAL REQUIREMENTS

<b>WALL AND CEILING</b> Wall Material: <input type="text" value="ARGB 1.2m AFF, GB above"/> Finish: <input type="text" value="PT"/> Ceiling Material: <input type="text" value="ACT"/> Finish: <input type="text" value="PF"/>	<b>WALL PROTECTION</b> Type: <input type="text" value="PVW"/> <input checked="" type="checkbox"/> Corner Guards <input type="checkbox"/> Hand Rails <input type="checkbox"/> Bed Bumper / Locator Height: <input type="text" value="2185 mm"/> <input type="checkbox"/> Crash Rails <input type="checkbox"/> Chair Rail	<b>GLAZING</b> <input type="checkbox"/> Interior Glazing	<b>FLOORING TYPES</b> Material: <input type="text" value="WSVF"/> Base: <input type="text" value="FCB"/>	<b>ROOM ACCESSORIES</b> <input checked="" type="checkbox"/> Coat Hooks <input checked="" type="checkbox"/> Ceiling Lift <input checked="" type="checkbox"/> Magnetic Whiteboard <input checked="" type="checkbox"/> Mirror <input type="checkbox"/> Infant Change Table <input checked="" type="checkbox"/> Privacy Curtain
--	---	---	---	---

- LEGEND:**
- WALL AND CEILING LEGEND:**
- AC Architectural Ceiling
  - ACT Acoustic Ceiling Tile
  - ACT-C Cleanroom
  - ARGB Abuse-Resistant Gypsum Board
  - GB Gypsum Board
  - IRGB Impact-Resistant Gypsum Board
  - KLCT Kitchen Lay-in Ceiling Tile
  - MMRGB Moisture and Mould-Resistant Gypsum Board
  - SACT Security Acoustic Ceiling Tile
- WALL FINISHES LEGEND:**
- EWC Epoxy Wall Coating
  - HPC High Performance Coating
  - PT Paint
- CEILING FINISHES LEGEND:**
- ECC Epoxy Ceiling Coating
  - HPC High Performance Coating
  - PF Prefinished
  - PT Paint
- WALL PROTECTION LEGEND:**
- ESRP Extruded Semi-Rigid PVCu Panel
  - FRL Fibre Reinforced Laminate
  - FRP Fibreglass Reinforced Plastic
  - PVW Protective Vinyl Wallcovering
  - RHIS Rigid High Impact Sheet
  - WSSP Wetwall Solid Surface Panel
  - WVV Wetroom Vinyl Wallcovering
- FLOOR FINISHES LEGEND:**
- CFS Concrete Floor Sealer
  - EFC Epoxy Floor Coating
  - PFC Polyurethane Floor Coating
  - RAF Rubber Athletic Flooring
  - RSF Rubber Sheet Flooring
  - SCF Seamless Cushioned Flooring
  - SDRF Static-Dissipative Rubber Sheet Flooring
  - SDVF Static-Dissipative Vinyl Sheet Flooring
  - VSF Vinyl Sheet Flooring
  - WSVF Wetroom Safety Vinyl Sheet Flooring
- FLOOR BASE LEGEND:**
- FCB Flash Cove Base
  - RB Rubber Base
  - SCF Seamless Cushioned Flooring

**DOORS**

Types:

Note: for Type F doors, the door panels will be approximately 465/1065 unless otherwise required by the Authority

Type	Qty	Size (mm)	Material	Finish	Side Lt.	Blinds	Protect.	Privacy Film	Function	Card Reader	Mag Lock	Auto Opener	Hold Open	Hinges	Accessory 1	Accessory 2	Accessory 3	Closer
F	1	1530 x 2135	Solid Core	FRL	<input type="checkbox"/>	<input type="checkbox"/>	2 High	<input type="checkbox"/>	Passage	<input type="checkbox"/>	<input type="checkbox"/>	<input type="checkbox"/>	<input checked="" type="checkbox"/>	Butt Hinge	Astragal	Flush Bolt		Concealed

**FINISHES**

Full-height Cabinet:	Plastic Laminate
Upper Millwork:	Plastic Laminate
Countertop:	Solid Surfacing
Lower Millwork:	Plastic Laminate
Shelf:	

Remarks:

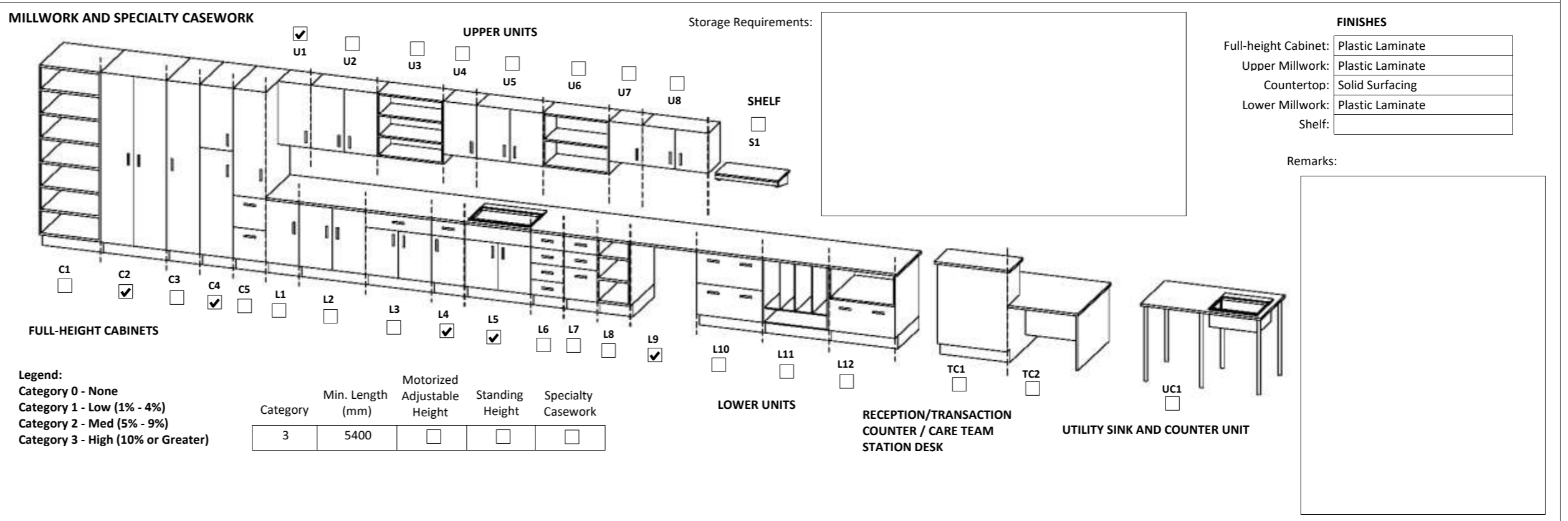

## MECHANICAL REQUIREMENTS

**PLUMBING**

(Quantity)	Hand Hygiene Sink:	Lavatory:	Kitchen Sink:	Seamless Kitchen Sink:	Utility / Process Sink:	Scrub Sink:	Floor Sink:
1					1		

Plumbing Remarks:

**Other Fixtures:**

- Shower
- Tub
- Ice Maker
- Water Closet
- Instantaneous Hot Water
- Eyewash Station
- Eyewash/Shower Station
- Emergency Shower
- Flush Rim Sink
- Floor Drain
- Water Bottle Refill Station

Other:

**MED / NON-MED GASES**

(Quantity)	Oxygen:	Medical Air:	Medical Vacuum:	Nitrous Oxide:	CO2:	AGSS:	Nitrogen:	Laboratory Air:	Laboratory Vacuum:	Utility Compressed Air:
1		1								

Gas Remarks:

**Appendix 1B Minimum Room Requirements**

Room Name:

Program Number(s):

1. K3.08	7.	13.	19.	25.	31.	37.	43.
2.	8.	14.	20.	26.	32.	38.	44.
3.	9.	15.	21.	27.	33.	39.	45.
4.	10.	16.	22.	28.	34.	40.	46.
5.	11.	17.	23.	29.	35.	41.	47.
6.	12.	18.	24.	30.	36.	42.	48.

**ARCHITECTURAL REQUIREMENTS**

<b>WALL AND CEILING</b> Wall Material: <input type="text" value="ARGB 1.2m AFF, GB above"/> Finish: <input type="text" value="PT"/> Ceiling Material: <input type="text" value="ACT"/> Finish: <input type="text" value="PF"/>	<b>WALL PROTECTION</b> Type: <input type="text" value="PVW"/> <input checked="" type="checkbox"/> Corner Guards <input type="checkbox"/> Hand Rails <input type="checkbox"/> Bed Bumper / Locator Height: <input type="text" value="1350 mm"/> <input type="checkbox"/> Crash Rails <input type="checkbox"/> Chair Rail	<b>GLAZING</b> <input type="checkbox"/> Interior Glazing	<b>FLOORING TYPES</b> Material: <input type="text" value="SDVF"/> Base: <input type="text" value="FCB"/>	<b>ROOM ACCESSORIES</b> <input checked="" type="checkbox"/> Coat Hooks <input checked="" type="checkbox"/> Ceiling Lift <input checked="" type="checkbox"/> Magnetic Whiteboard <input checked="" type="checkbox"/> Mirror <input type="checkbox"/> Infant Change Table <input checked="" type="checkbox"/> Privacy Curtain
--	---	---	---	---

- LEGEND:**
- WALL AND CEILING LEGEND:**
- AC Architectural Ceiling
  - ACT Acoustic Ceiling Tile
  - ACT-C Cleanroom
  - ARGB Abuse-Resistant Gypsum Board
  - GB Gypsum Board
  - IRGB Impact-Resistant Gypsum Board
  - KLCT Kitchen Lay-in Ceiling Tile
  - MMRGB Moisture and Mould-Resistant Gypsum Board
  - SACT Security Acoustic Ceiling Tile
- WALL FINISHES LEGEND:**
- EWC Epoxy Wall Coating
  - HPC High Performance Coating
  - PT Paint
- CEILING FINISHES LEGEND:**
- ECC Epoxy Ceiling Coating
  - HPC High Performance Coating
  - PF Prefinished
  - PT Paint
- WALL PROTECTION LEGEND:**
- ESRP Extruded Semi-Rigid PVCu Panel
  - FRL Fibre Reinforced Laminate
  - FRP Fibreglass Reinforced Plastic
  - PVW Protective Vinyl Wallcovering
  - RHIS Rigid High Impact Sheet
  - WSSP Wetwall Solid Surface Panel
  - WVV Wetroom Vinyl Wallcovering
- FLOOR FINISHES LEGEND:**
- CFS Concrete Floor Sealer
  - EFC Epoxy Floor Coating
  - PFC Polyurethane Floor Coating
  - RAF Rubber Athletic Flooring
  - RSF Rubber Sheet Flooring
  - SCF Seamless Cushioned Flooring
  - SDRF Static-Dissipative Rubber Sheet Flooring
  - SDVF Static-Dissipative Vinyl Sheet Flooring
  - VSF Vinyl Sheet Flooring
  - WSVF Wetroom Safety Vinyl Sheet Flooring
- FLOOR BASE LEGEND:**
- FCB Flash Cove Base
  - RB Rubber Base
  - SCF Seamless Cushioned Flooring

**DOORS**

Types:

Note: for Type F doors, the door panels will be approximately 465/1065 unless otherwise required by the Authority

Door Remarks:  Lockable door from inside.  Security Grille  Anti-barricade strategy

Type	Qty	Size (mm)	Material	Finish	Side Lt	Blinds	Protect	Privacy Film	Function	Card Reader	Mag Lock	Auto Opener	Hold Open	Hinges	Accessory 1	Accessory 2	Accessory 3	Closer
F	1	1530 x 2135	Shielded	Prefinished	<input type="checkbox"/>	<input type="checkbox"/>	2 High	<input type="checkbox"/>	Storeroom	<input checked="" type="checkbox"/>	<input type="checkbox"/>	<input type="checkbox"/>	<input checked="" type="checkbox"/>	Butt Hinge	Astragal	Flush Bolt		Concealed

**MILLWORK AND SPECIALTY CASEWORK**

Storage Requirements:

**UPPER UNITS:** U1, U2, U3, U4, U5, U6, U7, U8

**LOWER UNITS:** L1, L2, L3, L4, L5, L6, L7, L8, L9, L10, L11, L12

**RECEPTION/TRANSACTION COUNTER / CARE TEAM STATION DESK:** TC1, TC2

**UTILITY SINK AND COUNTER UNIT:** UC1

**SHELF:** S1

**FULL-HEIGHT CABINETS:** C1, C2, C3, C4, C5

**Legend:**

Category	Min. Length (mm)	Motorized Adjustable Height	Standing Height	Specialty Casework
1	2100	<input checked="" type="checkbox"/>	<input type="checkbox"/>	<input type="checkbox"/>

**FINISHES**

- Full-height Cabinet:
- Upper Millwork:
- Countertop:
- Lower Millwork:
- Shelf:

Remarks: Refer to Schedule 1: Trapeze and Hoist Bar for ceiling equipment requirements

**MECHANICAL REQUIREMENTS**

<b>PLUMBING</b> (Quantity) Hand Hygiene Sink: <input type="text" value="1"/> Lavatory: <input type="text"/> Kitchen Sink: <input type="text"/> Seamless Kitchen Sink: <input type="text"/> Utility / Process Sink: <input type="text" value="1"/> Scrub Sink: <input type="text"/> Floor Sink: <input type="text"/> Plumbing Remarks: <input type="text"/>	Other Fixtures: <input type="checkbox"/> Shower <input type="checkbox"/> Eyewash Station <input type="checkbox"/> Tub <input type="checkbox"/> Eyewash/Shower Station <input type="checkbox"/> Ice Maker <input type="checkbox"/> Emergency Shower <input type="checkbox"/> Water Closet <input type="checkbox"/> Flush Rim Sink <input type="checkbox"/> Instantaneous Hot Water <input type="checkbox"/> Floor Drain <input type="checkbox"/> <input type="checkbox"/> Water Bottle Refill Station Other: <input type="text"/>	<b>MED / NON-MED GASES</b> (Quantity) Oxygen: <input type="text" value="1"/> Medical Air: <input type="text" value="1"/> Medical Vacuum: <input type="text" value="1"/> Nitrous Oxide: <input type="text"/> CO2: <input type="text"/> AGSS: <input type="text"/> Nitrogen: <input type="text"/> Laboratory Air: <input type="text"/> Laboratory Vacuum: <input type="text"/> Utility Compressed Air: <input type="text"/> Gas Remarks: <input type="text"/>
---	---	--

**Appendix 1B Minimum Room Requirements**

Room Name:

Program Number(s):

1. K4.12	7.	13.	19.	25.	31.	37.	43.
2.	8.	14.	20.	26.	32.	38.	44.
3.	9.	15.	21.	27.	33.	39.	45.
4.	10.	16.	22.	28.	34.	40.	46.
5.	11.	17.	23.	29.	35.	41.	47.
6.	12.	18.	24.	30.	36.	42.	48.

**ARCHITECTURAL REQUIREMENTS**

<b>WALL AND CEILING</b> Wall Material: <input type="text" value="ARGB 1.2m AFF, GB above"/> Finish: <input type="text" value="PT"/> Ceiling Material: <input type="text" value="ACT"/> Finish: <input type="text" value="PF"/>	<b>WALL PROTECTION</b> Type: <input type="text" value="PVW"/> <input checked="" type="checkbox"/> Corner Guards <input type="checkbox"/> Hand Rails <input type="checkbox"/> Bed Bumper / Locator Height: <input type="text" value="1350 mm"/> <input type="checkbox"/> Crash Rails <input type="checkbox"/> Chair Rail	<b>GLAZING</b> <input checked="" type="checkbox"/> Interior Glazing	<b>FLOORING TYPES</b> Material: <input type="text" value="SDVF"/> Base: <input type="text" value="FCB"/>	<b>ROOM ACCESSORIES</b> <input type="checkbox"/> Coat Hooks <input type="checkbox"/> Ceiling Lift <input type="checkbox"/> Magnetic Whiteboard <input type="checkbox"/> Mirror <input type="checkbox"/> Infant Change Table <input type="checkbox"/> Privacy Curtain
--	---	--	---	--

- LEGEND:**
- WALL AND CEILING LEGEND:**
- AC Architectural Ceiling
  - ACT Acoustic Ceiling Tile
  - ACT-C Cleanroom
  - ARGB Abuse-Resistant Gypsum Board
  - GB Gypsum Board
  - IRGB Impact-Resistant Gypsum Board
  - KLCT Kitchen Lay-in Ceiling Tile
  - MMRGB Moisture and Mould-Resistant Gypsum Board
  - SACT Security Acoustic Ceiling Tile
- WALL FINISHES LEGEND:**
- EWC Epoxy Wall Coating
  - HPC High Performance Coating
  - PT Paint
- CEILING FINISHES LEGEND:**
- ECC Epoxy Ceiling Coating
  - HPC High Performance Coating
  - PF Prefinished
  - PT Paint
- WALL PROTECTION LEGEND:**
- ESRP Extruded Semi-Rigid PVCu Panel
  - FRL Fibre Reinforced Laminate
  - FRP Fibreglass Reinforced Plastic
  - PVW Protective Vinyl Wallcovering
  - RHIS Rigid High Impact Sheet
  - WSSP Wetwall Solid Surface Panel
  - WVV Wetroom Vinyl Wallcovering
- FLOOR FINISHES LEGEND:**
- CFS Concrete Floor Sealer
  - EFC Epoxy Floor Coating
  - PFC Polyurethane Floor Coating
  - RAF Rubber Athletic Flooring
  - RSF Rubber Sheet Flooring
  - SCF Seamless Cushioned Flooring
  - SDRF Static-Dissipative Rubber Sheet Flooring
  - SDVF Static-Dissipative Vinyl Sheet Flooring
  - VSF Vinyl Sheet Flooring
  - WSVF Wetroom Safety Vinyl Sheet Flooring
- FLOOR BASE LEGEND:**
- FCB Flash Cove Base
  - RB Rubber Base
  - SCF Seamless Cushioned Flooring

**DOORS**

Types:

Type	Qty	Size (mm)	Material	Finish	Side Lt.	Blinds	Protect.	Privacy Film	Function	Card Reader	Mag Lock	Auto Opener	Hold Open	Hinges	Accessory 1	Accessory 2	Accessory 3	Closer
A	1	1220 x 2135	Shielded	Prefinished	<input type="checkbox"/>	<input type="checkbox"/>	2 High	<input type="checkbox"/>	Office	<input type="checkbox"/>	<input type="checkbox"/>	<input type="checkbox"/>	<input checked="" type="checkbox"/>	Butt Hinge				Concealed

Door Remarks:  Security Grille  Anti-barricade strategy

RF shielded MRI door, refer to Section 13 49 23 – Radio Frequency Shielding Systems

**MILLWORK AND SPECIALTY CASEWORK**

**UPPER UNITS** (U1-U8) **LOWER UNITS** (L1-L12) **RECEPTION/TRANSACTION COUNTER / CARE TEAM STATION DESK** (TC1-TC2) **UTILITY SINK AND COUNTER UNIT** (UC1)

Storage Requirements:

**FINISHES**

Full-height Cabinet:	<input type="text" value="Plastic Laminate"/>
Upper Millwork:	<input type="text" value="Plastic Laminate"/>
Countertop:	<input type="text" value="Plastic Laminate"/>
Lower Millwork:	<input type="text" value="Plastic Laminate"/>
Shelf:	<input type="text"/>

Remarks:

**Legend:**

Category	Min. Length (mm)	Motorized Adjustable Height	Standing Height	Specialty Casework
1	3000	<input type="checkbox"/>	<input type="checkbox"/>	<input type="checkbox"/>

**MECHANICAL REQUIREMENTS**

<b>PLUMBING</b> (Quantity) Hand Hygiene Sink: <input type="text"/> Lavatory: <input type="text"/> Kitchen Sink: <input type="text"/> Seamless Kitchen Sink: <input type="text"/> Utility / Process Sink: <input type="text"/> Scrub Sink: <input type="text"/> Floor Sink: <input type="text"/> Plumbing Remarks: <input type="text"/>	Other Fixtures: <input type="checkbox"/> Shower <input type="checkbox"/> Eyewash Station <input type="checkbox"/> Tub <input type="checkbox"/> Eyewash/Shower Station <input type="checkbox"/> Ice Maker <input type="checkbox"/> Emergency Shower <input type="checkbox"/> Water Closet <input type="checkbox"/> Flush Rim Sink <input type="checkbox"/> Instantaneous Hot Water <input type="checkbox"/> Floor Drain <input type="checkbox"/> <input type="checkbox"/> Water Bottle Refill Station Other <input type="text"/>	<b>MED / NON-MED GASES</b> (Quantity) Oxygen: <input type="text" value="1"/> Medical Air: <input type="text" value="1"/> Medical Vacuum: <input type="text" value="1"/> Nitrous Oxide: <input type="text"/> CO2: <input type="text"/> AGSS: <input type="text"/> Nitrogen: <input type="text"/> Laboratory Air: <input type="text"/> Laboratory Vacuum: <input type="text"/> Utility Compressed Air: <input type="text"/> Gas Remarks: <input type="text"/>
---	--	--



**Appendix 1B Minimum Room Requirements**

Room Name:

Program Number(s):

1.	K1.05	7.		13.		19.		25.		31.		37.		43.
2.		8.		14.		20.		26.		32.		38.		44.
3.		9.		15.		21.		27.		33.		39.		45.
4.		10.		16.		22.		28.		34.		40.		46.
5.		11.		17.		23.		29.		35.		41.		47.
6.		12.		18.		24.		30.		36.		42.		48.

**ARCHITECTURAL REQUIREMENTS**

<b>WALL AND CEILING</b> Wall Material: <input type="text" value="MMRGB"/> Finish: <input type="text" value="PT"/> Ceiling Material: <input type="text" value="ACT"/> Finish: <input type="text" value="PF"/>		<b>WALL PROTECTION</b> Type: <input type="text" value="RHIS"/> <input checked="" type="checkbox"/> Corner Guards <input type="checkbox"/> Hand Rails <input type="checkbox"/> Bed Bumper / Locator Height: <input type="text" value="2795 mm"/> <input type="checkbox"/> Crash Rails <input type="checkbox"/> Chair Rail			<b>GLAZING</b> <input type="checkbox"/> Interior Glazing		<b>FLOORING TYPES</b> Material: <input type="text" value="PFC"/> Base: <input type="text" value="FCB"/>		<b>ROOM ACCESSORIES</b> <input checked="" type="checkbox"/> Coat Hooks <input type="checkbox"/> Ceiling Lift <input checked="" type="checkbox"/> Magnetic Whiteboard <input type="checkbox"/> Mirror <input type="checkbox"/> Infant Change Table <input type="checkbox"/> Privacy Curtain		
--	--	--	--	--	---	--	--	--	--	--	--

- LEGEND:**
- WALL AND CEILING LEGEND:**
- AC Architectural Ceiling
  - ACT Acoustic Ceiling Tile
  - ACT-C Cleanroom
  - ARGB Abuse-Resistant Gypsum Board
  - GB Gypsum Board
  - IRGB Impact-Resistant Gypsum Board
  - KLCT Kitchen Lay-in Ceiling Tile
  - MMRGB Moisture and Mould-Resistant Gypsum Board
  - SACT Security Acoustic Ceiling Tile
- WALL FINISHES LEGEND:**
- EWC Epoxy Wall Coating
  - HPC High Performance Coating
  - PT Paint
- CEILING FINISHES LEGEND:**
- ECC Epoxy Ceiling Coating
  - HPC High Performance Coating
  - PF Prefinished
  - PT Paint
- WALL PROTECTION LEGEND:**
- ESRP Extruded Semi-Rigid PVCu Panel
  - FRL Fibre Reinforced Laminate
  - FRP Fibreglass Reinforced Plastic
  - PVV Protective Vinyl Wallcovering
  - RHIS Rigid High Impact Sheet
  - WSSP Wetwall Solid Surface Panel
  - WVV Wetroom Vinyl Wallcovering
- FLOOR FINISHES LEGEND:**
- CFS Concrete Floor Sealer
  - EFC Epoxy Floor Coating
  - PFC Polyurethane Floor Coating
  - RAF Rubber Athletic Flooring
  - RSF Rubber Sheet Flooring
  - SCF Seamless Cushioned Flooring
  - SDRF Static-Dissipative Rubber Sheet Flooring
  - SDVF Static-Dissipative Vinyl Sheet Flooring
  - VSF Vinyl Sheet Flooring
  - WSVF Wetroom Safety Vinyl Sheet Flooring
- FLOOR BASE LEGEND:**
- FCB Flash Cove Base
  - RB Rubber Base
  - SCF Seamless Cushioned Flooring

**DOORS**

Types:

Type:Qty:	Size (mm):	Material:	Finish:	Side Lt:	Blinds:	Protect.:	Privacy Film:	Function:	Card Reader:	Mag Lock:	Auto Opener:	Hold Open:	Hinges:	Accessory 1:	Accessory 2:	Accessory 3:	Closer:
A2 2	2440 x 2745	Hollow Metal	Paint	<input type="checkbox"/>	<input type="checkbox"/>		<input type="checkbox"/>	Storeroom	<input checked="" type="checkbox"/>	<input type="checkbox"/>	<input type="checkbox"/>	<input type="checkbox"/>	Butt Hinge	Astragal	Flush Bolt		Surface

Door Remarks:  Security Grille  Anti-barricade strategy

**MILLWORK AND SPECIALTY CASEWORK**

**UPPER UNITS** U1  U2  U3  U4  U5  U6  U7  U8

**LOWER UNITS** L1  L2  L3  L4  L5  L6  L7  L8  L9  L10  L11  L12

**FULL-HEIGHT CABINETS** C1  C2  C3  C4  C5

**RECEPTION/TRANSACTION COUNTER / CARE TEAM STATION DESK** TC1  TC2

**UTILITY SINK AND COUNTER UNIT** UC1

**SHelf** S1

Storage Requirements:

**FINISHES**

Full-height Cabinet:	<input type="text" value="Plastic Laminate"/>
Upper Millwork:	<input type="text" value="Plastic Laminate"/>
Countertop:	<input type="text" value="Hardwood"/>
Lower Millwork:	<input type="text" value="Plastic Laminate"/>
Shelf:	<input type="text"/>

Remarks:

**Legend:**

Category	Min. Length (mm)	Motorized Adjustable Height	Standing Height	Specialty Casework
1	9000	<input type="checkbox"/>	<input type="checkbox"/>	<input type="checkbox"/>

Category 0 - None  
 Category 1 - Low (1% - 4%)  
 Category 2 - Med (5% - 9%)  
 Category 3 - High (10% or Greater)

**MECHANICAL REQUIREMENTS**

<b>PLUMBING</b> (Quantity) Hygiene Sink: <input type="text" value="1"/> Lavatory: <input type="text"/> Kitchen Sink: <input type="text"/> Kitchen Sink: <input type="text"/> Utility / Process Sink: <input type="text" value="1"/> Scrub Sink: <input type="text"/> Floor Sink: <input type="text"/>							Other Fixtures: <input type="checkbox"/> Shower <input type="checkbox"/> Tub <input type="checkbox"/> Ice Maker <input type="checkbox"/> Water Closet <input type="checkbox"/> Instantaneous Hot Water				<input checked="" type="checkbox"/> Eyewash Station <input type="checkbox"/> Eyewash/Shower Station <input type="checkbox"/> Emergency Shower <input type="checkbox"/> Flush Rim Sink <input checked="" type="checkbox"/> Floor Drain <input type="checkbox"/> Water Bottle Refill Station				<b>MED / NON-MED GASES</b> (Quantity) Oxygen: <input type="text"/> Medical Air: <input type="text"/> Medical Vacuum: <input type="text"/> Nitrous Oxide: <input type="text"/> CO2: <input type="text"/> AGSS: <input type="text"/> Nitrogen: <input type="text"/> Laboratory Air: <input type="text"/> Laboratory Vacuum: <input type="text"/> Utility Compressed Air: <input type="text" value="4"/>				
Plumbing Remarks: <input type="text" value="Eyewash/shower station the Service Elevator Lobby of each floor"/>							Gas Remarks: <input type="text"/>												

**Appendix 1B Minimum Room Requirements**

Room Name:

Program Number(s):

1.	K3.12	7.		13.		19.		25.		31.		37.		43.
2.		8.		14.		20.		26.		32.		38.		44.
3.		9.		15.		21.		27.		33.		39.		45.
4.		10.		16.		22.		28.		34.		40.		46.
5.		11.		17.		23.		29.		35.		41.		47.
6.		12.		18.		24.		30.		36.		42.		48.

**ARCHITECTURAL REQUIREMENTS**

<b>WALL AND CEILING</b> Wall Material: <input type="text" value="ARGB 1.2m AFF, GB above"/> Finish: <input type="text" value="PT"/> Ceiling Material: <input type="text" value="ACT"/> Finish: <input type="text" value="PF"/>	<b>WALL PROTECTION</b> Type: <input type="text" value="PVW"/> <input checked="" type="checkbox"/> Corner Guards <input type="checkbox"/> Hand Rails <input type="checkbox"/> Bed Bumper / Locator Height: <input type="text" value="1350 mm"/> <input type="checkbox"/> Crash Rails <input type="checkbox"/> Chair Rail	<b>GLAZING</b> <input type="checkbox"/> Interior Glazing	<b>FLOORING TYPES</b> Material: <input type="text" value="VSF"/> Base: <input type="text" value="FCB"/>	<b>ROOM ACCESSORIES</b> <input type="checkbox"/> Coat Hooks <input type="checkbox"/> Ceiling Lift <input type="checkbox"/> Magnetic Whiteboard <input type="checkbox"/> Mirror <input type="checkbox"/> Infant Change Table <input type="checkbox"/> Privacy Curtain
--	---	---	--	--

- LEGEND:**
- WALL AND CEILING LEGEND:**
- AC Architectural Ceiling
  - ACT Acoustic Ceiling Tile
  - ACT-C Cleanroom
  - ARGB Abuse-Resistant Gypsum Board
  - GB Gypsum Board
  - IRGB Impact-Resistant Gypsum Board
  - KLCT Kitchen Lay-in Ceiling Tile
  - MMRGB Moisture and Mould-Resistant Gypsum Board
  - SACT Security Acoustic Ceiling Tile
- WALL FINISHES LEGEND:**
- EWC Epoxy Wall Coating
  - HPC High Performance Coating
  - PT Paint
- CEILING FINISHES LEGEND:**
- ECC Epoxy Ceiling Coating
  - HPC High Performance Coating
  - PF Prefinished
  - PT Paint
- WALL PROTECTION LEGEND:**
- ESRP Extruded Semi-Rigid PVCu Panel
  - FRL Fibre Reinforced Laminate
  - FRP Fibreglass Reinforced Plastic
  - PVW Protective Vinyl Wallcovering
  - RHIS Rigid High Impact Sheet
  - WSSP Wetwall Solid Surface Panel
  - WVV Wetroom Vinyl Wallcovering
- FLOOR FINISHES LEGEND:**
- CFS Concrete Floor Sealer
  - EFC Epoxy Floor Coating
  - PFC Polyurethane Floor Coating
  - RAF Rubber Athletic Flooring
  - RSF Rubber Sheet Flooring
  - SCF Seamless Cushioned Flooring
  - SDRF Static-Dissipative Rubber Sheet Flooring
  - SDVF Static-Dissipative Vinyl Sheet Flooring
  - VSF Vinyl Sheet Flooring
  - WSVF Wetroom Safety Vinyl Sheet Flooring
- FLOOR BASE LEGEND:**
- FCB Flash Cove Base
  - RB Rubber Base
  - SCF Seamless Cushioned Flooring

**DOORS**

Types:

Type	Qty	Size (mm)	Material	Finish	Side Lt.	Blinds	Protect.	Privacy Film	Function	Card Reader	Mag Lock	Auto Opener	Hold Open	Hinges	Accessory 1	Accessory 2	Accessory 3	Closer
C	1	1830 x 2135	Solid Core	FRL	<input type="checkbox"/>	<input type="checkbox"/>	2 High	<input checked="" type="checkbox"/>	Storeroom	<input checked="" type="checkbox"/>	<input type="checkbox"/>	<input type="checkbox"/>	<input type="checkbox"/>	Cont. Swing Clear				Surface

**Door Remarks:**

Security Grille  
 Anti-barricade strategy

**MILLWORK AND SPECIALTY CASEWORK**

Storage Requirements:

**UPPER UNITS**

- U1
- U2
- U3
- U4
- U5
- U6
- U7
- U8

**SHELF**

- S1

**LOWER UNITS**

- L1
- L2
- L3
- L4
- L5
- L6
- L7
- L8
- L9
- L10
- L11
- L12

**RECEPTION/TRANSACTION COUNTER / CARE TEAM STATION DESK**

- TC1
- TC2

**UTILITY SINK AND COUNTER UNIT**

- UC1

**FULL-HEIGHT CABINETS**

- C1
- C2
- C3
- C4
- C5

**Legend:**

Category	Min. Length (mm)	Motorized Adjustable Height	Standing Height	Specialty Casework
3	5100	<input type="checkbox"/>	<input type="checkbox"/>	<input type="checkbox"/>

**FINISHES**

- Full-height Cabinet:
- Upper Millwork:
- Countertop:
- Lower Millwork:
- Shelf:

**Remarks:**

**MECHANICAL REQUIREMENTS**

<b>PLUMBING</b> (Quantity) Hand Hygiene Sink: <input type="text"/> Lavatory: <input type="text"/> Kitchen Sink: <input type="text"/> Seamless Kitchen Sink: <input type="text"/> Utility / Process Sink: <input type="text"/> Scrub Sink: <input type="text"/> Floor Sink: <input type="text"/> Plumbing Remarks: <input type="text"/>	Other Fixtures: <input type="checkbox"/> Shower <input type="checkbox"/> Tub <input type="checkbox"/> Ice Maker <input type="checkbox"/> Water Closet <input type="checkbox"/> Instantaneous Hot Water <input type="checkbox"/> Eyewash Station <input type="checkbox"/> Eyewash/Shower Station <input type="checkbox"/> Emergency Shower <input type="checkbox"/> Flush Rim Sink <input type="checkbox"/> Floor Drain <input type="checkbox"/> Water Bottle Refill Station Other: <input type="text"/>	<b>MED / NON-MED GASES</b> (Quantity) Oxygen: <input type="text"/> Medical Air: <input type="text"/> Medical Vacuum: <input type="text"/> Nitrous Oxide: <input type="text"/> CO2: <input type="text"/> AGSS: <input type="text"/> Nitrogen: <input type="text"/> Laboratory Air: <input type="text"/> Laboratory Vacuum: <input type="text"/> Utility Compressed Air: <input type="text"/> Gas Remarks: <input type="text"/>
---	---	---

**Appendix 1B Minimum Room Requirements**

Room Name:

Program Number(s):

1.	K3.13	7.		13.		19.		25.		31.		37.		43.
2.		8.		14.		20.		26.		32.		38.		44.
3.		9.		15.		21.		27.		33.		39.		45.
4.		10.		16.		22.		28.		34.		40.		46.
5.		11.		17.		23.		29.		35.		41.		47.
6.		12.		18.		24.		30.		36.		42.		48.

**ARCHITECTURAL REQUIREMENTS**

<b>WALL AND CEILING</b> Wall Material: <input type="text" value="ARGB 1.2m AFF, GB above"/> Finish: <input type="text" value="PT"/> Ceiling Material: <input type="text" value="ACT"/> Finish: <input type="text" value="PF"/>		<b>WALL PROTECTION</b> Type: <input type="text" value="PVW"/> <input checked="" type="checkbox"/> Corner Guards <input type="checkbox"/> Hand Rails <input type="checkbox"/> Bed Bumper / Locator Height: <input type="text" value="1350 mm"/> <input type="checkbox"/> Crash Rails <input type="checkbox"/> Chair Rail			<b>GLAZING</b> <input type="checkbox"/> Interior Glazing		<b>FLOORING TYPES</b> Material: <input type="text" value="VSF"/> Base: <input type="text" value="FCB"/>		<b>ROOM ACCESSORIES</b> <input type="checkbox"/> Coat Hooks <input type="checkbox"/> Ceiling Lift <input type="checkbox"/> Magnetic Whiteboard <input type="checkbox"/> Mirror <input type="checkbox"/> Infant Change Table <input type="checkbox"/> Privacy Curtain		
--	--	---	--	--	---	--	--	--	--	--	--

- LEGEND:**
- WALL AND CEILING LEGEND:**
- AC Architectural Ceiling
  - ACT Acoustic Ceiling Tile
  - ACT-C Cleanroom
  - ARGB Abuse-Resistant Gypsum Board
  - GB Gypsum Board
  - IRGB Impact-Resistant Gypsum Board
  - KLCT Kitchen Lay-in Ceiling Tile
  - MMRGB Moisture and Mould-Resistant Gypsum Board
  - SACT Security Acoustic Ceiling Tile
- WALL FINISHES LEGEND:**
- EWC Epoxy Wall Coating
  - HPC High Performance Coating
  - PT Paint
- CEILING FINISHES LEGEND:**
- ECC Epoxy Ceiling Coating
  - HPC High Performance Coating
  - PF Prefinished
  - PT Paint
- WALL PROTECTION LEGEND:**
- ESRP Extruded Semi-Rigid PVCu Panel
  - FRL Fibre Reinforced Laminated
  - FRP Fibreglass Reinforced Plastic
  - PVW Protective Vinyl Wallcovering
  - RHIS Rigid High Impact Sheet
  - WSSP Wetwall Solid Surface Panel
  - WVV Wetroom Vinyl Wallcovering
- FLOOR FINISHES LEGEND:**
- CFS Concrete Floor Sealer
  - EFC Epoxy Floor Coating
  - PFC Polyurethane Floor Coating
  - RAF Rubber Athletic Flooring
  - RSF Rubber Sheet Flooring
  - SCF Seamless Cushioned Flooring
  - SDRF Static-Dissipative Rubber Sheet Flooring
  - SDVF Static-Dissipative Vinyl Sheet Flooring
  - VSF Vinyl Sheet Flooring
  - WSVF Wetroom Safety Vinyl Sheet Flooring
- FLOOR BASE LEGEND:**
- FCB Flash Cove Base
  - RB Rubber Base
  - SCF Seamless Cushioned Flooring

**DOORS**

Types:

Type	Qty	Size (mm)	Material	Finish	Side Lt.	Blinds	Protect.	Privacy Film	Function	Card Reader	Mag Lock	Auto Opener	Hold Open	Hinges	Accessory 1	Accessory 2	Accessory 3	Closer
C2	1	1830 x 2135	Solid Core	FRL	<input type="checkbox"/>	<input type="checkbox"/>	2 High	<input checked="" type="checkbox"/>	Storeroom	<input checked="" type="checkbox"/>	<input type="checkbox"/>	<input type="checkbox"/>	<input type="checkbox"/>	Cont. Swing Clear	Astragal	Flush Bolt		Surface

**DOOR REMARKS:**

Security Grille  
 Anti-barricade strategy

**MILLWORK AND SPECIALTY CASEWORK**

Storage Requirements:

**UPPER UNITS:** U1 , U2 , U3 , U4 , U5 , U6 , U7 , U8

**LOWER UNITS:** L1 , L2 , L3 , L4 , L5 , L6 , L7 , L8 , L9 , L10 , L11 , L12

**RECEPTION/TRANSACTION COUNTER / CARE TEAM STATION DESK:** TC1 , TC2

**UTILITY SINK AND COUNTER UNIT:** UC1

**FINISHES**

Full-height Cabinet:	<input type="text" value="Plastic Laminate"/>
Upper Millwork:	<input type="text" value="Plastic Laminate"/>
Countertop:	<input type="text" value="Solid Surfacing"/>
Lower Millwork:	<input type="text" value="Plastic Laminate"/>
Shelf:	<input type="text"/>

**REMARKS:**

**MECHANICAL REQUIREMENTS**

<b>PLUMBING</b> (Quantity) Hand Hygiene Sink: <input type="text"/> Lavatory: <input type="text"/> Kitchen Sink: <input type="text"/> Seamless Kitchen Sink: <input type="text"/> Utility / Process Sink: <input type="text"/> Scrub Sink: <input type="text"/> Floor Sink: <input type="text"/>							Other Fixtures: <input type="checkbox"/> Shower <input type="checkbox"/> Tub <input type="checkbox"/> Ice Maker <input type="checkbox"/> Water Closet <input type="checkbox"/> Instantaneous Hot Water			<input type="checkbox"/> Eyewash Station <input type="checkbox"/> Eyewash/Shower Station <input type="checkbox"/> Emergency Shower <input type="checkbox"/> Flush Rim Sink <input type="checkbox"/> Floor Drain <input type="checkbox"/> Water Bottle Refill Station			<b>MED / NON-MED GASES</b> (Quantity) Oxygen: <input type="text"/> Medical Air: <input type="text"/> Medical Vacuum: <input type="text"/> Nitrous Oxide: <input type="text"/> CO2: <input type="text"/> AGSS: <input type="text"/> Nitrogen: <input type="text"/> Laboratory Air: <input type="text"/> Laboratory Vacuum: <input type="text"/> Utility Compressed Air: <input type="text"/>				
Plumbing Remarks: <input type="text"/>							Other: <input type="text"/>			Gas Remarks: <input type="text"/>							



**Appendix 1B Minimum Room Requirements**

Room Name:

Program Number(s):

1. K1.01	7.	13.	19.	25.	31.	37.	43.
2.	8.	14.	20.	26.	32.	38.	44.
3.	9.	15.	21.	27.	33.	39.	45.
4.	10.	16.	22.	28.	34.	40.	46.
5.	11.	17.	23.	29.	35.	41.	47.
6.	12.	18.	24.	30.	36.	42.	48.

**ARCHITECTURAL REQUIREMENTS**

<b>WALL AND CEILING</b> Wall Material: <input type="text" value="ARGB 1.2m AFF, GB above"/> Finish: <input type="text" value="HPC"/> Ceiling Material: <input type="text" value="ACT"/> Finish: <input type="text" value="PF"/>		<b>WALL PROTECTION</b> Type: <input type="text" value="FRP"/> <input checked="" type="checkbox"/> Corner Guards <input type="checkbox"/> Hand Rails <input type="checkbox"/> Bed Bumper / Locator Height: <input type="text" value="1600 mm"/> <input type="checkbox"/> Crash Rails <input checked="" type="checkbox"/> Chair Rail		<b>GLAZING</b> <input checked="" type="checkbox"/> Interior Glazing		<b>FLOORING TYPES</b> Material: <input type="text" value="VSF"/> Base: <input type="text" value="FCB"/>		<b>ROOM ACCESSORIES</b> <input checked="" type="checkbox"/> Coat Hooks <input type="checkbox"/> Ceiling Lift <input checked="" type="checkbox"/> Magnetic Whiteboard <input type="checkbox"/> Mirror <input type="checkbox"/> Infant Change Table <input type="checkbox"/> Privacy Curtain	
---	--	--	--	--	--	--	--	--	--

- LEGEND:**
- WALL AND CEILING LEGEND:**
- AC Architectural Ceiling
  - ACT Acoustic Ceiling Tile
  - ACT-C Cleanroom
  - ARGB Abuse-Resistant Gypsum Board
  - GB Gypsum Board
  - IRGB Impact-Resistant Gypsum Board
  - KLCT Kitchen Lay-in Ceiling Tile
  - MMRGB Moisture and Mould-Resistant Gypsum Board
  - SACT Security Acoustic Ceiling Tile
- WALL FINISHES LEGEND:**
- EWC Epoxy Wall Coating
  - HPC High Performance Coating
  - PT Paint
- CEILING FINISHES LEGEND:**
- ECC Epoxy Ceiling Coating
  - HPC High Performance Coating
  - PF Prefinished
  - PT Paint
- WALL PROTECTION LEGEND:**
- ESRP Extruded Semi-Rigid PVCu Panel
  - FRL Fibre Reinforced Laminate
  - FRP Fibreglass Reinforced Plastic
  - PVV Protective Vinyl Wallcovering
  - RHIS Rigid High Impact Sheet
  - WSSP Wetwall Solid Surface Panel
  - WVV Wetroom Vinyl Wallcovering
- FLOOR FINISHES LEGEND:**
- CFS Concrete Floor Sealer
  - EFC Epoxy Floor Coating
  - PFC Polyurethane Floor Coating
  - RAF Rubber Athletic Flooring
  - RSF Rubber Sheet Flooring
  - SCF Seamless Cushioned Flooring
  - SDRF Static-Dissipative Rubber Sheet Flooring
  - SDVF Static-Dissipative Vinyl Sheet Flooring
  - VSF Vinyl Sheet Flooring
  - WSVF Wetroom Safety Vinyl Sheet Flooring
- FLOOR BASE LEGEND:**
- FCB Flash Cove Base
  - RB Rubber Base
  - SCF Seamless Cushioned Flooring

**DOORS**

Types:

Type	Qty	Size (mm)	Material	Finish	Side Lt	Blinds	Protect	Privacy Film	Function	Card Reader	Mag Lock	Auto Opener	Hold Open	Hinges	Accessory 1	Accessory 2	Accessory 3	Closer
B	1	915 x 2135	Solid Core	FRL	<input type="checkbox"/>	<input type="checkbox"/>	2 High	<input checked="" type="checkbox"/>	Storeroom	<input checked="" type="checkbox"/>	<input type="checkbox"/>	<input type="checkbox"/>	<input type="checkbox"/>	Butt Hinge				Surface

Door Remarks:  Security Grille  Anti-barricade strategy

**MILLWORK AND SPECIALTY CASEWORK**

**UPPER UNITS** (U1-U8) **LOWER UNITS** (L1-L9)

**RECEPTION/TRANSACTION COUNTER / CARE TEAM STATION DESK** (TC1, TC2)

**UTILITY SINK AND COUNTER UNIT** (UC1)

**Storage Requirements:**  SHELF (S1)

**FINISHES**

- Full-height Cabinet:
- Upper Millwork:
- Countertop:
- Lower Millwork:
- Shelf:

Remarks:

**Legend:**

Category	Min. Length (mm)	Motorized Adjustable Height	Standing Height	Specialty Casework
3	12000	<input type="checkbox"/>	<input type="checkbox"/>	<input type="checkbox"/>

**MECHANICAL REQUIREMENTS**

<b>PLUMBING</b> (Quantity) Hand Hygiene Sink: <input type="text"/> Lavatory: <input type="text"/> Kitchen Sink: <input type="text"/> Seamless Kitchen Sink: <input type="text"/> Utility / Process Sink: <input type="text" value="1"/> Scrub Sink: <input type="text"/> Floor Sink: <input type="text"/>		Other Fixtures: <input type="checkbox"/> Shower <input type="checkbox"/> Tub <input type="checkbox"/> Ice Maker <input type="checkbox"/> Water Closet <input type="checkbox"/> Instantaneous Hot Water <input type="checkbox"/> Eyewash Station <input type="checkbox"/> Eyewash/Shower Station <input type="checkbox"/> Emergency Shower <input type="checkbox"/> Flush Rim Sink <input type="checkbox"/> Floor Drain <input type="checkbox"/> Water Bottle Refill Station Other: <input type="text"/>		<b>MED / NON-MED GASES</b> (Quantity) Oxygen: <input type="text"/> Medical Air: <input type="text"/> Medical Vacuum: <input type="text"/> Nitrous Oxide: <input type="text"/> CO2: <input type="text"/> AGSS: <input type="text"/> Nitrogen: <input type="text"/> Laboratory Air: <input type="text"/> Laboratory Vacuum: <input type="text"/> Utility Compressed Air: <input type="text"/>	
Plumbing Remarks: <input type="text"/>		Gas Remarks: <input type="text"/>			

**Appendix 1B Minimum Room Requirements**

Room Name:

Program Number(s):	1. K1.02	7.	13.	19.	25.	31.	37.	43.
	2.	8.	14.	20.	26.	32.	38.	44.
	3.	9.	15.	21.	27.	33.	39.	45.
	4.	10.	16.	22.	28.	34.	40.	46.
	5.	11.	17.	23.	29.	35.	41.	47.
	6.	12.	18.	24.	30.	36.	42.	48.

**ARCHITECTURAL REQUIREMENTS**

<b>WALL AND CEILING</b> Wall Material: <input type="text" value="ARGB 1.2m AFF, GB above"/> Finish: <input type="text" value="HPC"/> Ceiling Material: <input type="text" value="ACT"/> Finish: <input type="text" value="PF"/>	<b>WALL PROTECTION</b> Type: <input type="text" value="FRP"/> <input checked="" type="checkbox"/> Corner Guards <input type="checkbox"/> Hand Rails <input type="checkbox"/> Bed Bumper / Locator Height: <input type="text" value="1600 mm"/> <input type="checkbox"/> Crash Rails <input checked="" type="checkbox"/> Chair Rail	<b>GLAZING</b> <input checked="" type="checkbox"/> Interior Glazing	<b>FLOORING TYPES</b> Material: <input type="text" value="VSF"/> Base: <input type="text" value="RB"/>	<b>ROOM ACCESSORIES</b> <input checked="" type="checkbox"/> Coat Hooks <input type="checkbox"/> Ceiling Lift <input checked="" type="checkbox"/> Magnetic Whiteboard <input type="checkbox"/> Mirror <input type="checkbox"/> Infant Change Table <input type="checkbox"/> Privacy Curtain
---	--	--	---	--

- LEGEND:**
- WALL AND CEILING LEGEND:**
- AC Architectural Ceiling
  - ACT Acoustic Ceiling Tile
  - ACT-C Cleanroom
  - ARGB Abuse-Resistant Gypsum Board
  - GB Gypsum Board
  - IRGB Impact-Resistant Gypsum Board
  - KLCT Kitchen Lay-in Ceiling Tile
  - MMRGB Moisture and Mould-Resistant Gypsum Board
  - SACT Security Acoustic Ceiling Tile
- WALL FINISHES LEGEND:**
- EWC Epoxy Wall Coating
  - HPC High Performance Coating
  - PT Paint
- CEILING FINISHES LEGEND:**
- ECC Epoxy Ceiling Coating
  - HPC High Performance Coating
  - PF Prefinished
  - PT Paint
- WALL PROTECTION LEGEND:**
- ESRP Extruded Semi-Rigid PVCu Panel
  - FRL Fibre Reinforced Laminate
  - FRP Fibreglass Reinforced Plastic
  - PVV Protective Vinyl Wallcovering
  - RHIS Rigid High Impact Sheet
  - WSSP Wetwall Solid Surface Panel
  - WVV Wetroom Vinyl Wallcovering
- FLOOR FINISHES LEGEND:**
- CFS Concrete Floor Sealer
  - EFC Epoxy Floor Coating
  - PFC Polyurethane Floor Coating
  - RAF Rubber Athletic Flooring
  - RSF Rubber Sheet Flooring
  - SCF Seamless Cushioned Flooring
  - SDRF Static-Dissipative Rubber Sheet Flooring
  - SDVF Static-Dissipative Vinyl Sheet Flooring
  - VSF Vinyl Sheet Flooring
  - WSVF Wetroom Safety Vinyl Sheet Flooring
- FLOOR BASE LEGEND:**
- FCB Flash Cove Base
  - RB Rubber Base
  - SCF Seamless Cushioned Flooring

**DOORS**

Types:

Type	Qty	Size (mm)	Material	Finish	Side Lt.	Blinds	Protect.	Privacy Film	Function	Card Reader	Mag Lock	Auto Opener	Hold Open	Hinges	Accessory 1	Accessory 2	Accessory 3	Closer
B	1	915 x 2135	Solid Core	FRL	<input type="checkbox"/>	<input type="checkbox"/>	2 High	<input checked="" type="checkbox"/>	Storeroom	<input checked="" type="checkbox"/>	<input type="checkbox"/>	<input type="checkbox"/>	<input type="checkbox"/>	Butt Hinge				Surface

Door Remarks:  Security Grille  Anti-barricade strategy

**MILLWORK AND SPECIALTY CASEWORK**

**UPPER UNITS** (U1-U8) **LOWER UNITS** (L1-L12) **RECEPTION/TRANSACTION COUNTER / CARE TEAM STATION DESK** (TC1-TC2) **UTILITY SINK AND COUNTER UNIT** (UC1)

Storage Requirements:

**FINISHES**

Full-height Cabinet:   
 Upper Millwork:   
 Countertop:   
 Lower Millwork:   
 Shelf:

Remarks:

**Legend:**

Category	Min. Length (mm)	Motorized Adjustable Height	Standing Height	Specialty Casework
Category 0 - None		<input type="checkbox"/>	<input type="checkbox"/>	<input type="checkbox"/>
Category 1 - Low (1% - 4%)		<input type="checkbox"/>	<input type="checkbox"/>	<input type="checkbox"/>
Category 2 - Med (5% - 9%)		<input type="checkbox"/>	<input type="checkbox"/>	<input type="checkbox"/>
Category 3 - High (10% or Greater)		<input type="checkbox"/>	<input type="checkbox"/>	<input type="checkbox"/>

**MECHANICAL REQUIREMENTS**

<b>PLUMBING</b> (Quantity) Hand Hygiene Sink: <input type="text"/> Lavatory: <input type="text"/> Kitchen Sink: <input type="text"/> Seamless Kitchen Sink: <input type="text"/> Utility / Process Sink: <input type="text"/> Scrub Sink: <input type="text"/> Floor Sink: <input type="text"/> Plumbing Remarks: <input type="text"/>	Other Fixtures: <input type="checkbox"/> Shower <input type="checkbox"/> Eyewash Station <input type="checkbox"/> Tub <input type="checkbox"/> Eyewash/Shower Station <input type="checkbox"/> Ice Maker <input type="checkbox"/> Emergency Shower <input type="checkbox"/> Water Closet <input type="checkbox"/> Flush Rim Sink <input type="checkbox"/> Instantaneous Hot Water <input type="checkbox"/> Floor Drain <input type="checkbox"/> <input type="checkbox"/> Water Bottle Refill Station Other <input type="text"/>	<b>MED / NON-MED GASES</b> (Quantity) Oxygen: <input type="text"/> Medical Air: <input type="text"/> Medical Vacuum: <input type="text"/> Nitrous Oxide: <input type="text"/> CO2: <input type="text"/> AGSS: <input type="text"/> Nitrogen: <input type="text"/> Laboratory Air: <input type="text"/> Laboratory Vacuum: <input type="text"/> Utility Compressed Air: <input type="text"/> Gas Remarks: <input type="text"/>
---	--	---

**Appendix 1B Minimum Room Requirements**

Room Name:

Program Number(s):	1. K1.14	7.	13.	19.	25.	31.	37.	43.
	2.	8.	14.	20.	26.	32.	38.	44.
	3.	9.	15.	21.	27.	33.	39.	45.
	4.	10.	16.	22.	28.	34.	40.	46.
	5.	11.	17.	23.	29.	35.	41.	47.
	6.	12.	18.	24.	30.	36.	42.	48.

**ARCHITECTURAL REQUIREMENTS**

<b>WALL AND CEILING</b> Wall Material: <input type="text" value="ARGB"/> Finish: <input type="text" value="PT"/> Ceiling Material: <input type="text" value="ACT"/> Finish: <input type="text" value="PF"/>	<b>WALL PROTECTION</b> Type: <input type="text" value="RHIS"/> <input checked="" type="checkbox"/> Corner Guards <input type="checkbox"/> Hand Rails <input type="checkbox"/> Bed Bumper / Locator Height: <input type="text" value="2480 mm"/> <input type="checkbox"/> Crash Rails <input type="checkbox"/> Chair Rail	<b>GLAZING</b> <input type="checkbox"/> Interior Glazing	<b>FLOORING TYPES</b> Material: <input type="text" value="EFC"/> Base: <input type="text" value="FCB"/>	<b>ROOM ACCESSORIES</b> <input checked="" type="checkbox"/> Coat Hooks <input type="checkbox"/> Ceiling Lift <input checked="" type="checkbox"/> Magnetic Whiteboard <input type="checkbox"/> Mirror <input type="checkbox"/> Infant Change Table <input type="checkbox"/> Privacy Curtain
---	--	---	--	--

- LEGEND:**
- WALL AND CEILING LEGEND:**
- AC Architectural Ceiling
  - ACT Acoustic Ceiling Tile
  - ACT-C Cleanroom
  - ARGB Abuse-Resistant Gypsum Board
  - GB Gypsum Board
  - IRGB Impact-Resistant Gypsum Board
  - KLCT Kitchen Lay-in Ceiling Tile
  - MMRGB Moisture and Mould-Resistant Gypsum Board
  - SACT Security Acoustic Ceiling Tile
- WALL FINISHES LEGEND:**
- EWC Epoxy Wall Coating
  - HPC High Performance Coating
  - PT Paint
- CEILING FINISHES LEGEND:**
- ECC Epoxy Ceiling Coating
  - HPC High Performance Coating
  - PF Prefinished
  - PT Paint
- WALL PROTECTION LEGEND:**
- ESRP Extruded Semi-Rigid PVCu Panel
  - FRL Fibre Reinforced Laminate
  - FRP Fibreglass Reinforced Plastic
  - PVV Protective Vinyl Wallcovering
  - RHIS Rigid High Impact Sheet
  - WSSP Wetwall Solid Surface Panel
  - WVV Wetroom Vinyl Wallcovering
- FLOOR FINISHES LEGEND:**
- CFS Concrete Floor Sealer
  - EFC Epoxy Floor Coating
  - PFC Polyurethane Floor Coating
  - RAF Rubber Athletic Flooring
  - RSF Rubber Sheet Flooring
  - SCF Seamless Cushioned Flooring
  - SDRF Static-Dissipative Rubber Sheet Flooring
  - SDVF Static-Dissipative Vinyl Sheet Flooring
  - VSF Vinyl Sheet Flooring
  - WSVF Wetroom Safety Vinyl Sheet Flooring
- FLOOR BASE LEGEND:**
- FCB Flash Cove Base
  - RB Rubber Base
  - SCF Seamless Cushioned Flooring

**DOORS**

Types:

Type	Qty	Size (mm)	Material	Finish	Side Lt.	Blinds	Protect.	Privacy Film	Function	Card Reader	Mag Lock	Auto Opener	Hold Open	Hinges	Accessory 1	Accessory 2	Accessory 3	Closer
B2	1	1830 x 2440	Hollow Metal	Paint	<input type="checkbox"/>	<input type="checkbox"/>		<input checked="" type="checkbox"/>	Storeroom	<input checked="" type="checkbox"/>	<input type="checkbox"/>	<input type="checkbox"/>	<input type="checkbox"/>	Butt Hinge	Astragal	Flush Bolt		Surface

**DOOR REMARKS:**

Security Grille  
 Anti-barricade strategy

**MILLWORK AND SPECIALTY CASEWORK**

**UPPER UNITS:** U1, U2, U3, U4, U5, U6, U7, U8

**LOWER UNITS:** L1, L2, L3, L4, L5, L6, L7, L8, L9, L10, L11, L12

**RECEPTION/TRANSACTION COUNTER / CARE TEAM STATION DESK:** TC1, TC2

**UTILITY SINK AND COUNTER UNIT:** UC1

**SHELF:** S1

**Storage Requirements:**

Category	Min. Length (mm)	Motorized Adjustable Height	Standing Height	Specialty Casework
1	900	<input type="checkbox"/>	<input type="checkbox"/>	<input type="checkbox"/>

**FINISHES**

Full-height Cabinet:   
 Upper Millwork:   
 Countertop:   
 Lower Millwork:   
 Shelf:

**REMARKS:**

**MECHANICAL REQUIREMENTS**

<b>PLUMBING</b> (Quantity) Hygiene Sink: <input type="text" value="1"/> Lavatory: <input type="text"/> Kitchen Sink: <input type="text"/> Seamless Kitchen Sink: <input type="text"/> Utility / Process Sink: <input type="text" value="1"/> Scrub Sink: <input type="text"/> Floor Sink: <input type="text"/> Plumbing Remarks: <input type="text" value="Provide utility sink c/w plaster trap."/>	Other Fixtures: <input type="checkbox"/> Shower <input type="checkbox"/> Tub <input type="checkbox"/> Ice Maker <input type="checkbox"/> Water Closet <input type="checkbox"/> Instantaneous Hot Water <input checked="" type="checkbox"/> Ewewash Station <input type="checkbox"/> Eyewash/Shower Station <input type="checkbox"/> Emergency Shower <input type="checkbox"/> Flush Rim Sink <input checked="" type="checkbox"/> Floor Drain <input type="checkbox"/> Water Bottle Refill Station Other: <input type="text"/>	<b>MED / NON-MED GASES</b> (Quantity) Oxygen: <input type="text"/> Medical Air: <input type="text"/> Medical Vacuum: <input type="text"/> Nitrous Oxide: <input type="text"/> CO2: <input type="text"/> AGSS: <input type="text"/> Nitrogen: <input type="text"/> Laboratory Air: <input type="text"/> Laboratory Vacuum: <input type="text"/> Utility Compressed Air: <input type="text"/> Gas Remarks: <input type="text"/>
---	---	---



---

# New Surrey Hospital & BC Cancer Centre

MINIMUM ROOM REQUIREMENTS

## L. Radiation Therapy Delivery

---

**Appendix 1B Minimum Room Requirements**

Room Name:

Program Number(s):

1. L1.07	7.	13.	19.	25.	31.	37.	43.
2.	8.	14.	20.	26.	32.	38.	44.
3.	9.	15.	21.	27.	33.	39.	45.
4.	10.	16.	22.	28.	34.	40.	46.
5.	11.	17.	23.	29.	35.	41.	47.
6.	12.	18.	24.	30.	36.	42.	48.

**ARCHITECTURAL REQUIREMENTS**

<b>WALL AND CEILING</b> Wall Material: <input type="text" value="ARGB 1.2m AFF, GB above"/> Finish: <input type="text" value="PT"/> Ceiling Material: <input type="text" value="ACT"/> Finish: <input type="text" value="PF"/>	<b>WALL PROTECTION</b> Type: <input type="text" value="FRP"/> <input checked="" type="checkbox"/> Corner Guards <input type="checkbox"/> Hand Rails <input type="checkbox"/> Bed Bumper / Locator Height: <input type="text" value="1600 mm"/> <input type="checkbox"/> Crash Rails <input checked="" type="checkbox"/> Chair Rail	<b>GLAZING</b> <input type="checkbox"/> Interior Glazing	<b>FLOORING TYPES</b> Material: <input type="text" value="SDVF"/> Base: <input type="text" value="FCB"/>	<b>ROOM ACCESSORIES</b> <input checked="" type="checkbox"/> Coat Hooks <input type="checkbox"/> Ceiling Lift <input checked="" type="checkbox"/> Magnetic Whiteboard <input type="checkbox"/> Mirror <input type="checkbox"/> Infant Change Table <input type="checkbox"/> Privacy Curtain
--	--	---	---	--

- LEGEND:**
- WALL AND CEILING LEGEND:**
- AC Architectural Ceiling
  - ACT Acoustic Ceiling Tile
  - ACT-C Cleanroom
  - ARGB Abuse-Resistant Gypsum Board
  - GB Gypsum Board
  - IRGB Impact-Resistant Gypsum Board
  - KLCT Kitchen Lay-in Ceiling Tile
  - MMRGB Moisture and Mould-Resistant Gypsum Board
  - SACT Security Acoustic Ceiling Tile
- WALL FINISHES LEGEND:**
- EWC Epoxy Wall Coating
  - HPC High Performance Coating
  - PT Paint
- CEILING FINISHES LEGEND:**
- ECC Epoxy Ceiling Coating
  - HPC High Performance Coating
  - PF Prefinished
  - PT Paint
- WALL PROTECTION LEGEND:**
- ESRP Extruded Semi-Rigid PVCu Panel
  - FRL Fibre Reinforced Laminate
  - FRP Fibreglass Reinforced Plastic
  - PVV Protective Vinyl Wallcovering
  - RHIS Rigid High Impact Sheet
  - WSSP Wetwall Solid Surface Panel
  - WVV Wetroom Vinyl Wallcovering
- FLOOR FINISHES LEGEND:**
- CFS Concrete Floor Sealer
  - EFC Epoxy Floor Coating
  - PFC Polyurethane Floor Coating
  - RAF Rubber Athletic Flooring
  - RSF Rubber Sheet Flooring
  - SCF Seamless Cushioned Flooring
  - SDRF Static-Dissipative Rubber Sheet Flooring
  - SDVF Static-Dissipative Vinyl Sheet Flooring
  - VSF Vinyl Sheet Flooring
  - WSVF Wetroom Safety Vinyl Sheet Flooring
- FLOOR BASE LEGEND:**
- FCB Flash Cove Base
  - RB Rubber Base
  - SCF Seamless Cushioned Flooring

**DOORS**

Types:

Type	Qty	Size (mm)	Material	Finish	Side Lt.	Blinds	Protect.	Privacy Film	Function	Card Reader	Mag Lock	Auto Opener	Hold Open	Hinges	Accessory 1	Accessory 2	Accessory 3	Closer
A	1	1065 x 2135	Solid Core	FRL	<input type="checkbox"/>	<input type="checkbox"/>	1 Low	<input type="checkbox"/>	Storeroom	<input checked="" type="checkbox"/>	<input type="checkbox"/>	<input type="checkbox"/>	<input type="checkbox"/>	Butt Hinge				Surface

Door Remarks:  Security Grille  Anti-barricade strategy



**MECHANICAL REQUIREMENTS**

<b>PLUMBING</b> (Quantity) Hand Hygiene Sink: <input type="text"/> Lavatory: <input type="text"/> Kitchen Sink: <input type="text"/> Seamless Kitchen Sink: <input type="text"/> Utility / Process Sink: <input type="text"/> Scrub Sink: <input type="text"/> Floor Sink: <input type="text"/> Plumbing Remarks: <input type="text"/>	Other Fixtures: <input type="checkbox"/> Shower <input type="checkbox"/> Tub <input type="checkbox"/> Ice Maker <input type="checkbox"/> Water Closet <input type="checkbox"/> Instantaneous Hot Water <input type="checkbox"/> Eyewash Station <input type="checkbox"/> Eyewash/Shower Station <input type="checkbox"/> Emergency Shower <input type="checkbox"/> Flush Rim Sink <input type="checkbox"/> Floor Drain <input type="checkbox"/> Water Bottle Refill Station Other: <input type="text"/>	<b>MED / NON-MED GASES</b> (Quantity) Oxygen: <input type="text"/> Medical Air: <input type="text"/> Medical Vacuum: <input type="text"/> Nitrous Oxide: <input type="text"/> CO2: <input type="text"/> AGSS: <input type="text"/> Nitrogen: <input type="text"/> Laboratory Air: <input type="text"/> Laboratory Vacuum: <input type="text"/> Utility Compressed Air: <input type="text"/> Gas Remarks: <input type="text"/>
---	--	---

**Appendix 1B Minimum Room Requirements**

Room Name:

Program Number(s):

1. L1.05	7.	13.	19.	25.	31.	37.	43.
2.	8.	14.	20.	26.	32.	38.	44.
3.	9.	15.	21.	27.	33.	39.	45.
4.	10.	16.	22.	28.	34.	40.	46.
5.	11.	17.	23.	29.	35.	41.	47.
6.	12.	18.	24.	30.	36.	42.	48.

**ARCHITECTURAL REQUIREMENTS**

<b>WALL AND CEILING</b> Wall Material: <input type="text" value="ARGB 1.2m AFF, GB above"/> Finish: <input type="text" value="PT"/> Ceiling Material: <input type="text" value="ACT"/> Finish: <input type="text" value="PF"/>		<b>WALL PROTECTION</b> Type: <input type="text" value="FRP"/> <input checked="" type="checkbox"/> Corner Guards <input type="checkbox"/> Hand Rails <input type="checkbox"/> Bed Bumper / Locator Height: <input type="text" value="1600 mm"/> <input type="checkbox"/> Crash Rails <input checked="" type="checkbox"/> Chair Rail		<b>GLAZING</b> <input type="checkbox"/> Interior Glazing		<b>FLOORING TYPES</b> Material: <input type="text" value="SDVF"/> Base: <input type="text" value="FCB"/>		<b>ROOM ACCESSORIES</b> <input checked="" type="checkbox"/> Coat Hooks <input type="checkbox"/> Ceiling Lift <input checked="" type="checkbox"/> Magnetic Whiteboard <input type="checkbox"/> Mirror <input type="checkbox"/> Infant Change Table <input type="checkbox"/> Privacy Curtain	
--	--	--	--	---	--	---	--	--	--

- LEGEND:**
- WALL AND CEILING LEGEND:**
- AC Architectural Ceiling
  - ACT Acoustic Ceiling Tile
  - ACT-C Cleanroom
  - ARGB Abuse-Resistant Gypsum Board
  - GB Gypsum Board
  - IRGB Impact-Resistant Gypsum Board
  - KLCT Kitchen Lay-in Ceiling Tile
  - MMRGB Moisture and Mould-Resistant Gypsum Board
  - SACT Security Acoustic Ceiling Tile
- WALL FINISHES LEGEND:**
- EWC Epoxy Wall Coating
  - HPC High Performance Coating
  - PT Paint
- CEILING FINISHES LEGEND:**
- ECC Epoxy Ceiling Coating
  - HPC High Performance Coating
  - PF Prefinished
  - PT Paint
- WALL PROTECTION LEGEND:**
- ESRP Extruded Semi-Rigid PVCu Panel
  - FRL Fibre Reinforced Laminate
  - FRP Fibreglass Reinforced Plastic
  - PVV Protective Vinyl Wallcovering
  - RHIS Rigid High Impact Sheet
  - WSSP Wetwall Solid Surface Panel
  - WVV Wetroom Vinyl Wallcovering
- FLOOR FINISHES LEGEND:**
- CFS Concrete Floor Sealer
  - EFC Epoxy Floor Coating
  - PFC Polyurethane Floor Coating
  - RAF Rubber Athletic Flooring
  - RSF Rubber Sheet Flooring
  - SCF Seamless Cushioned Flooring
  - SDRF Static-Dissipative Rubber Sheet Flooring
  - SDVF Static-Dissipative Vinyl Sheet Flooring
  - VSF Vinyl Sheet Flooring
  - WSVF Wetroom Safety Vinyl Sheet Flooring
- FLOOR BASE LEGEND:**
- FCB Flash Cove Base
  - RB Rubber Base
  - SCF Seamless Cushioned Flooring

**DOORS**

Types:

Type	Qty	Size (mm)	Material	Finish	Side Lt.	Blinds	Protect.	Privacy Film	Function	Card Reader	Mag Lock	Auto Opener	Hold Open	Hinges	Accessory 1	Accessory 2	Accessory 3	Closer
A	1	1065 x 2135	Solid Core	FRL	<input type="checkbox"/>	<input type="checkbox"/>	1 Low	<input type="checkbox"/>	Storeroom	<input checked="" type="checkbox"/>	<input type="checkbox"/>	<input type="checkbox"/>	<input type="checkbox"/>	Butt Hinge				Surface

Door Remarks: Refer to Appendix 1A [Clinical Specifications and Functional Space Requirements], section 2.12 for door requirements.

Security Grille  
 Anti-barricade strategy

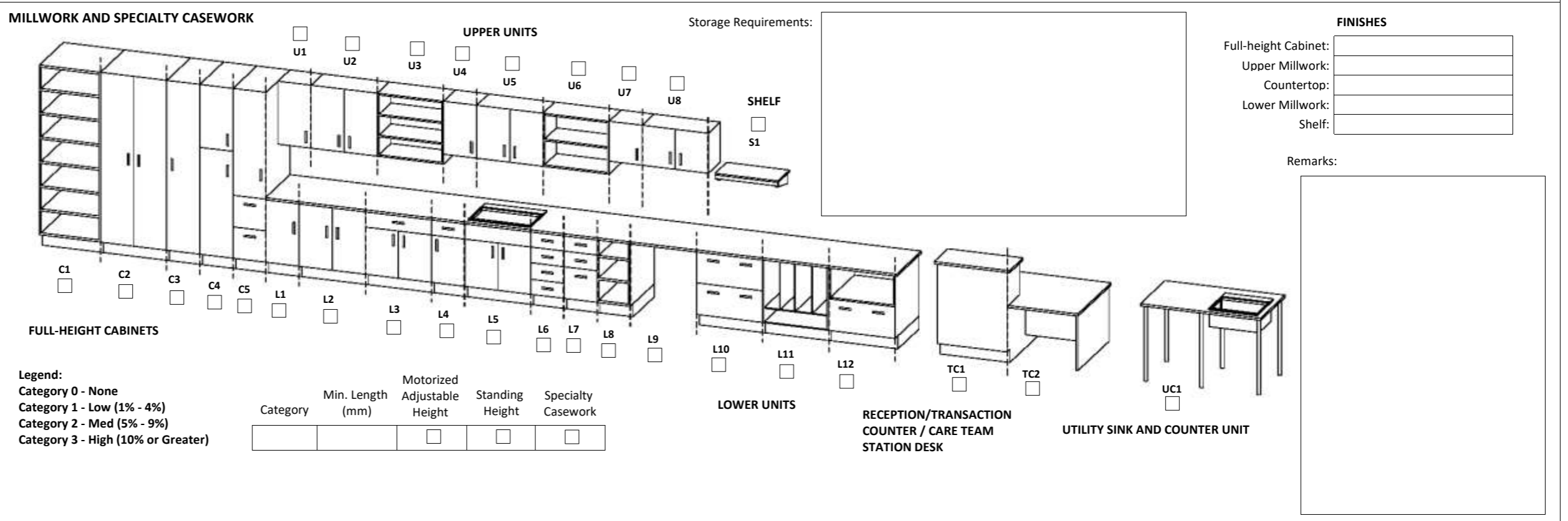

**MECHANICAL REQUIREMENTS**

<b>PLUMBING</b> (Quantity) Hand Hygiene Sink: <input type="text" value="1"/> Lavatory: <input type="text"/> Kitchen Sink: <input type="text"/> Seamless Kitchen Sink: <input type="text"/> Utility / Process Sink: <input type="text"/> Scrub Sink: <input type="text"/> Floor Sink: <input type="text"/> Plumbing Remarks: <input type="text" value="Provide (1) HHS per 2 rooms, to be located centrally outside Control Room"/>		Other Fixtures: <input type="checkbox"/> Shower <input type="checkbox"/> Eyewash Station <input type="checkbox"/> Tub <input type="checkbox"/> Eyewash/Shower Station <input type="checkbox"/> Ice Maker <input type="checkbox"/> Emergency Shower <input type="checkbox"/> Water Closet <input type="checkbox"/> Flush Rim Sink <input type="checkbox"/> Instantaneous Hot Water <input type="checkbox"/> Floor Drain <input type="checkbox"/> <input type="checkbox"/> Water Bottle Refill Station Other: <input type="text"/>		<b>MED / NON-MED GASES</b> (Quantity) Oxygen: <input type="text"/> Medical Air: <input type="text"/> Medical Vacuum: <input type="text"/> Nitrous Oxide: <input type="text"/> CO2: <input type="text"/> AGSS: <input type="text"/> Nitrogen: <input type="text"/> Laboratory Air: <input type="text"/> Laboratory Vacuum: <input type="text"/> Utility Compressed Air: <input type="text"/> Gas Remarks: <input type="text"/>	
--	--	---	--	---	--



**Appendix 1B Minimum Room Requirements**

Room Name:

Program Number(s):

1. L1.06	7.	13.	19.	25.	31.	37.	43.
2.	8.	14.	20.	26.	32.	38.	44.
3.	9.	15.	21.	27.	33.	39.	45.
4.	10.	16.	22.	28.	34.	40.	46.
5.	11.	17.	23.	29.	35.	41.	47.
6.	12.	18.	24.	30.	36.	42.	48.

**ARCHITECTURAL REQUIREMENTS**

<b>WALL AND CEILING</b> Wall Material: <input type="text" value="ARGB 1.2m AFF, GB above"/> Finish: <input type="text" value="PT"/> Ceiling Material: <input type="text" value="ACT"/> Finish: <input type="text" value="PF"/>	<b>WALL PROTECTION</b> Type: <input type="text" value="ESRP"/> <input checked="" type="checkbox"/> Corner Guards <input type="checkbox"/> Hand Rails <input type="checkbox"/> Bed Bumper / Locator Height: <input type="text" value="2185 mm"/> <input type="checkbox"/> Crash Rails <input checked="" type="checkbox"/> Chair Rail	<b>GLAZING</b> <input type="checkbox"/> Interior Glazing	<b>FLOORING TYPES</b> Material: <input type="text" value="SDVF"/> Base: <input type="text" value="FCB"/>	<b>ROOM ACCESSORIES</b> <input checked="" type="checkbox"/> Coat Hooks <input checked="" type="checkbox"/> Ceiling Lift <input checked="" type="checkbox"/> Magnetic Whiteboard <input type="checkbox"/> Mirror <input type="checkbox"/> Infant Change Table <input checked="" type="checkbox"/> Privacy Curtain
--	---	---	---	--

- LEGEND:**
- WALL AND CEILING LEGEND:**
- AC Architectural Ceiling
  - ACT Acoustic Ceiling Tile
  - ACT-C Cleanroom
  - ARGB Abuse-Resistant Gypsum Board
  - GB Gypsum Board
  - IRGB Impact-Resistant Gypsum Board
  - KLCT Kitchen Lay-in Ceiling Tile
  - MMRGB Moisture and Mould-Resistant Gypsum Board
  - SACT Security Acoustic Ceiling Tile
- WALL FINISHES LEGEND:**
- EWC Epoxy Wall Coating
  - HPC High Performance Coating
  - PT Paint
- CEILING FINISHES LEGEND:**
- ECC Epoxy Ceiling Coating
  - HPC High Performance Coating
  - PF Prefinished
  - PT Paint
- WALL PROTECTION LEGEND:**
- ESRP Extruded Semi-Rigid PVCu Panel
  - FRL Fibre Reinforced Laminate
  - FRP Fibreglass Reinforced Plastic
  - PVV Protective Vinyl Wallcovering
  - RHIS Rigid High Impact Sheet
  - WSSP Wetwall Solid Surface Panel
  - WVV Wetroom Vinyl Wallcovering
- FLOOR FINISHES LEGEND:**
- CFS Concrete Floor Sealer
  - EFC Epoxy Floor Coating
  - PFC Polyurethane Floor Coating
  - RAF Rubber Athletic Flooring
  - RSF Rubber Sheet Flooring
  - SCF Seamless Cushioned Flooring
  - SDRF Static-Dissipative Rubber Sheet Flooring
  - SDVF Static-Dissipative Vinyl Sheet Flooring
  - VSF Vinyl Sheet Flooring
  - WSVF Wetroom Safety Vinyl Sheet Flooring
- FLOOR BASE LEGEND:**
- FCB Flash Cove Base
  - RB Rubber Base
  - SCF Seamless Cushioned Flooring

**DOORS**

Types:

Type	Qty	Size (mm)	Material	Finish	Side Lt.	Blinds	Protect.	Privacy Film	Function	Card Reader	Mag Lock	Auto Opener	Hold Open	Hinges	Accessory 1	Accessory 2	Accessory 3	Closer
A	1	1220 x 2135	Shielded	Prefinished	<input type="checkbox"/>	<input checked="" type="checkbox"/>	2 High	<input type="checkbox"/>	Classroom	<input type="checkbox"/>	<input checked="" type="checkbox"/>	<input checked="" type="checkbox"/>	<input type="checkbox"/>	Butt Hinge	Elec. Strike			Concealed

Door Remarks:  Security Grille  Anti-barricade strategy

**MILLWORK AND SPECIALTY CASEWORK**

**UPPER UNITS** (U1-U8) **LOWER UNITS** (L1-L9)

**RECEPTION/TRANSACTION COUNTER / CARE TEAM STATION DESK** (TC1, TC2)

**UTILITY SINK AND COUNTER UNIT** (UC1)

**Storage Requirements:**  SHELF (S1)

**FINISHES**

- Full-height Cabinet:
- Upper Millwork:
- Countertop:
- Lower Millwork:
- Shelf:

Remarks:

**MECHANICAL REQUIREMENTS**

<b>PLUMBING</b> (Quantity) Hand Hygiene Sink: <input type="text" value="1"/> Lavatory: <input type="text"/> Kitchen Sink: <input type="text"/> Utility / Process Sink: <input type="text" value="1"/> Scrub Sink: <input type="text"/> Floor Sink: <input type="text"/> Plumbing Remarks: <input type="text" value="Utility sink to have hose bib connection Manual tap for filling water tank (QA purposes)"/>	Other Fixtures: <input type="checkbox"/> Shower <input type="checkbox"/> Eyewash Station <input type="checkbox"/> Tub <input type="checkbox"/> Eyewash/Shower Station <input type="checkbox"/> Ice Maker <input type="checkbox"/> Emergency Shower <input type="checkbox"/> Water Closet <input type="checkbox"/> Flush Rim Sink <input type="checkbox"/> Instantaneous Hot Water <input type="checkbox"/> Floor Drain <input type="checkbox"/> <input type="checkbox"/> Water Bottle Refill Station Other: <input type="text"/>	<b>MED / NON-MED GASES</b> (Quantity) Oxygen: <input type="text" value="2"/> Medical Air: <input type="text" value="1"/> Medical Vacuum: <input type="text"/> Nitrous Oxide: <input type="text"/> CO2: <input type="text"/> AGSS: <input type="text"/> Nitrogen: <input type="text"/> Laboratory Air: <input type="text"/> Laboratory Vacuum: <input type="text"/> Utility Compressed Air: <input type="text"/> Gas Remarks: <input type="text"/>
---	---	---

# Appendix 1B Minimum Room Requirements

Room Name:

Program Number(s):

1. L1.04	7.	13.	19.	25.	31.	37.	43.
2.	8.	14.	20.	26.	32.	38.	44.
3.	9.	15.	21.	27.	33.	39.	45.
4.	10.	16.	22.	28.	34.	40.	46.
5.	11.	17.	23.	29.	35.	41.	47.
6.	12.	18.	24.	30.	36.	42.	48.

## ARCHITECTURAL REQUIREMENTS

<b>WALL AND CEILING</b> Wall Material: <input type="text" value="ARGB 1.2m AFF, GB above"/> Finish: <input type="text" value="PT"/> Ceiling Material: <input type="text" value="ACT"/> Finish: <input type="text" value="PF"/>	<b>WALL PROTECTION</b> Type: <input type="text" value="FRP"/> <input checked="" type="checkbox"/> Corner Guards <input checked="" type="checkbox"/> Hand Rails <input type="checkbox"/> Bed Bumper / Locator Height: <input type="text" value="2185 mm"/> <input type="checkbox"/> Crash Rails <input checked="" type="checkbox"/> Chair Rail	<b>GLAZING</b> <input type="checkbox"/> Interior Glazing	<b>FLOORING TYPES</b> Material: <input type="text" value="VSF"/> Base: <input type="text" value="FCB"/>	<b>ROOM ACCESSORIES</b> <input checked="" type="checkbox"/> Coat Hooks <input checked="" type="checkbox"/> Ceiling Lift <input checked="" type="checkbox"/> Magnetic Whiteboard <input checked="" type="checkbox"/> Mirror <input type="checkbox"/> Infant Change Table <input checked="" type="checkbox"/> Privacy Curtain
--	---	---	--	---

- LEGEND:**
- WALL AND CEILING LEGEND:**
- AC Architectural Ceiling
  - ACT Acoustic Ceiling Tile
  - ACT-C Cleanroom
  - ARGB Abuse-Resistant Gypsum Board
  - GB Gypsum Board
  - IRGB Impact-Resistant Gypsum Board
  - KLCT Kitchen Lay-in Ceiling Tile
  - MMRGB Moisture and Mould-Resistant Gypsum Board
  - SACT Security Acoustic Ceiling Tile
- WALL FINISHES LEGEND:**
- EWC Epoxy Wall Coating
  - HPC High Performance Coating
  - PT Paint
- CEILING FINISHES LEGEND:**
- ECC Epoxy Ceiling Coating
  - HPC High Performance Coating
  - PF Prefinished
  - PT Paint
- WALL PROTECTION LEGEND:**
- ESRP Extruded Semi-Rigid PVCu Panel
  - FRL Fibre Reinforced Laminate
  - FRP Fibreglass Reinforced Plastic
  - PVV Protective Vinyl Wallcovering
  - RHIS Rigid High Impact Sheet
  - WSSP Wetwall Solid Surface Panel
  - WWW Wetroom Vinyl Wallcovering
- FLOOR FINISHES LEGEND:**
- CFS Concrete Floor Sealer
  - EFC Epoxy Floor Coating
  - PFC Polyurethane Floor Coating
  - RAF Rubber Athletic Flooring
  - RSF Rubber Sheet Flooring
  - SCF Seamless Cushioned Flooring
  - SDRF Static-Dissipative Rubber Sheet Flooring
  - SDVF Static-Dissipative Vinyl Sheet Flooring
  - VSF Vinyl Sheet Flooring
  - WSVF Wetroom Safety Vinyl Sheet Flooring
- FLOOR BASE LEGEND:**
- FCB Flash Cove Base
  - RB Rubber Base
  - SCF Seamless Cushioned Flooring

**DOORS**

Types:

Type	Qty	Size (mm)	Material	Finish	Side Lt.	Blinds	Protect.	Privacy Film	Function	Card Reader	Mag Lock	Auto Opener	Hold Open	Hinges	Accessory 1	Accessory 2	Accessory 3	Closer
A	1	1220 x 2135	Neutron	Prefinished	<input type="checkbox"/>	<input type="checkbox"/>		<input type="checkbox"/>		<input type="checkbox"/>	<input type="checkbox"/>	<input type="checkbox"/>	<input type="checkbox"/>					
A	1	1220 x 2135	Solid Core	Prefinished	<input type="checkbox"/>	<input type="checkbox"/>		<input type="checkbox"/>	Passage	<input type="checkbox"/>	<input type="checkbox"/>	<input type="checkbox"/>	<input checked="" type="checkbox"/>	Butt Hinge				Concealed

**Door Remarks:**  
 Refer to Schedule 1, section 6.8.10. for Neutron door requirements.  
 Refer to Appendix 1A [Clinical Specifications and Functional Space Requirements], section 2.12 for door requirements.  
 Neutron door will be sized to provide a 1220 mm clear opening width

Security Grille  
 Anti-barricade strategy

**MILLWORK AND SPECIALTY CASEWORK**

Storage Requirements:

**UPPER UNITS** (U1-U8)

**LOWER UNITS** (L1-L12)

**RECEPTION/TRANSACTION COUNTER / CARE TEAM STATION DESK** (TC1, TC2)

**UTILITY SINK AND COUNTER UNIT** (UC1)

**SHELF** (S1)

**FULL-HEIGHT CABINETS** (C1-C5)

**Legend:**  
 Category 0 - None  
 Category 1 - Low (1% - 4%)  
 Category 2 - Med (5% - 9%)  
 Category 3 - High (10% or Greater)

Category	Min. Length (mm)	Motorized Adjustable Height	Standing Height	Specialty Casework
1	2700	<input type="checkbox"/>	<input type="checkbox"/>	<input type="checkbox"/>

**FINISHES**

Full-height Cabinet:	Plastic Laminate
Upper Millwork:	Plastic Laminate
Countertop:	Solid Surfacing
Lower Millwork:	Plastic Laminate
Shelf:	

**Remarks:**  
 Refer to Schedule 1: Trapeze and Hoist Bar for ceiling equipment requirements  
 To provide hand rails on one side to the Maze.  
 Provide (1) set of concave mirrors for safety and (1) set of wall mounted mirror for patient use

## MECHANICAL REQUIREMENTS

**PLUMBING**

Hand Hygiene Sink: <input type="text" value="1"/>	Lavatory: <input type="text"/>	Kitchen Sink: <input type="text"/>	Seamless Kitchen Sink: <input type="text"/>	Utility / Process Sink: <input type="text" value="1"/>	Scrub Sink: <input type="text"/>	Floor Sink: <input type="text"/>
---	--------------------------------	------------------------------------	---	--	----------------------------------	----------------------------------

Plumbing Remarks:

**Other Fixtures:**

- Shower
- Tub
- Ice Maker
- Water Closet
- Instantaneous Hot Water
- Eyewash Station
- Eyewash/Shower Station
- Emergency Shower
- Flush Rim Sink
- Floor Drain
- Water Bottle Refill Station

**MED / NON-MED GASES**

Oxygen: <input type="text" value="2"/>	Medical Air: <input type="text" value="1"/>	Medical Vacuum: <input type="text"/>	Nitrous Oxide: <input type="text"/>	CO2: <input type="text"/>	AGSS: <input type="text"/>	Nitrogen: <input type="text"/>	Laboratory Air: <input type="text"/>	Laboratory Vacuum: <input type="text"/>	Utility Compressed Air: <input type="text" value="1"/>
--	---	--------------------------------------	-------------------------------------	---------------------------	----------------------------	--------------------------------	--------------------------------------	---	--

Gas Remarks:

**Appendix 1B Minimum Room Requirements**

Room Name:

Program Number(s):

1. L2.19	7.	13.	19.	25.	31.	37.	43.
2.	8.	14.	20.	26.	32.	38.	44.
3.	9.	15.	21.	27.	33.	39.	45.
4.	10.	16.	22.	28.	34.	40.	46.
5.	11.	17.	23.	29.	35.	41.	47.
6.	12.	18.	24.	30.	36.	42.	48.

**ARCHITECTURAL REQUIREMENTS**

<b>WALL AND CEILING</b> Wall Material: <input type="text" value="ARGB 1.2m AFF, GB above"/> Finish: <input type="text" value="PT"/> Ceiling Material: <input type="text" value="GB"/> Finish: <input type="text" value="ECC"/>		<b>WALL PROTECTION</b> Type: <input type="text" value="ESRP"/> <input checked="" type="checkbox"/> Corner Guards <input type="checkbox"/> Hand Rails <input type="checkbox"/> Bed Bumper / Locator Height: <input type="text" value="2185 mm"/> <input type="checkbox"/> Crash Rails <input type="checkbox"/> Chair Rail		<b>GLAZING</b> <input type="checkbox"/> Interior Glazing		<b>FLOORING TYPES</b> Material: <input type="text" value="SDRF"/> Base: <input type="text" value="FCB"/>		<b>ROOM ACCESSORIES</b> <input checked="" type="checkbox"/> Coat Hooks <input type="checkbox"/> Ceiling Lift <input type="checkbox"/> Magnetic Whiteboard <input type="checkbox"/> Mirror <input type="checkbox"/> Infant Change Table <input checked="" type="checkbox"/> Privacy Curtain	
--	--	--	--	---	--	---	--	--	--

- LEGEND:**
- WALL AND CEILING LEGEND:**
- AC Architectural Ceiling
  - ACT Acoustic Ceiling Tile
  - ACT-C Cleanroom
  - ARGB Abuse-Resistant Gypsum Board
  - GB Gypsum Board
  - IRGB Impact-Resistant Gypsum Board
  - KLCT Kitchen Lay-in Ceiling Tile
  - MMRGB Moisture and Mould-Resistant Gypsum Board
  - SACT Security Acoustic Ceiling Tile
- WALL FINISHES LEGEND:**
- EWC Epoxy Wall Coating
  - HPC High Performance Coating
  - PT Paint
- CEILING FINISHES LEGEND:**
- ECC Epoxy Ceiling Coating
  - HPC High Performance Coating
  - PF Prefinished
  - PT Paint
- WALL PROTECTION LEGEND:**
- ESRP Extruded Semi-Rigid PVCu Panel
  - FRL Fibre Reinforced Laminate
  - FRP Fibreglass Reinforced Plastic
  - PVV Protective Vinyl Wallcovering
  - RHIS Rigid High Impact Sheet
  - WSSP Wetwall Solid Surface Panel
  - WVV Wetroom Vinyl Wallcovering
- FLOOR FINISHES LEGEND:**
- CFS Concrete Floor Sealer
  - EFC Epoxy Floor Coating
  - PFC Polyurethane Floor Coating
  - RAF Rubber Athletic Flooring
  - RSF Rubber Sheet Flooring
  - SCF Seamless Cushioned Flooring
  - SDRF Static-Dissipative Rubber Sheet Flooring
  - SDVF Static-Dissipative Vinyl Sheet Flooring
  - VSF Vinyl Sheet Flooring
  - WSVF Wetroom Safety Vinyl Sheet Flooring
- FLOOR BASE LEGEND:**
- FCB Flash Cove Base
  - RB Rubber Base
  - SCF Seamless Cushioned Flooring

**DOORS**

Types:

Note: for Type F doors, the door panels will be approximately 465/1065 unless otherwise required by the Authority

Type	Qty	Size (mm)	Material	Finish	Side Lt.	Blinds	Protect.	Privacy Film	Function	Card Reader	Mag Lock	Auto Opener	Hold Open	Hinges	Accessory 1	Accessory 2	Accessory 3	Closer
F	1	1530 x 2135	Solid Core	FRL	<input type="checkbox"/>	<input type="checkbox"/>	2 High	<input type="checkbox"/>	Storeroom	<input checked="" type="checkbox"/>	<input type="checkbox"/>	<input type="checkbox"/>	<input type="checkbox"/>	Butt Hinge	Astragal	Flush Bolt		Concealed

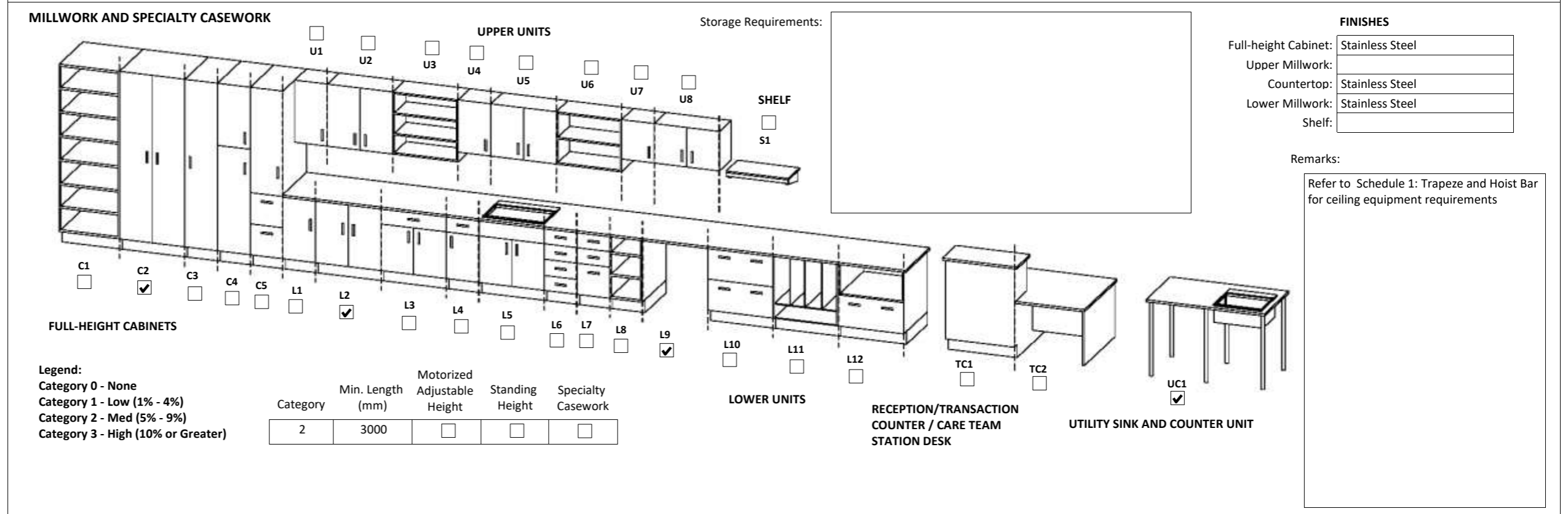

**MECHANICAL REQUIREMENTS**

<b>PLUMBING</b> (Quantity)		Hand Hygiene Sink: <input type="text" value="1"/> Lavatory: <input type="text"/> Kitchen Sink: <input type="text"/>		Seamless Kitchen Sink: <input type="text"/> Utility / Process Sink: <input type="text" value="1"/> Scrub Sink: <input type="text"/> Floor Sink: <input type="text"/>		Other Fixtures:		<b>MED / NON-MED GASES</b> (Quantity)	
Plumbing Remarks: <input type="text"/>		<input type="checkbox"/> Shower <input type="checkbox"/> Tub <input type="checkbox"/> Ice Maker <input type="checkbox"/> Water Closet <input type="checkbox"/> Instantaneous Hot Water		<input type="checkbox"/> Eyewash Station <input type="checkbox"/> Eyewash/Shower Station <input type="checkbox"/> Emergency Shower <input type="checkbox"/> Flush Rim Sink <input type="checkbox"/> Floor Drain <input type="checkbox"/> Water Bottle Refill Station		Oxygen: <input type="text" value="1"/> Medical Air: <input type="text" value="1"/> Medical Vacuum: <input type="text" value="1"/> Nitrous Oxide: <input type="text"/> CO2: <input type="text"/> AGSS: <input type="text"/> Nitrogen: <input type="text"/> Laboratory Air: <input type="text"/> Laboratory Vacuum: <input type="text"/> Utility Compressed Air: <input type="text"/>		Gas Remarks: <input type="text"/>	



**Appendix 1B Minimum Room Requirements**

Room Name:

Program Number(s):	1. L3.08	7.	13.	19.	25.	31.	37.	43.
	2.	8.	14.	20.	26.	32.	38.	44.
	3.	9.	15.	21.	27.	33.	39.	45.
	4.	10.	16.	22.	28.	34.	40.	46.
	5.	11.	17.	23.	29.	35.	41.	47.
	6.	12.	18.	24.	30.	36.	42.	48.

**ARCHITECTURAL REQUIREMENTS**

<b>WALL AND CEILING</b> Wall Material: <input type="text" value="ARGB 1.2m AFF, GB above"/> Finish: <input type="text" value="PT"/> Ceiling Material: <input type="text" value="ACT"/> Finish: <input type="text" value="PF"/>	<b>WALL PROTECTION</b> Type: <input type="text" value="PVW"/> <input checked="" type="checkbox"/> Corner Guards <input type="checkbox"/> Hand Rails <input type="checkbox"/> Bed Bumper / Locator Height: <input type="text" value="1350 mm"/> <input type="checkbox"/> Crash Rails <input checked="" type="checkbox"/> Chair Rail	<b>GLAZING</b> <input type="checkbox"/> Interior Glazing	<b>FLOORING TYPES</b> Material: <input type="text" value="VSF"/> Base: <input type="text" value="RB"/>	<b>ROOM ACCESSORIES</b> <input checked="" type="checkbox"/> Coat Hooks <input type="checkbox"/> Ceiling Lift <input checked="" type="checkbox"/> Magnetic Whiteboard <input type="checkbox"/> Mirror <input type="checkbox"/> Infant Change Table <input type="checkbox"/> Privacy Curtain
--	--	---	---	--

- LEGEND:**
- WALL AND CEILING LEGEND:**
- AC Architectural Ceiling
  - ACT Acoustic Ceiling Tile
  - ACT-C Cleanroom
  - ARGB Abuse-Resistant Gypsum Board
  - GB Gypsum Board
  - IRGB Impact-Resistant Gypsum Board
  - KLCT Kitchen Lay-in Ceiling Tile
  - MMRGB Moisture and Mould-Resistant Gypsum Board
  - SACT Security Acoustic Ceiling Tile
- WALL FINISHES LEGEND:**
- EWC Epoxy Wall Coating
  - HPC High Performance Coating
  - PT Paint
- CEILING FINISHES LEGEND:**
- ECC Epoxy Ceiling Coating
  - HPC High Performance Coating
  - PF Prefinished
  - PT Paint
- WALL PROTECTION LEGEND:**
- ESRP Extruded Semi-Rigid PVCu Panel
  - FRL Fibre Reinforced Laminata
  - FRP Fibreglass Reinforced Plastic
  - PVW Protective Vinyl Wallcovering
  - RHIS Rigid High Impact Sheet
  - WSSP Wetwall Solid Surface Panel
  - WVV Wetroom Vinyl Wallcovering
- FLOOR FINISHES LEGEND:**
- CFS Concrete Floor Sealer
  - EFC Epoxy Floor Coating
  - PFC Polyurethane Floor Coating
  - RAF Rubber Athletic Flooring
  - RSF Rubber Sheet Flooring
  - SCF Seamless Cushioned Flooring
  - SDRF Static-Dissipative Rubber Sheet Flooring
  - SDVF Static-Dissipative Vinyl Sheet Flooring
  - VSF Vinyl Sheet Flooring
  - WSVF Wetroom Safety Vinyl Sheet Flooring
- FLOOR BASE LEGEND:**
- FCB Flash Cove Base
  - RB Rubber Base
  - SCF Seamless Cushioned Flooring

**DOORS**

Types:

Type	Qty	Size (mm)	Material	Finish	Side Lt	Blinds	Protect	Privacy Film	Function	Card Reader	Mag Lock	Auto Opener	Hold Open	Hinges	Accessory 1	Accessory 2	Accessory 3	Closer
C	1	915 x 2135	Solid Core	FRL	<input type="checkbox"/>	<input type="checkbox"/>	1 Low	<input type="checkbox"/>	Storeroom	<input checked="" type="checkbox"/>	<input type="checkbox"/>	<input type="checkbox"/>	<input type="checkbox"/>	Butt Hinge				Surface

Door Remarks:  Security Grille  Anti-barricade strategy

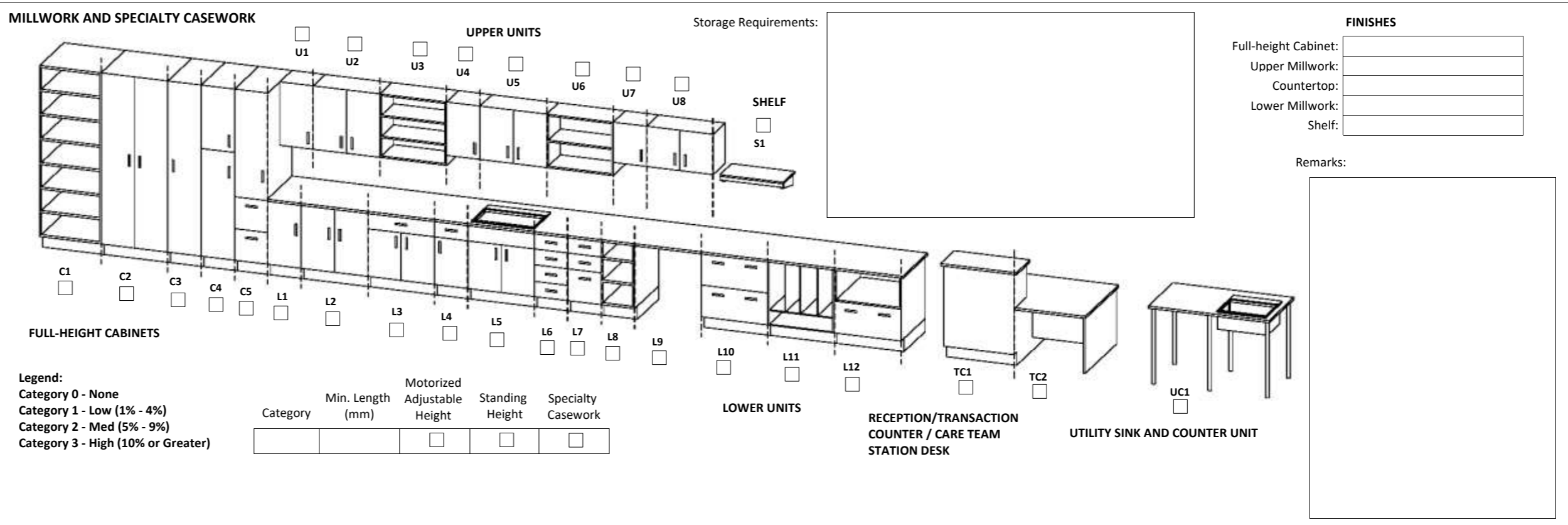

**MECHANICAL REQUIREMENTS**

<b>PLUMBING</b> (Quantity) Hand Hygiene Sink: <input type="text"/> Lavatory: <input type="text"/> Kitchen Sink: <input type="text"/> Seamless Kitchen Sink: <input type="text"/> Utility / Process Sink: <input type="text"/> Scrub Sink: <input type="text"/> Floor Sink: <input type="text"/> Plumbing Remarks: <input type="text"/>	Other Fixtures: <input type="checkbox"/> Shower <input type="checkbox"/> Eyewash Station <input type="checkbox"/> Tub <input type="checkbox"/> Eyewash/Shower Station <input type="checkbox"/> Ice Maker <input type="checkbox"/> Emergency Shower <input type="checkbox"/> Water Closet <input type="checkbox"/> Flush Rim Sink <input type="checkbox"/> Instantaneous Hot Water <input type="checkbox"/> Floor Drain <input type="checkbox"/> <input type="checkbox"/> Water Bottle Refill Station Other: <input type="text"/>	<b>MED / NON-MED GASES</b> (Quantity) Oxygen: <input type="text"/> Medical Air: <input type="text"/> Medical Vacuum: <input type="text"/> Nitrous Oxide: <input type="text"/> CO2: <input type="text"/> AGSS: <input type="text"/> Nitrogen: <input type="text"/> Laboratory Air: <input type="text"/> Laboratory Vacuum: <input type="text"/> Utility Compressed Air: <input type="text"/> Gas Remarks: <input type="text"/>
---	---	---

---

# New Surrey Hospital & BC Cancer Centre

MINIMUM ROOM REQUIREMENTS

## M. Functional Imaging

---

**Appendix 1B Minimum Room Requirements**

Room Name:

Program Number(s):

1.	M1.25	7.		13.		19.		25.		31.		37.		43.
2.		8.		14.		20.		26.		32.		38.		44.
3.		9.		15.		21.		27.		33.		39.		45.
4.		10.		16.		22.		28.		34.		40.		46.
5.		11.		17.		23.		29.		35.		41.		47.
6.		12.		18.		24.		30.		36.		42.		48.

**ARCHITECTURAL REQUIREMENTS**

<b>WALL AND CEILING</b> Wall Material: <input type="text" value="ARGB 1.2m AFF, GB above"/> Finish: <input type="text" value="EWC"/> Ceiling Material: <input type="text" value="ACT-C"/> Finish: <input type="text" value="PF"/>	<b>WALL PROTECTION</b> Type: <input type="text" value="PVW"/> <input checked="" type="checkbox"/> Corner Guards <input type="checkbox"/> Hand Rails <input type="checkbox"/> Bed Bumper / Locator Height: <input type="text" value="2185 mm"/> <input type="checkbox"/> Crash Rails <input type="checkbox"/> Chair Rail	<b>GLAZING</b> <input type="checkbox"/> Interior Glazing	<b>FLOORING TYPES</b> Material: <input type="text" value="VSF"/> Base: <input type="text" value="FCB"/>	<b>ROOM ACCESSORIES</b> <input checked="" type="checkbox"/> Coat Hooks <input type="checkbox"/> Ceiling Lift <input type="checkbox"/> Magnetic Whiteboard <input checked="" type="checkbox"/> Mirror <input type="checkbox"/> Infant Change Table <input type="checkbox"/> Privacy Curtain
---	---	---	--	--

- LEGEND:**
- WALL AND CEILING LEGEND:**
- AC Architectural Ceiling
  - ACT Acoustic Ceiling Tile
  - ACT-C Cleanroom
  - ARGB Abuse-Resistant Gypsum Board
  - GB Gypsum Board
  - IRGB Impact-Resistant Gypsum Board
  - KLCT Kitchen Lay-in Ceiling Tile
  - MMRGB Moisture and Mould-Resistant Gypsum Board
  - SACT Security Acoustic Ceiling Tile
- WALL FINISHES LEGEND:**
- EWC Epoxy Wall Coating
  - HPC High Performance Coating
  - PT Paint
- CEILING FINISHES LEGEND:**
- ECC Epoxy Ceiling Coating
  - HPC High Performance Coating
  - PF Prefinished
  - PT Paint
- WALL PROTECTION LEGEND:**
- ESRP Extruded Semi-Rigid PVCu Panel
  - FRL Fibre Reinforced Laminata
  - FRP Fibreglass Reinforced Plastic
  - PVW Protective Vinyl Wallcovering
  - RHIS Rigid High Impact Sheet
  - WSSP Wetwall Solid Surface Panel
  - WWW Wetroom Vinyl Wallcovering
- FLOOR FINISHES LEGEND:**
- CFS Concrete Floor Sealer
  - EFC Epoxy Floor Coating
  - PFC Polyurethane Floor Coating
  - RAF Rubber Athletic Flooring
  - RSF Rubber Sheet Flooring
  - SCF Seamless Cushioned Flooring
  - SDRF Static-Dissipative Rubber Sheet Flooring
  - SDVF Static-Dissipative Vinyl Sheet Flooring
  - VSF Vinyl Sheet Flooring
  - WSVF Wetroom Safety Vinyl Sheet Flooring
- FLOOR BASE LEGEND:**
- FCB Flash Cove Base
  - RB Rubber Base
  - SCF Seamless Cushioned Flooring

**DOORS**

Types:

Type	Qty	Size (mm)	Material	Finish	Side Lt.	Blinds	Protect.	Privacy Film	Function	Card Reader	Mag Lock	Auto Opener	Hold Open	Hinges	Accessory 1	Accessory 2	Accessory 3	Closer
C	2	915 x 2135	Solid Core	FRL	<input type="checkbox"/>	<input type="checkbox"/>	2 High	<input type="checkbox"/>	Push/Pull	<input type="checkbox"/>	<input checked="" type="checkbox"/>	<input checked="" type="checkbox"/>	<input checked="" type="checkbox"/>	Butt Hinge	Elec. Strike			Concealed

**Door Remarks:**  
 Interlock M1.25 Airlock door entering M1.38 Gowning Room to M1.27 Small Clean Room door and both M1.26 Clean Room doors. All three doors entering the clean rooms can only open once the airlock door is closed or upon pressing an override button.

Security Grille  
 Anti-barricade strategy

**MILLWORK AND SPECIALTY CASEWORK**

Storage Requirements:

**UPPER UNITS**  
 U1  U2  U3  U4  U5  U6  U7  U8

**LOWER UNITS**  
 L1  L2  L3  L4  L5  L6  L7  L8  L9  L10  L11  L12

**FULL-HEIGHT CABINETS**  
 C1  C2  C3  C4  C5

**RECEPTION/TRANSACTION COUNTER / CARE TEAM STATION DESK**  
 TC1  TC2

**UTILITY SINK AND COUNTER UNIT**  
 UC1

**SHELF**  
 S1

**Legend:**  
 Category 0 - None  
 Category 1 - Low (1% - 4%)  
 Category 2 - Med (5% - 9%)  
 Category 3 - High (10% or Greater)

Category	Min. Length (mm)	Motorized Adjustable Height	Standing Height	Specialty Casework
3	3900	<input type="checkbox"/>	<input type="checkbox"/>	<input checked="" type="checkbox"/>

**FINISHES**

Full-height Cabinet:   
 Upper Millwork:   
 Countertop:   
 Lower Millwork:   
 Shelf:

**Remarks:**  
 Refer to Schedule 1, Section 6.12 (Division 12) for Specialty Casework. Items indicated are diagrammatic, provide specialty casework appropriate for the specific and specialized functions to be performed in the space and to accommodate Equipment. Provide storage/shelving for equipment and supplies. Provide powder coated finish for chambers.

**MECHANICAL REQUIREMENTS**

<b>PLUMBING</b> (Quantity) Hand Hygiene Sink: <input type="text" value="1"/> Lavatory: <input type="text"/> Kitchen Sink: <input type="text"/> Seamless Kitchen Sink: <input type="text"/> Utility / Process Sink: <input type="text" value="1"/> Scrub Sink: <input type="text"/> Floor Sink: <input type="text"/> Plumbing Remarks: <input type="text"/>	Other Fixtures: <input type="checkbox"/> Shower <input type="checkbox"/> Tub <input type="checkbox"/> Ice Maker <input type="checkbox"/> Water Closet <input type="checkbox"/> Instantaneous Hot Water <input type="checkbox"/> Eyewash Station <input type="checkbox"/> Eyewash/Shower Station <input type="checkbox"/> Emergency Shower <input type="checkbox"/> Flush Rim Sink <input type="checkbox"/> Floor Drain <input type="checkbox"/> Water Bottle Refill Station Other: <input type="text"/>	<b>MED / NON-MED GASES</b> (Quantity) Oxygen: <input type="text"/> Medical Air: <input type="text"/> Medical Vacuum: <input type="text"/> Nitrous Oxide: <input type="text"/> CO2: <input type="text"/> AGSS: <input type="text"/> Nitrogen: <input type="text"/> Laboratory Air: <input type="text"/> Laboratory Vacuum: <input type="text"/> Utility Compressed Air: <input type="text"/> Gas Remarks: <input type="text"/>
---	---	---



# Appendix 1B Minimum Room Requirements

Room Name:

Program Number(s):

1.	M1.13	7.		13.		19.		25.		31.		37.		43.
2.		8.		14.		20.		26.		32.		38.		44.
3.		9.		15.		21.		27.		33.		39.		45.
4.		10.		16.		22.		28.		34.		40.		46.
5.		11.		17.		23.		29.		35.		41.		47.
6.		12.		18.		24.		30.		36.		42.		48.

## ARCHITECTURAL REQUIREMENTS

<b>WALL AND CEILING</b> Wall Material: <input type="text" value="ARGB 1.2m AFF, GB above"/> Finish: <input type="text" value="PT"/> Ceiling Material: <input type="text" value="ACT-C"/> Finish: <input type="text" value="PF"/>		<b>WALL PROTECTION</b> Type: <input type="text" value="ESRP"/> <input checked="" type="checkbox"/> Corner Guards <input type="checkbox"/> Hand Rails <input type="checkbox"/> Bed Bumper / Locator Height: <input type="text" value="2185 mm"/> <input type="checkbox"/> Crash Rails <input type="checkbox"/> Chair Rail			<b>GLAZING</b> <input type="checkbox"/> Interior Glazing		<b>FLOORING TYPES</b> Material: <input type="text" value="VSF"/> Base: <input type="text" value="FCB"/>		<b>ROOM ACCESSORIES</b> <input checked="" type="checkbox"/> Coat Hooks <input type="checkbox"/> Ceiling Lift <input checked="" type="checkbox"/> Magnetic Whiteboard <input type="checkbox"/> Mirror <input type="checkbox"/> Infant Change Table <input type="checkbox"/> Privacy Curtain		
--	--	--	--	--	---	--	--	--	--	--	--

- LEGEND:**
- WALL AND CEILING LEGEND:**
- AC Architectural Ceiling
  - ACT Acoustic Ceiling Tile
  - ACT-C Cleanroom
  - ARGB Abuse-Resistant Gypsum Board
  - GB Gypsum Board
  - IRGB Impact-Resistant Gypsum Board
  - KLCT Kitchen Lay-in Ceiling Tile
  - MMRGB Moisture and Mould-Resistant Gypsum Board
  - SACT Security Acoustic Ceiling Tile
- WALL FINISHES LEGEND:**
- EWC Epoxy Wall Coating
  - HPC High Performance Coating
  - PT Paint
- CEILING FINISHES LEGEND:**
- ECC Epoxy Ceiling Coating
  - HPC High Performance Coating
  - PF Prefinished
  - PT Paint
- WALL PROTECTION LEGEND:**
- ESRP Extruded Semi-Rigid PVCu Panel
  - FRL Fibre Reinforced Laminate
  - FRP Fibreglass Reinforced Plastic
  - PVV Protective Vinyl Wallcovering
  - RHIS Rigid High Impact Sheet
  - WSSP Wetwall Solid Surface Panel
  - WVV Wetroom Vinyl Wallcovering
- FLOOR FINISHES LEGEND:**
- CFS Concrete Floor Sealer
  - EFC Epoxy Floor Coating
  - PFC Polyurethane Floor Coating
  - RAF Rubber Athletic Flooring
  - RSF Rubber Sheet Flooring
  - SCF Seamless Cushioned Flooring
  - SDRF Static-Dissipative Rubber Sheet Flooring
  - SDVF Static-Dissipative Vinyl Sheet Flooring
  - VSF Vinyl Sheet Flooring
  - WSVF Wetroom Safety Vinyl Sheet Flooring
- FLOOR BASE LEGEND:**
- FCB Flash Cove Base
  - RB Rubber Base
  - SCF Seamless Cushioned Flooring

**DOORS**

Types:

Note: for Type F doors, the door panels will be approximately 465/1065 unless otherwise required by the Authority

Type	Qty	Size (mm)	Material	Finish	Side Lt.	Blinds	Protect.	Privacy Film	Function	Card Reader	Mag Lock	Auto Opener	Hold Open	Hinges	Accessory 1	Accessory 2	Accessory 3	Closer
F2	2	1830 x 2135	Solid Core	FRL	<input type="checkbox"/>	<input type="checkbox"/>	2 High	<input type="checkbox"/>	Push/Pull	<input checked="" type="checkbox"/>	<input checked="" type="checkbox"/>	<input type="checkbox"/>	<input type="checkbox"/>	Butt Hinge	Astragal	Flush Bolt	Elec. Strike	Concealed



## MECHANICAL REQUIREMENTS

<b>PLUMBING</b> (Quantity) Hand Hygiene Sink: <input type="text"/> Lavatory: <input type="text"/> Kitchen Sink: <input type="text"/> Seamless Kitchen Sink: <input type="text"/> Utility / Process Sink: <input type="text"/> Scrub Sink: <input type="text"/> Floor Sink: <input type="text"/>							Other Fixtures: <input type="checkbox"/> Shower <input type="checkbox"/> Eyewash Station <input type="checkbox"/> Tub <input type="checkbox"/> Eyewash/Shower Station <input type="checkbox"/> Ice Maker <input type="checkbox"/> Emergency Shower <input type="checkbox"/> Water Closet <input type="checkbox"/> Flush Rim Sink <input type="checkbox"/> Instantaneous Hot Water <input type="checkbox"/> Floor Drain <input type="checkbox"/> Water Bottle Refill Station Other: <input type="text"/>				<b>MED / NON-MED GASES</b> (Quantity) Oxygen: <input type="text"/> Medical Air: <input type="text"/> Medical Vacuum: <input type="text"/> Nitrous Oxide: <input type="text"/> CO2: <input type="text"/> AGSS: <input type="text"/> Nitrogen: <input type="text"/> Laboratory Air: <input type="text"/> Laboratory Vacuum: <input type="text"/> Utility Compressed Air: <input type="text"/>					
Plumbing Remarks: <input type="text"/>											Gas Remarks: <input type="text"/>					

**Appendix 1B Minimum Room Requirements**

Room Name:

Program Number(s):

1. M1.16	7.	13.	19.	25.	31.	37.	43.
2.	8.	14.	20.	26.	32.	38.	44.
3.	9.	15.	21.	27.	33.	39.	45.
4.	10.	16.	22.	28.	34.	40.	46.
5.	11.	17.	23.	29.	35.	41.	47.
6.	12.	18.	24.	30.	36.	42.	48.

**ARCHITECTURAL REQUIREMENTS**

<b>WALL AND CEILING</b> Wall Material: <input type="text" value="ARGB 1.2m AFF, GB above"/> Finish: <input type="text" value="HPC"/> Ceiling Material: <input type="text" value="ACT-C"/> Finish: <input type="text" value="PF"/>	<b>WALL PROTECTION</b> Type: <input type="text" value="FRP"/> <input checked="" type="checkbox"/> Corner Guards <input type="checkbox"/> Hand Rails <input type="checkbox"/> Bed Bumper / Locator Height: <input type="text" value="1600 mm"/> <input type="checkbox"/> Crash Rails <input type="checkbox"/> Chair Rail	<b>GLAZING</b> <input type="checkbox"/> Interior Glazing	<b>FLOORING TYPES</b> Material: <input type="text" value="PFC"/> Base: <input type="text" value="FCB"/>	<b>ROOM ACCESSORIES</b> <input checked="" type="checkbox"/> Coat Hooks <input type="checkbox"/> Ceiling Lift <input type="checkbox"/> Magnetic Whiteboard <input type="checkbox"/> Mirror <input type="checkbox"/> Infant Change Table <input type="checkbox"/> Privacy Curtain
---	---	---	--	---

- LEGEND:**
- WALL AND CEILING LEGEND:**
- AC Architectural Ceiling
  - ACT Acoustic Ceiling Tile
  - ACT-C Cleanroom
  - ARGB Abuse-Resistant Gypsum Board
  - GB Gypsum Board
  - IRGB Impact-Resistant Gypsum Board
  - KLCT Kitchen Lay-in Ceiling Tile
  - MMRGB Moisture and Mould-Resistant Gypsum Board
  - SACT Security Acoustic Ceiling Tile
- WALL FINISHES LEGEND:**
- EWC Epoxy Wall Coating
  - HPC High Performance Coating
  - PT Paint
- CEILING FINISHES LEGEND:**
- ECC Epoxy Ceiling Coating
  - HPC High Performance Coating
  - PF Prefinished
  - PT Paint
- WALL PROTECTION LEGEND:**
- ESRP Extruded Semi-Rigid PVCu Panel
  - FRL Fibre Reinforced Laminata
  - FRP Fibreglass Reinforced Plastic
  - PVV Protective Vinyl Wallcovering
  - RHIS Rigid High Impact Sheet
  - WSSP Wetwall Solid Surface Panel
  - WWW Wetroom Vinyl Wallcovering
- FLOOR FINISHES LEGEND:**
- CFS Concrete Floor Sealer
  - EFC Epoxy Floor Coating
  - PFC Polyurethane Floor Coating
  - RAF Rubber Athletic Flooring
  - RSF Rubber Sheet Flooring
  - SCF Seamless Cushioned Flooring
  - SDRF Static-Dissipative Rubber Sheet Flooring
  - SDVF Static-Dissipative Vinyl Sheet Flooring
  - VSF Vinyl Sheet Flooring
  - WSVF Wetroom Safety Vinyl Sheet Flooring
- FLOOR BASE LEGEND:**
- FCB Flash Cove Base
  - RB Rubber Base
  - SCF Seamless Cushioned Flooring

**DOORS**

Types:

Type	Qty	Size (mm)	Material	Finish	Side Lt.	Blinds	Protect.	Privacy Film	Function	Card Reader	Mag Lock	Auto Opener	Hold Open	Hinges	Accessory 1	Accessory 2	Accessory 3	Closer
C	1	915 x 2135	Solid Core	FRL	<input type="checkbox"/>	<input type="checkbox"/>	2 High	<input type="checkbox"/>	Passage	<input type="checkbox"/>	<input type="checkbox"/>	<input checked="" type="checkbox"/>	<input type="checkbox"/>	Butt Hinge	Elec. Strike			Surface

Door Remarks:  Security Grille  Anti-barricade strategy

**MILLWORK AND SPECIALTY CASEWORK**

Storage Requirements:

**UPPER UNITS**

- U1
- U2
- U3
- U4
- U5
- U6
- U7
- U8

**LOWER UNITS**

- L1
- L2
- L3
- L4
- L5
- L6
- L7
- L8
- L9
- L10
- L11
- L12

**RECEPTION/TRANSACTION COUNTER / CARE TEAM STATION DESK**

- TC1
- TC2

**UTILITY SINK AND COUNTER UNIT**

- UC1

**FULL-HEIGHT CABINETS**

- C1
- C2
- C3
- C4
- C5

**Legend:**

Category	Min. Length (mm)	Motorized Adjustable Height	Standing Height	Specialty Casework
3	2700	<input type="checkbox"/>	<input checked="" type="checkbox"/>	<input checked="" type="checkbox"/>

**FINISHES**

Full-height Cabinet:

Upper Millwork:

Countertop:

Lower Millwork:

Shelf:

Remarks: Refer to Schedule 1, Section 6.12 (Division 12) for Specialty Casework. Items indicated are diagrammatic, provide specialty casework appropriate for the specific and specialized functions to be performed in the space and to accommodate Equipment. Provide powder coated finish for casework.

**MECHANICAL REQUIREMENTS**

<b>PLUMBING</b> (Quantity) Hand Hygiene Sink: <input type="text"/> Lavatory: <input type="text"/> Kitchen Sink: <input type="text"/> Seamless Kitchen Sink: <input type="text"/> Utility / Process Sink: <input type="text" value="2"/> Scrub Sink: <input type="text"/> Floor Sink: <input type="text"/> Plumbing Remarks: <input type="text"/>	Other Fixtures: <input type="checkbox"/> Shower <input type="checkbox"/> Eyewash Station <input type="checkbox"/> Tub <input type="checkbox"/> Eyewash/Shower Station <input type="checkbox"/> Ice Maker <input type="checkbox"/> Emergency Shower <input type="checkbox"/> Water Closet <input checked="" type="checkbox"/> Floor Drain <input type="checkbox"/> Instantaneous Hot Water <input type="checkbox"/> Water Bottle Refill Station Other: <input type="text"/>	<b>MED / NON-MED GASES</b> (Quantity) Oxygen: <input type="text"/> Medical Air: <input type="text"/> Medical Vacuum: <input type="text"/> Nitrous Oxide: <input type="text"/> CO2: <input type="text"/> AGSS: <input type="text"/> Nitrogen: <input type="text"/> Laboratory Air: <input type="text" value="1"/> Laboratory Vacuum: <input type="text"/> Utility Compressed Air: <input type="text"/> Gas Remarks: Provide the following gasses. CA, H2, N2, He, Ar, Ar + 10% Me. Provide (2) benchtop fume hoods
---	--	---

**Appendix 1B Minimum Room Requirements**

Room Name:

Program Number(s):

1. M1.26	7.	13.	19.	25.	31.	37.	43.
2.	8.	14.	20.	26.	32.	38.	44.
3.	9.	15.	21.	27.	33.	39.	45.
4.	10.	16.	22.	28.	34.	40.	46.
5.	11.	17.	23.	29.	35.	41.	47.
6.	12.	18.	24.	30.	36.	42.	48.

**ARCHITECTURAL REQUIREMENTS**

<b>WALL AND CEILING</b> Wall Material: <input type="text" value="ARGB 1.2m AFF, GB above"/> Finish: <input type="text" value="EWC"/> Ceiling Material: <input type="text" value="GB"/> Finish: <input type="text" value="ECC"/>	<b>WALL PROTECTION</b> Type: <input type="text" value="ESRP"/> <input checked="" type="checkbox"/> Corner Guards <input type="checkbox"/> Hand Rails <input type="checkbox"/> Bed Bumper / Locator Height: <input type="text" value="2185 mm"/> <input type="checkbox"/> Crash Rails <input type="checkbox"/> Chair Rail	<b>GLAZING</b> <input type="checkbox"/> Interior Glazing	<b>FLOORING TYPES</b> Material: <input type="text" value="RSF"/> Base: <input type="text" value="FCB"/>	<b>ROOM ACCESSORIES</b> <input type="checkbox"/> Coat Hooks <input type="checkbox"/> Ceiling Lift <input type="checkbox"/> Magnetic Whiteboard <input type="checkbox"/> Mirror <input type="checkbox"/> Infant Change Table <input type="checkbox"/> Privacy Curtain
---	--	---	--	--

- LEGEND:**
- WALL AND CEILING LEGEND:**
- AC Architectural Ceiling
  - ACT Acoustic Ceiling Tile
  - ACT-C Cleanroom
  - ARGB Abuse-Resistant Gypsum Board
  - GB Gypsum Board
  - IRGB Impact-Resistant Gypsum Board
  - KLCT Kitchen Lay-in Ceiling Tile
  - MMRGB Moisture and Mould-Resistant Gypsum Board
  - SACT Security Acoustic Ceiling Tile
- WALL FINISHES LEGEND:**
- EWC Epoxy Wall Coating
  - HPC High Performance Coating
  - PT Paint
- CEILING FINISHES LEGEND:**
- ECC Epoxy Ceiling Coating
  - HPC High Performance Coating
  - PF Prefinished
  - PT Paint
- WALL PROTECTION LEGEND:**
- ESRP Extruded Semi-Rigid PVCu Panel
  - FRL Fibre Reinforced Laminate
  - FRP Fibreglass Reinforced Plastic
  - PVV Protective Vinyl Wallcovering
  - RHIS Rigid High Impact Sheet
  - WSSP Wetwall Solid Surface Panel
  - WVV Wetroom Vinyl Wallcovering
- FLOOR FINISHES LEGEND:**
- CFS Concrete Floor Sealer
  - EFC Epoxy Floor Coating
  - PFC Polyurethane Floor Coating
  - RAF Rubber Athletic Flooring
  - RSF Rubber Sheet Flooring
  - SCF Seamless Cushioned Flooring
  - SDRF Static-Dissipative Rubber Sheet Flooring
  - SDVF Static-Dissipative Vinyl Sheet Flooring
  - VSF Vinyl Sheet Flooring
  - WSVF Wetroom Safety Vinyl Sheet Flooring
- FLOOR BASE LEGEND:**
- FCB Flash Cove Base
  - RB Rubber Base
  - SCF Seamless Cushioned Flooring

**DOORS**

Types:

Type	Qty	Size (mm)	Material	Finish	Side Lt.	Blinds	Protect.	Privacy Film	Function	Card Reader	Mag Lock	Auto Opener	Hold Open	Hinges	Accessory 1	Accessory 2	Accessory 3	Closer
C	1	915 x 2135	Cleanroom	Prefinished	<input type="checkbox"/>	<input type="checkbox"/>	2 High	<input type="checkbox"/>	Passage	<input type="checkbox"/>	<input checked="" type="checkbox"/>	<input checked="" type="checkbox"/>	<input type="checkbox"/>	Butt Hinge	Elec. Strike			Concealed

Door Remarks:  Security Grille  Anti-barricade strategy

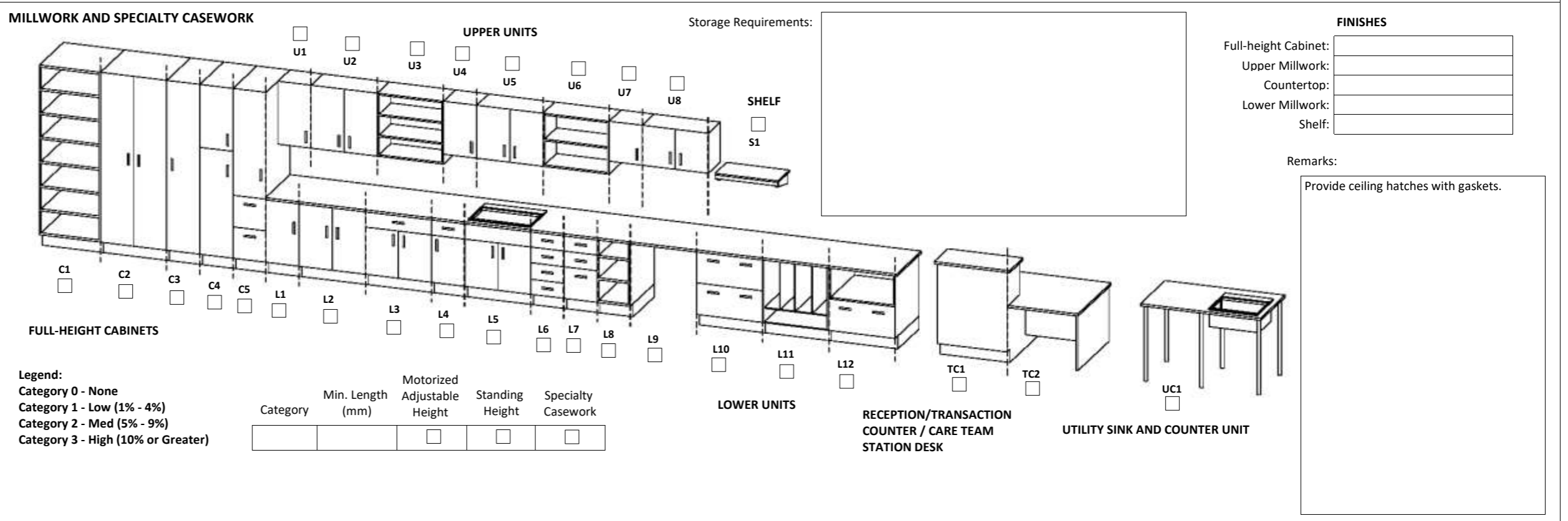

**MECHANICAL REQUIREMENTS**

<b>PLUMBING</b> (Quantity) Hand Hygiene Sink: <input type="text"/> Lavatory: <input type="text"/> Kitchen Sink: <input type="text"/> Kitchen Sink: <input type="text"/> Utility / Process Sink: <input type="text"/> Scrub Sink: <input type="text"/> Floor Sink: <input type="text"/> Plumbing Remarks: <input type="text" value="Provide floor drain in trench located in service area behind hot cells that serve the clean room."/>	Other Fixtures: <input type="checkbox"/> Shower <input type="checkbox"/> Eyewash Station <input type="checkbox"/> Tub <input type="checkbox"/> Eyewash/Shower Station <input type="checkbox"/> Ice Maker <input type="checkbox"/> Emergency Shower <input type="checkbox"/> Water Closet <input checked="" type="checkbox"/> Floor Drain <input type="checkbox"/> Instantaneous Hot Water <input type="checkbox"/> Water Bottle Refill Station Other: <input type="text"/>	<b>MED / NON-MED GASES</b> (Quantity) Oxygen: <input type="text"/> Medical Air: <input type="text"/> Medical Vacuum: <input type="text"/> Nitrous Oxide: <input type="text"/> CO2: <input type="text"/> AGSS: <input type="text"/> Nitrogen: <input type="text"/> Laboratory Air: <input type="text" value="1"/> Laboratory Vacuum: <input type="text"/> Utility Compressed Air: <input type="text"/> Gas Remarks: <input type="text" value="Hot cell serving clean room requires the following gas connections. CA, N2, H3, Ar. Clean rooms will be tied to CA vacuum piped system for radioactive release decay mode."/>
--	--	--



**Appendix 1B Minimum Room Requirements**

Room Name:

Program Number(s):

1.	M2.24	7.		13.		19.		25.		31.		37.		43.
2.		8.		14.		20.		26.		32.		38.		44.
3.		9.		15.		21.		27.		33.		39.		45.
4.		10.		16.		22.		28.		34.		40.		46.
5.		11.		17.		23.		29.		35.		41.		47.
6.		12.		18.		24.		30.		36.		42.		48.

**ARCHITECTURAL REQUIREMENTS**

<b>WALL AND CEILING</b> Wall Material: <input type="text" value="ARGB 1.2m AFF, GB above"/> Finish: <input type="text" value="PT"/> Ceiling Material: <input type="text" value="ACT"/> Finish: <input type="text" value="PF"/>	<b>WALL PROTECTION</b> Type: <input type="text" value="RHIS"/> <input checked="" type="checkbox"/> Corner Guards <input type="checkbox"/> Hand Rails <input type="checkbox"/> Bed Bumper / Locator Height: <input type="text" value="1350 mm"/> <input type="checkbox"/> Crash Rails <input checked="" type="checkbox"/> Chair Rail	<b>GLAZING</b> <input type="checkbox"/> Interior Glazing	<b>FLOORING TYPES</b> Material: <input type="text" value="VSF"/> Base: <input type="text" value="FCB"/>	<b>ROOM ACCESSORIES</b> <input type="checkbox"/> Coat Hooks <input type="checkbox"/> Ceiling Lift <input type="checkbox"/> Magnetic Whiteboard <input type="checkbox"/> Mirror <input type="checkbox"/> Infant Change Table <input type="checkbox"/> Privacy Curtain
--	---	---	--	--

- LEGEND:**
- WALL AND CEILING LEGEND:**
- AC Architectural Ceiling
  - ACT Acoustic Ceiling Tile
  - ACT-C Cleanroom
  - ARGB Abuse-Resistant Gypsum Board
  - GB Gypsum Board
  - IRGB Impact-Resistant Gypsum Board
  - KLCT Kitchen Lay-in Ceiling Tile
  - MMRGB Moisture and Mould-Resistant Gypsum Board
  - SACT Security Acoustic Ceiling Tile
- WALL FINISHES LEGEND:**
- EWC Epoxy Wall Coating
  - HPC High Performance Coating
  - PT Paint
- CEILING FINISHES LEGEND:**
- ECC Epoxy Ceiling Coating
  - HPC High Performance Coating
  - PF Prefinished
  - PT Paint
- WALL PROTECTION LEGEND:**
- ESRP Extruded Semi-Rigid PVCu Panel
  - FRL Fibre Reinforced Laminat
  - FRP Fibreglass Reinforced Plastic
  - PVV Protective Vinyl Wallcovering
  - RHIS Rigid High Impact Sheet
  - WSSP Wetwall Solid Surface Panel
  - WVV Wetroom Vinyl Wallcovering
- FLOOR FINISHES LEGEND:**
- CFS Concrete Floor Sealer
  - EFC Epoxy Floor Coating
  - PFC Polyurethane Floor Coating
  - RAF Rubber Athletic Flooring
  - RSF Rubber Sheet Flooring
  - SCF Seamless Cushioned Flooring
  - SDRF Static-Dissipative Rubber Sheet Flooring
  - SDVF Static-Dissipative Vinyl Sheet Flooring
  - VSF Vinyl Sheet Flooring
  - WSVF Wetroom Safety Vinyl Sheet Flooring
- FLOOR BASE LEGEND:**
- FCB Flash Cove Base
  - RB Rubber Base
  - SCF Seamless Cushioned Flooring

**DOORS**

Types:

Type	Qty	Size (mm)	Material	Finish	Side Lt	Blinds	Protect	Privacy Film	Function	Card Reader	Mag Lock	Auto Opener	Hold Open	Hinges	Accessory 1	Accessory 2	Accessory 3	Closer
C	1	1065 x 2135	Solid Core	FRL	<input type="checkbox"/>	<input type="checkbox"/>	1 Low	<input type="checkbox"/>	Storeroom	<input checked="" type="checkbox"/>	<input type="checkbox"/>	<input type="checkbox"/>	<input type="checkbox"/>	Butt Hinge				Surface

Door Remarks:  Security Grille  Anti-barricade strategy



**MECHANICAL REQUIREMENTS**

<b>PLUMBING</b> (Quantity) Hand Hygiene Sink: <input type="text"/> Lavatory: <input type="text"/> Kitchen Sink: <input type="text"/> Seamless Kitchen Sink: <input type="text"/> Utility / Process Sink: <input type="text"/> Scrub Sink: <input type="text"/> Floor Sink: <input type="text"/> Plumbing Remarks: <input type="text"/>	Other Fixtures: <input type="checkbox"/> Shower <input type="checkbox"/> Eyewash Station <input type="checkbox"/> Tub <input type="checkbox"/> Eyewash/Shower Station <input type="checkbox"/> Ice Maker <input type="checkbox"/> Emergency Shower <input type="checkbox"/> Water Closet <input type="checkbox"/> Flush Rim Sink <input type="checkbox"/> Instantaneous Hot Water <input type="checkbox"/> Floor Drain <input type="checkbox"/> <input type="checkbox"/> Water Bottle Refill Station Other: <input type="text"/>	<b>MED / NON-MED GASES</b> (Quantity) Oxygen: <input type="text"/> Medical Air: <input type="text"/> Medical Vacuum: <input type="text"/> Nitrous Oxide: <input type="text"/> CO2: <input type="text"/> AGSS: <input type="text"/> Nitrogen: <input type="text"/> Laboratory Air: <input type="text"/> Laboratory Vacuum: <input type="text"/> Utility Compressed Air: <input type="text"/> Gas Remarks: <input type="text"/>
---	---	---

# Appendix 1B Minimum Room Requirements

Room Name:

Program Number(s):

1.	M1.28	7.		13.		19.		25.		31.		37.		43.
2.		8.		14.		20.		26.		32.		38.		44.
3.		9.		15.		21.		27.		33.		39.		45.
4.		10.		16.		22.		28.		34.		40.		46.
5.		11.		17.		23.		29.		35.		41.		47.
6.		12.		18.		24.		30.		36.		42.		48.

## ARCHITECTURAL REQUIREMENTS

<b>WALL AND CEILING</b> Wall Material: <input type="text" value="ARGB 1.2m AFF, GB above"/> Finish: <input type="text" value="PT"/> Ceiling Material: <input type="text" value="ACT"/> Finish: <input type="text" value="PF"/>		<b>WALL PROTECTION</b> Type: <input type="text" value="FRP"/> <input checked="" type="checkbox"/> Corner Guards <input type="checkbox"/> Hand Rails <input type="checkbox"/> Bed Bumper / Locator Height: <input type="text" value="1600 mm"/> <input type="checkbox"/> Crash Rails <input checked="" type="checkbox"/> Chair Rail			<b>GLAZING</b> <input type="checkbox"/> Interior Glazing		<b>FLOORING TYPES</b> Material: <input type="text" value="SDVF"/> Base: <input type="text" value="FCB"/>		<b>ROOM ACCESSORIES</b> <input type="checkbox"/> Coat Hooks <input type="checkbox"/> Ceiling Lift <input checked="" type="checkbox"/> Magnetic Whiteboard <input type="checkbox"/> Mirror <input type="checkbox"/> Infant Change Table <input type="checkbox"/> Privacy Curtain		
--	--	--	--	--	---	--	---	--	---	--	--

- LEGEND:**
- WALL AND CEILING LEGEND:**
- AC Architectural Ceiling
  - ACT Acoustic Ceiling Tile
  - ACT-C Cleanroom
  - ARGB Abuse-Resistant Gypsum Board
  - GB Gypsum Board
  - IRGB Impact-Resistant Gypsum Board
  - KLCT Kitchen Lay-in Ceiling Tile
  - MMRGB Moisture and Mould-Resistant Gypsum Board
  - SACT Security Acoustic Ceiling Tile
- WALL FINISHES LEGEND:**
- EWC Epoxy Wall Coating
  - HPC High Performance Coating
  - PT Paint
- CEILING FINISHES LEGEND:**
- ECC Epoxy Ceiling Coating
  - HPC High Performance Coating
  - PF Prefinished
  - PT Paint
- WALL PROTECTION LEGEND:**
- ESRP Extruded Semi-Rigid PVCu Panel
  - FRL Fibre Reinforced Laminate
  - FRP Fibreglass Reinforced Plastic
  - PVV Protective Vinyl Wallcovering
  - RHIS Rigid High Impact Sheet
  - WSSP Wetwall Solid Surface Panel
  - WVV Wetroom Vinyl Wallcovering
- FLOOR FINISHES LEGEND:**
- CFS Concrete Floor Sealer
  - EFC Epoxy Floor Coating
  - PFC Polyurethane Floor Coating
  - RAF Rubber Athletic Flooring
  - RSF Rubber Sheet Flooring
  - SCF Seamless Cushioned Flooring
  - SDRF Static-Dissipative Rubber Sheet Flooring
  - SDVF Static-Dissipative Vinyl Sheet Flooring
  - VSF Vinyl Sheet Flooring
  - WSVF Wetroom Safety Vinyl Sheet Flooring
- FLOOR BASE LEGEND:**
- FCB Flash Cove Base
  - RB Rubber Base
  - SCF Seamless Cushioned Flooring

**DOORS**

Types:

Type	Qty	Size (mm)	Material	Finish	Side Lt.	Blinds	Protect.	Privacy Film	Function	Card Reader	Mag Lock	Auto Opener	Hold Open	Hinges	Accessory 1	Accessory 2	Accessory 3	Closer
C	1	1065 x 2135	Solid Core	FRL	<input type="checkbox"/>	<input type="checkbox"/>	1 Low	<input type="checkbox"/>	Passage	<input type="checkbox"/>	<input type="checkbox"/>	<input type="checkbox"/>	<input type="checkbox"/>	Butt Hinge				Surface

Door Remarks:  Security Grille  Anti-barricade strategy

**MILLWORK AND SPECIALTY CASEWORK**

**UPPER UNITS** (U1-U8) **LOWER UNITS** (L1-L9) **SHELF** (S1) **RECEPTION/TRANSACTION COUNTER / CARE TEAM STATION DESK** (TC1, TC2) **UTILITY SINK AND COUNTER UNIT** (UC1)

Storage Requirements:

**FINISHES**

Full-height Cabinet:   
 Upper Millwork:   
 Countertop:   
 Lower Millwork:   
 Shelf:

Remarks:

Category	Min. Length (mm)	Motorized Adjustable Height	Standing Height	Specialty Casework
3	2700	<input type="checkbox"/>	<input type="checkbox"/>	<input type="checkbox"/>

## MECHANICAL REQUIREMENTS

<b>PLUMBING</b> (Quantity) Hand Hygiene Sink: <input type="text"/> Lavatory: <input type="text"/> Kitchen Sink: <input type="text"/> Seamless Kitchen Sink: <input type="text"/> Utility / Process Sink: <input type="text"/> Scrub Sink: <input type="text"/> Floor Sink: <input type="text"/>							Other Fixtures: <input type="checkbox"/> Shower <input type="checkbox"/> Tub <input type="checkbox"/> Ice Maker <input type="checkbox"/> Water Closet <input type="checkbox"/> Instantaneous Hot Water <input type="checkbox"/> Eyewash Station <input type="checkbox"/> Eyewash/Shower Station <input type="checkbox"/> Emergency Shower <input type="checkbox"/> Flush Rim Sink <input type="checkbox"/> Floor Drain <input type="checkbox"/> Water Bottle Refill Station Other: <input type="text"/>				<b>MED / NON-MED GASES</b> (Quantity) Oxygen: <input type="text"/> Medical Air: <input type="text"/> Medical Vacuum: <input type="text"/> Nitrous Oxide: <input type="text"/> CO2: <input type="text"/> AGSS: <input type="text"/> Nitrogen: <input type="text"/> Laboratory Air: <input type="text"/> Laboratory Vacuum: <input type="text"/> Utility Compressed Air: <input type="text"/>				
Plumbing Remarks: <input type="text"/>											Gas Remarks: <input type="text"/>				

**Appendix 1B Minimum Room Requirements**

Room Name:

Program Number(s):

1.	M2.23	7.		13.		19.		25.		31.		37.		43.
2.		8.		14.		20.		26.		32.		38.		44.
3.		9.		15.		21.		27.		33.		39.		45.
4.		10.		16.		22.		28.		34.		40.		46.
5.		11.		17.		23.		29.		35.		41.		47.
6.		12.		18.		24.		30.		36.		42.		48.

**ARCHITECTURAL REQUIREMENTS**

<b>WALL AND CEILING</b> Wall Material: <input type="text" value="ARGB 1.2m AFF, GB above"/> Finish: <input type="text" value="PT"/> Ceiling Material: <input type="text" value="ACT"/> Finish: <input type="text" value="PF"/>		<b>WALL PROTECTION</b> Type: <input type="text" value="FRP"/> <input checked="" type="checkbox"/> Corner Guards <input type="checkbox"/> Hand Rails <input type="checkbox"/> Bed Bumper / Locator Height: <input type="text" value="1600 mm"/> <input type="checkbox"/> Crash Rails <input checked="" type="checkbox"/> Chair Rail			<b>GLAZING</b> <input checked="" type="checkbox"/> Interior Glazing		<b>FLOORING TYPES</b> Material: <input type="text" value="SDVF"/> Base: <input type="text" value="FCB"/>		<b>ROOM ACCESSORIES</b> <input checked="" type="checkbox"/> Coat Hooks <input type="checkbox"/> Ceiling Lift <input checked="" type="checkbox"/> Magnetic Whiteboard <input type="checkbox"/> Mirror <input type="checkbox"/> Infant Change Table <input type="checkbox"/> Privacy Curtain		
--	--	--	--	--	--	--	---	--	--	--	--

- LEGEND:**
- WALL AND CEILING LEGEND:**
- AC Architectural Ceiling
  - ACT Acoustic Ceiling Tile
  - ACT-C Cleanroom
  - ARGB Abuse-Resistant Gypsum Board
  - GB Gypsum Board
  - IRGB Impact-Resistant Gypsum Board
  - KLCT Kitchen Lay-in Ceiling Tile
  - MMRGB Moisture and Mould-Resistant Gypsum Board
  - SACT Security Acoustic Ceiling Tile
- WALL FINISHES LEGEND:**
- EWC Epoxy Wall Coating
  - HPC High Performance Coating
  - PT Paint
- CEILING FINISHES LEGEND:**
- ECC Epoxy Ceiling Coating
  - HPC High Performance Coating
  - PF Prefinished
  - PT Paint
- WALL PROTECTION LEGEND:**
- ESRP Extruded Semi-Rigid PVCu Panel
  - FRL Fibre Reinforced Laminate
  - FRP Fibreglass Reinforced Plastic
  - PVV Protective Vinyl Wallcovering
  - RHIS Rigid High Impact Sheet
  - WSSP Wetwall Solid Surface Panel
  - WVV Wetroom Vinyl Wallcovering
- FLOOR FINISHES LEGEND:**
- CFS Concrete Floor Sealer
  - EFC Epoxy Floor Coating
  - PFC Polyurethane Floor Coating
  - RAF Rubber Athletic Flooring
  - RSF Rubber Sheet Flooring
  - SCF Seamless Cushioned Flooring
  - SDRF Static-Dissipative Rubber Sheet Flooring
  - SDVF Static-Dissipative Vinyl Sheet Flooring
  - VSF Vinyl Sheet Flooring
  - WSVF Wetroom Safety Vinyl Sheet Flooring
- FLOOR BASE LEGEND:**
- FCB Flash Cove Base
  - RB Rubber Base
  - SCF Seamless Cushioned Flooring

**DOORS**

Types:

Type	Qty	Size (mm)	Material	Finish	Side Lt.	Blinds	Protect.	Privacy Film	Function	Card Reader	Mag Lock	Auto Opener	Hold Open	Hinges	Accessory 1	Accessory 2	Accessory 3	Closer
C	1	1065 x 2135	Shielded	Prefinished			1 Low	<input checked="" type="checkbox"/>	Storeroom	<input checked="" type="checkbox"/>				Butt Hinge				Surface

Door Remarks:  Security Grille  Anti-barricade strategy

**MILLWORK AND SPECIALTY CASEWORK**

Storage Requirements:

**UPPER UNITS** (U1-U8) **SHELF** (S1)

**LOWER UNITS** (L1-L12) **RECEPTION/TRANSACTION COUNTER / CARE TEAM STATION DESK** (TC1, TC2) **UTILITY SINK AND COUNTER UNIT** (UC1)

**FULL-HEIGHT CABINETS** (C1-C5)

**Legend:**  
 Category 0 - None  
 Category 1 - Low (1% - 4%)  
 Category 2 - Med (5% - 9%)  
 Category 3 - High (10% or Greater)

Category	Min. Length (mm)	Motorized Adjustable Height	Standing Height	Specialty Casework
3	3000	<input checked="" type="checkbox"/>		

**FINISHES**

Full-height Cabinet:   
 Upper Millwork:   
 Countertop:   
 Lower Millwork:   
 Shelf:

Remarks:

**MECHANICAL REQUIREMENTS**

**PLUMBING** (Quantity)

Hygiene Sink:	Lavatory:	Kitchen Sink:	Seamless Kitchen Sink:	Utility / Process Sink:	Scrub Sink:	Floor Sink:
<input type="text"/>	<input type="text"/>	<input type="text"/>	<input type="text"/>	<input type="text"/>	<input type="text"/>	<input type="text"/>

Plumbing Remarks:

**Other Fixtures:**

- Shower
- Tub
- Ice Maker
- Water Closet
- Instantaneous Hot Water
- Eyewash Station
- Eyewash/Shower Station
- Emergency Shower
- Flush Rim Sink
- Floor Drain
- Water Bottle Refill Station

Other:

**MED / NON-MED GASES** (Quantity)

Oxygen:	Medical Air:	Medical Vacuum:	Nitrous Oxide:	CO2:	AGSS:	Nitrogen:	Laboratory Air:	Laboratory Vacuum:	Utility Compressed Air:
<input type="text"/>	<input type="text"/>	<input type="text"/>	<input type="text"/>	<input type="text"/>	<input type="text"/>	<input type="text"/>	<input type="text"/>	<input type="text"/>	<input type="text"/>

Gas Remarks:



**Appendix 1B Minimum Room Requirements**

Room Name:

Program Number(s):

1.	M1.33	7.		13.		19.		25.		31.		37.		43.
2.		8.		14.		20.		26.		32.		38.		44.
3.		9.		15.		21.		27.		33.		39.		45.
4.		10.		16.		22.		28.		34.		40.		46.
5.		11.		17.		23.		29.		35.		41.		47.
6.		12.		18.		24.		30.		36.		42.		48.

**ARCHITECTURAL REQUIREMENTS**

<b>WALL AND CEILING</b> Wall Material: <input type="text" value="ARGB 1.2m AFF, GB above"/> Finish: <input type="text" value="EWC"/> Ceiling Material: <input type="text" value="GB"/> Finish: <input type="text" value="ECC"/>		<b>WALL PROTECTION</b> Type: <input type="text" value="ESRP"/> <input type="checkbox"/> Corner Guards <input type="checkbox"/> Hand Rails <input type="checkbox"/> Bed Bumper / Locator Height: <input type="text" value="2185 mm"/> <input type="checkbox"/> Crash Rails <input type="checkbox"/> Chair Rail			<b>GLAZING</b> <input type="checkbox"/> Interior Glazing		<b>FLOORING TYPES</b> Material: <input type="text" value="EFC"/> <input type="text" value="FCB"/>		<b>ROOM ACCESSORIES</b> <input type="checkbox"/> Coat Hooks <input type="checkbox"/> Ceiling Lift <input type="checkbox"/> Magnetic Whiteboard <input type="checkbox"/> Mirror <input type="checkbox"/> Infant Change Table <input type="checkbox"/> Privacy Curtain		
---	--	---	--	--	---	--	--	--	--	--	--

- LEGEND:**
- WALL AND CEILING LEGEND:**
- AC Architectural Ceiling
  - ACT Acoustic Ceiling Tile
  - ACT-C Cleanroom
  - ARGB Abuse-Resistant Gypsum Board
  - GB Gypsum Board
  - IRGB Impact-Resistant Gypsum Board
  - KLCT Kitchen Lay-in Ceiling Tile
  - MMRGB Moisture and Mould-Resistant Gypsum Board
  - SACT Security Acoustic Ceiling Tile
- WALL FINISHES LEGEND:**
- EWC Epoxy Wall Coating
  - HPC High Performance Coating
  - PT Paint
- CEILING FINISHES LEGEND:**
- ECC Epoxy Ceiling Coating
  - HPC High Performance Coating
  - PF Prefinished
  - PT Paint
- WALL PROTECTION LEGEND:**
- ESRP Extruded Semi-Rigid PVCu Panel
  - FRL Fibre Reinforced Laminate
  - FRP Fibreglass Reinforced Plastic
  - PVV Protective Vinyl Wallcovering
  - RHIS Rigid High Impact Sheet
  - WSSP Wetwall Solid Surface Panel
  - WVV Wetroom Vinyl Wallcovering
- FLOOR FINISHES LEGEND:**
- CFS Concrete Floor Sealer
  - EFC Epoxy Floor Coating
  - PFC Polyurethane Floor Coating
  - RAF Rubber Athletic Flooring
  - RSF Rubber Sheet Flooring
  - SCF Seamless Cushioned Flooring
  - SDRF Static-Dissipative Rubber Sheet Flooring
  - SDVF Static-Dissipative Vinyl Sheet Flooring
  - VSF Vinyl Sheet Flooring
  - WSVF Wetroom Safety Vinyl Sheet Flooring
- FLOOR BASE LEGEND:**
- FCB Flash Cove Base
  - RB Rubber Base
  - SCF Seamless Cushioned Flooring

**DOORS**

Types:

Type	Qty	Size (mm)	Material	Finish	Side Lt.	Blinds	Protect.	Privacy Film	Function	Card Reader	Mag Lock	Auto Opener	Hold Open	Hinges	Accessory 1	Accessory 2	Accessory 3	Closer
A	1	1065 x 2135	Neutron	Prefinished	<input type="checkbox"/>	<input type="checkbox"/>		<input type="checkbox"/>		<input type="checkbox"/>	<input type="checkbox"/>	<input type="checkbox"/>	<input type="checkbox"/>					

Door Remarks:  Security Grille  Anti-barricade strategy

Neutron Door and Frame - Refer to SOR



**MECHANICAL REQUIREMENTS**

<b>PLUMBING</b> (Quantity) Hygiene Sink: <input type="text"/> Lavatory: <input type="text"/> Kitchen Sink: <input type="text"/> Kitchen Sink: <input type="text"/> Utility / Process Sink: <input type="text"/> Scrub Sink: <input type="text"/> Floor Sink: <input type="text"/>		Other Fixtures: <input type="checkbox"/> Shower <input type="checkbox"/> Tub <input type="checkbox"/> Ice Maker <input type="checkbox"/> Water Closet <input type="checkbox"/> Instantaneous Hot Water		<input type="checkbox"/> Eyewash Station <input type="checkbox"/> Eyewash/Shower Station <input type="checkbox"/> Emergency Shower <input type="checkbox"/> Flush Rim Sink <input checked="" type="checkbox"/> Floor Drain <input type="checkbox"/> Water Bottle Refill Station		<b>MED / NON-MED GASES</b> (Quantity) Oxygen: <input type="text"/> Medical Air: <input type="text"/> Medical Vacuum: <input type="text"/> Nitrous Oxide: <input type="text"/> CO2: <input type="text"/> AGSS: <input type="text"/> Nitrogen: <input type="text"/> Laboratory Air: <input type="text"/> Laboratory Vacuum: <input type="text"/> Utility Compressed Air: <input type="text"/>					
Plumbing Remarks: Provide (2) floor drains. Cyclotron & beam lines cooling loop to use DI water. De-ionized water package & controls to be supplied with cyclotron.		Other: <input type="text"/>		Gas Remarks: Provide the following gasses to - the cyclotron machine - N2, H2, He, CA. - the beam line - CA, N2, N2 + 0.5% O2, N2 + 10% H2, He, Ar, Ar + 10% F2.							

**Appendix 1B Minimum Room Requirements**

Room Name:

Program Number(s):

1. M1.31	7.	13.	19.	25.	31.	37.	43.
2.	8.	14.	20.	26.	32.	38.	44.
3.	9.	15.	21.	27.	33.	39.	45.
4.	10.	16.	22.	28.	34.	40.	46.
5.	11.	17.	23.	29.	35.	41.	47.
6.	12.	18.	24.	30.	36.	42.	48.

**ARCHITECTURAL REQUIREMENTS**

<b>WALL AND CEILING</b> Wall Material: <input type="text" value="ARGB 1.2m AFF, GB above"/> Finish: <input type="text" value="EWC"/> Ceiling Material: <input type="text" value="GB"/> Finish: <input type="text" value="ECC"/>		<b>WALL PROTECTION</b> Type: <input type="text" value="ESRP"/> <input checked="" type="checkbox"/> Corner Guards <input type="checkbox"/> Hand Rails <input type="checkbox"/> Bed Bumper / Locator Height: <input type="text" value="2185 mm"/> <input type="checkbox"/> Crash Rails <input type="checkbox"/> Chair Rail		<b>GLAZING</b> <input type="checkbox"/> Interior Glazing		<b>FLOORING TYPES</b> Material: <input type="text" value="EFC"/> Base: <input type="text" value="FCB"/>		<b>ROOM ACCESSORIES</b> <input type="checkbox"/> Coat Hooks <input type="checkbox"/> Ceiling Lift <input type="checkbox"/> Magnetic Whiteboard <input type="checkbox"/> Mirror <input type="checkbox"/> Infant Change Table <input type="checkbox"/> Privacy Curtain	
---	--	--	--	---	--	--	--	--	--

- LEGEND:**
- WALL AND CEILING LEGEND:**
- AC Architectural Ceiling
  - ACT Acoustic Ceiling Tile
  - ACT-C Cleanroom
  - ARGB Abuse-Resistant Gypsum Board
  - GB Gypsum Board
  - IRGB Impact-Resistant Gypsum Board
  - KLCT Kitchen Lay-in Ceiling Tile
  - MMRGB Moisture and Mould-Resistant Gypsum Board
  - SACT Security Acoustic Ceiling Tile
- WALL FINISHES LEGEND:**
- EWC Epoxy Wall Coating
  - HPC High Performance Coating
  - PT Paint
- CEILING FINISHES LEGEND:**
- ECC Epoxy Ceiling Coating
  - HPC High Performance Coating
  - PF Prefinished
  - PT Paint
- WALL PROTECTION LEGEND:**
- ESRP Extruded Semi-Rigid PVCu Panel
  - FRL Fibre Reinforced Laminate
  - FRP Fibreglass Reinforced Plastic
  - PVV Protective Vinyl Wallcovering
  - RHIS Rigid High Impact Sheet
  - WSSP Wetwall Solid Surface Panel
  - WVV Wetroom Vinyl Wallcovering
- FLOOR FINISHES LEGEND:**
- CFS Concrete Floor Sealer
  - EFC Epoxy Floor Coating
  - PFC Polyurethane Floor Coating
  - RAF Rubber Athletic Flooring
  - RSF Rubber Sheet Flooring
  - SCF Seamless Cushioned Flooring
  - SDRF Static-Dissipative Rubber Sheet Flooring
  - SDVF Static-Dissipative Vinyl Sheet Flooring
  - VSF Vinyl Sheet Flooring
  - WSVF Wetroom Safety Vinyl Sheet Flooring
- FLOOR BASE LEGEND:**
- FCB Flash Cove Base
  - RB Rubber Base
  - SCF Seamless Cushioned Flooring

**DOORS**

Types:

Note: for Type F doors, the door panels will be approximately 465/1065 unless otherwise required by the Authority

Door Remarks:  Security Grille  Anti-barricade strategy

Type	Qty	Size (mm)	Material	Finish	Side Lt.	Blinds	Protect.	Privacy Film	Function	Card Reader	Mag Lock	Auto Opener	Hold Open	Hinges	Accessory 1	Accessory 2	Accessory 3	Closer
F2	1	1530 x 2135	Hollow Metal	Paint	<input type="checkbox"/>	<input type="checkbox"/>		<input type="checkbox"/>	Storeroom	<input checked="" type="checkbox"/>	<input type="checkbox"/>	<input type="checkbox"/>	<input checked="" type="checkbox"/>	Butt Hinge	Astragal	Flush Bolt		Surface

**MILLWORK AND SPECIALTY CASEWORK**

Storage Requirements:

**UPPER UNITS** (U1-U8)

**LOWER UNITS** (L1-L12)

**RECEPTION/TRANSACTION COUNTER / CARE TEAM STATION DESK** (TC1, TC2)

**UTILITY SINK AND COUNTER UNIT** (UC1)

**FINISHES**

Full-height Cabinet:

Upper Millwork:

Countertop:

Lower Millwork:

Shelf:

Remarks:

Category	Min. Length (mm)	Motorized Adjustable Height	Standing Height	Specialty Casework
1	900	<input type="checkbox"/>	<input type="checkbox"/>	<input type="checkbox"/>

**MECHANICAL REQUIREMENTS**

**PLUMBING**

Hand Hygiene Sink:	Lavatory:	Kitchen Sink:	Seamless Kitchen Sink:	Utility / Process Sink:	Scrub Sink:	Floor Sink:
				1		

Plumbing Remarks:

**Other Fixtures:**

- Shower
- Tub
- Ice Maker
- Water Closet
- Instantaneous Hot Water
- Eyewash Station
- Eyewash/Shower Station
- Emergency Shower
- Flush Rim Sink
- Floor Drain
- Water Bottle Refill Station

Other:

**MED / NON-MED GASES**

Oxygen:	Medical Air:	Medical Vacuum:	Nitrous Oxide:	CO2:	AGSS:	Nitrogen:	Laboratory Air:	Laboratory Vacuum:	Utility Compressed Air:
									2

Gas Remarks:

**Appendix 1B Minimum Room Requirements**

Room Name:

Program Number(s):

1.	M2.25	7.		13.		19.		25.		31.		37.		43.
2.		8.		14.		20.		26.		32.		38.		44.
3.		9.		15.		21.		27.		33.		39.		45.
4.		10.		16.		22.		28.		34.		40.		46.
5.		11.		17.		23.		29.		35.		41.		47.
6.		12.		18.		24.		30.		36.		42.		48.

**ARCHITECTURAL REQUIREMENTS**

<b>WALL AND CEILING</b> Wall Material: <input type="text" value="ARGB 1.2m AFF, GB above"/> Finish: <input type="text" value="PT"/> Ceiling Material: <input type="text" value="ACT"/> Finish: <input type="text" value="PF"/>		<b>WALL PROTECTION</b> Type: <input type="text" value="PVW"/> <input checked="" type="checkbox"/> Corner Guards <input type="checkbox"/> Hand Rails <input type="checkbox"/> Bed Bumper / Locator Height: <input type="text" value="1600 mm"/> <input type="checkbox"/> Crash Rails <input type="checkbox"/> Chair Rail		<b>GLAZING</b> <input type="checkbox"/> Interior Glazing		<b>FLOORING TYPES</b> Material: <input type="text" value="RSF"/> Base: <input type="text" value="FCB"/>		<b>ROOM ACCESSORIES</b> <input checked="" type="checkbox"/> Coat Hooks <input checked="" type="checkbox"/> Ceiling Lift <input type="checkbox"/> Magnetic Whiteboard <input type="checkbox"/> Mirror <input type="checkbox"/> Infant Change Table <input checked="" type="checkbox"/> Privacy Curtain	
--	--	---	--	---	--	--	--	---	--

- LEGEND:**
- WALL AND CEILING LEGEND:**
- AC Architectural Ceiling
  - ACT Acoustic Ceiling Tile
  - ACT-C Cleanroom
  - ARGB Abuse-Resistant Gypsum Board
  - GB Gypsum Board
  - IRGB Impact-Resistant Gypsum Board
  - KLCT Kitchen Lay-in Ceiling Tile
  - MMRGB Moisture and Mould-Resistant Gypsum Board
  - SACT Security Acoustic Ceiling Tile
- WALL FINISHES LEGEND:**
- EWC Epoxy Wall Coating
  - HPC High Performance Coating
  - PT Paint
- CEILING FINISHES LEGEND:**
- ECC Epoxy Ceiling Coating
  - HPC High Performance Coating
  - PF Prefinished
  - PT Paint
- WALL PROTECTION LEGEND:**
- ESRP Extruded Semi-Rigid PVCu Panel
  - FRL Fibre Reinforced Laminat
  - FRP Fibreglass Reinforced Plastic
  - PVW Protective Vinyl Wallcovering
  - RHIS Rigid High Impact Sheet
  - WSSP Wetwall Solid Surface Panel
  - WVV Wetroom Vinyl Wallcovering
- FLOOR FINISHES LEGEND:**
- CFS Concrete Floor Sealer
  - EFC Epoxy Floor Coating
  - PFC Polyurethane Floor Coating
  - RAF Rubber Athletic Flooring
  - RSF Rubber Sheet Flooring
  - SCF Seamless Cushioned Flooring
  - SDRF Static-Dissipative Rubber Sheet Flooring
  - SDVF Static-Dissipative Vinyl Sheet Flooring
  - VSF Vinyl Sheet Flooring
  - WSVF Wetroom Safety Vinyl Sheet Flooring
- FLOOR BASE LEGEND:**
- FCB Flash Cove Base
  - RB Rubber Base
  - SCF Seamless Cushioned Flooring

**DOORS**

Types:

Note: for Type F doors, the door panels will be approximately 465/1065 unless otherwise required by the Authority

Door Remarks:  Security Grille  Anti-barricade strategy

Type	Qty	Size (mm)	Material	Finish	Side Lt	Blinds	Protect	Privacy Film	Function	Card Reader	Mag Lock	Auto Opener	Hold Open	Hinges	Accessory 1	Accessory 2	Accessory 3	Closer
F2	1	1530 x 2135	Solid Core	FRL	<input type="checkbox"/>	<input type="checkbox"/>		<input type="checkbox"/>	Passage	<input type="checkbox"/>	<input type="checkbox"/>	<input type="checkbox"/>	<input type="checkbox"/>	Butt Hinge	Astragal	Flush Bolt		Concealed

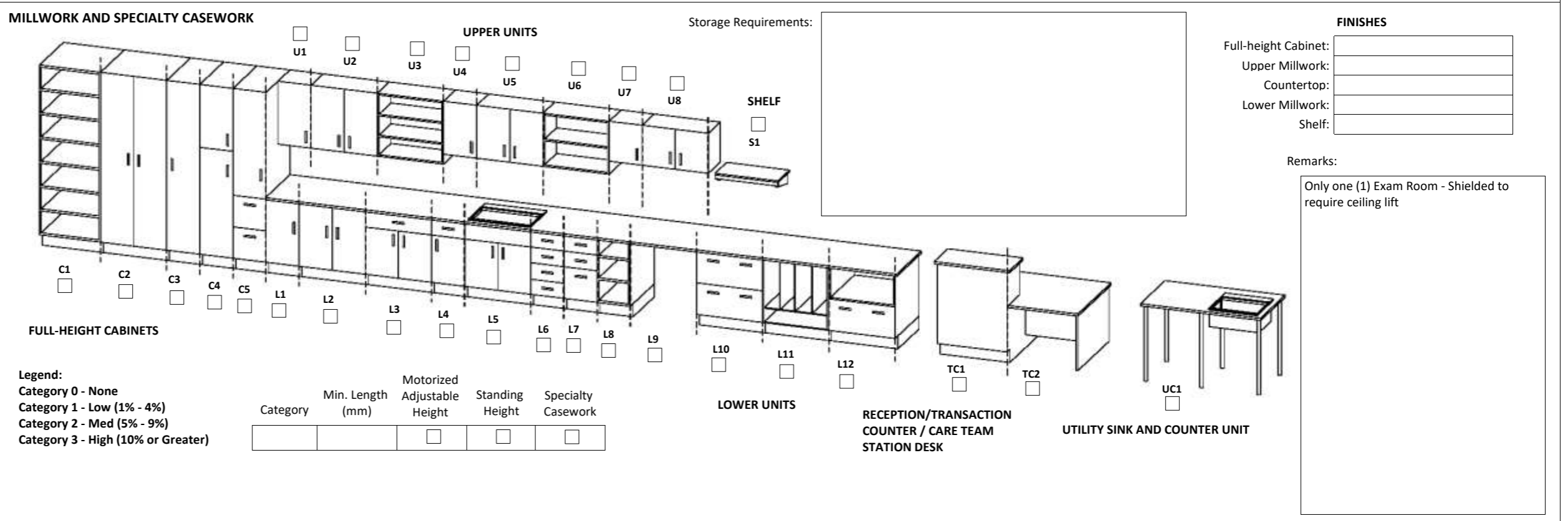

**MECHANICAL REQUIREMENTS**

<b>PLUMBING</b> (Quantity) Hand Hygiene Sink: <input type="text"/> Lavatory: <input type="text"/> Kitchen Sink: <input type="text"/> Seamless Kitchen Sink: <input type="text"/> Utility / Process Sink: <input type="text"/> Scrub Sink: <input type="text"/> Floor Sink: <input type="text"/>		Other Fixtures: <input type="checkbox"/> Shower <input type="checkbox"/> Eyewash Station <input type="checkbox"/> Tub <input type="checkbox"/> Eyewash/Shower Station <input type="checkbox"/> Ice Maker <input type="checkbox"/> Emergency Shower <input type="checkbox"/> Water Closet <input type="checkbox"/> Flush Rim Sink <input type="checkbox"/> Instantaneous Hot Water <input type="checkbox"/> Floor Drain <input type="checkbox"/> Water Bottle Refill Station Other: <input type="text"/>		<b>MED / NON-MED GASES</b> (Quantity) Oxygen: <input type="text" value="1"/> Medical Air: <input type="text" value="1"/> Medical Vacuum: <input type="text" value="1"/> Nitrous Oxide: <input type="text"/> CO2: <input type="text"/> AGSS: <input type="text"/> Nitrogen: <input type="text"/> Laboratory Air: <input type="text"/> Laboratory Vacuum: <input type="text"/> Utility Compressed Air: <input type="text"/>	
Plumbing Remarks: <input type="text"/>		Gas Remarks: <input type="text" value="Medical gases to Patient's right."/>			



# Appendix 1B Minimum Room Requirements

Room Name:

Program Number(s):

1. M1.38	7.	13.	19.	25.	31.	37.	43.
2.	8.	14.	20.	26.	32.	38.	44.
3.	9.	15.	21.	27.	33.	39.	45.
4.	10.	16.	22.	28.	34.	40.	46.
5.	11.	17.	23.	29.	35.	41.	47.
6.	12.	18.	24.	30.	36.	42.	48.

## ARCHITECTURAL REQUIREMENTS

<b>WALL AND CEILING</b> Wall Material: <input type="text" value="ARGB 1.2m AFF, GB above"/> Finish: <input type="text" value="EWC"/> Ceiling Material: <input type="text" value="GB"/> Finish: <input type="text" value="ECC"/>	<b>WALL PROTECTION</b> Type: <input type="text" value="ESRP"/> <input checked="" type="checkbox"/> Corner Guards <input type="checkbox"/> Hand Rails <input type="checkbox"/> Bed Bumper / Locator Height: <input type="text" value="2185 mm"/> <input type="checkbox"/> Crash Rails <input type="checkbox"/> Chair Rail	<b>GLAZING</b> <input type="checkbox"/> Interior Glazing	<b>FLOORING TYPES</b> Material: <input type="text" value="RSF"/> Base: <input type="text" value="FCB"/>	<b>ROOM ACCESSORIES</b> <input checked="" type="checkbox"/> Coat Hooks <input type="checkbox"/> Ceiling Lift <input type="checkbox"/> Magnetic Whiteboard <input checked="" type="checkbox"/> Mirror <input type="checkbox"/> Infant Change Table <input type="checkbox"/> Privacy Curtain
---	--	---	--	--

- LEGEND:**
- WALL AND CEILING LEGEND:**
- AC Architectural Ceiling
  - ACT Acoustic Ceiling Tile
  - ACT-C Cleanroom
  - ARGB Abuse-Resistant Gypsum Board
  - GB Gypsum Board
  - IRGB Impact-Resistant Gypsum Board
  - KLCT Kitchen Lay-in Ceiling Tile
  - MMRGB Moisture and Mould-Resistant Gypsum Board
  - SACT Security Acoustic Ceiling Tile
- WALL FINISHES LEGEND:**
- EWC Epoxy Wall Coating
  - HPC High Performance Coating
  - PT Paint
- CEILING FINISHES LEGEND:**
- ECC Epoxy Ceiling Coating
  - HPC High Performance Coating
  - PF Prefinished
  - PT Paint
- WALL PROTECTION LEGEND:**
- ESRP Extruded Semi-Rigid PVCu Panel
  - FRL Fibre Reinforced Laminate
  - FRP Fibreglass Reinforced Plastic
  - PVV Protective Vinyl Wallcovering
  - RHIS Rigid High Impact Sheet
  - WSSP Wetwall Solid Surface Panel
  - WVV Wetroom Vinyl Wallcovering
- FLOOR FINISHES LEGEND:**
- CFS Concrete Floor Sealer
  - EFC Epoxy Floor Coating
  - PFC Polyurethane Floor Coating
  - RAF Rubber Athletic Flooring
  - RSF Rubber Sheet Flooring
  - SCF Seamless Cushioned Flooring
  - SDRF Static-Dissipative Rubber Sheet Flooring
  - SDVF Static-Dissipative Vinyl Sheet Flooring
  - VSF Vinyl Sheet Flooring
  - WSVF Wetroom Safety Vinyl Sheet Flooring
- FLOOR BASE LEGEND:**
- FCB Flash Cove Base
  - RB Rubber Base
  - SCF Seamless Cushioned Flooring

**DOORS**

Types:

Type:Qty:	Size (mm):	Material:	Finish:	Side Lt:	Blinds:	Protect.:	Privacy Film:	Function:	Card Reader:	Mag Lock:	Auto Opener:	Hold Open:	Hinges:	Accessory 1:	Accessory 2:	Accessory 3:	Closer:

Door Remarks:  Security Grille  Anti-barricade strategy

**MILLWORK AND SPECIALTY CASEWORK**

Storage Requirements:

**UPPER UNITS** (U1-U8) **SHELF** (S1)

**FULL-HEIGHT CABINETS** (C1-C5) **LOWER UNITS** (L1-L12) **RECEPTION/TRANSACTION COUNTER / CARE TEAM STATION DESK** (TC1-TC2) **UTILITY SINK AND COUNTER UNIT** (UC1)

Category	Min. Length (mm)	Motorized Adjustable Height	Standing Height	Specialty Casework
1	600	<input type="checkbox"/>	<input type="checkbox"/>	<input type="checkbox"/>

**FINISHES**

Full-height Cabinet:   
 Upper Millwork:   
 Countertop:   
 Lower Millwork:   
 Shelf:

Remarks: Provide stainless steel shelves and stainless steel bench. Provide ceiling hatches with gaskets.

## MECHANICAL REQUIREMENTS

<b>PLUMBING</b> (Quantity) Hand Hygiene Sink: <input type="text"/> Lavatory: <input type="text"/> Kitchen Sink: <input type="text"/> Seamless Kitchen Sink: <input type="text"/> Utility / Process Sink: <input type="text"/> Scrub Sink: <input type="text"/> Floor Sink: <input type="text"/> Plumbing Remarks: <input type="text"/>	Other Fixtures: <input type="checkbox"/> Shower <input type="checkbox"/> Eyewash Station <input type="checkbox"/> Tub <input type="checkbox"/> Eyewash/Shower Station <input type="checkbox"/> Ice Maker <input type="checkbox"/> Emergency Shower <input type="checkbox"/> Water Closet <input type="checkbox"/> Flush Rim Sink <input type="checkbox"/> Instantaneous Hot Water <input type="checkbox"/> Floor Drain <input type="checkbox"/> Water Bottle Refill Station Other: <input type="text"/>	<b>MED / NON-MED GASES</b> (Quantity) Oxygen: <input type="text"/> Medical Air: <input type="text"/> Medical Vacuum: <input type="text"/> Nitrous Oxide: <input type="text"/> CO2: <input type="text"/> AGSS: <input type="text"/> Nitrogen: <input type="text"/> Laboratory Air: <input type="text"/> Laboratory Vacuum: <input type="text"/> Utility Compressed Air: <input type="text"/> Gas Remarks: <input type="text"/>
---	--	---

**Appendix 1B Minimum Room Requirements**

Room Name:

Program Number(s):

1. M2.21	7.	13.	19.	25.	31.	37.	43.
2.	8.	14.	20.	26.	32.	38.	44.
3.	9.	15.	21.	27.	33.	39.	45.
4.	10.	16.	22.	28.	34.	40.	46.
5.	11.	17.	23.	29.	35.	41.	47.
6.	12.	18.	24.	30.	36.	42.	48.

**ARCHITECTURAL REQUIREMENTS**

<b>WALL AND CEILING</b> Wall Material: <input type="text" value="ARGB 1.2m AFF, GB above"/> Finish: <input type="text" value="PT"/> Ceiling Material: <input type="text" value="ACT"/> Finish: <input type="text" value="PF"/>	<b>WALL PROTECTION</b> Type: <input type="text" value="PVW"/> <input checked="" type="checkbox"/> Corner Guards <input type="checkbox"/> Hand Rails <input type="checkbox"/> Bed Bumper / Locator Height: <input type="text" value="1350 mm"/> <input type="checkbox"/> Crash Rails <input type="checkbox"/> Chair Rail	<b>GLAZING</b> <input type="checkbox"/> Interior Glazing	<b>FLOORING TYPES</b> Material: <input type="text" value="SDVF"/> Base: <input type="text" value="FCB"/>	<b>ROOM ACCESSORIES</b> <input checked="" type="checkbox"/> Coat Hooks <input checked="" type="checkbox"/> Ceiling Lift <input type="checkbox"/> Magnetic Whiteboard <input type="checkbox"/> Mirror <input type="checkbox"/> Infant Change Table <input type="checkbox"/> Privacy Curtain
--	---	---	---	--

- LEGEND:**
- WALL AND CEILING LEGEND:**
- AC Architectural Ceiling
  - ACT Acoustic Ceiling Tile
  - ACT-C Cleanroom
  - ARGB Abuse-Resistant Gypsum Board
  - GB Gypsum Board
  - IRGB Impact-Resistant Gypsum Board
  - KLCT Kitchen Lay-in Ceiling Tile
  - MMRGB Moisture and Mould-Resistant Gypsum Board
  - SACT Security Acoustic Ceiling Tile
- WALL FINISHES LEGEND:**
- EWC Epoxy Wall Coating
  - HPC High Performance Coating
  - PT Paint
- CEILING FINISHES LEGEND:**
- ECC Epoxy Ceiling Coating
  - HPC High Performance Coating
  - PF Prefinished
  - PT Paint
- WALL PROTECTION LEGEND:**
- ESRP Extruded Semi-Rigid PVCu Panel
  - FRL Fibre Reinforced Laminate
  - FRP Fibreglass Reinforced Plastic
  - PVW Protective Vinyl Wallcovering
  - RHIS Rigid High Impact Sheet
  - WSSP Wetwall Solid Surface Panel
  - WVV Wetroom Vinyl Wallcovering
- FLOOR FINISHES LEGEND:**
- CFS Concrete Floor Sealer
  - EFC Epoxy Floor Coating
  - PFC Polyurethane Floor Coating
  - RAF Rubber Athletic Flooring
  - RSF Rubber Sheet Flooring
  - SCF Seamless Cushioned Flooring
  - SDRF Static-Dissipative Rubber Sheet Flooring
  - SDVF Static-Dissipative Vinyl Sheet Flooring
  - VSF Vinyl Sheet Flooring
  - WSVF Wetroom Safety Vinyl Sheet Flooring
- FLOOR BASE LEGEND:**
- FCB Flash Cove Base
  - RB Rubber Base
  - SCF Seamless Cushioned Flooring

**DOORS**

Types:

Note: for Type F doors, the door panels will be approximately 465/1065 unless otherwise required by the Authority

Type	Qty	Size (mm)	Material	Finish	Side Lt.	Blinds	Protect.	Privacy Film	Function	Card Reader	Mag Lock	Auto Opener	Hold Open	Hinges	Accessory 1	Accessory 2	Accessory 3	Closer
F2	1	1530 x 2135	Solid Core	FRL	<input type="checkbox"/>	<input type="checkbox"/>	2 High	<input checked="" type="checkbox"/>	Storeroom	<input checked="" type="checkbox"/>	<input checked="" type="checkbox"/>	<input type="checkbox"/>	<input checked="" type="checkbox"/>	Butt Hinge	Astragal	Flush Bolt		Concealed

**DOOR REMARKS:**

Security Grille  
 Anti-barricade strategy

**MILLWORK AND SPECIALTY CASEWORK**

Storage Requirements:

**UPPER UNITS:** U1, U2, U3, U4, U5, U6, U7, U8

**LOWER UNITS:** L1, L2, L3, L4, L5, L6, L7, L8, L9

**RECEPTION/TRANSACTION COUNTER / CARE TEAM STATION DESK:** TC1, TC2

**UTILITY SINK AND COUNTER UNIT:** UC1

**SHELF:** S1

**FINISHES**

Full-height Cabinet:	Plastic Laminate
Upper Millwork:	Plastic Laminate
Countertop:	Solid Surfacing
Lower Millwork:	Plastic Laminate
Shelf:	

**REMARKS:**

C4 to have no kickplate  
Provide millwork box in the ceiling to house laser

**Legend:**

Category	Min. Length (mm)	Motorized Adjustable Height	Standing Height	Specialty Casework
1	3300	<input type="checkbox"/>	<input type="checkbox"/>	<input type="checkbox"/>

**MECHANICAL REQUIREMENTS**

**PLUMBING**

Hand Hygiene Sink: <input type="text" value="1"/>	Lavatory: <input type="text"/>	Kitchen Sink: <input type="text"/>	Seamless Kitchen Sink: <input type="text"/>	Utility / Process Sink: <input type="text" value="1"/>	Scrub Sink: <input type="text"/>	Floor Sink: <input type="text"/>
---	--------------------------------	------------------------------------	---	--	----------------------------------	----------------------------------

Plumbing Remarks:

**Other Fixtures:**

- Shower
- Tub
- Ice Maker
- Water Closet
- Instantaneous Hot Water
- Eyewash Station
- Eyewash/Shower Station
- Emergency Shower
- Flush Rim Sink
- Floor Drain
- Water Bottle Refill Station

Other:

**MED / NON-MED GASES**

Oxygen:	Medical Air:	Medical Vacuum:	Nitrous Oxide:	CO2:	AGSS:	Nitrogen:	Laboratory Air:	Laboratory Vacuum:	Utility Compressed Air:
<input type="text" value="1"/>	<input type="text" value="1"/>	<input type="text" value="1"/>	<input type="text" value="0"/>	<input type="text" value="1"/>	<input type="text" value="1"/>	<input type="text"/>	<input type="text"/>	<input type="text"/>	<input type="text"/>

Gas Remarks:

**Appendix 1B Minimum Room Requirements**

Room Name:

Program Number(s):

1. M2.22	7.	13.	19.	25.	31.	37.	43.
2.	8.	14.	20.	26.	32.	38.	44.
3.	9.	15.	21.	27.	33.	39.	45.
4.	10.	16.	22.	28.	34.	40.	46.
5.	11.	17.	23.	29.	35.	41.	47.
6.	12.	18.	24.	30.	36.	42.	48.

**ARCHITECTURAL REQUIREMENTS**

<b>WALL AND CEILING</b> Wall Material: <input type="text" value="ARGB 1.2m AFF, GB above"/> Finish: <input type="text" value="PT"/> Ceiling Material: <input type="text" value="ACT"/> Finish: <input type="text" value="PF"/>	<b>WALL PROTECTION</b> Type: <input type="text" value="PVW"/> <input checked="" type="checkbox"/> Corner Guards <input type="checkbox"/> Hand Rails <input type="checkbox"/> Bed Bumper / Locator Height: <input type="text" value="1350 mm"/> <input type="checkbox"/> Crash Rails <input type="checkbox"/> Chair Rail	<b>GLAZING</b> <input type="checkbox"/> Interior Glazing	<b>FLOORING TYPES</b> Material: <input type="text" value="SDVF"/> Base: <input type="text" value="FCB"/>	<b>ROOM ACCESSORIES</b> <input checked="" type="checkbox"/> Coat Hooks <input type="checkbox"/> Ceiling Lift <input type="checkbox"/> Magnetic Whiteboard <input type="checkbox"/> Mirror <input type="checkbox"/> Infant Change Table <input type="checkbox"/> Privacy Curtain
--	---	---	---	---

- LEGEND:**
- WALL AND CEILING LEGEND:**
- AC Architectural Ceiling
  - ACT Acoustic Ceiling Tile
  - ACT-C Cleanroom
  - ARGB Abuse-Resistant Gypsum Board
  - GB Gypsum Board
  - IRGB Impact-Resistant Gypsum Board
  - KLCT Kitchen Lay-in Ceiling Tile
  - MMRGB Moisture and Mould-Resistant Gypsum Board
  - SACT Security Acoustic Ceiling Tile
- WALL FINISHES LEGEND:**
- EWC Epoxy Wall Coating
  - HPC High Performance Coating
  - PT Paint
- CEILING FINISHES LEGEND:**
- ECC Epoxy Ceiling Coating
  - HPC High Performance Coating
  - PF Prefinished
  - PT Paint
- WALL PROTECTION LEGEND:**
- ESRP Extruded Semi-Rigid PVCu Panel
  - FRL Fibre Reinforced Laminate
  - FRP Fibreglass Reinforced Plastic
  - PVW Protective Vinyl Wallcovering
  - RHIS Rigid High Impact Sheet
  - WSSP Wetwall Solid Surface Panel
  - WVV Wetroom Vinyl Wallcovering
- FLOOR FINISHES LEGEND:**
- CFS Concrete Floor Sealer
  - EFC Epoxy Floor Coating
  - PFC Polyurethane Floor Coating
  - RAF Rubber Athletic Flooring
  - RSF Rubber Sheet Flooring
  - SCF Seamless Cushioned Flooring
  - SDRF Static-Dissipative Rubber Sheet Flooring
  - SDVF Static-Dissipative Vinyl Sheet Flooring
  - VSF Vinyl Sheet Flooring
  - WSVF Wetroom Safety Vinyl Sheet Flooring
- FLOOR BASE LEGEND:**
- FCB Flash Cove Base
  - RB Rubber Base
  - SCF Seamless Cushioned Flooring

**DOORS**

Types:

Note: for Type F doors, the door panels will be approximately 465/1065 unless otherwise required by the Authority

Type	Qty	Size (mm)	Material	Finish	Side Lt.	Blinds	Protect.	Privacy Film	Function	Card Reader	Mag Lock	Auto Opener	Hold Open	Hinges	Accessory 1	Accessory 2	Accessory 3	Closer
F2	1	1530 x 2135	Shielded	Prefinished	<input type="checkbox"/>	<input type="checkbox"/>	2 High	<input checked="" type="checkbox"/>	Storeroom	<input checked="" type="checkbox"/>	<input checked="" type="checkbox"/>	<input type="checkbox"/>	<input checked="" type="checkbox"/>	Butt Hinge	Astragal	Flush Bolt		Concealed

**DOOR REMARKS:**

Security Grille  
 Anti-barricade strategy

**MILLWORK AND SPECIALTY CASEWORK**

Storage Requirements:

**UPPER UNITS:** U1, U2, U3, U4, U5, U6, U7, U8

**LOWER UNITS:** L1, L2, L3, L4, L5, L6, L7, L8, L9

**RECEPTION/TRANSACTION COUNTER / CARE TEAM STATION DESK:** TC1, TC2

**UTILITY SINK AND COUNTER UNIT:** UC1

**SHELF:** S1

**FINISHES**

Full-height Cabinet:	Plastic Laminate
Upper Millwork:	Plastic Laminate
Countertop:	Solid Surfacing
Lower Millwork:	Plastic Laminate
Shelf:	

**REMARKS:**

Lower cabinets to have no kickplate  
Provide millwork box in the ceiling to house laser

**Legend:**

Category	Min. Length (mm)	Motorized Adjustable Height	Standing Height	Specialty Casework
1	3300	<input type="checkbox"/>	<input type="checkbox"/>	<input type="checkbox"/>

**MECHANICAL REQUIREMENTS**

<b>PLUMBING</b> (Quantity) Hand Hygiene Sink: <input type="text" value="1"/> Lavatory: <input type="text"/> Kitchen Sink: <input type="text"/> Seamless Kitchen Sink: <input type="text"/> Utility / Process Sink: <input type="text" value="1"/> Scrub Sink: <input type="text"/> Floor Sink: <input type="text"/> Plumbing Remarks: <input type="text"/>	Other Fixtures: <input type="checkbox"/> Shower <input type="checkbox"/> Tub <input type="checkbox"/> Ice Maker <input type="checkbox"/> Water Closet <input type="checkbox"/> Instantaneous Hot Water <input type="checkbox"/> Eyewash Station <input type="checkbox"/> Eyewash/Shower Station <input type="checkbox"/> Emergency Shower <input type="checkbox"/> Flush Rim Sink <input type="checkbox"/> Floor Drain <input type="checkbox"/> Water Bottle Refill Station Other: <input type="text"/>	<b>MED / NON-MED GASES</b> (Quantity) Oxygen: <input type="text" value="1"/> Medical Air: <input type="text" value="1"/> Medical Vacuum: <input type="text" value="1"/> Nitrous Oxide: <input type="text"/> CO2: <input type="text"/> AGSS: <input type="text"/> Nitrogen: <input type="text"/> Laboratory Air: <input type="text"/> Laboratory Vacuum: <input type="text"/> Utility Compressed Air: <input type="text"/> Gas Remarks: <input type="text"/>
---	---	---



**Appendix 1B Minimum Room Requirements**

Room Name:

Program Number(s):

1. M1.15	7.	13.	19.	25.	31.	37.	43.
2.	8.	14.	20.	26.	32.	38.	44.
3.	9.	15.	21.	27.	33.	39.	45.
4.	10.	16.	22.	28.	34.	40.	46.
5.	11.	17.	23.	29.	35.	41.	47.
6.	12.	18.	24.	30.	36.	42.	48.

**ARCHITECTURAL REQUIREMENTS**

<b>WALL AND CEILING</b> Wall Material: <input type="text" value="ARGB 1.2m AFF, GB above"/> Finish: <input type="text" value="HPC"/> Ceiling Material: <input type="text" value="ACT-C"/> Finish: <input type="text" value="PF"/>	<b>WALL PROTECTION</b> Type: <input type="text" value="FRP"/> <input checked="" type="checkbox"/> Corner Guards <input type="checkbox"/> Hand Rails <input type="checkbox"/> Bed Bumper / Locator Height: <input type="text" value="1600 mm"/> <input type="checkbox"/> Crash Rails <input type="checkbox"/> Chair Rail	<b>GLAZING</b> <input type="checkbox"/> Interior Glazing	<b>FLOORING TYPES</b> Material: <input type="text" value="VSF"/> Base: <input type="text" value="FCB"/>	<b>ROOM ACCESSORIES</b> <input checked="" type="checkbox"/> Coat Hooks <input type="checkbox"/> Ceiling Lift <input checked="" type="checkbox"/> Magnetic Whiteboard <input type="checkbox"/> Mirror <input type="checkbox"/> Infant Change Table <input type="checkbox"/> Privacy Curtain
---	---	---	--	--

- LEGEND:**
- WALL AND CEILING LEGEND:**
- AC Architectural Ceiling
  - ACT Acoustic Ceiling Tile
  - ACT-C Cleanroom
  - ARGB Abuse-Resistant Gypsum Board
  - GB Gypsum Board
  - IRGB Impact-Resistant Gypsum Board
  - KLCT Kitchen Lay-in Ceiling Tile
  - MMRGB Moisture and Mould-Resistant Gypsum Board
  - SACT Security Acoustic Ceiling Tile
- WALL FINISHES LEGEND:**
- EWC Epoxy Wall Coating
  - HPC High Performance Coating
  - PT Paint
- CEILING FINISHES LEGEND:**
- ECC Epoxy Ceiling Coating
  - HPC High Performance Coating
  - PF Prefinished
  - PT Paint
- WALL PROTECTION LEGEND:**
- ESRP Extruded Semi-Rigid PVCu Panel
  - FRL Fibre Reinforced Laminate
  - FRP Fibreglass Reinforced Plastic
  - PVV Protective Vinyl Wallcovering
  - RHIS Rigid High Impact Sheet
  - WSSP Wetwall Solid Surface Panel
  - WWW Wetroom Vinyl Wallcovering
- FLOOR FINISHES LEGEND:**
- CFS Concrete Floor Sealer
  - EFC Epoxy Floor Coating
  - PFC Polyurethane Floor Coating
  - RAF Rubber Athletic Flooring
  - RSF Rubber Sheet Flooring
  - SCF Seamless Cushioned Flooring
  - SDRF Static-Dissipative Rubber Sheet Flooring
  - SDVF Static-Dissipative Vinyl Sheet Flooring
  - VSF Vinyl Sheet Flooring
  - WSVF Wetroom Safety Vinyl Sheet Flooring
- FLOOR BASE LEGEND:**
- FCB Flash Cove Base
  - RB Rubber Base
  - SCF Seamless Cushioned Flooring

**DOORS**

Types:

Type	Qty	Size (mm)	Material	Finish	Side Lt.	Blinds	Protect.	Privacy Film	Function	Card Reader	Mag Lock	Auto Opener	Hold Open	Hinges	Accessory 1	Accessory 2	Accessory 3	Closer
C	1	915 x 2135	Solid Core	FRL	<input checked="" type="checkbox"/>	<input type="checkbox"/>	2 High	<input checked="" type="checkbox"/>	Passage	<input type="checkbox"/>	<input type="checkbox"/>	<input checked="" type="checkbox"/>	<input type="checkbox"/>	Butt Hinge	Elec. Strike			Surface

Door Remarks:  Security Grille  Anti-barricade strategy

**MILLWORK AND SPECIALTY CASEWORK**

Storage Requirements:

**UPPER UNITS**

- U1
- U2
- U3
- U4
- U5
- U6
- U7
- U8

**LOWER UNITS**

- L1
- L2
- L3
- L4
- L5
- L6
- L7
- L8
- L9
- L10
- L11
- L12

**RECEPTION/TRANSACTION COUNTER / CARE TEAM STATION DESK**

- TC1
- TC2

**UTILITY SINK AND COUNTER UNIT**

- UC1

**FULL-HEIGHT CABINETS**

- C1
- C2
- C3
- C4
- C5

**Legend:**

Category	Min. Length (mm)	Motorized Adjustable Height	Standing Height	Specialty Casework
3	2400	<input type="checkbox"/>	<input type="checkbox"/>	<input checked="" type="checkbox"/>

**FINISHES**

Full-height Cabinet:

Upper Millwork:

Countertop:

Lower Millwork:

Shelf:

Remarks: Refer to Schedule 1, Section 6.12 (Division 12) for Specialty Casework. Items indicated are diagrammatic, provide specialty casework appropriate for the specific and specialized functions to be performed in the space and to accommodate Equipment. Provide powder coated finish.

**MECHANICAL REQUIREMENTS**

**PLUMBING**

Hand Hygiene Sink:	Lavatory:	Kitchen Sink:	Seamless Kitchen Sink:	Utility / Process Sink:	Scrub Sink:	Floor Sink:
				1		

Plumbing Remarks: HHS is to be located in corridor outside Micro lab. Alcove to be added for HHS.

**Other Fixtures:**

- Shower
- Tub
- Ice Maker
- Water Closet
- Instantaneous Hot Water
- Eyewash Station
- Eyewash/Shower Station
- Emergency Shower
- Flush Rim Sink
- Floor Drain
- Water Bottle Refill Station

Other:

**MED / NON-MED GASES**

Oxygen:	Medical Air:	Medical Vacuum:	Nitrous Oxide:	CO2:	AGSS:	Nitrogen:	Laboratory Air:	Laboratory Vacuum:	Utility Compressed Air:
							1		

Gas Remarks: Provide the following gasses. CA, He, Ar, N2.

**Appendix 1B Minimum Room Requirements**

Room Name:

Program Number(s):

1.	M1.24	7.		13.		19.		25.		31.		37.		43.
2.		8.		14.		20.		26.		32.		38.		44.
3.		9.		15.		21.		27.		33.		39.		45.
4.		10.		16.		22.		28.		34.		40.		46.
5.		11.		17.		23.		29.		35.		41.		47.
6.		12.		18.		24.		30.		36.		42.		48.

**ARCHITECTURAL REQUIREMENTS**

<b>WALL AND CEILING</b> Wall Material: <input type="text" value="MMRGB"/> Finish: <input type="text" value="PT"/> Ceiling Material: <input type="text" value="ACT-C"/> Finish: <input type="text" value="PF"/>	<b>WALL PROTECTION</b> Type: <input type="text" value="FRP"/> <input checked="" type="checkbox"/> Corner Guards <input type="checkbox"/> Hand Rails <input type="checkbox"/> Bed Bumper / Locator Height: <input type="text" value="2185 mm"/> <input type="checkbox"/> Crash Rails <input type="checkbox"/> Chair Rail	<b>GLAZING</b> <input type="checkbox"/> Interior Glazing	<b>FLOORING TYPES</b> Material: <input type="text" value="VSF"/> Base: <input type="text" value="FCB"/>	<b>ROOM ACCESSORIES</b> <input type="checkbox"/> Coat Hooks <input type="checkbox"/> Ceiling Lift <input checked="" type="checkbox"/> Magnetic Whiteboard <input type="checkbox"/> Mirror <input type="checkbox"/> Infant Change Table <input type="checkbox"/> Privacy Curtain
--	---	---	--	---

- LEGEND:**
- WALL AND CEILING LEGEND:**
- AC Architectural Ceiling
  - ACT Acoustic Ceiling Tile
  - ACT-C Cleanroom
  - ARGB Abuse-Resistant Gypsum Board
  - GB Gypsum Board
  - IRGB Impact-Resistant Gypsum Board
  - KLCT Kitchen Lay-in Ceiling Tile
  - MMRGB Moisture and Mould-Resistant Gypsum Board
  - SACT Security Acoustic Ceiling Tile
- WALL FINISHES LEGEND:**
- EWC Epoxy Wall Coating
  - HPC High Performance Coating
  - PT Paint
- CEILING FINISHES LEGEND:**
- ECC Epoxy Ceiling Coating
  - HPC High Performance Coating
  - PF Prefinished
  - PT Paint
- WALL PROTECTION LEGEND:**
- ESRP Extruded Semi-Rigid PVCu Panel
  - FRL Fibre Reinforced Laminate
  - FRP Fibreglass Reinforced Plastic
  - PVV Protective Vinyl Wallcovering
  - RHIS Rigid High Impact Sheet
  - WSSP Wetwall Solid Surface Panel
  - WVV Wetroom Vinyl Wallcovering
- FLOOR FINISHES LEGEND:**
- CFS Concrete Floor Sealer
  - EFC Epoxy Floor Coating
  - PFC Polyurethane Floor Coating
  - RAF Rubber Athletic Flooring
  - RSF Rubber Sheet Flooring
  - SCF Seamless Cushioned Flooring
  - SDRF Static-Dissipative Rubber Sheet Flooring
  - SDVF Static-Dissipative Vinyl Sheet Flooring
  - VSF Vinyl Sheet Flooring
  - WSVF Wetroom Safety Vinyl Sheet Flooring
- FLOOR BASE LEGEND:**
- FCB Flash Cove Base
  - RB Rubber Base
  - SCF Seamless Cushioned Flooring

**DOORS**

Types:

Type	Qty	Size (mm)	Material	Finish	Side Lt.	Blinds	Protect.	Privacy Film	Function	Card Reader	Mag Lock	Auto Opener	Hold Open	Hinges	Accessory 1	Accessory 2	Accessory 3	Closer
C	1	1065 x 2135	Solid Core	FRL	<input type="checkbox"/>	<input type="checkbox"/>	2 High	<input type="checkbox"/>	Passage	<input type="checkbox"/>	<input type="checkbox"/>	<input type="checkbox"/>	<input type="checkbox"/>	Butt Hinge				Concealed

Door Remarks:  Security Grille  Anti-barricade strategy

**MILLWORK AND SPECIALTY CASEWORK**

Storage Requirements:

**UPPER UNITS** (U1-U8)  U1  U2  U3  U4  U5  U6  U7  U8

**LOWER UNITS** (L1-L9)  L1  L2  L3  L4  L5  L6  L7  L8  L9

**RECEPTION/TRANSACTION COUNTER / CARE TEAM STATION DESK** (TC1, TC2)  TC1  TC2

**UTILITY SINK AND COUNTER UNIT** (UC1)  UC1

**FINISHES**

Full-height Cabinet:

Upper Millwork:

Countertop:

Lower Millwork:

Shelf:

Remarks:

Category	Min. Length (mm)	Motorized Adjustable Height	Standing Height	Specialty Casework
3	1800	<input type="checkbox"/>	<input type="checkbox"/>	<input type="checkbox"/>

**MECHANICAL REQUIREMENTS**

<b>PLUMBING</b> (Quantity) Hand Hygiene Sink: <input type="text"/> Lavatory: <input type="text"/> Kitchen Sink: <input type="text"/> Seamless Kitchen Sink: <input type="text"/> Utility / Process Sink: <input type="text"/> Scrub Sink: <input type="text"/> Floor Sink: <input type="text"/> Plumbing Remarks: <input type="text"/>	Other Fixtures: <input type="checkbox"/> Shower <input type="checkbox"/> Tub <input type="checkbox"/> Ice Maker <input type="checkbox"/> Water Closet <input type="checkbox"/> Instantaneous Hot Water <input type="checkbox"/> Eyewash Station <input type="checkbox"/> Eyewash/Shower Station <input type="checkbox"/> Emergency Shower <input type="checkbox"/> Flush Rim Sink <input type="checkbox"/> Floor Drain <input type="checkbox"/> Water Bottle Refill Station Other: <input type="text"/>	<b>MED / NON-MED GASES</b> (Quantity) Oxygen: <input type="text"/> Medical Air: <input type="text"/> Medical Vacuum: <input type="text"/> Nitrous Oxide: <input type="text"/> CO2: <input type="text"/> AGSS: <input type="text"/> Nitrogen: <input type="text"/> Laboratory Air: <input type="text" value="2"/> Laboratory Vacuum: <input type="text"/> Utility Compressed Air: <input type="text"/> Gas Remarks: <input type="text"/>
--	--	---

**Appendix 1B Minimum Room Requirements**

Room Name:

Program Number(s):

1. M2.15	7.	13.	19.	25.	31.	37.	43.
2.	8.	14.	20.	26.	32.	38.	44.
3.	9.	15.	21.	27.	33.	39.	45.
4.	10.	16.	22.	28.	34.	40.	46.
5.	11.	17.	23.	29.	35.	41.	47.
6.	12.	18.	24.	30.	36.	42.	48.

**ARCHITECTURAL REQUIREMENTS**

<b>WALL AND CEILING</b> Wall Material: <input type="text" value="ARGB 1.2m AFF, GB above"/> Finish: <input type="text" value="EWC"/> Ceiling Material: <input type="text" value="ACT"/> Finish: <input type="text" value="PF"/>	<b>WALL PROTECTION</b> Type: <input type="text" value="FRP"/> <input checked="" type="checkbox"/> Corner Guards <input type="checkbox"/> Hand Rails <input type="checkbox"/> Bed Bumper / Locator Height: <input type="text" value="2185 mm"/> <input type="checkbox"/> Crash Rails <input type="checkbox"/> Chair Rail	<b>GLAZING</b> <input type="checkbox"/> Interior Glazing	<b>FLOORING TYPES</b> Material: <input type="text" value="VSF"/> Base: <input type="text" value="FCB"/>	<b>ROOM ACCESSORIES</b> <input checked="" type="checkbox"/> Coat Hooks <input type="checkbox"/> Ceiling Lift <input type="checkbox"/> Magnetic Whiteboard <input type="checkbox"/> Mirror <input type="checkbox"/> Infant Change Table <input type="checkbox"/> Privacy Curtain
---	---	---	--	---

- LEGEND:**
- WALL AND CEILING LEGEND:**
- AC Architectural Ceiling
  - ACT Acoustic Ceiling Tile
  - ACT-C Cleanroom
  - ARGB Abuse-Resistant Gypsum Board
  - GB Gypsum Board
  - IRGB Impact-Resistant Gypsum Board
  - KLCT Kitchen Lay-in Ceiling Tile
  - MMRGB Moisture and Mould-Resistant Gypsum Board
  - SACT Security Acoustic Ceiling Tile
- WALL FINISHES LEGEND:**
- EWC Epoxy Wall Coating
  - HPC High Performance Coating
  - PT Paint
- CEILING FINISHES LEGEND:**
- ECC Epoxy Ceiling Coating
  - HPC High Performance Coating
  - PF Prefinished
  - PT Paint
- WALL PROTECTION LEGEND:**
- ESRP Extruded Semi-Rigid PVCu Panel
  - FRL Fibre Reinforced Laminate
  - FRP Fibreglass Reinforced Plastic
  - PVV Protective Vinyl Wallcovering
  - RHIS Rigid High Impact Sheet
  - WSSP Wetwall Solid Surface Panel
  - WVV Wetroom Vinyl Wallcovering
- FLOOR FINISHES LEGEND:**
- CFS Concrete Floor Sealer
  - EFC Epoxy Floor Coating
  - PFC Polyurethane Floor Coating
  - RAF Rubber Athletic Flooring
  - RSF Rubber Sheet Flooring
  - SCF Seamless Cushioned Flooring
  - SDRF Static-Dissipative Rubber Sheet Flooring
  - SDVF Static-Dissipative Vinyl Sheet Flooring
  - VSF Vinyl Sheet Flooring
  - WSVF Wetroom Safety Vinyl Sheet Flooring
- FLOOR BASE LEGEND:**
- FCB Flash Cove Base
  - RB Rubber Base
  - SCF Seamless Cushioned Flooring

**DOORS**

Types:

Type	Qty	Size (mm)	Material	Finish	Side Lt.	Blinds	Protect.	Privacy Film	Function	Card Reader	Mag Lock	Auto Opener	Hold Open	Hinges	Accessory 1	Accessory 2	Accessory 3	Closer
A	1	1220 x 2135	Solid Core	FRL	<input type="checkbox"/>	<input type="checkbox"/>	2 High	<input type="checkbox"/>	Classroom	<input type="checkbox"/>	<input type="checkbox"/>	<input type="checkbox"/>	<input type="checkbox"/>	Butt Hinge				Surface

**DOOR REMARKS:**

Security Grille  
 Anti-barricade strategy

**MILLWORK AND SPECIALTY CASEWORK**

**UPPER UNITS** U1-U8

**LOWER UNITS** L1-L12

**RECEPTION/TRANSACTION COUNTER / CARE TEAM STATION DESK** TC1-TC2

**UTILITY SINK AND COUNTER UNIT** UC1

**Storage Requirements:**

**FINISHES**

Full-height Cabinet:   
 Upper Millwork:   
 Countertop:   
 Lower Millwork:   
 Shelf:

**Remarks:**

**MECHANICAL REQUIREMENTS**

<b>PLUMBING</b> (Quantity) Hand Hygiene Sink: <input type="text"/> Lavatory: <input type="text"/> Kitchen Sink: <input type="text"/> Seamless Kitchen Sink: <input type="text"/> Utility / Process Sink: <input type="text"/> Scrub Sink: <input type="text"/> Floor Sink: <input type="text"/> Plumbing Remarks: <input type="text"/>	Other Fixtures: <input type="checkbox"/> Shower <input type="checkbox"/> Tub <input type="checkbox"/> Ice Maker <input type="checkbox"/> Water Closet <input type="checkbox"/> Instantaneous Hot Water <input type="checkbox"/> Eyewash Station <input type="checkbox"/> Eyewash/Shower Station <input type="checkbox"/> Emergency Shower <input type="checkbox"/> Flush Rim Sink <input type="checkbox"/> Floor Drain <input type="checkbox"/> Water Bottle Refill Station Other: <input type="text"/>	<b>MED / NON-MED GASES</b> (Quantity) Oxygen: <input type="text" value="1"/> Medical Air: <input type="text" value="1"/> Medical Vacuum: <input type="text" value="1"/> Nitrous Oxide: <input type="text"/> CO2: <input type="text"/> AGSS: <input type="text"/> Nitrogen: <input type="text"/> Laboratory Air: <input type="text"/> Laboratory Vacuum: <input type="text"/> Utility Compressed Air: <input type="text"/> Gas Remarks: <input type="text"/>
---	---	---



**Appendix 1B Minimum Room Requirements**

Room Name:

Program Number(s):

1.	M2.16	7.		13.		19.		25.		31.		37.		43.
2.		8.		14.		20.		26.		32.		38.		44.
3.		9.		15.		21.		27.		33.		39.		45.
4.		10.		16.		22.		28.		34.		40.		46.
5.		11.		17.		23.		29.		35.		41.		47.
6.		12.		18.		24.		30.		36.		42.		48.

**ARCHITECTURAL REQUIREMENTS**

<b>WALL AND CEILING</b> Wall Material: <input type="text" value="ARGB 1.2m AFF, GB above"/> Finish: <input type="text" value="PT"/> Ceiling Material: <input type="text" value="ACT"/> Finish: <input type="text" value="PF"/>		<b>WALL PROTECTION</b> Type: <input type="text" value="PVW"/> <input checked="" type="checkbox"/> Corner Guards <input type="checkbox"/> Hand Rails <input checked="" type="checkbox"/> Bed Bumper / Locator Height: <input type="text" value="1600 mm"/> <input type="checkbox"/> Crash Rails <input type="checkbox"/> Chair Rail		<b>GLAZING</b> <input type="checkbox"/> Interior Glazing		<b>FLOORING TYPES</b> Material: <input type="text" value="VSF"/> Base: <input type="text" value="FCB"/>		<b>ROOM ACCESSORIES</b> <input type="checkbox"/> Coat Hooks <input checked="" type="checkbox"/> Ceiling Lift <input type="checkbox"/> Magnetic Whiteboard <input checked="" type="checkbox"/> Mirror <input type="checkbox"/> Infant Change Table <input type="checkbox"/> Privacy Curtain	
--	--	--	--	---	--	--	--	--	--

- LEGEND:**
- WALL AND CEILING LEGEND:**
- AC Architectural Ceiling
  - ACT Acoustic Ceiling Tile
  - ACT-C Cleanroom
  - ARGB Abuse-Resistant Gypsum Board
  - GB Gypsum Board
  - IRGB Impact-Resistant Gypsum Board
  - KLCT Kitchen Lay-in Ceiling Tile
  - MMRGB Moisture and Mould-Resistant Gypsum Board
  - SACT Security Acoustic Ceiling Tile
- WALL FINISHES LEGEND:**
- EWC Epoxy Wall Coating
  - HPC High Performance Coating
  - PT Paint
- CEILING FINISHES LEGEND:**
- ECC Epoxy Ceiling Coating
  - HPC High Performance Coating
  - PF Prefinished
  - PT Paint
- WALL PROTECTION LEGEND:**
- ESRP Extruded Semi-Rigid PVCu Panel
  - FRL Fibre Reinforced Laminate
  - FRP Fibreglass Reinforced Plastic
  - PVW Protective Vinyl Wallcovering
  - RHIS Rigid High Impact Sheet
  - WSSP Wetwall Solid Surface Panel
  - WVV Wetroom Vinyl Wallcovering
- FLOOR FINISHES LEGEND:**
- CFS Concrete Floor Sealer
  - EFC Epoxy Floor Coating
  - PFC Polyurethane Floor Coating
  - RAF Rubber Athletic Flooring
  - RSF Rubber Sheet Flooring
  - SCF Seamless Cushioned Flooring
  - SDRF Static-Dissipative Rubber Sheet Flooring
  - SDVF Static-Dissipative Vinyl Sheet Flooring
  - VSF Vinyl Sheet Flooring
  - WSVF Wetroom Safety Vinyl Sheet Flooring
- FLOOR BASE LEGEND:**
- FCB Flash Cove Base
  - RB Rubber Base
  - SCF Seamless Cushioned Flooring

**DOORS**

Types:

Note: for Type F doors, the door panels will be approximately 465/1065 unless otherwise required by the Authority

Door Remarks:  Security Grille  Anti-barricade strategy

Type	Qty	Size (mm)	Material	Finish	Side Lt.	Blinds	Protect.	Privacy Film	Function	Card Reader	Mag Lock	Auto Opener	Hold Open	Hinges	Accessory 1	Accessory 2	Accessory 3	Closer
F	1	1530 x 2135	Solid Core	FRL	<input type="checkbox"/>	<input type="checkbox"/>	2 High	<input type="checkbox"/>	Classroom	<input type="checkbox"/>	<input type="checkbox"/>	<input type="checkbox"/>	<input type="checkbox"/>	Butt Hinge	Astragal	Flush Bolt		Concealed

**MILLWORK AND SPECIALTY CASEWORK**

Storage Requirements:

**UPPER UNITS** U1-U8  U1  U2  U3  U4  U5  U6  U7  U8

**SHELF** S1  S1

**LOWER UNITS** L1-L12  L1  L2  L3  L4  L4  L5  L6  L7  L8  L9  L10  L11  L12

**RECEPTION/TRANSACTION COUNTER / CARE TEAM STATION DESK** TC1  TC2

**UTILITY SINK AND COUNTER UNIT** UC1

**FULL-HEIGHT CABINETS** C1-C5  C1  C2  C3  C4  C5

**Legend:**

Category	Min. Length (mm)	Motorized Adjustable Height	Standing Height	Specialty Casework
3	2400	<input type="checkbox"/>	<input checked="" type="checkbox"/>	<input type="checkbox"/>

**FINISHES**

Full-height Cabinet:   
 Upper Millwork:   
 Countertop:   
 Lower Millwork:   
 Shelf:

Remarks:

**MECHANICAL REQUIREMENTS**

**PLUMBING** (Quantity)

Hygiene Sink:	Lavatory:	Kitchen Sink:	Seamless Kitchen Sink:	Utility / Process Sink:	Scrub Sink:	Floor Sink:
				1		

Plumbing Remarks:

**Other Fixtures:**

- Shower
- Tub
- Ice Maker
- Water Closet
- Instantaneous Hot Water
- Ewewash Station
- Eyewash/Shower Station
- Emergency Shower
- Flush Rim Sink
- Floor Drain
- Water Bottle Refill Station

Other:

**MED / NON-MED GASES** (Quantity)

Oxygen:	Medical Air:	Medical Vacuum:	Nitrous Oxide:	CO2:	AGSS:	Nitrogen:	Laboratory Air:	Laboratory Vacuum:	Utility Compressed Air:
4	2	4							

Gas Remarks:

**Appendix 1B Minimum Room Requirements**

Room Name:

Program Number(s):

1. M1.22	7.	13.	19.	25.	31.	37.	43.
2.	8.	14.	20.	26.	32.	38.	44.
3.	9.	15.	21.	27.	33.	39.	45.
4.	10.	16.	22.	28.	34.	40.	46.
5.	11.	17.	23.	29.	35.	41.	47.
6.	12.	18.	24.	30.	36.	42.	48.

**ARCHITECTURAL REQUIREMENTS**

<b>WALL AND CEILING</b> Wall Material: <input type="text" value="ARGB 1.2m AFF, GB above"/> Finish: <input type="text" value="EWC"/> Ceiling Material: <input type="text" value="ACT-C"/> Finish: <input type="text" value="PF"/>	<b>WALL PROTECTION</b> Type: <input type="text" value="ESRP"/> <input checked="" type="checkbox"/> Corner Guards <input type="checkbox"/> Hand Rails <input type="checkbox"/> Bed Bumper / Locator Height: <input type="text" value="2185 mm"/> <input type="checkbox"/> Crash Rails <input type="checkbox"/> Chair Rail	<b>GLAZING</b> <input type="checkbox"/> Interior Glazing	<b>FLOORING TYPES</b> Material: <input type="text" value="SDVF"/> Base: <input type="text" value="FCB"/>	<b>ROOM ACCESSORIES</b> <input type="checkbox"/> Coat Hooks <input type="checkbox"/> Ceiling Lift <input checked="" type="checkbox"/> Magnetic Whiteboard <input type="checkbox"/> Mirror <input type="checkbox"/> Infant Change Table <input type="checkbox"/> Privacy Curtain
---	--	---	---	---

- LEGEND:**
- WALL AND CEILING LEGEND:**
- AC Architectural Ceiling
  - ACT Acoustic Ceiling Tile
  - ACT-C Cleanroom
  - ARGB Abuse-Resistant Gypsum Board
  - GB Gypsum Board
  - IRGB Impact-Resistant Gypsum Board
  - KLCT Kitchen Lay-in Ceiling Tile
  - MMRGB Moisture and Mould-Resistant Gypsum Board
  - SACT Security Acoustic Ceiling Tile
- WALL FINISHES LEGEND:**
- EWC Epoxy Wall Coating
  - HPC High Performance Coating
  - PT Paint
- CEILING FINISHES LEGEND:**
- ECC Epoxy Ceiling Coating
  - HPC High Performance Coating
  - PF Prefinished
  - PT Paint
- WALL PROTECTION LEGEND:**
- ESRP Extruded Semi-Rigid PVCu Panel
  - FRL Fibre Reinforced Laminata
  - FRP Fibreglass Reinforced Plastic
  - PVV Protective Vinyl Wallcovering
  - RHIS Rigid High Impact Sheet
  - WSSP Wetwall Solid Surface Panel
  - WWW Wetroom Vinyl Wallcovering
- FLOOR FINISHES LEGEND:**
- CFS Concrete Floor Sealer
  - EFC Epoxy Floor Coating
  - PFC Polyurethane Floor Coating
  - RAF Rubber Athletic Flooring
  - RSF Rubber Sheet Flooring
  - SCF Seamless Cushioned Flooring
  - SDRF Static-Dissipative Rubber Sheet Flooring
  - SDVF Static-Dissipative Vinyl Sheet Flooring
  - VSF Vinyl Sheet Flooring
  - WSVF Wetroom Safety Vinyl Sheet Flooring
- FLOOR BASE LEGEND:**
- FCB Flash Cove Base
  - RB Rubber Base
  - SCF Seamless Cushioned Flooring

**DOORS**

Types:

Type	Qty	Size (mm)	Material	Finish	Side Lt.	Blinds	Protect.	Privacy Film	Function	Card Reader	Mag Lock	Auto Opener	Hold Open	Hinges	Accessory 1	Accessory 2	Accessory 3	Closer
C	1	1065 x 2135	Solid Core	FRL	<input type="checkbox"/>	<input type="checkbox"/>		<input type="checkbox"/>	Push/Pull	<input checked="" type="checkbox"/>	<input checked="" type="checkbox"/>	<input checked="" type="checkbox"/>	<input type="checkbox"/>	Butt Hinge	Elec. Strike			Surface

Door Remarks:  Security Grille  Anti-barricade strategy

**MILLWORK AND SPECIALTY CASEWORK**

**UPPER UNITS**

**LOWER UNITS**

**RECEPTION/TRANSACTION COUNTER / CARE TEAM STATION DESK**

**UTILITY SINK AND COUNTER UNIT**

**Storage Requirements:**

Category	Min. Length (mm)	Motorized Adjustable Height	Standing Height	Specialty Casework
3	6000	<input type="checkbox"/>	<input type="checkbox"/>	<input checked="" type="checkbox"/>

**FINISHES**

Full-height Cabinet:

Upper Millwork:

Countertop:

Lower Millwork:

Shelf:

Remarks: Refer to Schedule 1, Section 6.12 (Division 12) for Specialty Casework. Items indicated are diagrammatic, provide specialty casework appropriate for the specific and specialized functions to be performed in the space and to accommodate Equipment. Provide benchtop work space, and clean supply storage. To provide powder coated finish.

**MECHANICAL REQUIREMENTS**

<b>PLUMBING</b> (Quantity) Hand Hygiene Sink: <input type="text"/> Lavatory: <input type="text"/> Kitchen Sink: <input type="text"/> Seamless Kitchen Sink: <input type="text"/> Utility / Process Sink: <input type="text" value="1"/> Scrub Sink: <input type="text"/> Floor Sink: <input type="text"/> Plumbing Remarks: <input type="text" value="Provide single basin utility sink."/>	Other Fixtures: <input type="checkbox"/> Shower <input type="checkbox"/> Tub <input type="checkbox"/> Ice Maker <input type="checkbox"/> Water Closet <input type="checkbox"/> Instantaneous Hot Water <input checked="" type="checkbox"/> Eyewash Station <input type="checkbox"/> Eyewash/Shower Station <input type="checkbox"/> Emergency Shower <input type="checkbox"/> Flush Rim Sink <input checked="" type="checkbox"/> Floor Drain <input type="checkbox"/> Water Bottle Refill Station Other: <input type="text"/>	<b>MED / NON-MED GASES</b> (Quantity) Oxygen: <input type="text"/> Medical Air: <input type="text"/> Medical Vacuum: <input type="text"/> Nitrous Oxide: <input type="text"/> CO2: <input type="text"/> AGSS: <input type="text"/> Nitrogen: <input type="text"/> Laboratory Air: <input type="text" value="1"/> Laboratory Vacuum: <input type="text"/> Utility Compressed Air: <input type="text"/> Gas Remarks: <input type="text" value="Provide the following gasses. CA, H2, N2, He, Ar, Ar + 10% Me."/>
--	---	--

**Appendix 1B Minimum Room Requirements**

Room Name:

Program Number(s):

1. M1.23	7.	13.	19.	25.	31.	37.	43.
2.	8.	14.	20.	26.	32.	38.	44.
3.	9.	15.	21.	27.	33.	39.	45.
4.	10.	16.	22.	28.	34.	40.	46.
5.	11.	17.	23.	29.	35.	41.	47.
6.	12.	18.	24.	30.	36.	42.	48.

**ARCHITECTURAL REQUIREMENTS**

<b>WALL AND CEILING</b> Wall Material: <input type="text" value="ARGB 1.2m AFF, GB above"/> Finish: <input type="text" value="EWC"/> Ceiling Material: <input type="text" value="ACT-C"/> Finish: <input type="text" value="PF"/>	<b>WALL PROTECTION</b> Type: <input type="text" value="ESRP"/> <input checked="" type="checkbox"/> Corner Guards <input type="checkbox"/> Hand Rails <input type="checkbox"/> Bed Bumper / Locator Height: <input type="text" value="2185 mm"/> <input type="checkbox"/> Crash Rails <input type="checkbox"/> Chair Rail	<b>GLAZING</b> <input type="checkbox"/> Interior Glazing	<b>FLOORING TYPES</b> Material: <input type="text" value="SDVF"/> Base: <input type="text" value="FCB"/>	<b>ROOM ACCESSORIES</b> <input type="checkbox"/> Coat Hooks <input type="checkbox"/> Ceiling Lift <input checked="" type="checkbox"/> Magnetic Whiteboard <input type="checkbox"/> Mirror <input type="checkbox"/> Infant Change Table <input type="checkbox"/> Privacy Curtain
---	--	---	---	---

- LEGEND:**
- WALL AND CEILING LEGEND:**
- AC Architectural Ceiling
  - ACT Acoustic Ceiling Tile
  - ACT-C Cleanroom
  - ARGB Abuse-Resistant Gypsum Board
  - GB Gypsum Board
  - IRGB Impact-Resistant Gypsum Board
  - KLCT Kitchen Lay-in Ceiling Tile
  - MMRGB Moisture and Mould-Resistant Gypsum Board
  - SACT Security Acoustic Ceiling Tile
- WALL FINISHES LEGEND:**
- EWC Epoxy Wall Coating
  - HPC High Performance Coating
  - PT Paint
- CEILING FINISHES LEGEND:**
- ECC Epoxy Ceiling Coating
  - HPC High Performance Coating
  - PF Prefinished
  - PT Paint
- WALL PROTECTION LEGEND:**
- ESRP Extruded Semi-Rigid PVCu Panel
  - FRL Fibre Reinforced Laminata
  - FRP Fibreglass Reinforced Plastic
  - PVV Protective Vinyl Wallcovering
  - RHIS Rigid High Impact Sheet
  - WSSP Wetwall Solid Surface Panel
  - WWW Wetroom Vinyl Wallcovering
- FLOOR FINISHES LEGEND:**
- CFS Concrete Floor Sealer
  - EFC Epoxy Floor Coating
  - PFC Polyurethane Floor Coating
  - RAF Rubber Athletic Flooring
  - RSF Rubber Sheet Flooring
  - SCF Seamless Cushioned Flooring
  - SDRF Static-Dissipative Rubber Sheet Flooring
  - SDVF Static-Dissipative Vinyl Sheet Flooring
  - VSF Vinyl Sheet Flooring
  - WSVF Wetroom Safety Vinyl Sheet Flooring
- FLOOR BASE LEGEND:**
- FCB Flash Cove Base
  - RB Rubber Base
  - SCF Seamless Cushioned Flooring

**DOORS**

Types:

Type	Qty	Size (mm)	Material	Finish	Side Lt.	Blinds	Protect.	Privacy Film	Function	Card Reader	Mag Lock	Auto Opener	Hold Open	Hinges	Accessory 1	Accessory 2	Accessory 3	Closer
C	1	1065 x 2135	Solid Core	FRL	<input type="checkbox"/>	<input type="checkbox"/>		<input type="checkbox"/>	Push/Pull	<input checked="" type="checkbox"/>	<input checked="" type="checkbox"/>	<input checked="" type="checkbox"/>	<input type="checkbox"/>	Butt Hinge	Elec. Strike			Surface

Door Remarks:  Security Grille  Anti-barricade strategy

**MILLWORK AND SPECIALTY CASEWORK**

Storage Requirements:

**UPPER UNITS**

**LOWER UNITS**

**RECEPTION/TRANSACTION COUNTER / CARE TEAM STATION DESK**

**UTILITY SINK AND COUNTER UNIT**

**FULL-HEIGHT CABINETS**

Category	Min. Length (mm)	Motorized Adjustable Height	Standing Height	Specialty Casework
3	4200	<input type="checkbox"/>	<input type="checkbox"/>	<input checked="" type="checkbox"/>

**FINISHES**

Full-height Cabinet:

Upper Millwork:

Countertop:

Lower Millwork:

Shelf:

Remarks: Refer to Schedule 1, Section 6.12 (Division 12) for Specialty Casework. Items indicated are diagrammatic, provide specialty casework appropriate for the specific and specialized functions to be performed in the space and to accommodate Equipment. Provide benchtop work space, and clean supply storage. To provide powder coated finish.

**MECHANICAL REQUIREMENTS**

<b>PLUMBING</b> (Quantity) Hygiene Sink: <input type="text"/> Lavatory: <input type="text"/> Kitchen Sink: <input type="text"/> Seamless Kitchen Sink: <input type="text"/> Utility / Process Sink: <input type="text" value="1"/> Scrub Sink: <input type="text"/> Floor Sink: <input type="text"/> Plumbing Remarks: <input type="text" value="Provide single basin utility sink."/>	Other Fixtures: <input type="checkbox"/> Shower <input type="checkbox"/> Tub <input type="checkbox"/> Ice Maker <input type="checkbox"/> Water Closet <input type="checkbox"/> Instantaneous Hot Water <input checked="" type="checkbox"/> Eyewash Station <input type="checkbox"/> Eyewash/Shower Station <input type="checkbox"/> Emergency Shower <input type="checkbox"/> Flush Rim Sink <input checked="" type="checkbox"/> Floor Drain <input type="checkbox"/> Water Bottle Refill Station Other: <input type="text"/>	<b>MED / NON-MED GASES</b> (Quantity) Oxygen: <input type="text"/> Medical Air: <input type="text"/> Medical Vacuum: <input type="text"/> Nitrous Oxide: <input type="text"/> CO2: <input type="text"/> AGSS: <input type="text"/> Nitrogen: <input type="text"/> Laboratory Air: <input type="text" value="1"/> Laboratory Vacuum: <input type="text"/> Utility Compressed Air: <input type="text"/> Gas Remarks: <input type="text" value="Hot cell serving clean room requires the following gas connections. CA, N2, H3, Ar. Clean rooms will be tied to CA vacuum piped system for radioactive release decay mode."/>
--	--	--



**Appendix 1B Minimum Room Requirements**

Room Name:

Program Number(s):

1. M2.07	7.	13.	19.	25.	31.	37.	43.
2.	8.	14.	20.	26.	32.	38.	44.
3.	9.	15.	21.	27.	33.	39.	45.
4.	10.	16.	22.	28.	34.	40.	46.
5.	11.	17.	23.	29.	35.	41.	47.
6.	12.	18.	24.	30.	36.	42.	48.

**ARCHITECTURAL REQUIREMENTS**

<b>WALL AND CEILING</b> Wall Material: <input type="text" value="ARGB 1.2m AFF, GB above"/> Finish: <input type="text" value="PT"/> Ceiling Material: <input type="text" value="ACT"/> Finish: <input type="text" value="PF"/>	<b>WALL PROTECTION</b> Type: <input type="text"/> Height: <input type="text"/> <input checked="" type="checkbox"/> Corner Guards <input type="checkbox"/> Hand Rails <input type="checkbox"/> Bed Bumper / Locator <input type="checkbox"/> Crash Rails <input checked="" type="checkbox"/> Chair Rail	<b>GLAZING</b> <input type="checkbox"/> Interior Glazing	<b>FLOORING TYPES</b> Material: <input type="text" value="VSF"/> Base: <input type="text" value="FCB"/>	<b>ROOM ACCESSORIES</b> <input checked="" type="checkbox"/> Coat Hooks <input type="checkbox"/> Ceiling Lift <input checked="" type="checkbox"/> Magnetic Whiteboard <input type="checkbox"/> Mirror <input type="checkbox"/> Infant Change Table <input type="checkbox"/> Privacy Curtain
--	---	---	--	--

- LEGEND:**
- WALL AND CEILING LEGEND:**
- AC Architectural Ceiling
  - ACT Acoustic Ceiling Tile
  - ACT-C Cleanroom
  - ARGB Abuse-Resistant Gypsum Board
  - GB Gypsum Board
  - IRGB Impact-Resistant Gypsum Board
  - KLCT Kitchen Lay-in Ceiling Tile
  - MMRGB Moisture and Mould-Resistant Gypsum Board
  - SACT Security Acoustic Ceiling Tile
- WALL FINISHES LEGEND:**
- EWC Epoxy Wall Coating
  - HPC High Performance Coating
  - PT Paint
- CEILING FINISHES LEGEND:**
- ECC Epoxy Ceiling Coating
  - HPC High Performance Coating
  - PF Prefinished
  - PT Paint
- WALL PROTECTION LEGEND:**
- ESRP Extruded Semi-Rigid PVCu Panel
  - FRL Fibre Reinforced Laminate
  - FRP Fibreglass Reinforced Plastic
  - PVV Protective Vinyl Wallcovering
  - RHIS Rigid High Impact Sheet
  - WSSP Wetwall Solid Surface Panel
  - WVV Wetroom Vinyl Wallcovering
- FLOOR FINISHES LEGEND:**
- CFS Concrete Floor Sealer
  - EFC Epoxy Floor Coating
  - PFC Polyurethane Floor Coating
  - RAF Rubber Athletic Flooring
  - RSF Rubber Sheet Flooring
  - SCF Seamless Cushioned Flooring
  - SDRF Static-Dissipative Rubber Sheet Flooring
  - SDVF Static-Dissipative Vinyl Sheet Flooring
  - VSF Vinyl Sheet Flooring
  - WSVF Wetroom Safety Vinyl Sheet Flooring
- FLOOR BASE LEGEND:**
- FCB Flash Cove Base
  - RB Rubber Base
  - SCF Seamless Cushioned Flooring

**DOORS**

Types:

Type	Qty	Size (mm)	Material	Finish	Side Lt.	Blinds	Protect.	Privacy Film	Function	Card Reader	Mag Lock	Auto Opener	Hold Open	Hinges	Accessory 1	Accessory 2	Accessory 3	Closer
A	1	915 x 2135	Solid Core	FRL	<input type="checkbox"/>	<input checked="" type="checkbox"/>	1 Low	<input type="checkbox"/>	Storeroom	<input checked="" type="checkbox"/>	<input type="checkbox"/>	<input type="checkbox"/>	<input type="checkbox"/>	Butt Hinge				Surface

Door Remarks:

Security Grille  
 Anti-barricade strategy

**MILLWORK AND SPECIALTY CASEWORK**

**UPPER UNITS** (U1-U8) **LOWER UNITS** (L1-L9)

**RECEPTION/TRANSACTION COUNTER / CARE TEAM STATION DESK** (TC1, TC2)

**UTILITY SINK AND COUNTER UNIT** (UC1)

**Storage Requirements:**

**FINISHES**

Full-height Cabinet:   
 Upper Millwork:   
 Countertop:   
 Lower Millwork:   
 Shelf:

Remarks:

**Legend:**

Category	Min. Length (mm)	Motorized Adjustable Height	Standing Height	Specialty Casework
Category 0 - None		<input type="checkbox"/>	<input type="checkbox"/>	<input type="checkbox"/>
Category 1 - Low (1% - 4%)		<input type="checkbox"/>	<input type="checkbox"/>	<input type="checkbox"/>
Category 2 - Med (5% - 9%)		<input type="checkbox"/>	<input type="checkbox"/>	<input type="checkbox"/>
Category 3 - High (10% or Greater)		<input type="checkbox"/>	<input type="checkbox"/>	<input type="checkbox"/>

**MECHANICAL REQUIREMENTS**

<b>PLUMBING</b> (Quantity) Hand Hygiene Sink: <input type="text"/> Lavatory: <input type="text"/> Kitchen Sink: <input type="text"/> Seamless Kitchen Sink: <input type="text"/> Utility / Process Sink: <input type="text"/> Scrub Sink: <input type="text"/> Floor Sink: <input type="text"/> Plumbing Remarks: <input type="text"/>	Other Fixtures: <input type="checkbox"/> Shower <input type="checkbox"/> Tub <input type="checkbox"/> Ice Maker <input type="checkbox"/> Water Closet <input type="checkbox"/> Instantaneous Hot Water <input type="checkbox"/> Eyewash Station <input type="checkbox"/> Eyewash/Shower Station <input type="checkbox"/> Emergency Shower <input type="checkbox"/> Flush Rim Sink <input type="checkbox"/> Floor Drain <input type="checkbox"/> Water Bottle Refill Station Other: <input type="text"/>	<b>MED / NON-MED GASES</b> (Quantity) Oxygen: <input type="text"/> Medical Air: <input type="text"/> Medical Vacuum: <input type="text"/> Nitrous Oxide: <input type="text"/> CO2: <input type="text"/> AGSS: <input type="text"/> Nitrogen: <input type="text"/> Laboratory Air: <input type="text"/> Laboratory Vacuum: <input type="text"/> Utility Compressed Air: <input type="text"/> Gas Remarks: <input type="text"/>
--	--	---

# Appendix 1B Minimum Room Requirements

Room Name:

Program Number(s):

1. M1.18	7.	13.	19.	25.	31.	37.	43.
2.	8.	14.	20.	26.	32.	38.	44.
3.	9.	15.	21.	27.	33.	39.	45.
4.	10.	16.	22.	28.	34.	40.	46.
5.	11.	17.	23.	29.	35.	41.	47.
6.	12.	18.	24.	30.	36.	42.	48.

## ARCHITECTURAL REQUIREMENTS

<b>WALL AND CEILING</b> Wall Material: <input type="text" value="MMRGB"/> Finish: <input type="text" value="EWC"/> Ceiling Material: <input type="text" value="ACT"/> Finish: <input type="text" value="PF"/>	<b>WALL PROTECTION</b> Type: <input type="text" value="RHIS"/> <input checked="" type="checkbox"/> Corner Guards <input type="checkbox"/> Hand Rails <input type="checkbox"/> Bed Bumper / Locator Height: <input type="text" value="1350 mm"/> <input checked="" type="checkbox"/> Crash Rails <input type="checkbox"/> Chair Rail	<b>GLAZING</b> <input type="checkbox"/> Interior Glazing	<b>FLOORING TYPES</b> Material: <input type="text" value="VSF"/> Base: <input type="text" value="FCB"/>	<b>ROOM ACCESSORIES</b> <input type="checkbox"/> Coat Hooks <input checked="" type="checkbox"/> Ceiling Lift <input checked="" type="checkbox"/> Magnetic Whiteboard <input type="checkbox"/> Mirror <input type="checkbox"/> Infant Change Table <input type="checkbox"/> Privacy Curtain
---	---	---	--	--

- LEGEND:**
- WALL AND CEILING LEGEND:**
- AC Architectural Ceiling
  - ACT Acoustic Ceiling Tile
  - ACT-C Cleanroom
  - ARGB Abuse-Resistant Gypsum Board
  - GB Gypsum Board
  - IRGB Impact-Resistant Gypsum Board
  - KLCT Kitchen Lay-in Ceiling Tile
  - MMRGB Moisture and Mould-Resistant Gypsum Board
  - SACT Security Acoustic Ceiling Tile
- WALL FINISHES LEGEND:**
- EWC Epoxy Wall Coating
  - HPC High Performance Coating
  - PT Paint
- CEILING FINISHES LEGEND:**
- ECC Epoxy Ceiling Coating
  - HPC High Performance Coating
  - PF Prefinished
  - PT Paint
- WALL PROTECTION LEGEND:**
- ESRP Extruded Semi-Rigid PVCu Panel
  - FRL Fibre Reinforced Laminate
  - FRP Fibreglass Reinforced Plastic
  - PVV Protective Vinyl Wallcovering
  - RHIS Rigid High Impact Sheet
  - WSSP Wetwall Solid Surface Panel
  - WVV Wetroom Vinyl Wallcovering
- FLOOR FINISHES LEGEND:**
- CFS Concrete Floor Sealer
  - EFC Epoxy Floor Coating
  - PFC Polyurethane Floor Coating
  - RAF Rubber Athletic Flooring
  - RSF Rubber Sheet Flooring
  - SCF Seamless Cushioned Flooring
  - SDRF Static-Dissipative Rubber Sheet Flooring
  - SDVF Static-Dissipative Vinyl Sheet Flooring
  - VSF Vinyl Sheet Flooring
  - WSVF Wetroom Safety Vinyl Sheet Flooring
- FLOOR BASE LEGEND:**
- FCB Flash Cove Base
  - RB Rubber Base
  - SCF Seamless Cushioned Flooring

**DOORS**

Types:

Type	Qty	Size (mm)	Material	Finish	Side Lt.	Blinds	Protect.	Privacy Film	Function	Card Reader	Mag Lock	Auto Opener	Hold Open	Hinges	Accessory 1	Accessory 2	Accessory 3	Closer
A	1	1065 x 2135	Hollow Metal	Paint	<input type="checkbox"/>	<input type="checkbox"/>		<input type="checkbox"/>	Storeroom	<input checked="" type="checkbox"/>	<input type="checkbox"/>	<input checked="" type="checkbox"/>	<input checked="" type="checkbox"/>	Butt Hinge	Elec. Strike			Surface
A	1	1065 x 2135	Hollow Metal	Paint	<input type="checkbox"/>	<input type="checkbox"/>	2 High	<input type="checkbox"/>	Storeroom	<input checked="" type="checkbox"/>	<input type="checkbox"/>	<input checked="" type="checkbox"/>	<input checked="" type="checkbox"/>	Butt Hinge	Elec. Strike			Surface

Door Remarks: Provide half-door to Vestibule - Receiving (open at bottom to allow only packages to be passed through from receiving vestibule).

Security Grille  
 Anti-barricade strategy

**MILLWORK AND SPECIALTY CASEWORK**

Storage Requirements:

**UPPER UNITS** (U1-U8)

**LOWER UNITS** (L1-L12)

**RECEPTION/TRANSACTION COUNTER / CARE TEAM STATION DESK** (TC1, TC2)

**UTILITY SINK AND COUNTER UNIT** (UC1)

**SHELF** (S1)

**FULL-HEIGHT CABINETS** (C1-C5)

**Legend:**

Category	Min. Length (mm)	Motorized Adjustable Height	Standing Height	Specialty Casework
Category 0 - None		<input type="checkbox"/>	<input type="checkbox"/>	<input type="checkbox"/>
Category 1 - Low (1% - 4%)		<input type="checkbox"/>	<input type="checkbox"/>	<input type="checkbox"/>
Category 2 - Med (5% - 9%)		<input type="checkbox"/>	<input type="checkbox"/>	<input type="checkbox"/>
Category 3 - High (10% or Greater)	3	1500	<input type="checkbox"/>	<input type="checkbox"/>

**FINISHES**

Full-height Cabinet:

Upper Millwork:

Countertop:

Lower Millwork:

Shelf:

Remarks:

## MECHANICAL REQUIREMENTS

**PLUMBING**

(Quantity)

Hygiene Sink:	Lavatory:	Kitchen Sink:	Seamless Kitchen Sink:	Utility / Process Sink:	Scrub Sink:	Floor Sink:
<input type="text"/>	<input type="text"/>	<input type="text"/>	<input type="text"/>	<input type="text"/>	<input type="text"/>	<input type="text"/>

Plumbing Remarks:

**Other Fixtures:**

- Shower
- Tub
- Ice Maker
- Water Closet
- Instantaneous Hot Water
- Eyewash Station
- Eyewash/Shower Station
- Emergency Shower
- Flush Rim Sink
- Floor Drain
- Water Bottle Refill Station

Other:

**MED / NON-MED GASES**

(Quantity)

Oxygen:	Medical Air:	Medical Vacuum:	Nitrous Oxide:	CO2:	AGSS:	Nitrogen:	Laboratory Air:	Laboratory Vacuum:	Utility Compressed Air:
<input type="text"/>	<input type="text"/>	<input type="text"/>	<input type="text"/>	<input type="text"/>	<input type="text"/>	<input type="text"/>	<input type="text"/>	<input type="text"/>	<input type="text"/>

Gas Remarks:

**Appendix 1B Minimum Room Requirements**

Room Name:

Program Number(s):

1. M1.27	7.	13.	19.	25.	31.	37.	43.
2.	8.	14.	20.	26.	32.	38.	44.
3.	9.	15.	21.	27.	33.	39.	45.
4.	10.	16.	22.	28.	34.	40.	46.
5.	11.	17.	23.	29.	35.	41.	47.
6.	12.	18.	24.	30.	36.	42.	48.

**ARCHITECTURAL REQUIREMENTS**

<b>WALL AND CEILING</b> Wall Material: <input type="text" value="ARGB 1.2m AFF, GB above"/> Finish: <input type="text" value="EWC"/> Ceiling Material: <input type="text" value="GB"/> Finish: <input type="text" value="ECC"/>	<b>WALL PROTECTION</b> Type: <input type="text" value="ESRP"/> <input checked="" type="checkbox"/> Corner Guards <input type="checkbox"/> Hand Rails <input type="checkbox"/> Bed Bumper / Locator Height: <input type="text" value="2185 mm"/> <input type="checkbox"/> Crash Rails <input type="checkbox"/> Chair Rail	<b>GLAZING</b> <input type="checkbox"/> Interior Glazing	<b>FLOORING TYPES</b> Material: <input type="text" value="RSF"/> Base: <input type="text" value="FCB"/>	<b>ROOM ACCESSORIES</b> <input type="checkbox"/> Coat Hooks <input type="checkbox"/> Ceiling Lift <input checked="" type="checkbox"/> Magnetic Whiteboard <input type="checkbox"/> Mirror <input type="checkbox"/> Infant Change Table <input type="checkbox"/> Privacy Curtain
---	--	---	--	---

- LEGEND:**
- WALL AND CEILING LEGEND:**
- AC Architectural Ceiling
  - ACT Acoustic Ceiling Tile
  - ACT-C Cleanroom
  - ARGB Abuse-Resistant Gypsum Board
  - GB Gypsum Board
  - IRGB Impact-Resistant Gypsum Board
  - KLCT Kitchen Lay-in Ceiling Tile
  - MMRGB Moisture and Mould-Resistant Gypsum Board
  - SACT Security Acoustic Ceiling Tile
- WALL FINISHES LEGEND:**
- EWC Epoxy Wall Coating
  - HPC High Performance Coating
  - PT Paint
- CEILING FINISHES LEGEND:**
- ECC Epoxy Ceiling Coating
  - HPC High Performance Coating
  - PF Prefinished
  - PT Paint
- WALL PROTECTION LEGEND:**
- ESRP Extruded Semi-Rigid PVCu Panel
  - FRL Fibre Reinforced Laminate
  - FRP Fibreglass Reinforced Plastic
  - PVV Protective Vinyl Wallcovering
  - RHIS Rigid High Impact Sheet
  - WSSP Wetwall Solid Surface Panel
  - WVV Wetroom Vinyl Wallcovering
- FLOOR FINISHES LEGEND:**
- CFS Concrete Floor Sealer
  - EFC Epoxy Floor Coating
  - PFC Polyurethane Floor Coating
  - RAF Rubber Athletic Flooring
  - RSF Rubber Sheet Flooring
  - SCF Seamless Cushioned Flooring
  - SDRF Static-Dissipative Rubber Sheet Flooring
  - SDVF Static-Dissipative Vinyl Sheet Flooring
  - VSF Vinyl Sheet Flooring
  - WSVF Wetroom Safety Vinyl Sheet Flooring
- FLOOR BASE LEGEND:**
- FCB Flash Cove Base
  - RB Rubber Base
  - SCF Seamless Cushioned Flooring

**DOORS**

Types:

Type	Qty	Size (mm)	Material	Finish	Side Lt.	Blinds	Protect.	Privacy Film	Function	Card Reader	Mag Lock	Auto Opener	Hold Open	Hinges	Accessory 1	Accessory 2	Accessory 3	Closer
C	1	915 x 2135	Cleanroom	Prefinished	<input type="checkbox"/>	<input type="checkbox"/>		<input type="checkbox"/>	Push/Pull	<input type="checkbox"/>	<input checked="" type="checkbox"/>	<input checked="" type="checkbox"/>	<input type="checkbox"/>	Butt Hinge	Elec. Strike			Surface

Door Remarks:  Security Grille  Anti-barricade strategy

**MILLWORK AND SPECIALTY CASEWORK**

**UPPER UNITS** (U1-U8) **LOWER UNITS** (L1-L12) **RECEPTION/TRANSACTION COUNTER / CARE TEAM STATION DESK** (TC1-TC2) **UTILITY SINK AND COUNTER UNIT** (UC1)

Storage Requirements:

**FINISHES**

Full-height Cabinet:   
 Upper Millwork:   
 Countertop:   
 Lower Millwork:   
 Shelf:

Remarks:

**Legend:**

Category	Min. Length (mm)	Motorized Adjustable Height	Standing Height	Specialty Casework
Category 0 - None		<input type="checkbox"/>	<input type="checkbox"/>	<input type="checkbox"/>
Category 1 - Low (1% - 4%)		<input type="checkbox"/>	<input type="checkbox"/>	<input type="checkbox"/>
Category 2 - Med (5% - 9%)		<input type="checkbox"/>	<input type="checkbox"/>	<input type="checkbox"/>
Category 3 - High (10% or Greater)		<input type="checkbox"/>	<input type="checkbox"/>	<input type="checkbox"/>

**MECHANICAL REQUIREMENTS**

<b>PLUMBING</b> (Quantity) Hand Hygiene Sink: <input type="text"/> Lavatory: <input type="text"/> Kitchen Sink: <input type="text"/> Seamless Kitchen Sink: <input type="text"/> Utility / Process Sink: <input type="text"/> Scrub Sink: <input type="text"/> Floor Sink: <input type="text"/> Plumbing Remarks: <input type="text"/>	Other Fixtures: <input type="checkbox"/> Shower <input type="checkbox"/> Tub <input type="checkbox"/> Ice Maker <input type="checkbox"/> Water Closet <input type="checkbox"/> Instantaneous Hot Water <input checked="" type="checkbox"/> Eyewash Station <input type="checkbox"/> Eyewash/Shower Station <input type="checkbox"/> Emergency Shower <input type="checkbox"/> Flush Rim Sink <input checked="" type="checkbox"/> Floor Drain <input type="checkbox"/> Water Bottle Refill Station Other: <input type="text"/>	<b>MED / NON-MED GASES</b> (Quantity) Oxygen: <input type="text"/> Medical Air: <input type="text"/> Medical Vacuum: <input type="text"/> Nitrous Oxide: <input type="text"/> CO2: <input type="text"/> AGSS: <input type="text"/> Nitrogen: <input type="text"/> Laboratory Air: <input type="text" value="1"/> Laboratory Vacuum: <input type="text"/> Utility Compressed Air: <input type="text"/> Gas Remarks: <input type="text" value="Hot cell serving clean room requires the following gas connections. CA, N2, H3, Ar. Clean rooms will be tied to CA vacuum piped system for radioactive release decay mode."/>
---	--	--



# Appendix 1B Minimum Room Requirements

Room Name:

Program Number(s):

1.	M2.31	7.		13.		19.		25.		31.		37.		43.
2.		8.		14.		20.		26.		32.		38.		44.
3.		9.		15.		21.		27.		33.		39.		45.
4.		10.		16.		22.		28.		34.		40.		46.
5.		11.		17.		23.		29.		35.		41.		47.
6.		12.		18.		24.		30.		36.		42.		48.

## ARCHITECTURAL REQUIREMENTS

<b>WALL AND CEILING</b> Wall Material: <input type="text" value="ARGB 1.2m AFF, GB above"/> Finish: <input type="text" value="EWC"/> Ceiling Material: <input type="text" value="ACT"/> Finish: <input type="text" value="PF"/>		<b>WALL PROTECTION</b> Type: <input type="text" value="ESRP"/> <input checked="" type="checkbox"/> Corner Guards <input type="checkbox"/> Hand Rails <input type="checkbox"/> Bed Bumper / Locator Height: <input type="text" value="1600 mm"/> <input type="checkbox"/> Crash Rails <input type="checkbox"/> Chair Rail		<b>GLAZING</b> <input type="checkbox"/> Interior Glazing		<b>FLOORING TYPES</b> Material: <input type="text" value="WSVF"/> Base: <input type="text" value="FCB"/>		<b>ROOM ACCESSORIES</b> <input type="checkbox"/> Coat Hooks <input type="checkbox"/> Ceiling Lift <input type="checkbox"/> Magnetic Whiteboard <input type="checkbox"/> Mirror <input type="checkbox"/> Infant Change Table <input type="checkbox"/> Privacy Curtain		
---	--	--	--	---	--	---	--	--	--	--

- LEGEND:**
- WALL AND CEILING LEGEND:**
- AC Architectural Ceiling
  - ACT Acoustic Ceiling Tile
  - ACT-C Cleanroom
  - ARGB Abuse-Resistant Gypsum Board
  - GB Gypsum Board
  - IRGB Impact-Resistant Gypsum Board
  - KLCT Kitchen Lay-in Ceiling Tile
  - MMRGB Moisture and Mould-Resistant Gypsum Board
  - SACT Security Acoustic Ceiling Tile
- WALL FINISHES LEGEND:**
- EWC Epoxy Wall Coating
  - HPC High Performance Coating
  - PT Paint
- CEILING FINISHES LEGEND:**
- ECC Epoxy Ceiling Coating
  - HPC High Performance Coating
  - PF Prefinished
  - PT Paint
- WALL PROTECTION LEGEND:**
- ESRP Extruded Semi-Rigid PVCu Panel
  - FRL Fibre Reinforced Laminate
  - FRP Fibreglass Reinforced Plastic
  - PVV Protective Vinyl Wallcovering
  - RHIS Rigid High Impact Sheet
  - WSSP Wetwall Solid Surface Panel
  - WVV Wetroom Vinyl Wallcovering
- FLOOR FINISHES LEGEND:**
- CFS Concrete Floor Sealer
  - EFC Epoxy Floor Coating
  - PFC Polyurethane Floor Coating
  - RAF Rubber Athletic Flooring
  - RSF Rubber Sheet Flooring
  - SCF Seamless Cushioned Flooring
  - SDRF Static-Dissipative Rubber Sheet Flooring
  - SDVF Static-Dissipative Vinyl Sheet Flooring
  - VSF Vinyl Sheet Flooring
  - WSVF Wetroom Safety Vinyl Sheet Flooring
- FLOOR BASE LEGEND:**
- FCB Flash Cove Base
  - RB Rubber Base
  - SCF Seamless Cushioned Flooring

**DOORS**

Types:

Type	Qty	Size (mm)	Material	Finish	Side Lt.	Blinds	Protect.	Privacy Film	Function	Card Reader	Mag Lock	Auto Opener	Hold Open	Hinges	Accessory 1	Accessory 2	Accessory 3	Closer
A	1	1220 x 2135	Hollow Metal	FRL	<input type="checkbox"/>	<input type="checkbox"/>	2 High	<input type="checkbox"/>	Storeroom	<input checked="" type="checkbox"/>	<input type="checkbox"/>	<input checked="" type="checkbox"/>	<input type="checkbox"/>	Cont. Swing Clear	Elec. Strike			Surface

Door Remarks:  Security Grille  Anti-barricade strategy

**MILLWORK AND SPECIALTY CASEWORK**

Storage Requirements:

**UPPER UNITS** (U1-U8) **SHELF** (S1)

**FULL-HEIGHT CABINETS** (C1-C5) **LOWER UNITS** (L1-L12) **RECEPTION/TRANSACTION COUNTER / CARE TEAM STATION DESK** (TC1-TC2) **UTILITY SINK AND COUNTER UNIT** (UC1)

Category	Min. Length (mm)	Motorized Adjustable Height	Standing Height	Specialty Casework
3	1500	<input type="checkbox"/>	<input type="checkbox"/>	<input type="checkbox"/>

**FINISHES**

Full-height Cabinet:

Upper Millwork:

Countertop:

Lower Millwork:

Shelf:

Remarks: Refer to Schedule 1, Section 6.13 (Division 13) for shielded chamber requirements

## MECHANICAL REQUIREMENTS

<b>PLUMBING</b> (Quantity) Hand Hygiene Sink: <input type="text"/> Lavatory: <input type="text"/> Kitchen Sink: <input type="text"/> Seamless Kitchen Sink: <input type="text"/> Utility / Process Sink: <input type="text"/> Scrub Sink: <input type="text"/> Floor Sink: <input type="text"/> Plumbing Remarks: <input type="text"/>							Other Fixtures: <input type="checkbox"/> Shower <input type="checkbox"/> Eyewash Station <input type="checkbox"/> Tub <input type="checkbox"/> Eyewash/Shower Station <input type="checkbox"/> Ice Maker <input type="checkbox"/> Emergency Shower <input type="checkbox"/> Water Closet <input type="checkbox"/> Flush Rim Sink <input type="checkbox"/> Instantaneous Hot Water <input type="checkbox"/> Floor Drain <input type="checkbox"/> Water Bottle Refill Station Other: <input type="text"/>				<b>MED / NON-MED GASES</b> (Quantity) Oxygen: <input type="text"/> Medical Air: <input type="text"/> Medical Vacuum: <input type="text"/> Nitrous Oxide: <input type="text"/> CO2: <input type="text"/> AGSS: <input type="text"/> Nitrogen: <input type="text"/> Laboratory Air: <input type="text"/> Laboratory Vacuum: <input type="text"/> Utility Compressed Air: <input type="text"/> Gas Remarks: <input type="text"/>					
--	--	--	--	--	--	--	--	--	--	--	--	--	--	--	--	--

**Appendix 1B Minimum Room Requirements**

Room Name:

Program Number(s):

1.	M1.29	7.		13.		19.		25.		31.		37.		43.
2.		8.		14.		20.		26.		32.		38.		44.
3.		9.		15.		21.		27.		33.		39.		45.
4.		10.		16.		22.		28.		34.		40.		46.
5.		11.		17.		23.		29.		35.		41.		47.
6.		12.		18.		24.		30.		36.		42.		48.

**ARCHITECTURAL REQUIREMENTS**

<b>WALL AND CEILING</b> Wall Material: <input type="text" value="ARGB 1.2m AFF, GB above"/> Finish: <input type="text" value="EWC"/> Ceiling Material: <input type="text" value="GB"/> Finish: <input type="text" value="ECC"/>		<b>WALL PROTECTION</b> Type: <input type="text" value="ESRP"/> <input checked="" type="checkbox"/> Corner Guards <input type="checkbox"/> Hand Rails <input type="checkbox"/> Bed Bumper / Locator Height: <input type="text" value="1350 mm"/> <input type="checkbox"/> Crash Rails <input type="checkbox"/> Chair Rail		<b>GLAZING</b> <input type="checkbox"/> Interior Glazing		<b>FLOORING TYPES</b> Material: <input type="text" value="EFC"/> Base: <input type="text" value="FCB"/>		<b>ROOM ACCESSORIES</b> <input type="checkbox"/> Coat Hooks <input type="checkbox"/> Ceiling Lift <input type="checkbox"/> Magnetic Whiteboard <input type="checkbox"/> Mirror <input type="checkbox"/> Infant Change Table <input type="checkbox"/> Privacy Curtain		
---	--	--	--	---	--	--	--	--	--	--

- LEGEND:**
- WALL AND CEILING LEGEND:**
- AC Architectural Ceiling
  - ACT Acoustic Ceiling Tile
  - ACT-C Cleanroom
  - ARGB Abuse-Resistant Gypsum Board
  - GB Gypsum Board
  - IRGB Impact-Resistant Gypsum Board
  - KLCT Kitchen Lay-in Ceiling Tile
  - MMRGB Moisture and Mould-Resistant Gypsum Board
  - SACT Security Acoustic Ceiling Tile
- WALL FINISHES LEGEND:**
- EWC Epoxy Wall Coating
  - HPC High Performance Coating
  - PT Paint
- CEILING FINISHES LEGEND:**
- ECC Epoxy Ceiling Coating
  - HPC High Performance Coating
  - PF Prefinished
  - PT Paint
- WALL PROTECTION LEGEND:**
- ESRP Extruded Semi-Rigid PVCu Panel
  - FRL Fibre Reinforced Laminate
  - FRP Fibreglass Reinforced Plastic
  - PVV Protective Vinyl Wallcovering
  - RHIS Rigid High Impact Sheet
  - WSSP Wetwall Solid Surface Panel
  - WVV Wetroom Vinyl Wallcovering
- FLOOR FINISHES LEGEND:**
- CFS Concrete Floor Sealer
  - EFC Epoxy Floor Coating
  - PFC Polyurethane Floor Coating
  - RAF Rubber Athletic Flooring
  - RSF Rubber Sheet Flooring
  - SCF Seamless Cushioned Flooring
  - SDRF Static-Dissipative Rubber Sheet Flooring
  - SDVF Static-Dissipative Vinyl Sheet Flooring
  - VSF Vinyl Sheet Flooring
  - WSVF Wetroom Safety Vinyl Sheet Flooring
- FLOOR BASE LEGEND:**
- FCB Flash Cove Base
  - RB Rubber Base
  - SCF Seamless Cushioned Flooring

**DOORS**

Types:

Type	Qty	Size (mm)	Material	Finish	Side Lt.	Blinds	Protect.	Privacy Film	Function	Card Reader	Mag Lock	Auto Opener	Hold Open	Hinges	Accessory 1	Accessory 2	Accessory 3	Closer
A	1	1220 x 2135	Hollow Metal	FRL	<input type="checkbox"/>	<input type="checkbox"/>	2 High	<input type="checkbox"/>	Storeroom	<input checked="" type="checkbox"/>	<input type="checkbox"/>	<input type="checkbox"/>	<input checked="" type="checkbox"/>	Cont. Swing Clear				Surface

Door Remarks:  Security Grille  Anti-barricade strategy

**MILLWORK AND SPECIALTY CASEWORK**

Storage Requirements:

**UPPER UNITS** (U1-U8)

**LOWER UNITS** (L1-L12)

**RECEPTION/TRANSACTION COUNTER / CARE TEAM STATION DESK** (TC1, TC2)

**UTILITY SINK AND COUNTER UNIT** (UC1)

**SHELF** (S1)

**FULL-HEIGHT CABINETS** (C1-C5)

**Legend:**

Category	Min. Length (mm)	Motorized Adjustable Height	Standing Height	Specialty Casework
Category 0 - None		<input type="checkbox"/>	<input type="checkbox"/>	<input type="checkbox"/>
Category 1 - Low (1% - 4%)		<input type="checkbox"/>	<input type="checkbox"/>	<input type="checkbox"/>
Category 2 - Med (5% - 9%)		<input type="checkbox"/>	<input type="checkbox"/>	<input type="checkbox"/>
Category 3 - High (10% or Greater)	3	3000	<input type="checkbox"/>	<input type="checkbox"/>

**FINISHES**

Full-height Cabinet:

Upper Millwork:

Countertop:

Lower Millwork:

Shelf:

Remarks: Refer to Schedule 1, Section 6.13 (Division 13) for shielded chamber requirements

**MECHANICAL REQUIREMENTS**

<b>PLUMBING</b> (Quantity) Hand Hygiene Sink: <input type="text"/> Lavatory: <input type="text"/> Kitchen Sink: <input type="text"/> Seamless Kitchen Sink: <input type="text"/> Utility / Process Sink: <input type="text"/> Scrub Sink: <input type="text"/> Floor Sink: <input type="text"/>							Other Fixtures: <input type="checkbox"/> Shower <input type="checkbox"/> Eyewash Station <input type="checkbox"/> Tub <input type="checkbox"/> Eyewash/Shower Station <input type="checkbox"/> Ice Maker <input type="checkbox"/> Emergency Shower <input type="checkbox"/> Water Closet <input type="checkbox"/> Flush Rim Sink <input type="checkbox"/> Instantaneous Hot Water <input type="checkbox"/> Floor Drain <input type="checkbox"/> Water Bottle Refill Station Other: <input type="text"/>				<b>MED / NON-MED GASES</b> (Quantity) Oxygen: <input type="text"/> Medical Air: <input type="text"/> Medical Vacuum: <input type="text"/> Nitrous Oxide: <input type="text"/> CO2: <input type="text"/> AGSS: <input type="text"/> Nitrogen: <input type="text"/> Laboratory Air: <input type="text"/> Laboratory Vacuum: <input type="text"/> Utility Compressed Air: <input type="text"/>					
Plumbing Remarks: <input type="text"/>							Gas Remarks: <input type="text"/>									

**Appendix 1B Minimum Room Requirements**

Room Name:

Program Number(s):

1.	M1.09	7.		13.		19.		25.		31.		37.		43.
2.		8.		14.		20.		26.		32.		38.		44.
3.		9.		15.		21.		27.		33.		39.		45.
4.		10.		16.		22.		28.		34.		40.		46.
5.		11.		17.		23.		29.		35.		41.		47.
6.		12.		18.		24.		30.		36.		42.		48.

**ARCHITECTURAL REQUIREMENTS**

<b>WALL AND CEILING</b> Wall Material: <input type="text" value="ARGB 1.2m AFF, GB above"/> Finish: <input type="text" value="PT"/> Ceiling Material: <input type="text" value="ACT"/> Finish: <input type="text" value="PF"/>		<b>WALL PROTECTION</b> Type: <input type="text" value="ESRP"/> <input checked="" type="checkbox"/> Corner Guards <input type="checkbox"/> Hand Rails <input type="checkbox"/> Bed Bumper / Locator Height: <input type="text" value="1600 mm"/> <input type="checkbox"/> Crash Rails <input type="checkbox"/> Chair Rail			<b>GLAZING</b> <input type="checkbox"/> Interior Glazing		<b>FLOORING TYPES</b> Material: <input type="text" value="VSF"/> Base: <input type="text" value="FCB"/>		<b>ROOM ACCESSORIES</b> <input type="checkbox"/> Coat Hooks <input type="checkbox"/> Ceiling Lift <input type="checkbox"/> Magnetic Whiteboard <input type="checkbox"/> Mirror <input type="checkbox"/> Infant Change Table <input type="checkbox"/> Privacy Curtain		
--	--	--	--	--	---	--	--	--	--	--	--

- LEGEND:**
- WALL AND CEILING LEGEND:**
- AC Architectural Ceiling
  - ACT Acoustic Ceiling Tile
  - ACT-C Cleanroom
  - ARGB Abuse-Resistant Gypsum Board
  - GB Gypsum Board
  - IRGB Impact-Resistant Gypsum Board
  - KLCT Kitchen Lay-in Ceiling Tile
  - MMRGB Moisture and Mould-Resistant Gypsum Board
  - SACT Security Acoustic Ceiling Tile
- WALL FINISHES LEGEND:**
- EWC Epoxy Wall Coating
  - HPC High Performance Coating
  - PT Paint
- CEILING FINISHES LEGEND:**
- ECC Epoxy Ceiling Coating
  - HPC High Performance Coating
  - PF Prefinished
  - PT Paint
- WALL PROTECTION LEGEND:**
- ESRP Extruded Semi-Rigid PVCu Panel
  - FRL Fibre Reinforced Laminat
  - FRP Fibreglass Reinforced Plastic
  - PVV Protective Vinyl Wallcovering
  - RHIS Rigid High Impact Sheet
  - WSSP Wetwall Solid Surface Panel
  - WVV Wetroom Vinyl Wallcovering
- FLOOR FINISHES LEGEND:**
- CFS Concrete Floor Sealer
  - EFC Epoxy Floor Coating
  - PFC Polyurethane Floor Coating
  - RAF Rubber Athletic Flooring
  - RSF Rubber Sheet Flooring
  - SCF Seamless Cushioned Flooring
  - SDRF Static-Dissipative Rubber Sheet Flooring
  - SDVF Static-Dissipative Vinyl Sheet Flooring
  - VSF Vinyl Sheet Flooring
  - WSVF Wetroom Safety Vinyl Sheet Flooring
- FLOOR BASE LEGEND:**
- FCB Flash Cove Base
  - RB Rubber Base
  - SCF Seamless Cushioned Flooring

**DOORS**

Types:

Type	Qty	Size (mm)	Material	Finish	Side Lt.	Blinds	Protect.	Privacy Film	Function	Card Reader	Mag Lock	Auto Opener	Hold Open	Hinges	Accessory 1	Accessory 2	Accessory 3	Closer
C	1	1220 x 2135	Solid Core	FRL	<input type="checkbox"/>	<input type="checkbox"/>	2 High	<input checked="" type="checkbox"/>	Storeroom	<input checked="" type="checkbox"/>	<input type="checkbox"/>	<input type="checkbox"/>	<input checked="" type="checkbox"/>	Cont. Swing Clear				Surface

Door Remarks:  Security Grille  Anti-barricade strategy

**MILLWORK AND SPECIALTY CASEWORK**

Storage Requirements:

**UPPER UNITS** (U1-U8) **SHELF** (S1)

**FULL-HEIGHT CABINETS** (C1-C5) **LOWER UNITS** (L1-L12) **RECEPTION/TRANSACTION COUNTER / CARE TEAM STATION DESK** (TC1-TC2) **UTILITY SINK AND COUNTER UNIT** (UC1)

Category	Min. Length (mm)	Motorized Adjustable Height	Standing Height	Specialty Casework
3	2400	<input type="checkbox"/>	<input type="checkbox"/>	<input type="checkbox"/>

**FINISHES**

Full-height Cabinet:

Upper Millwork:

Countertop:

Lower Millwork:

Shelf:

Remarks:

**MECHANICAL REQUIREMENTS**

<b>PLUMBING</b> (Quantity) Hand Hygiene Sink: <input type="text"/> Lavatory: <input type="text"/> Kitchen Sink: <input type="text"/> Seamless Kitchen Sink: <input type="text"/> Utility / Process Sink: <input type="text"/> Scrub Sink: <input type="text"/> Floor Sink: <input type="text"/>							Other Fixtures: <input type="checkbox"/> Shower <input type="checkbox"/> Tub <input type="checkbox"/> Ice Maker <input type="checkbox"/> Water Closet <input type="checkbox"/> Instantaneous Hot Water			<input type="checkbox"/> Eyewash Station <input type="checkbox"/> Eyewash/Shower Station <input type="checkbox"/> Emergency Shower <input type="checkbox"/> Flush Rim Sink <input type="checkbox"/> Floor Drain <input type="checkbox"/> Water Bottle Refill Station			<b>MED / NON-MED GASES</b> (Quantity) Oxygen: <input type="text"/> Medical Air: <input type="text"/> Medical Vacuum: <input type="text"/> Nitrous Oxide: <input type="text"/> CO2: <input type="text"/> AGSS: <input type="text"/> Nitrogen: <input type="text"/> Laboratory Air: <input type="text"/> Laboratory Vacuum: <input type="text"/> Utility Compressed Air: <input type="text"/>				
Plumbing Remarks: <input type="text"/>							Other: <input type="text"/>			Gas Remarks: <input type="text"/>							



**Appendix 1B Minimum Room Requirements**

Room Name:

Program Number(s):

1. M1.19	7.	13.	19.	25.	31.	37.	43.
2.	8.	14.	20.	26.	32.	38.	44.
3.	9.	15.	21.	27.	33.	39.	45.
4.	10.	16.	22.	28.	34.	40.	46.
5.	11.	17.	23.	29.	35.	41.	47.
6.	12.	18.	24.	30.	36.	42.	48.

**ARCHITECTURAL REQUIREMENTS**

<b>WALL AND CEILING</b> Wall Material: <input type="text" value="ARGB 1.2m AFF, GB above"/> Finish: <input type="text" value="PT"/> Ceiling Material: <input type="text" value="ACT"/> Finish: <input type="text" value="PF"/>	<b>WALL PROTECTION</b> Type: <input type="text" value="ESRP"/> <input checked="" type="checkbox"/> Corner Guards <input type="checkbox"/> Hand Rails <input type="checkbox"/> Bed Bumper / Locator Height: <input type="text" value="2185 mm"/> <input type="checkbox"/> Crash Rails <input type="checkbox"/> Chair Rail	<b>GLAZING</b> <input type="checkbox"/> Interior Glazing	<b>FLOORING TYPES</b> Material: <input type="text" value="VSF"/> Base: <input type="text" value="FCB"/>	<b>ROOM ACCESSORIES</b> <input type="checkbox"/> Coat Hooks <input type="checkbox"/> Ceiling Lift <input type="checkbox"/> Magnetic Whiteboard <input type="checkbox"/> Mirror <input type="checkbox"/> Infant Change Table <input type="checkbox"/> Privacy Curtain
--	--	---	--	--

- LEGEND:**
- WALL AND CEILING LEGEND:**
- AC Architectural Ceiling
  - ACT Acoustic Ceiling Tile
  - ACT-C Cleanroom
  - ARGB Abuse-Resistant Gypsum Board
  - GB Gypsum Board
  - IRGB Impact-Resistant Gypsum Board
  - KLCT Kitchen Lay-in Ceiling Tile
  - MMRGB Moisture and Mould-Resistant Gypsum Board
  - SACT Security Acoustic Ceiling Tile
- WALL FINISHES LEGEND:**
- EWC Epoxy Wall Coating
  - HPC High Performance Coating
  - PT Paint
- CEILING FINISHES LEGEND:**
- ECC Epoxy Ceiling Coating
  - HPC High Performance Coating
  - PF Prefinished
  - PT Paint
- WALL PROTECTION LEGEND:**
- ESRP Extruded Semi-Rigid PVCu Panel
  - FRL Fibre Reinforced Laminated
  - FRP Fibreglass Reinforced Plastic
  - PVV Protective Vinyl Wallcovering
  - RHIS Rigid High Impact Sheet
  - WSSP Wetwall Solid Surface Panel
  - WVV Wetroom Vinyl Wallcovering
- FLOOR FINISHES LEGEND:**
- CFS Concrete Floor Sealer
  - EFC Epoxy Floor Coating
  - PFC Polyurethane Floor Coating
  - RAF Rubber Athletic Flooring
  - RSF Rubber Sheet Flooring
  - SCF Seamless Cushioned Flooring
  - SDRF Static-Dissipative Rubber Sheet Flooring
  - SDVF Static-Dissipative Vinyl Sheet Flooring
  - VSF Vinyl Sheet Flooring
  - WSVF Wetroom Safety Vinyl Sheet Flooring
- FLOOR BASE LEGEND:**
- FCB Flash Cove Base
  - RB Rubber Base
  - SCF Seamless Cushioned Flooring

**DOORS**

Types:

Type	Qty	Size (mm)	Material	Finish	Side Lt.	Blinds	Protect.	Privacy Film	Function	Card Reader	Mag Lock	Auto Opener	Hold Open	Hinges	Accessory 1	Accessory 2	Accessory 3	Closer
A	1	1065 x 2135	Solid Core	FRL	<input type="checkbox"/>	<input type="checkbox"/>	2 High	<input type="checkbox"/>	Storeroom	<input checked="" type="checkbox"/>	<input type="checkbox"/>	<input type="checkbox"/>	<input checked="" type="checkbox"/>	Cont. Swing Clear				Surface
C	1	1065 x 2135	Hollow Metal	Prefinished	<input type="checkbox"/>	<input type="checkbox"/>	2 High	<input type="checkbox"/>	Storeroom	<input checked="" type="checkbox"/>	<input type="checkbox"/>	<input type="checkbox"/>	<input checked="" type="checkbox"/>	Butt Hinge				Surface

Door Remarks:  Security Grille  Anti-barricade strategy

**MILLWORK AND SPECIALTY CASEWORK**

Storage Requirements:

**UPPER UNITS** (U1-U8) **SHELF** (S1)

**FULL-HEIGHT CABINETS** (C1-C5) **LOWER UNITS** (L1-L12) **RECEPTION/TRANSACTION COUNTER / CARE TEAM STATION DESK** (TC1-TC2) **UTILITY SINK AND COUNTER UNIT** (UC1)

Category	Min. Length (mm)	Motorized Adjustable Height	Standing Height	Specialty Casework
Category 0 - None		<input type="checkbox"/>	<input type="checkbox"/>	<input type="checkbox"/>
Category 1 - Low (1% - 4%)		<input type="checkbox"/>	<input type="checkbox"/>	<input type="checkbox"/>
Category 2 - Med (5% - 9%)		<input type="checkbox"/>	<input type="checkbox"/>	<input type="checkbox"/>
Category 3 - High (10% or Greater)		<input type="checkbox"/>	<input type="checkbox"/>	<input type="checkbox"/>

**FINISHES**

Full-height Cabinet:   
 Upper Millwork:   
 Countertop:   
 Lower Millwork:   
 Shelf:

Remarks: Refer to Schedule 1, Section 6.11 (Division 11) for Medical Gas Racks.

**MECHANICAL REQUIREMENTS**

<b>PLUMBING</b> (Quantity) Hand Hygiene Sink: <input type="text"/> Lavatory: <input type="text"/> Kitchen Sink: <input type="text"/> Seamless Kitchen Sink: <input type="text"/> Utility / Process Sink: <input type="text"/> Scrub Sink: <input type="text"/> Floor Sink: <input type="text"/> Plumbing Remarks: <input type="text"/>	Other Fixtures: <input type="checkbox"/> Shower <input type="checkbox"/> Eyewash Station <input type="checkbox"/> Tub <input type="checkbox"/> Eyewash/Shower Station <input type="checkbox"/> Ice Maker <input type="checkbox"/> Emergency Shower <input type="checkbox"/> Water Closet <input type="checkbox"/> Flush Rim Sink <input type="checkbox"/> Instantaneous Hot Water <input type="checkbox"/> Floor Drain <input type="checkbox"/> <input type="checkbox"/> Water Bottle Refill Station Other: <input type="text"/>	<b>MED / NON-MED GASES</b> (Quantity) Oxygen: <input type="text"/> Medical Air: <input type="text"/> Medical Vacuum: <input type="text"/> Nitrous Oxide: <input type="text"/> CO2: <input type="text"/> AGSS: <input type="text"/> Nitrogen: <input type="text"/> Laboratory Air: <input type="text"/> Laboratory Vacuum: <input type="text"/> Utility Compressed Air: <input type="text"/> Gas Remarks: <input type="text"/>
---	---	--

# Appendix 1B Minimum Room Requirements

Room Name:

Program Number(s):

1. M1.32	7.	13.	19.	25.	31.	37.	43.
2.	8.	14.	20.	26.	32.	38.	44.
3.	9.	15.	21.	27.	33.	39.	45.
4.	10.	16.	22.	28.	34.	40.	46.
5.	11.	17.	23.	29.	35.	41.	47.
6.	12.	18.	24.	30.	36.	42.	48.

## ARCHITECTURAL REQUIREMENTS

<b>WALL AND CEILING</b> Wall Material: <input type="text" value="ARGB 1.2m AFF, GB above"/> Finish: <input type="text" value="EWC"/> Ceiling Material: <input type="text" value="GB"/> Finish: <input type="text" value="ECC"/>	<b>WALL PROTECTION</b> Type: <input type="text" value="ESRP"/> <input checked="" type="checkbox"/> Corner Guards <input type="checkbox"/> Hand Rails <input type="checkbox"/> Bed Bumper / Locator Height: <input type="text" value="1350 mm"/> <input type="checkbox"/> Crash Rails <input type="checkbox"/> Chair Rail	<b>GLAZING</b> <input type="checkbox"/> Interior Glazing	<b>FLOORING TYPES</b> Material: <input type="text" value="EFC"/> Base: <input type="text" value="FCB"/>	<b>ROOM ACCESSORIES</b> <input type="checkbox"/> Coat Hooks <input type="checkbox"/> Ceiling Lift <input type="checkbox"/> Magnetic Whiteboard <input type="checkbox"/> Mirror <input type="checkbox"/> Infant Change Table <input type="checkbox"/> Privacy Curtain
---	--	---	--	--

- LEGEND:**
- WALL AND CEILING LEGEND:**
- AC Architectural Ceiling
  - ACT Acoustic Ceiling Tile
  - ACT-C Cleanroom
  - ARGB Abuse-Resistant Gypsum Board
  - GB Gypsum Board
  - IRGB Impact-Resistant Gypsum Board
  - KLCT Kitchen Lay-in Ceiling Tile
  - MMRGB Moisture and Mould-Resistant Gypsum Board
  - SACT Security Acoustic Ceiling Tile
- WALL FINISHES LEGEND:**
- EWC Epoxy Wall Coating
  - HPC High Performance Coating
  - PT Paint
- CEILING FINISHES LEGEND:**
- ECC Epoxy Ceiling Coating
  - HPC High Performance Coating
  - PF Prefinished
  - PT Paint
- WALL PROTECTION LEGEND:**
- ESRP Extruded Semi-Rigid PVCu Panel
  - FRL Fibre Reinforced Laminated
  - FRP Fibreglass Reinforced Plastic
  - PVV Protective Vinyl Wallcovering
  - RHIS Rigid High Impact Sheet
  - WSSP Wetwall Solid Surface Panel
  - WVV Wetroom Vinyl Wallcovering
- FLOOR FINISHES LEGEND:**
- CFS Concrete Floor Sealer
  - EFC Epoxy Floor Coating
  - PFC Polyurethane Floor Coating
  - RAF Rubber Athletic Flooring
  - RSF Rubber Sheet Flooring
  - SCF Seamless Cushioned Flooring
  - SDRF Static-Dissipative Rubber Sheet Flooring
  - SDVF Static-Dissipative Vinyl Sheet Flooring
  - VSF Vinyl Sheet Flooring
  - WSVF Wetroom Safety Vinyl Sheet Flooring
- FLOOR BASE LEGEND:**
- FCB Flash Cove Base
  - RB Rubber Base
  - SCF Seamless Cushioned Flooring

**DOORS**

Types:

Type	Qty	Size (mm)	Material	Finish	Side Lt.	Blinds	Protect.	Privacy Film	Function	Card Reader	Mag Lock	Auto Opener	Hold Open	Hinges	Accessory 1	Accessory 2	Accessory 3	Closer
C	1	1065 x 2135	Solid Core	FRL	<input type="checkbox"/>	<input type="checkbox"/>		<input type="checkbox"/>	Storeroom	<input checked="" type="checkbox"/>	<input type="checkbox"/>	<input type="checkbox"/>	<input type="checkbox"/>	Cont. Swing Clear				Surface

Door Remarks:  Security Grille  Anti-barricade strategy

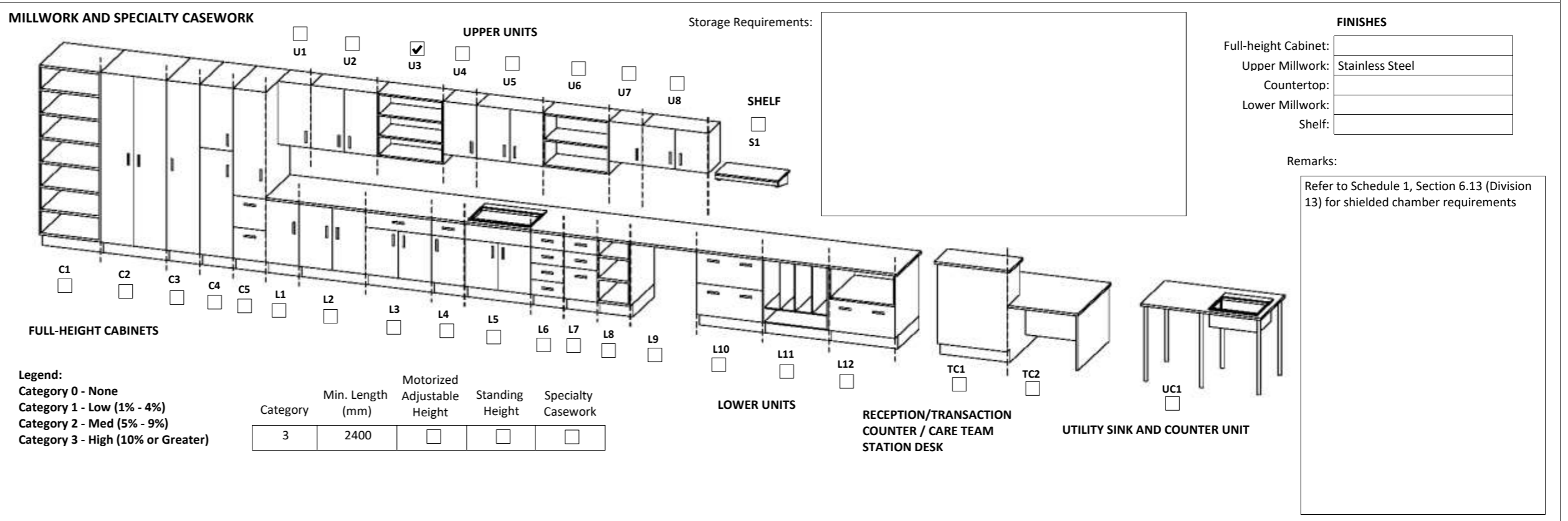

## MECHANICAL REQUIREMENTS

<b>PLUMBING</b> (Quantity) Hand Hygiene Sink: <input type="text"/> Lavatory: <input type="text"/> Kitchen Sink: <input type="text"/> Seamless Kitchen Sink: <input type="text"/> Utility / Process Sink: <input type="text"/> Scrub Sink: <input type="text"/> Floor Sink: <input type="text"/> Plumbing Remarks: <input type="text"/>	Other Fixtures: <input type="checkbox"/> Shower <input type="checkbox"/> Eyewash Station <input type="checkbox"/> Tub <input type="checkbox"/> Eyewash/Shower Station <input type="checkbox"/> Ice Maker <input type="checkbox"/> Emergency Shower <input type="checkbox"/> Water Closet <input type="checkbox"/> Flush Rim Sink <input type="checkbox"/> Instantaneous Hot Water <input type="checkbox"/> Floor Drain <input type="checkbox"/> <input type="checkbox"/> Water Bottle Refill Station Other: <input type="text"/>	<b>MED / NON-MED GASES</b> (Quantity) Oxygen: <input type="text"/> Medical Air: <input type="text"/> Medical Vacuum: <input type="text"/> Nitrous Oxide: <input type="text"/> CO2: <input type="text"/> AGSS: <input type="text"/> Nitrogen: <input type="text"/> Laboratory Air: <input type="text"/> Laboratory Vacuum: <input type="text"/> Utility Compressed Air: <input type="text" value="2"/> Gas Remarks: <input type="text"/>
---	---	---

# Appendix 1B Minimum Room Requirements

Room Name:

Program Number(s):

1. M1.39	7.	13.	19.	25.	31.	37.	43.
2.	8.	14.	20.	26.	32.	38.	44.
3.	9.	15.	21.	27.	33.	39.	45.
4.	10.	16.	22.	28.	34.	40.	46.
5.	11.	17.	23.	29.	35.	41.	47.
6.	12.	18.	24.	30.	36.	42.	48.

## ARCHITECTURAL REQUIREMENTS

<b>WALL AND CEILING</b> Wall Material: <input type="text" value="Concrete"/> Finish: <input type="text" value="EWC"/> Ceiling Material: <input type="text"/> Finish: <input type="text"/>	<b>WALL PROTECTION</b> Type: <input type="text"/> Height: <input type="text"/> <input type="checkbox"/> Corner Guards <input type="checkbox"/> Hand Rails <input type="checkbox"/> Bed Bumper / Locator <input type="checkbox"/> Crash Rails <input type="checkbox"/> Chair Rail	<b>GLAZING</b> <input type="checkbox"/> Interior Glazing	<b>FLOORING TYPES</b> Material: <input type="text" value="EFC"/> Base: <input type="text" value="FCB"/>	<b>ROOM ACCESSORIES</b> <input type="checkbox"/> Coat Hooks <input type="checkbox"/> Ceiling Lift <input type="checkbox"/> Magnetic Whiteboard <input type="checkbox"/> Mirror <input type="checkbox"/> Infant Change Table <input type="checkbox"/> Privacy Curtain
---	---	---	--	--

- LEGEND:**
- WALL AND CEILING LEGEND:**
- AC Architectural Ceiling
  - ACT Acoustic Ceiling Tile
  - ACT-C Cleanroom
  - ARGB Abuse-Resistant Gypsum Board
  - GB Gypsum Board
  - IRGB Impact-Resistant Gypsum Board
  - KLCT Kitchen Lay-in Ceiling Tile
  - MMRGB Moisture and Mould-Resistant Gypsum Board
  - SACT Security Acoustic Ceiling Tile
- WALL FINISHES LEGEND:**
- EWC Epoxy Wall Coating
  - HPC High Performance Coating
  - PT Paint
- CEILING FINISHES LEGEND:**
- ECC Epoxy Ceiling Coating
  - HPC High Performance Coating
  - PF Prefinished
  - PT Paint
- WALL PROTECTION LEGEND:**
- ESRP Extruded Semi-Rigid PVCu Panel
  - FRL Fibre Reinforced Laminate
  - FRP Fibreglass Reinforced Plastic
  - PVV Protective Vinyl Wallcovering
  - RHIS Rigid High Impact Sheet
  - WSSP Wetwall Solid Surface Panel
  - WWW Wetroom Vinyl Wallcovering
- FLOOR FINISHES LEGEND:**
- CFS Concrete Floor Sealer
  - EFC Epoxy Floor Coating
  - PFC Polyurethane Floor Coating
  - RAF Rubber Athletic Flooring
  - RSF Rubber Sheet Flooring
  - SCF Seamless Cushioned Flooring
  - SDRF Static-Dissipative Rubber Sheet Flooring
  - SDVF Static-Dissipative Vinyl Sheet Flooring
  - VSF Vinyl Sheet Flooring
  - WSVF Wetroom Safety Vinyl Sheet Flooring
- FLOOR BASE LEGEND:**
- FCB Flash Cove Base
  - RB Rubber Base
  - SCF Seamless Cushioned Flooring

**DOORS**

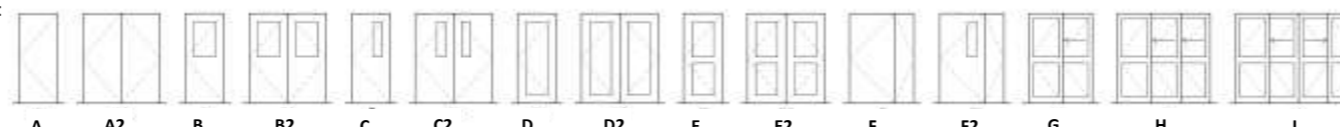
Types: 

Note: for Type F doors, the door panels will be approximately 465/1065 unless otherwise required by the Authority

Type:Qty:	Size (mm):	Material:	Finish:	Side Lt:	Blinds:	Protect.:	Privacy Film:	Function:	Card Reader:	Mag Lock:	Auto Opener:	Hold Open:	Hinges:	Accessory 1:	Accessory 2:	Accessory 3:	Closer:
F2 2	1530 x 2135	Hollow Metal	FRL	<input type="checkbox"/>	<input type="checkbox"/>		<input type="checkbox"/>	Storeroom	<input checked="" type="checkbox"/>	<input type="checkbox"/>	<input type="checkbox"/>	<input checked="" type="checkbox"/>	Butt Hinge	Astragal	Flush Bolt		Surface

Door Remarks:  Security Grille  Anti-barricade strategy

**MILLWORK AND SPECIALTY CASEWORK**

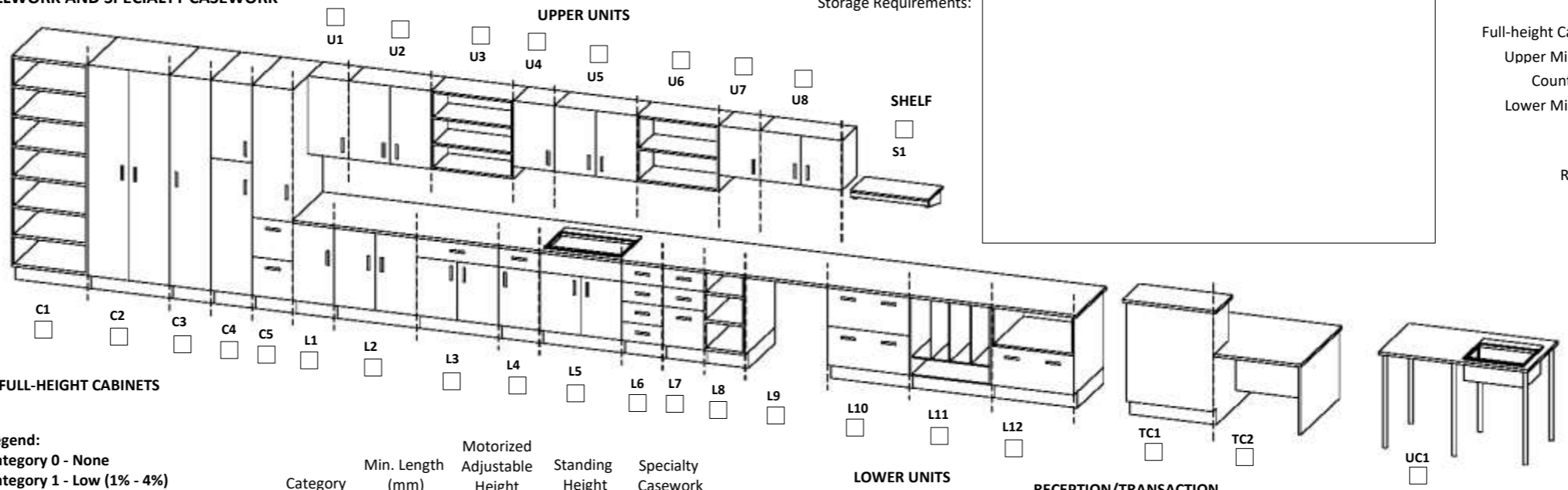

**UPPER UNITS** (U1-U8) **LOWER UNITS** (L1-L12) **RECEPTION/TRANSACTION COUNTER / CARE TEAM STATION DESK** (TC1-TC2) **UTILITY SINK AND COUNTER UNIT** (UC1)

Storage Requirements:

**FINISHES**

Full-height Cabinet:   
 Upper Millwork:   
 Countertop:   
 Lower Millwork:   
 Shelf:

Remarks: Refer to Schedule 1, Section 6.11 (Division 11) for Medical Gas Racks. M1.39 Technical Area will provide access to the top of the hot cells located in M1.26 Clean Room and M1.27 Small Clean Room. Provide maintenance walkways for access to services.

## MECHANICAL REQUIREMENTS

<b>PLUMBING</b> (Quantity) Hand Hygiene Sink: <input type="text"/> Lavatory: <input type="text"/> Kitchen Sink: <input type="text"/> Seamless Kitchen Sink: <input type="text"/> Utility / Process Sink: <input type="text"/> Scrub Sink: <input type="text"/> Floor Sink: <input type="text"/> Plumbing Remarks: <input type="text"/>	Other Fixtures: <input type="checkbox"/> Shower <input type="checkbox"/> Tub <input type="checkbox"/> Ice Maker <input type="checkbox"/> Water Closet <input type="checkbox"/> Instantaneous Hot Water <input type="checkbox"/> Eyewash Station <input type="checkbox"/> Eyewash/Shower Station <input type="checkbox"/> Emergency Shower <input type="checkbox"/> Flush Rim Sink <input type="checkbox"/> Floor Drain <input type="checkbox"/> Water Bottle Refill Station Other: <input type="text"/>	<b>MED / NON-MED GASES</b> (Quantity) Oxygen: <input type="text"/> Medical Air: <input type="text"/> Medical Vacuum: <input type="text"/> Nitrous Oxide: <input type="text"/> CO2: <input type="text"/> AGSS: <input type="text"/> Nitrogen: <input type="text"/> Laboratory Air: <input type="text"/> Laboratory Vacuum: <input type="text"/> Utility Compressed Air: <input type="text"/> Gas Remarks: <input type="text"/>
--	--	---



**Appendix 1B Minimum Room Requirements**

Room Name:

Program Number(s):

1. M1.17	7.	13.	19.	25.	31.	37.	43.
2.	8.	14.	20.	26.	32.	38.	44.
3.	9.	15.	21.	27.	33.	39.	45.
4.	10.	16.	22.	28.	34.	40.	46.
5.	11.	17.	23.	29.	35.	41.	47.
6.	12.	18.	24.	30.	36.	42.	48.

**ARCHITECTURAL REQUIREMENTS**

<b>WALL AND CEILING</b> Wall Material: <input type="text" value="MMRGB"/> Finish: <input type="text" value="EWC"/> Ceiling Material: <input type="text" value="ACT"/> Finish: <input type="text" value="PF"/>	<b>WALL PROTECTION</b> Type: <input type="text" value="RHIS"/> <input checked="" type="checkbox"/> Corner Guards <input type="checkbox"/> Hand Rails <input type="checkbox"/> Bed Bumper / Locator Height: <input type="text" value="1350 mm"/> <input checked="" type="checkbox"/> Crash Rails <input type="checkbox"/> Chair Rail	<b>GLAZING</b> <input checked="" type="checkbox"/> Interior Glazing	<b>FLOORING TYPES</b> Material: <input type="text" value="VSF"/> Base: <input type="text" value="FCB"/>	<b>ROOM ACCESSORIES</b> <input type="checkbox"/> Coat Hooks <input type="checkbox"/> Ceiling Lift <input type="checkbox"/> Magnetic Whiteboard <input type="checkbox"/> Mirror <input type="checkbox"/> Infant Change Table <input type="checkbox"/> Privacy Curtain
---	---	--	--	--

- LEGEND:**
- WALL AND CEILING LEGEND:**
- AC Architectural Ceiling
  - ACT Acoustic Ceiling Tile
  - ACT-C Cleanroom
  - ARGB Abuse-Resistant Gypsum Board
  - GB Gypsum Board
  - IRGB Impact-Resistant Gypsum Board
  - KLCT Kitchen Lay-in Ceiling Tile
  - MMRGB Moisture and Mould-Resistant Gypsum Board
  - SACT Security Acoustic Ceiling Tile
- WALL FINISHES LEGEND:**
- EWC Epoxy Wall Coating
  - HPC High Performance Coating
  - PT Paint
- CEILING FINISHES LEGEND:**
- ECC Epoxy Ceiling Coating
  - HPC High Performance Coating
  - PF Prefinished
  - PT Paint
- WALL PROTECTION LEGEND:**
- ESRP Extruded Semi-Rigid PVCu Panel
  - FRL Fibre Reinforced Laminate
  - FRP Fibreglass Reinforced Plastic
  - PVV Protective Vinyl Wallcovering
  - RHIS Rigid High Impact Sheet
  - WSSP Wetwall Solid Surface Panel
  - WVV Wetroom Vinyl Wallcovering
- FLOOR FINISHES LEGEND:**
- CFS Concrete Floor Sealer
  - EFC Epoxy Floor Coating
  - PFC Polyurethane Floor Coating
  - RAF Rubber Athletic Flooring
  - RSF Rubber Sheet Flooring
  - SCF Seamless Cushioned Flooring
  - SDRF Static-Dissipative Rubber Sheet Flooring
  - SDVF Static-Dissipative Vinyl Sheet Flooring
  - VSF Vinyl Sheet Flooring
  - WSVF Wetroom Safety Vinyl Sheet Flooring
- FLOOR BASE LEGEND:**
- FCB Flash Cove Base
  - RB Rubber Base
  - SCF Seamless Cushioned Flooring

**DOORS**

Types:

Type	Qty	Size (mm)	Material	Finish	Side Lt.	Blinds	Protect.	Privacy Film	Function	Card Reader	Mag Lock	Auto Opener	Hold Open	Hinges	Accessory 1	Accessory 2	Accessory 3	Closer
C	2	1065 x 2135	Solid Core	FRL	<input type="checkbox"/>	<input type="checkbox"/>	2 High	<input checked="" type="checkbox"/>	Storeroom	<input checked="" type="checkbox"/>	<input type="checkbox"/>	<input checked="" type="checkbox"/>	<input checked="" type="checkbox"/>	Butt Hinge	Elec. Strike			Surface

Door Remarks: Provide two-way voice intercommunication and remote release from Shipping/Receiving Room.

Security Grille  
 Anti-barricade strategy



**MECHANICAL REQUIREMENTS**

<b>PLUMBING</b> (Quantity) Hand Hygiene Sink: <input type="text"/> Lavatory: <input type="text"/> Kitchen Sink: <input type="text"/> Seamless Kitchen Sink: <input type="text"/> Utility / Process Sink: <input type="text"/> Scrub Sink: <input type="text"/> Floor Sink: <input type="text"/> Plumbing Remarks: <input type="text"/>	Other Fixtures: <input type="checkbox"/> Shower <input type="checkbox"/> Tub <input type="checkbox"/> Ice Maker <input type="checkbox"/> Water Closet <input type="checkbox"/> Instantaneous Hot Water <input type="checkbox"/> Eyewash Station <input type="checkbox"/> Eyewash/Shower Station <input type="checkbox"/> Emergency Shower <input type="checkbox"/> Flush Rim Sink <input type="checkbox"/> Floor Drain <input type="checkbox"/> Water Bottle Refill Station Other: <input type="text"/>	<b>MED / NON-MED GASES</b> (Quantity) Oxygen: <input type="text"/> Medical Air: <input type="text"/> Medical Vacuum: <input type="text"/> Nitrous Oxide: <input type="text"/> CO2: <input type="text"/> AGSS: <input type="text"/> Nitrogen: <input type="text"/> Laboratory Air: <input type="text"/> Laboratory Vacuum: <input type="text"/> Utility Compressed Air: <input type="text"/> Gas Remarks: <input type="text"/>
---	---	---

**Appendix 1B Minimum Room Requirements**

Room Name:

Program Number(s):

1.	M2.26	7.		13.		19.		25.		31.		37.		43.
2.		8.		14.		20.		26.		32.		38.		44.
3.		9.		15.		21.		27.		33.		39.		45.
4.		10.		16.		22.		28.		34.		40.		46.
5.		11.		17.		23.		29.		35.		41.		47.
6.		12.		18.		24.		30.		36.		42.		48.

**ARCHITECTURAL REQUIREMENTS**

<b>WALL AND CEILING</b> Wall Material: <input type="text" value="MMRGB"/> Finish: <input type="text" value="EWC"/> Ceiling Material: <input type="text" value="MMRGB"/> Finish: <input type="text" value="ECC"/>		<b>WALL PROTECTION</b> Type: <input type="text" value="FRP"/> <input checked="" type="checkbox"/> Corner Guards <input type="checkbox"/> Hand Rails <input type="checkbox"/> Bed Bumper / Locator Height: <input type="text" value="1350 mm"/> <input type="checkbox"/> Crash Rails <input type="checkbox"/> Chair Rail		<b>GLAZING</b> <input type="checkbox"/> Interior Glazing		<b>FLOORING TYPES</b> Material: <input type="text" value="WSVF"/> Base: <input type="text" value="FCB"/>		<b>ROOM ACCESSORIES</b> <input checked="" type="checkbox"/> Coat Hooks <input type="checkbox"/> Ceiling Lift <input type="checkbox"/> Magnetic Whiteboard <input checked="" type="checkbox"/> Mirror <input type="checkbox"/> Infant Change Table <input type="checkbox"/> Privacy Curtain	
--	--	---	--	---	--	---	--	--	--

- LEGEND:**
- WALL AND CEILING LEGEND:**
- AC Architectural Ceiling
  - ACT Acoustic Ceiling Tile
  - ACT-C Cleanroom
  - ARGB Abuse-Resistant Gypsum Board
  - GB Gypsum Board
  - IRGB Impact-Resistant Gypsum Board
  - KLCT Kitchen Lay-in Ceiling Tile
  - MMRGB Moisture and Mould-Resistant Gypsum Board
  - SACT Security Acoustic Ceiling Tile
- WALL FINISHES LEGEND:**
- EWC Epoxy Wall Coating
  - HPC High Performance Coating
  - PT Paint
- CEILING FINISHES LEGEND:**
- ECC Epoxy Ceiling Coating
  - HPC High Performance Coating
  - PF Prefinished
  - PT Paint
- WALL PROTECTION LEGEND:**
- ESRP Extruded Semi-Rigid PVCu Panel
  - FRL Fibre Reinforced Laminate
  - FRP Fibreglass Reinforced Plastic
  - PVV Protective Vinyl Wallcovering
  - RHIS Rigid High Impact Sheet
  - WSSP Wetwall Solid Surface Panel
  - WVV Wetroom Vinyl Wallcovering
- FLOOR FINISHES LEGEND:**
- CFS Concrete Floor Sealer
  - EFC Epoxy Floor Coating
  - PFC Polyurethane Floor Coating
  - RAF Rubber Athletic Flooring
  - RSF Rubber Sheet Flooring
  - SCF Seamless Cushioned Flooring
  - SDRF Static-Dissipative Rubber Sheet Flooring
  - SDVF Static-Dissipative Vinyl Sheet Flooring
  - VSF Vinyl Sheet Flooring
  - WSVF Wetroom Safety Vinyl Sheet Flooring
- FLOOR BASE LEGEND:**
- FCB Flash Cove Base
  - RB Rubber Base
  - SCF Seamless Cushioned Flooring

**DOORS**

Types:

Type	Qty	Size (mm)	Material	Finish	Side Lt.	Blinds	Protect.	Film	Function	Card Reader	Mag Lock	Auto Opener	Hold Open	Hinges	Accessory 1	Accessory 2	Accessory 3	Closer
A	1	1065 x 2135	Solid Core	FRL	<input type="checkbox"/>	<input type="checkbox"/>	1 Low	<input type="checkbox"/>	Privacy	<input type="checkbox"/>	<input type="checkbox"/>	<input type="checkbox"/>	<input type="checkbox"/>	Cont. Double-Acting	Safety Stop			Surface

Door Remarks:  Security Grille  Anti-barricade strategy

**MILLWORK AND SPECIALTY CASEWORK**

**UPPER UNITS** (U1-U8) **LOWER UNITS** (L1-L12) **RECEPTION/TRANSACTION COUNTER / CARE TEAM STATION DESK** (TC1-TC2) **UTILITY SINK AND COUNTER UNIT** (UC1)

Storage Requirements:  SHELF  S1

Category	Min. Length (mm)	Motorized Adjustable Height	Standing Height	Specialty Casework
2	600	<input type="checkbox"/>	<input type="checkbox"/>	<input type="checkbox"/>

**FINISHES**

Full-height Cabinet:   
 Upper Millwork:   
 Countertop:   
 Lower Millwork:   
 Shelf:

Remarks:

**MECHANICAL REQUIREMENTS**

<b>PLUMBING</b> (Quantity) Hygiene Sink: <input type="text"/> Lavatory: <input type="text" value="1"/> Kitchen Sink: <input type="text"/> Kitchen Sink: <input type="text"/> Process Sink: <input type="text"/> Scrub Sink: <input type="text"/> Floor Sink: <input type="text"/>		Other Fixtures: <input type="checkbox"/> Shower <input type="checkbox"/> Tub <input type="checkbox"/> Ice Maker <input checked="" type="checkbox"/> Water Closet <input type="checkbox"/> Instantaneous Hot Water		<input type="checkbox"/> Eyewash Station <input type="checkbox"/> Eyewash/Shower Station <input type="checkbox"/> Emergency Shower <input type="checkbox"/> Flush Rim Sink <input type="checkbox"/> Floor Drain <input type="checkbox"/> Water Bottle Refill Station		<b>MED / NON-MED GASES</b> (Quantity) Oxygen: <input type="text"/> Medical Air: <input type="text"/> Medical Vacuum: <input type="text"/> Nitrous Oxide: <input type="text"/> CO2: <input type="text"/> AGSS: <input type="text"/> Nitrogen: <input type="text"/> Laboratory Air: <input type="text"/> Laboratory Vacuum: <input type="text"/> Utility Compressed Air: <input type="text"/>	
Plumbing Remarks: <input type="text" value="Requires stainless steel fixtures (wall mounted water closet with integral seat)"/>		Gas Remarks: <input type="text"/>					

**Appendix 1B Minimum Room Requirements**

Room Name:

Program Number(s):

1. M1.30	7.	13.	19.	25.	31.	37.	43.
2.	8.	14.	20.	26.	32.	38.	44.
3.	9.	15.	21.	27.	33.	39.	45.
4.	10.	16.	22.	28.	34.	40.	46.
5.	11.	17.	23.	29.	35.	41.	47.
6.	12.	18.	24.	30.	36.	42.	48.

**ARCHITECTURAL REQUIREMENTS**

<b>WALL AND CEILING</b> Wall Material: <input type="text" value="ARGB"/> Finish: <input type="text" value="EWC"/> Ceiling Material: <input type="text" value="GB"/> Finish: <input type="text" value="ECC"/>	<b>WALL PROTECTION</b> Type: <input type="text" value="RHIS"/> <input checked="" type="checkbox"/> Corner Guards <input type="checkbox"/> Hand Rails <input type="checkbox"/> Bed Bumper / Locator Height: <input type="text" value="2480 mm"/> <input type="checkbox"/> Crash Rails <input type="checkbox"/> Chair Rail	<b>GLAZING</b> <input type="checkbox"/> Interior Glazing	<b>FLOORING TYPES</b> Material: <input type="text" value="EFC"/> Base: <input type="text" value="FCB"/>	<b>ROOM ACCESSORIES</b> <input type="checkbox"/> Coat Hooks <input type="checkbox"/> Ceiling Lift <input checked="" type="checkbox"/> Magnetic Whiteboard <input type="checkbox"/> Mirror <input type="checkbox"/> Infant Change Table <input type="checkbox"/> Privacy Curtain
--	--	---	--	---

- LEGEND:**
- WALL AND CEILING LEGEND:**
- AC Architectural Ceiling
  - ACT Acoustic Ceiling Tile
  - ACT-C Cleanroom
  - ARGB Abuse-Resistant Gypsum Board
  - GB Gypsum Board
  - IRGB Impact-Resistant Gypsum Board
  - KLCT Kitchen Lay-in Ceiling Tile
  - MMRGB Moisture and Mould-Resistant Gypsum Board
  - SACT Security Acoustic Ceiling Tile
- WALL FINISHES LEGEND:**
- EWC Epoxy Wall Coating
  - HPC High Performance Coating
  - PT Paint
- CEILING FINISHES LEGEND:**
- ECC Epoxy Ceiling Coating
  - HPC High Performance Coating
  - PF Prefinished
  - PT Paint
- WALL PROTECTION LEGEND:**
- ESRP Extruded Semi-Rigid PVCu Panel
  - FRL Fibre Reinforced Laminate
  - FRP Fibreglass Reinforced Plastic
  - PVV Protective Vinyl Wallcovering
  - RHIS Rigid High Impact Sheet
  - WSSP Wetwall Solid Surface Panel
  - WVV Wetroom Vinyl Wallcovering
- FLOOR FINISHES LEGEND:**
- CFS Concrete Floor Sealer
  - EFC Epoxy Floor Coating
  - PFC Polyurethane Floor Coating
  - RAF Rubber Athletic Flooring
  - RSF Rubber Sheet Flooring
  - SCF Seamless Cushioned Flooring
  - SDRF Static-Dissipative Rubber Sheet Flooring
  - SDVF Static-Dissipative Vinyl Sheet Flooring
  - VSF Vinyl Sheet Flooring
  - WSVF Wetroom Safety Vinyl Sheet Flooring
- FLOOR BASE LEGEND:**
- FCB Flash Cove Base
  - RB Rubber Base
  - SCF Seamless Cushioned Flooring

**DOORS**

Types:

Note: for Type F doors, the door panels will be approximately 465/1065 unless otherwise required by the Authority

Type:Qty:	Size (mm):	Material:	Finish:	Side Lt:	Blinds:	Protect.:	Privacy Film:	Function:	Card Reader:	Mag Lock:	Auto Opener:	Hold Open:	Hinges:	Accessory 1:	Accessory 2:	Accessory 3:	Closer:
F2 2	1530 x 2135	Hollow Metal	Paint	<input type="checkbox"/>	<input type="checkbox"/>		<input type="checkbox"/>	Storeroom	<input checked="" type="checkbox"/>	<input type="checkbox"/>	<input type="checkbox"/>	<input type="checkbox"/>	Butt Hinge	Astragal	Flush Bolt		Surface

**DOOR REMARKS:**

Security Grille  
 Anti-barricade strategy

**MILLWORK AND SPECIALTY CASEWORK**

Storage Requirements:

**UPPER UNITS:** U1, U2, U3, U4, U5, U6, U7, U8

**LOWER UNITS:** L1, L2, L3, L4, L5, L6, L7, L8, L9, L10, L11, L12

**RECEPTION/TRANSACTION COUNTER / CARE TEAM STATION DESK:** TC1, TC2

**UTILITY SINK AND COUNTER UNIT:** UC1

**SHELF:** S1

**FULL-HEIGHT CABINETS:** C1, C2, C3, C4, C5

**Legend:**

Category	Min. Length (mm)	Motorized Adjustable Height	Standing Height	Specialty Casework
3	4500	<input type="checkbox"/>	<input checked="" type="checkbox"/>	<input type="checkbox"/>

**FINISHES**

Full-height Cabinet:   
 Upper Millwork:   
 Countertop:   
 Lower Millwork:   
 Shelf:

**REMARKS:**

**MECHANICAL REQUIREMENTS**

**PLUMBING**

Hand Hygiene Sink:	Lavatory:	Kitchen Sink:	Seamless Kitchen Sink:	Utility / Process Sink:	Scrub Sink:	Floor Sink:
				1		

Plumbing Remarks:

**Other Fixtures:**

- Shower
- Tub
- Ice Maker
- Water Closet
- Instantaneous Hot Water
- Ewewash Station
- Eyewash/Shower Station
- Emergency Shower
- Flush Rim Sink
- Floor Drain
- Water Bottle Refill Station

Other:

**MED / NON-MED GASES**

Oxygen:	Medical Air:	Medical Vacuum:	Nitrous Oxide:	CO2:	AGSS:	Nitrogen:	Laboratory Air:	Laboratory Vacuum:	Utility Compressed Air:
									2

Gas Remarks:



---

# New Surrey Hospital & BC Cancer Centre

MINIMUM ROOM REQUIREMENTS

**N. Interprofessional Team**

---

**Appendix 1B Minimum Room Requirements**

Room Name:

Program Number(s):

1.	N2.01	7.		13.		19.		25.		31.		37.		43.
2.		8.		14.		20.		26.		32.		38.		44.
3.		9.		15.		21.		27.		33.		39.		45.
4.		10.		16.		22.		28.		34.		40.		46.
5.		11.		17.		23.		29.		35.		41.		47.
6.		12.		18.		24.		30.		36.		42.		48.

**ARCHITECTURAL REQUIREMENTS**

<b>WALL AND CEILING</b> Wall Material: <input type="text" value="ARGB 1.2m AFF, GB above"/> Finish: <input type="text" value="PT"/> Ceiling Material: <input type="text" value="ACT"/> Finish: <input type="text" value="PF"/>		<b>WALL PROTECTION</b> Type: <input type="text" value="RHIS"/> <input checked="" type="checkbox"/> Corner Guards <input type="checkbox"/> Hand Rails <input type="checkbox"/> Bed Bumper / Locator Height: <input type="text" value="2185 mm"/> <input type="checkbox"/> Crash Rails <input type="checkbox"/> Chair Rail			<b>GLAZING</b> <input type="checkbox"/> Interior Glazing		<b>FLOORING TYPES</b> Material: <input type="text" value="VSF"/> Base: <input type="text" value="FCB"/>		<b>ROOM ACCESSORIES</b> <input type="checkbox"/> Coat Hooks <input type="checkbox"/> Ceiling Lift <input checked="" type="checkbox"/> Magnetic Whiteboard <input type="checkbox"/> Mirror <input type="checkbox"/> Infant Change Table <input type="checkbox"/> Privacy Curtain		
--	--	--	--	--	---	--	--	--	---	--	--

- LEGEND:**
- WALL AND CEILING LEGEND:**
- AC Architectural Ceiling
  - ACT Acoustic Ceiling Tile
  - ACT-C Cleanroom
  - ARGB Abuse-Resistant Gypsum Board
  - GB Gypsum Board
  - IRGB Impact-Resistant Gypsum Board
  - KLCT Kitchen Lay-in Ceiling Tile
  - MMRGB Moisture and Mould-Resistant Gypsum Board
  - SACT Security Acoustic Ceiling Tile
- WALL FINISHES LEGEND:**
- EWC Epoxy Wall Coating
  - HPC High Performance Coating
  - PT Paint
- CEILING FINISHES LEGEND:**
- ECC Epoxy Ceiling Coating
  - HPC High Performance Coating
  - PF Prefinished
  - PT Paint
- WALL PROTECTION LEGEND:**
- ESRP Extruded Semi-Rigid PVCu Panel
  - FRL Fibre Reinforced Laminate
  - FRP Fibreglass Reinforced Plastic
  - PVV Protective Vinyl Wallcovering
  - RHIS Rigid High Impact Sheet
  - WSSP Wetwall Solid Surface Panel
  - WVV Wetroom Vinyl Wallcovering
- FLOOR FINISHES LEGEND:**
- CFS Concrete Floor Sealer
  - EFC Epoxy Floor Coating
  - PFC Polyurethane Floor Coating
  - RAF Rubber Athletic Flooring
  - RSF Rubber Sheet Flooring
  - SCF Seamless Cushioned Flooring
  - SDRF Static-Dissipative Rubber Sheet Flooring
  - SDVF Static-Dissipative Vinyl Sheet Flooring
  - VSF Vinyl Sheet Flooring
  - WSVF Wetroom Safety Vinyl Sheet Flooring
- FLOOR BASE LEGEND:**
- FCB Flash Cove Base
  - RB Rubber Base
  - SCF Seamless Cushioned Flooring

**DOORS**

Types:

Type:Qty:	Size (mm):	Material:	Finish:	Side Lt:	Blinds:	Protect.:	Privacy Film:	Function:	Card Reader:	Mag Lock:	Auto Opener:	Hold Open:	Hinges:	Accessory 1:	Accessory 2:	Accessory 3:	Closer:
C2 1	1830 x 2135	Hollow Metal	Paint	<input type="checkbox"/>	<input type="checkbox"/>		<input checked="" type="checkbox"/>	Storeroom	<input checked="" type="checkbox"/>	<input type="checkbox"/>	<input type="checkbox"/>	<input checked="" type="checkbox"/>	Cont. Swing Clear	Astragal	Flush Bolt		Surface

Door Remarks:  Security Grille  Anti-barricade strategy



**MECHANICAL REQUIREMENTS**

<b>PLUMBING</b> (Quantity) Hand Hygiene Sink: <input type="text"/> Lavatory: <input type="text"/> Kitchen Sink: <input type="text"/> Seamless Kitchen Sink: <input type="text"/> Utility / Process Sink: <input type="text"/> Scrub Sink: <input type="text"/> Floor Sink: <input type="text"/>							Other Fixtures: <input type="checkbox"/> Shower <input type="checkbox"/> Eyewash Station <input type="checkbox"/> Tub <input type="checkbox"/> Eyewash/Shower Station <input type="checkbox"/> Ice Maker <input type="checkbox"/> Emergency Shower <input type="checkbox"/> Water Closet <input type="checkbox"/> Flush Rim Sink <input type="checkbox"/> Instantaneous Hot Water <input type="checkbox"/> Floor Drain <input type="checkbox"/> <input type="checkbox"/> Water Bottle Refill Station Other <input type="text"/>				<b>MED / NON-MED GASES</b> (Quantity) Oxygen: <input type="text" value="2"/> Medical Air: <input type="text" value="2"/> Medical Vacuum: <input type="text" value="2"/> Nitrous Oxide: <input type="text"/> CO2: <input type="text"/> AGSS: <input type="text"/> Nitrogen: <input type="text"/> Laboratory Air: <input type="text"/> Laboratory Vacuum: <input type="text"/> Utility Compressed Air: <input type="text"/>					
Plumbing Remarks: <input type="text"/>							Gas Remarks: <input type="text" value="Provide (2) sets of gasses for (2) ventilator testing stations."/>									

**Appendix 1B Minimum Room Requirements**

Room Name:

Program Number(s):

1. N1.01	7.	13.	19.	25.	31.	37.	43.
2.	8.	14.	20.	26.	32.	38.	44.
3.	9.	15.	21.	27.	33.	39.	45.
4.	10.	16.	22.	28.	34.	40.	46.
5.	11.	17.	23.	29.	35.	41.	47.
6.	12.	18.	24.	30.	36.	42.	48.

**ARCHITECTURAL REQUIREMENTS**

<b>WALL AND CEILING</b> Wall Material: <input type="text" value="ARGB 1.2m AFF, GB above"/> Finish: <input type="text" value="PT"/> Ceiling Material: <input type="text" value="ACT"/> Finish: <input type="text" value="PF"/>	<b>WALL PROTECTION</b> Type: <input type="text" value="PVW"/> <input checked="" type="checkbox"/> Corner Guards <input type="checkbox"/> Hand Rails <input type="checkbox"/> Bed Bumper / Locator Height: <input type="text" value="1350 mm"/> <input type="checkbox"/> Crash Rails <input type="checkbox"/> Chair Rail	<b>GLAZING</b> <input type="checkbox"/> Interior Glazing	<b>FLOORING TYPES</b> Material: <input type="text" value="VSF"/> Base: <input type="text" value="FCB"/>	<b>ROOM ACCESSORIES</b> <input checked="" type="checkbox"/> Coat Hooks <input checked="" type="checkbox"/> Ceiling Lift <input checked="" type="checkbox"/> Magnetic Whiteboard <input checked="" type="checkbox"/> Mirror <input type="checkbox"/> Infant Change Table <input checked="" type="checkbox"/> Privacy Curtain
--	---	---	--	---

- LEGEND:**
- WALL AND CEILING LEGEND:**
- AC Architectural Ceiling
  - ACT Acoustic Ceiling Tile
  - ACT-C Cleanroom
  - ARGB Abuse-Resistant Gypsum Board
  - GB Gypsum Board
  - IRGB Impact-Resistant Gypsum Board
  - KLCT Kitchen Lay-in Ceiling Tile
  - MMRGB Moisture and Mould-Resistant Gypsum Board
  - SACT Security Acoustic Ceiling Tile
- WALL FINISHES LEGEND:**
- EWC Epoxy Wall Coating
  - HPC High Performance Coating
  - PT Paint
- CEILING FINISHES LEGEND:**
- ECC Epoxy Ceiling Coating
  - HPC High Performance Coating
  - PF Prefinished
  - PT Paint
- WALL PROTECTION LEGEND:**
- ESRP Extruded Semi-Rigid PVCu Panel
  - FRL Fibre Reinforced Laminate
  - FRP Fibreglass Reinforced Plastic
  - PVW Protective Vinyl Wallcovering
  - RHIS Rigid High Impact Sheet
  - WSSP Wetwall Solid Surface Panel
  - WVV Wetroom Vinyl Wallcovering
- FLOOR FINISHES LEGEND:**
- CFS Concrete Floor Sealer
  - EFC Epoxy Floor Coating
  - PFC Polyurethane Floor Coating
  - RAF Rubber Athletic Flooring
  - RSF Rubber Sheet Flooring
  - SCF Seamless Cushioned Flooring
  - SDRF Static-Dissipative Rubber Sheet Flooring
  - SDVF Static-Dissipative Vinyl Sheet Flooring
  - VSF Vinyl Sheet Flooring
  - WSVF Wetroom Safety Vinyl Sheet Flooring
- FLOOR BASE LEGEND:**
- FCB Flash Cove Base
  - RB Rubber Base
  - SCF Seamless Cushioned Flooring

**DOORS**

Types:

Type:Qty:	Size (mm):	Material:	Finish:	Side Lt:	Blinds:	Protect.:	Privacy Film:	Function:	Card Reader:	Mag Lock:	Auto Opener:	Hold Open:	Hinges:	Accessory 1:	Accessory 2:	Accessory 3:	Closer:

Door Remarks:  Security Grille  Anti-barricade strategy

**MILLWORK AND SPECIALTY CASEWORK**

Storage Requirements:

**UPPER UNITS** (U1-U8) **SHELF** (S1)

**FULL-HEIGHT CABINETS** (C1-C5) **LOWER UNITS** (L1-L12) **RECEPTION/TRANSACTION COUNTER / CARE TEAM STATION DESK** (TC1-TC2) **UTILITY SINK AND COUNTER UNIT** (UC1)

Category	Min. Length (mm)	Motorized Adjustable Height	Standing Height	Specialty Casework
Category 0 - None				
Category 1 - Low (1% - 4%)				
Category 2 - Med (5% - 9%)				
Category 3 - High (10% or Greater)				

**FINISHES**

Full-height Cabinet:   
 Upper Millwork:   
 Countertop:   
 Lower Millwork:   
 Shelf:

Remarks:

**MECHANICAL REQUIREMENTS**

<b>PLUMBING</b> (Quantity) Hand Hygiene Sink: <input type="text" value="1"/> Lavatory: <input type="text"/> Kitchen Sink: <input type="text"/> Seamless Kitchen Sink: <input type="text"/> Utility / Process Sink: <input type="text"/> Scrub Sink: <input type="text"/> Floor Sink: <input type="text"/> Plumbing Remarks: <input type="text"/>	Other Fixtures: <input type="checkbox"/> Shower <input type="checkbox"/> Eyewash Station <input type="checkbox"/> Tub <input type="checkbox"/> Eyewash/Shower Station <input type="checkbox"/> Ice Maker <input type="checkbox"/> Emergency Shower <input type="checkbox"/> Water Closet <input type="checkbox"/> Flush Rim Sink <input type="checkbox"/> Instantaneous Hot Water <input type="checkbox"/> Floor Drain <input type="checkbox"/> <input type="checkbox"/> Water Bottle Refill Station Other: <input type="text"/>	<b>MED / NON-MED GASES</b> (Quantity) Oxygen: <input type="text" value="2"/> Medical Air: <input type="text" value="2"/> Medical Vacuum: <input type="text" value="2"/> Nitrous Oxide: <input type="text"/> CO2: <input type="text"/> AGSS: <input type="text"/> Nitrogen: <input type="text"/> Laboratory Air: <input type="text"/> Laboratory Vacuum: <input type="text"/> Utility Compressed Air: <input type="text"/> Gas Remarks: <input type="text" value="Provide a set of gasses for each treadmill station."/>
---	---	--



**Appendix 1B Minimum Room Requirements**

Room Name: Ventilator Assembly and Testing Room

Program Number(s):

1. N2.02	7.	13.	19.	25.	31.	37.	43.
2.	8.	14.	20.	26.	32.	38.	44.
3.	9.	15.	21.	27.	33.	39.	45.
4.	10.	16.	22.	28.	34.	40.	46.
5.	11.	17.	23.	29.	35.	41.	47.
6.	12.	18.	24.	30.	36.	42.	48.

**ARCHITECTURAL REQUIREMENTS**

<b>WALL AND CEILING</b> Wall Material: ARGB 1.2m AFF, GB above Ceiling Material: ACT Finish: PT Finish: PF	<b>WALL PROTECTION</b> Type: RHIS Height: 1350 mm <input checked="" type="checkbox"/> Corner Guards <input type="checkbox"/> Hand Rails <input type="checkbox"/> Bed Bumper / Locator <input type="checkbox"/> Crash Rails <input type="checkbox"/> Chair Rail	<b>GLAZING</b> <input type="checkbox"/> Interior Glazing	<b>FLOORING TYPES</b> Material: VSF Base: FCB	<b>ROOM ACCESSORIES</b> <input type="checkbox"/> Coat Hooks <input type="checkbox"/> Ceiling Lift <input checked="" type="checkbox"/> Magnetic Whiteboard <input type="checkbox"/> Mirror <input type="checkbox"/> Infant Change Table <input type="checkbox"/> Privacy Curtain
--	---	---	---	---

- LEGEND:**
- WALL AND CEILING LEGEND:**
- AC Architectural Ceiling
  - ACT Acoustic Ceiling Tile
  - ACT-C Cleanroom
  - ARGB Abuse-Resistant Gypsum Board
  - GB Gypsum Board
  - IRGB Impact-Resistant Gypsum Board
  - KLCT Kitchen Lay-in Ceiling Tile
  - MMRGB Moisture and Mould-Resistant Gypsum Board
  - SACT Security Acoustic Ceiling Tile
- WALL FINISHES LEGEND:**
- EWC Epoxy Wall Coating
  - HPC High Performance Coating
  - PT Paint
- CEILING FINISHES LEGEND:**
- ECC Epoxy Ceiling Coating
  - HPC High Performance Coating
  - PF Prefinished
  - PT Paint
- WALL PROTECTION LEGEND:**
- ESRP Extruded Semi-Rigid PVCu Panel
  - FRL Fibre Reinforced Laminated
  - FRP Fibreglass Reinforced Plastic
  - PVV Protective Vinyl Wallcovering
  - RHIS Rigid High Impact Sheet
  - WSSP Wetwall Solid Surface Panel
  - WVV Wetroom Vinyl Wallcovering
- FLOOR FINISHES LEGEND:**
- CFS Concrete Floor Sealer
  - EFC Epoxy Floor Coating
  - PFC Polyurethane Floor Coating
  - RAF Rubber Athletic Flooring
  - RSF Rubber Sheet Flooring
  - SCF Seamless Cushioned Flooring
  - SDRF Static-Dissipative Rubber Sheet Flooring
  - SDVF Static-Dissipative Vinyl Sheet Flooring
  - VSF Vinyl Sheet Flooring
  - WSVF Wetroom Safety Vinyl Sheet Flooring
- FLOOR BASE LEGEND:**
- FCB Flash Cove Base
  - RB Rubber Base
  - SCF Seamless Cushioned Flooring

**DOORS**

Types:

Type	Qty	Size (mm)	Material	Finish	Side Lt	Blinds	Protect	Privacy Film	Function	Card Reader	Mag Lock	Auto Opener	Hold Open	Hinges	Accessory 1	Accessory 2	Accessory 3	Closer
C2	1	1830 x 2135	Solid Core	FRL			2 High		Storeroom	<input checked="" type="checkbox"/>			<input checked="" type="checkbox"/>	Butt Hinge	Astragal	Flush Bolt		Surface

Door Remarks:

Security Grille  
 Anti-barricade strategy

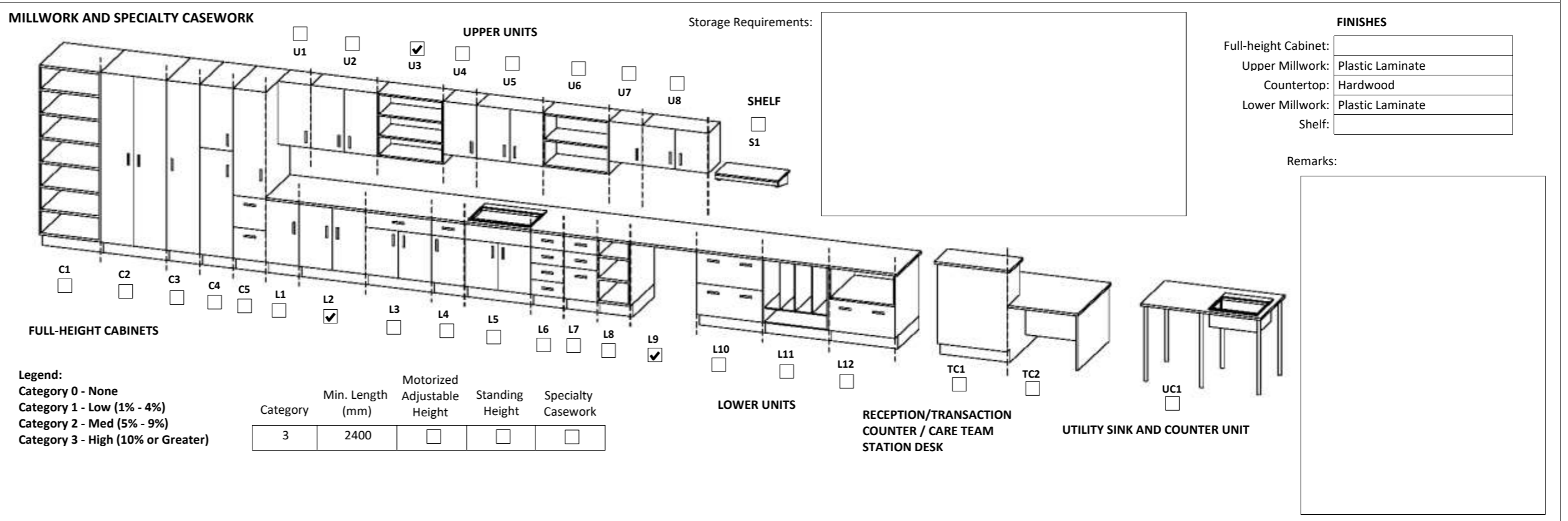

**MECHANICAL REQUIREMENTS**

<b>PLUMBING</b> (Quantity) Hand Hygiene Sink: 1 Lavatory: [ ] Kitchen Sink: [ ] Seamless Kitchen Sink: [ ] Utility / Process Sink: [ ] Scrub Sink: [ ] Floor Sink: [ ] Plumbing Remarks: [ ]	Other Fixtures: <input type="checkbox"/> Shower <input type="checkbox"/> Tub <input type="checkbox"/> Ice Maker <input type="checkbox"/> Water Closet <input type="checkbox"/> Instantaneous Hot Water <input type="checkbox"/> Ewewash Station <input type="checkbox"/> Eyewash/Shower Station <input type="checkbox"/> Emergency Shower <input type="checkbox"/> Flush Rim Sink <input type="checkbox"/> Floor Drain <input type="checkbox"/> Water Bottle Refill Station Other: [ ]	<b>MED / NON-MED GASES</b> (Quantity) Oxygen: 2 Medical Air: 2 Medical Vacuum: 2 Nitrous Oxide: [ ] CO2: [ ] AGSS: [ ] Nitrogen: [ ] Laboratory Air: [ ] Laboratory Vacuum: [ ] Utility Compressed Air: [ ] Gas Remarks: Provide (1) set of medical gasses per ventilator testing station.
---	--	--

---

# New Surrey Hospital & BC Cancer Centre

MINIMUM ROOM REQUIREMENTS

## O. Biomedical Engineering

---

**Appendix 1B Minimum Room Requirements**

Room Name:

Program Number(s):

1. O1.01.02	7.	13.	19.	25.	31.	37.	43.
2.	8.	14.	20.	26.	32.	38.	44.
3.	9.	15.	21.	27.	33.	39.	45.
4.	10.	16.	22.	28.	34.	40.	46.
5.	11.	17.	23.	29.	35.	41.	47.
6.	12.	18.	24.	30.	36.	42.	48.

**ARCHITECTURAL REQUIREMENTS**

<b>WALL AND CEILING</b> Wall Material: <input type="text" value="ARGB 1.2m AFF, GB above"/> Finish: <input type="text" value="PT"/> Ceiling Material: <input type="text" value="ACT"/> Finish: <input type="text" value="PF"/>		<b>WALL PROTECTION</b> Type: <input type="text" value="PVW"/> <input checked="" type="checkbox"/> Corner Guards <input type="checkbox"/> Hand Rails <input type="checkbox"/> Bed Bumper / Locator Height: <input type="text" value="2185 mm"/> <input checked="" type="checkbox"/> Crash Rails <input type="checkbox"/> Chair Rail		<b>GLAZING</b> <input type="checkbox"/> Interior Glazing		<b>FLOORING TYPES</b> Material: <input type="text" value="WSVF"/> Base: <input type="text" value="FCB"/>		<b>ROOM ACCESSORIES</b> <input type="checkbox"/> Coat Hooks <input type="checkbox"/> Ceiling Lift <input type="checkbox"/> Magnetic Whiteboard <input type="checkbox"/> Mirror <input type="checkbox"/> Infant Change Table <input type="checkbox"/> Privacy Curtain	
--	--	--	--	---	--	---	--	--	--

- LEGEND:**
- WALL AND CEILING LEGEND:**
- AC Architectural Ceiling
  - ACT Acoustic Ceiling Tile
  - ACT-C Cleanroom
  - ARGB Abuse-Resistant Gypsum Board
  - GB Gypsum Board
  - IRGB Impact-Resistant Gypsum Board
  - KLCT Kitchen Lay-in Ceiling Tile
  - MMRGB Moisture and Mould-Resistant Gypsum Board
  - SACT Security Acoustic Ceiling Tile
- WALL FINISHES LEGEND:**
- EWC Epoxy Wall Coating
  - HPC High Performance Coating
  - PT Paint
- CEILING FINISHES LEGEND:**
- ECC Epoxy Ceiling Coating
  - HPC High Performance Coating
  - PF Prefinished
  - PT Paint
- WALL PROTECTION LEGEND:**
- ESRP Extruded Semi-Rigid PVCu Panel
  - FRL Fibre Reinforced Laminate
  - FRP Fibreglass Reinforced Plastic
  - PVW Protective Vinyl Wallcovering
  - RHIS Rigid High Impact Sheet
  - WSSP Wetwall Solid Surface Panel
  - WVV Wetroom Vinyl Wallcovering
- FLOOR FINISHES LEGEND:**
- CFS Concrete Floor Sealer
  - EFC Epoxy Floor Coating
  - PFC Polyurethane Floor Coating
  - RAF Rubber Athletic Flooring
  - RSF Rubber Sheet Flooring
  - SCF Seamless Cushioned Flooring
  - SDRF Static-Dissipative Rubber Sheet Flooring
  - SDVF Static-Dissipative Vinyl Sheet Flooring
  - VSF Vinyl Sheet Flooring
  - WSVF Wetroom Safety Vinyl Sheet Flooring
- FLOOR BASE LEGEND:**
- FCB Flash Cove Base
  - RB Rubber Base
  - SCF Seamless Cushioned Flooring

**DOORS**

Types:

Type:Qty:	Size (mm):	Material:	Finish:	Side Lt:	Blinds:	Protect.:	Privacy Film:	Function:	Card Reader:	Mag Lock:	Auto Opener:	Hold Open:	Hinges:	Accessory 1:	Accessory 2:	Accessory 3:	Closer:

Door Remarks:  Security Grille  Anti-barricade strategy

**MILLWORK AND SPECIALTY CASEWORK**

Storage Requirements:

**UPPER UNITS** (U1-U8)

**LOWER UNITS** (L1-L12)

**RECEPTION/TRANSACTION COUNTER / CARE TEAM STATION DESK** (TC1, TC2)

**UTILITY SINK AND COUNTER UNIT** (UC1)

**SHELF** (S1)

**FULL-HEIGHT CABINETS** (C1-C5)

**Legend:**

Category	Min. Length (mm)	Motorized Adjustable Height	Standing Height	Specialty Casework
3	2700	<input type="checkbox"/>	<input checked="" type="checkbox"/>	<input type="checkbox"/>

**FINISHES**

Full-height Cabinet:

Upper Millwork:

Countertop:

Lower Millwork:

Shelf:

Remarks:

**MECHANICAL REQUIREMENTS**

**PLUMBING**

Hand Hygiene Sink:	Lavatory:	Kitchen Sink:	Seamless Kitchen Sink:	Utility / Process Sink:	Scrub Sink:	Floor Sink:
1				1		

Plumbing Remarks:

**Other Fixtures:**

- Shower
- Tub
- Ice Maker
- Water Closet
- Instantaneous Hot Water
- Eyewash Station
- Eyewash/Shower Station
- Emergency Shower
- Flush Rim Sink
- Floor Drain
- Water Bottle Refill Station

Other:

**MED / NON-MED GASES**

Oxygen:	Medical Air:	Medical Vacuum:	Nitrous Oxide:	CO2:	AGSS:	Nitrogen:	Laboratory Air:	Laboratory Vacuum:	Utility Compressed Air:
							1		1

Gas Remarks:



**Appendix 1B Minimum Room Requirements**

Room Name:

Program Number(s):

1. O1.02.01	7.	13.	19.	25.	31.	37.	43.
2.	8.	14.	20.	26.	32.	38.	44.
3.	9.	15.	21.	27.	33.	39.	45.
4.	10.	16.	22.	28.	34.	40.	46.
5.	11.	17.	23.	29.	35.	41.	47.
6.	12.	18.	24.	30.	36.	42.	48.

**ARCHITECTURAL REQUIREMENTS**

<b>WALL AND CEILING</b> Wall Material: <input type="text" value="ARGB 1.2m AFF, GB above"/> Finish: <input type="text" value="PT"/> Ceiling Material: <input type="text" value="ACT"/> Finish: <input type="text" value="PF"/>	<b>WALL PROTECTION</b> Type: <input type="text" value="ESRP"/> <input type="checkbox"/> Corner Guards <input type="checkbox"/> Hand Rails <input type="checkbox"/> Bed Bumper / Locator Height: <input type="text" value="2185 mm"/> <input type="checkbox"/> Crash Rails <input type="checkbox"/> Chair Rail	<b>GLAZING</b> <input type="checkbox"/> Interior Glazing	<b>FLOORING TYPES</b> Material: <input type="text" value="VSF"/> Base: <input type="text" value="FCB"/>	<b>ROOM ACCESSORIES</b> <input type="checkbox"/> Coat Hooks <input type="checkbox"/> Ceiling Lift <input type="checkbox"/> Magnetic Whiteboard <input type="checkbox"/> Mirror <input type="checkbox"/> Infant Change Table <input type="checkbox"/> Privacy Curtain
--	---	---	--	--

- LEGEND:**
- WALL AND CEILING LEGEND:**
- AC Architectural Ceiling
  - ACT Acoustic Ceiling Tile
  - ACT-C Cleanroom
  - ARGB Abuse-Resistant Gypsum Board
  - GB Gypsum Board
  - IRGB Impact-Resistant Gypsum Board
  - KLCT Kitchen Lay-in Ceiling Tile
  - MMRGB Moisture and Mould-Resistant Gypsum Board
  - SACT Security Acoustic Ceiling Tile
- WALL FINISHES LEGEND:**
- EWC Epoxy Wall Coating
  - HPC High Performance Coating
  - PT Paint
- CEILING FINISHES LEGEND:**
- ECC Epoxy Ceiling Coating
  - HPC High Performance Coating
  - PF Prefinished
  - PT Paint
- WALL PROTECTION LEGEND:**
- ESRP Extruded Semi-Rigid PVCu Panel
  - FRL Fibre Reinforced Laminate
  - FRP Fibreglass Reinforced Plastic
  - PVV Protective Vinyl Wallcovering
  - RHIS Rigid High Impact Sheet
  - WSSP Wetwall Solid Surface Panel
  - WVV Wetroom Vinyl Wallcovering
- FLOOR FINISHES LEGEND:**
- CFS Concrete Floor Sealer
  - EFC Epoxy Floor Coating
  - PFC Polyurethane Floor Coating
  - RAF Rubber Athletic Flooring
  - RSF Rubber Sheet Flooring
  - SCF Seamless Cushioned Flooring
  - SDRF Static-Dissipative Rubber Sheet Flooring
  - SDVF Static-Dissipative Vinyl Sheet Flooring
  - VSF Vinyl Sheet Flooring
  - WSVF Wetroom Safety Vinyl Sheet Flooring
- FLOOR BASE LEGEND:**
- FCB Flash Cove Base
  - RB Rubber Base
  - SCF Seamless Cushioned Flooring

**DOORS**

Types:

Type:Qty:	Size (mm):	Material:	Finish:	Side Lt:	Blinds:	Protect.:	Privacy Film:	Function:	Card Reader:	Mag Lock:	Auto Opener:	Hold Open:	Hinges:	Accessory 1:	Accessory 2:	Accessory 3:	Closer:

Door Remarks:  Security Grille  Anti-barricade strategy

**MILLWORK AND SPECIALTY CASEWORK**

Storage Requirements:

**UPPER UNITS** (U1-U8) **SHELF** (S1)

**LOWER UNITS** (L1-L12) **RECEPTION/TRANSACTION COUNTER / CARE TEAM STATION DESK** (TC1-TC2) **UTILITY SINK AND COUNTER UNIT** (UC1)

**FULL-HEIGHT CABINETS** (C1-C5)

**Legend:**

Category	Min. Length (mm)	Motorized Adjustable Height	Standing Height	Specialty Casework
Category 0 - None				
Category 1 - Low (1% - 4%)				
Category 2 - Med (5% - 9%)				
Category 3 - High (10% or Greater)				

**FINISHES**

Full-height Cabinet:   
 Upper Millwork:   
 Countertop:   
 Lower Millwork:   
 Shelf:

Remarks:

**MECHANICAL REQUIREMENTS**

<b>PLUMBING</b> (Quantity) Hand Hygiene Sink: <input type="text" value="1"/> Lavatory: <input type="text"/> Kitchen Sink: <input type="text"/> Seamless Kitchen Sink: <input type="text"/> Utility / Process Sink: <input type="text"/> Scrub Sink: <input type="text"/> Floor Sink: <input type="text"/> Plumbing Remarks: <input type="text"/>	Other Fixtures: <input type="checkbox"/> Shower <input type="checkbox"/> Tub <input type="checkbox"/> Ice Maker <input type="checkbox"/> Water Closet <input type="checkbox"/> Instantaneous Hot Water <input type="checkbox"/> Eyewash Station <input type="checkbox"/> Eyewash/Shower Station <input type="checkbox"/> Emergency Shower <input type="checkbox"/> Flush Rim Sink <input type="checkbox"/> Floor Drain <input type="checkbox"/> Water Bottle Refill Station Other: <input type="text"/>	<b>MED / NON-MED GASES</b> (Quantity) Oxygen: <input type="text"/> Medical Air: <input type="text"/> Medical Vacuum: <input type="text"/> Nitrous Oxide: <input type="text"/> CO2: <input type="text"/> AGSS: <input type="text"/> Nitrogen: <input type="text"/> Laboratory Air: <input type="text"/> Laboratory Vacuum: <input type="text"/> Utility Compressed Air: <input type="text"/> Gas Remarks: <input type="text"/>
--	--	---

# Appendix 1B Minimum Room Requirements

Room Name:

Program Number(s):

1.	O1.01.01	7.		13.		19.		25.		31.		37.		43.
2.		8.		14.		20.		26.		32.		38.		44.
3.		9.		15.		21.		27.		33.		39.		45.
4.		10.		16.		22.		28.		34.		40.		46.
5.		11.		17.		23.		29.		35.		41.		47.
6.		12.		18.		24.		30.		36.		42.		48.

## ARCHITECTURAL REQUIREMENTS

<b>WALL AND CEILING</b> Wall Material: <input type="text" value="MMRGB"/> Finish: <input type="text" value="PT"/> Ceiling Material: <input type="text" value="ACT"/> Finish: <input type="text" value="PF"/>		<b>WALL PROTECTION</b> Type: <input type="text" value="RHIS"/> <input checked="" type="checkbox"/> Corner Guards <input type="checkbox"/> Hand Rails <input type="checkbox"/> Bed Bumper / Locator Height: <input type="text" value="2185 mm"/> <input checked="" type="checkbox"/> Crash Rails <input type="checkbox"/> Chair Rail			<b>GLAZING</b> <input type="checkbox"/> Interior Glazing		<b>FLOORING TYPES</b> Material: <input type="text" value="WSVF"/> Base: <input type="text" value="FCB"/>		<b>ROOM ACCESSORIES</b> <input type="checkbox"/> Coat Hooks <input type="checkbox"/> Ceiling Lift <input type="checkbox"/> Magnetic Whiteboard <input type="checkbox"/> Mirror <input type="checkbox"/> Infant Change Table <input type="checkbox"/> Privacy Curtain		
--	--	---	--	--	---	--	---	--	--	--	--

- LEGEND:**
- WALL AND CEILING LEGEND:**
- AC Architectural Ceiling
  - ACT Acoustic Ceiling Tile
  - ACT-C Cleanroom
  - ARGB Abuse-Resistant Gypsum Board
  - GB Gypsum Board
  - IRGB Impact-Resistant Gypsum Board
  - KLCT Kitchen Lay-in Ceiling Tile
  - MMRGB Moisture and Mould-Resistant Gypsum Board
  - SACT Security Acoustic Ceiling Tile
- WALL FINISHES LEGEND:**
- EWC Epoxy Wall Coating
  - HPC High Performance Coating
  - PT Paint
- CEILING FINISHES LEGEND:**
- ECC Epoxy Ceiling Coating
  - HPC High Performance Coating
  - PF Prefinished
  - PT Paint
- WALL PROTECTION LEGEND:**
- ESRP Extruded Semi-Rigid PVCu Panel
  - FRL Fibre Reinforced Laminate
  - FRP Fibreglass Reinforced Plastic
  - PVVW Protective Vinyl Wallcovering
  - RHIS Rigid High Impact Sheet
  - WSSP Wetwall Solid Surface Panel
  - WVVW Wetroom Vinyl Wallcovering
- FLOOR FINISHES LEGEND:**
- CFS Concrete Floor Sealer
  - EFC Epoxy Floor Coating
  - PFC Polyurethane Floor Coating
  - RAF Rubber Athletic Flooring
  - RSF Rubber Sheet Flooring
  - SCF Seamless Cushioned Flooring
  - SDRF Static-Dissipative Rubber Sheet Flooring
  - SDVF Static-Dissipative Vinyl Sheet Flooring
  - VSF Vinyl Sheet Flooring
  - WSVF Wetroom Safety Vinyl Sheet Flooring
- FLOOR BASE LEGEND:**
- FCB Flash Cove Base
  - RB Rubber Base
  - SCF Seamless Cushioned Flooring

**DOORS**

Types:

Type	Qty	Size (mm)	Material	Finish	Side Lt.	Blinds	Protect.	Privacy Film	Function	Card Reader	Mag Lock	Auto Opener	Hold Open	Hinges	Accessory 1	Accessory 2	Accessory 3	Closer
B2	1	1830 x 2135	Solid Core	FRL	<input type="checkbox"/>	<input type="checkbox"/>	2 High	<input checked="" type="checkbox"/>	Storeroom	<input checked="" type="checkbox"/>	<input type="checkbox"/>	<input type="checkbox"/>	<input checked="" type="checkbox"/>	Butt Hinge	Astragal	Flush Bolt		Surface

Door Remarks:  Security Grille  Anti-barricade strategy



## MECHANICAL REQUIREMENTS

<b>PLUMBING</b> (Quantity) Hygiene Sink: <input type="text" value="1"/> Lavatory: <input type="text"/> Kitchen Sink: <input type="text"/> Seamless Kitchen Sink: <input type="text"/> Utility / Process Sink: <input type="text"/> Scrub Sink: <input type="text"/> Floor Sink: <input type="text"/>							Other Fixtures: <input type="checkbox"/> Shower <input type="checkbox"/> Tub <input type="checkbox"/> Ice Maker <input type="checkbox"/> Water Closet <input type="checkbox"/> Instantaneous Hot Water				<input checked="" type="checkbox"/> Eyewash Station <input type="checkbox"/> Eyewash/Shower Station <input type="checkbox"/> Emergency Shower <input type="checkbox"/> Flush Rim Sink <input checked="" type="checkbox"/> Floor Drain <input type="checkbox"/> Water Bottle Refill Station Other: <input type="text"/>				<b>MED / NON-MED GASES</b> (Quantity) Oxygen: <input type="text"/> Medical Air: <input type="text"/> Medical Vacuum: <input type="text"/> Nitrous Oxide: <input type="text"/> CO2: <input type="text"/> AGSS: <input type="text"/> Nitrogen: <input type="text"/> Laboratory Air: <input type="text"/> Laboratory Vacuum: <input type="text"/> Utility Compressed Air: <input type="text"/>					
Plumbing Remarks: <input type="text" value="Provide HHS at entry point."/>											Gas Remarks: <input type="text"/>									

**Appendix 1B Minimum Room Requirements**

Room Name:

Program Number(s):

1.	O1.03	7.		13.		19.		25.		31.		37.		43.
2.		8.		14.		20.		26.		32.		38.		44.
3.		9.		15.		21.		27.		33.		39.		45.
4.		10.		16.		22.		28.		34.		40.		46.
5.		11.		17.		23.		29.		35.		41.		47.
6.		12.		18.		24.		30.		36.		42.		48.

**ARCHITECTURAL REQUIREMENTS**

<b>WALL AND CEILING</b> Wall Material: <input type="text" value="ARGB 1.2m AFF, GB above"/> Finish: <input type="text" value="PT"/> Ceiling Material: <input type="text" value="ACT"/> Finish: <input type="text" value="PF"/>		<b>WALL PROTECTION</b> Type: <input type="text" value="RHIS"/> <input checked="" type="checkbox"/> Corner Guards <input type="checkbox"/> Hand Rails <input type="checkbox"/> Bed Bumper / Locator Height: <input type="text" value="2185 mm"/> <input type="checkbox"/> Crash Rails <input type="checkbox"/> Chair Rail			<b>GLAZING</b> <input type="checkbox"/> Interior Glazing		<b>FLOORING TYPES</b> Material: <input type="text" value="VSF"/> Base: <input type="text" value="FCB"/>		<b>ROOM ACCESSORIES</b> <input type="checkbox"/> Coat Hooks <input type="checkbox"/> Ceiling Lift <input type="checkbox"/> Magnetic Whiteboard <input type="checkbox"/> Mirror <input type="checkbox"/> Infant Change Table <input type="checkbox"/> Privacy Curtain		
--	--	--	--	--	---	--	--	--	--	--	--

- LEGEND:**
- WALL AND CEILING LEGEND:**
- AC Architectural Ceiling
  - ACT Acoustic Ceiling Tile
  - ACT-C Cleanroom
  - ARGB Abuse-Resistant Gypsum Board
  - GB Gypsum Board
  - IRGB Impact-Resistant Gypsum Board
  - KLCT Kitchen Lay-in Ceiling Tile
  - MMRGB Moisture and Mould-Resistant Gypsum Board
  - SACT Security Acoustic Ceiling Tile
- WALL FINISHES LEGEND:**
- EWC Epoxy Wall Coating
  - HPC High Performance Coating
  - PT Paint
- CEILING FINISHES LEGEND:**
- ECC Epoxy Ceiling Coating
  - HPC High Performance Coating
  - PF Prefinished
  - PT Paint
- WALL PROTECTION LEGEND:**
- ESRP Extruded Semi-Rigid PVCu Panel
  - FRL Fibre Reinforced Laminate
  - FRP Fibreglass Reinforced Plastic
  - PVV Protective Vinyl Wallcovering
  - RHIS Rigid High Impact Sheet
  - WSSP Wetwall Solid Surface Panel
  - WVV Wetroom Vinyl Wallcovering
- FLOOR FINISHES LEGEND:**
- CFS Concrete Floor Sealer
  - EFC Epoxy Floor Coating
  - PFC Polyurethane Floor Coating
  - RAF Rubber Athletic Flooring
  - RSF Rubber Sheet Flooring
  - SCF Seamless Cushioned Flooring
  - SDRF Static-Dissipative Rubber Sheet Flooring
  - SDVF Static-Dissipative Vinyl Sheet Flooring
  - VSF Vinyl Sheet Flooring
  - WSVF Wetroom Safety Vinyl Sheet Flooring
- FLOOR BASE LEGEND:**
- FCB Flash Cove Base
  - RB Rubber Base
  - SCF Seamless Cushioned Flooring

**DOORS**

Types:

Type	Qty	Size (mm)	Material	Finish	Side Lt.	Blinds	Protect.	Privacy Film	Function	Card Reader	Mag Lock	Auto Opener	Hold Open	Hinges	Accessory 1	Accessory 2	Accessory 3	Closer
C2	1	1830 x 2135	Solid Core	FRL	<input type="checkbox"/>	<input type="checkbox"/>	2 High	<input type="checkbox"/>	Storeroom	<input checked="" type="checkbox"/>	<input type="checkbox"/>	<input type="checkbox"/>	<input checked="" type="checkbox"/>	Cont. Swing Clear	Astragal	Flush Bolt		Surface

Door Remarks:  Security Grille  Anti-barricade strategy

Provide shielded glazing in door for laser testing

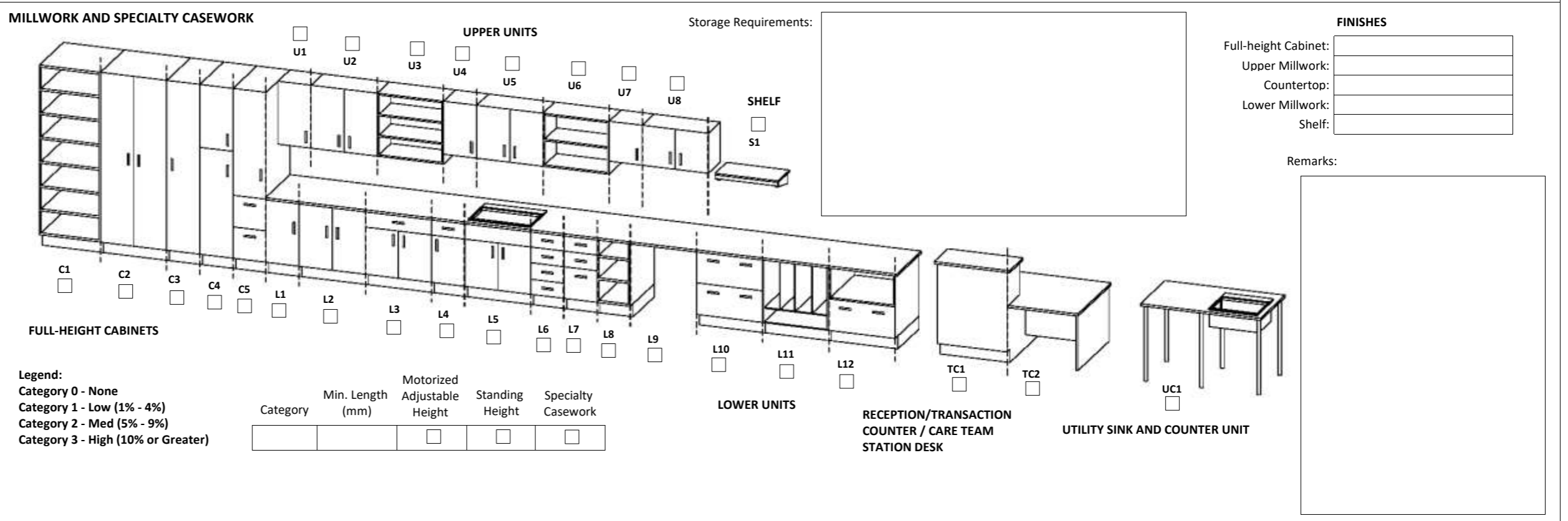

**MECHANICAL REQUIREMENTS**

<b>PLUMBING</b> (Quantity) Hand Hygiene Sink: <input type="text"/> Lavatory: <input type="text"/> Kitchen Sink: <input type="text"/> Seamless Kitchen Sink: <input type="text"/> Utility / Process Sink: <input type="text"/> Scrub Sink: <input type="text"/> Floor Sink: <input type="text"/>							Other Fixtures: <input type="checkbox"/> Shower <input type="checkbox"/> Eyewash Station <input type="checkbox"/> Tub <input type="checkbox"/> Eyewash/Shower Station <input type="checkbox"/> Ice Maker <input type="checkbox"/> Emergency Shower <input type="checkbox"/> Water Closet <input type="checkbox"/> Flush Rim Sink <input type="checkbox"/> Instantaneous Hot Water <input type="checkbox"/> Floor Drain <input type="checkbox"/> Water Bottle Refill Station Other <input type="text"/>				<b>MED / NON-MED GASES</b> (Quantity) Oxygen: <input type="text"/> Medical Air: <input type="text"/> Medical Vacuum: <input type="text"/> Nitrous Oxide: <input type="text"/> CO2: <input type="text"/> AGSS: <input type="text"/> Nitrogen: <input type="text"/> Laboratory Air: <input type="text"/> Laboratory Vacuum: <input type="text"/> Utility Compressed Air: <input type="text"/>				
Plumbing Remarks: <input type="text"/>											Gas Remarks: <input type="text"/>				



**Appendix 1B Minimum Room Requirements**

Room Name:

Program Number(s):

1.	O1.02.04	7.		13.		19.		25.		31.		37.		43.
2.		8.		14.		20.		26.		32.		38.		44.
3.		9.		15.		21.		27.		33.		39.		45.
4.		10.		16.		22.		28.		34.		40.		46.
5.		11.		17.		23.		29.		35.		41.		47.
6.		12.		18.		24.		30.		36.		42.		48.

**ARCHITECTURAL REQUIREMENTS**

<b>WALL AND CEILING</b> Wall Material: <input type="text" value="ARGB 1.2m AFF, GB above"/> Finish: <input type="text" value="PT"/> Ceiling Material: <input type="text" value="ACT"/> Finish: <input type="text" value="PF"/>		<b>WALL PROTECTION</b> Type: <input type="text" value="RHIS"/> <input checked="" type="checkbox"/> Corner Guards <input type="checkbox"/> Hand Rails <input type="checkbox"/> Bed Bumper / Locator Height: <input type="text" value="2185 mm"/> <input checked="" type="checkbox"/> Crash Rails <input type="checkbox"/> Chair Rail			<b>GLAZING</b> <input type="checkbox"/> Interior Glazing		<b>FLOORING TYPES</b> Material: <input type="text" value="VSF"/> Base: <input type="text" value="FCB"/>		<b>ROOM ACCESSORIES</b> <input type="checkbox"/> Coat Hooks <input type="checkbox"/> Ceiling Lift <input type="checkbox"/> Magnetic Whiteboard <input type="checkbox"/> Mirror <input type="checkbox"/> Infant Change Table <input type="checkbox"/> Privacy Curtain		
--	--	---	--	--	---	--	--	--	--	--	--

- LEGEND:**
- WALL AND CEILING LEGEND:**
- AC Architectural Ceiling
  - ACT Acoustic Ceiling Tile
  - ACT-C Cleanroom
  - ARGB Abuse-Resistant Gypsum Board
  - GB Gypsum Board
  - IRGB Impact-Resistant Gypsum Board
  - KLCT Kitchen Lay-in Ceiling Tile
  - MMRGB Moisture and Mould-Resistant Gypsum Board
  - SACT Security Acoustic Ceiling Tile
- WALL FINISHES LEGEND:**
- EWC Epoxy Wall Coating
  - HPC High Performance Coating
  - PT Paint
- CEILING FINISHES LEGEND:**
- ECC Epoxy Ceiling Coating
  - HPC High Performance Coating
  - PF Prefinished
  - PT Paint
- WALL PROTECTION LEGEND:**
- ESRP Extruded Semi-Rigid PVCu Panel
  - FRL Fibre Reinforced Laminate
  - FRP Fibreglass Reinforced Plastic
  - PVV Protective Vinyl Wallcovering
  - RHIS Rigid High Impact Sheet
  - WSSP Wetwall Solid Surface Panel
  - WVV Wetroom Vinyl Wallcovering
- FLOOR FINISHES LEGEND:**
- CFS Concrete Floor Sealer
  - EFC Epoxy Floor Coating
  - PFC Polyurethane Floor Coating
  - RAF Rubber Athletic Flooring
  - RSF Rubber Sheet Flooring
  - SCF Seamless Cushioned Flooring
  - SDRF Static-Dissipative Rubber Sheet Flooring
  - SDVF Static-Dissipative Vinyl Sheet Flooring
  - VSF Vinyl Sheet Flooring
  - WSVF Wetroom Safety Vinyl Sheet Flooring
- FLOOR BASE LEGEND:**
- FCB Flash Cove Base
  - RB Rubber Base
  - SCF Seamless Cushioned Flooring

**DOORS**

Types:

Type	Qty	Size (mm)	Material	Finish	Side Lt.	Blinds	Protect.	Privacy Film	Function	Card Reader	Mag Lock	Auto Opener	Hold Open	Hinges	Accessory 1	Accessory 2	Accessory 3	Closer

Door Remarks:

Security Grille  
 Anti-barricade strategy

**MILLWORK AND SPECIALTY CASEWORK**

Storage Requirements:

**UPPER UNITS** (U1-U8)

**LOWER UNITS** (L1-L12)

**RECEPTION/TRANSACTION COUNTER / CARE TEAM STATION DESK** (TC1, TC2)

**UTILITY SINK AND COUNTER UNIT** (UC1)

**FINISHES**

Full-height Cabinet:   
 Upper Millwork:   
 Countertop:   
 Lower Millwork:   
 Shelf:

Remarks:

**Legend:**

Category	Min. Length (mm)	Motorized Adjustable Height	Standing Height	Specialty Casework
Category 0 - None				
Category 1 - Low (1% - 4%)				
Category 2 - Med (5% - 9%)				
Category 3 - High (10% or Greater)				

**MECHANICAL REQUIREMENTS**

<b>PLUMBING</b> (Quantity) Hand Hygiene Sink: <input type="text"/> Lavatory: <input type="text"/> Kitchen Sink: <input type="text"/> Seamless Kitchen Sink: <input type="text"/> Utility / Process Sink: <input type="text"/> Scrub Sink: <input type="text"/> Floor Sink: <input type="text"/>							Other Fixtures: <input type="checkbox"/> Shower <input type="checkbox"/> Tub <input type="checkbox"/> Ice Maker <input type="checkbox"/> Water Closet <input type="checkbox"/> Instantaneous Hot Water			<input type="checkbox"/> Eyewash Station <input type="checkbox"/> Eyewash/Shower Station <input type="checkbox"/> Emergency Shower <input type="checkbox"/> Flush Rim Sink <input type="checkbox"/> Floor Drain <input type="checkbox"/> Water Bottle Refill Station			<b>MED / NON-MED GASES</b> (Quantity) Oxygen: <input type="text"/> Medical Air: <input type="text"/> Medical Vacuum: <input type="text"/> Nitrous Oxide: <input type="text"/> CO2: <input type="text"/> AGSS: <input type="text"/> Nitrogen: <input type="text"/> Laboratory Air: <input type="text"/> Laboratory Vacuum: <input type="text"/> Utility Compressed Air: <input type="text"/>				
Plumbing Remarks: <input type="text"/>							Gas Remarks: <input type="text"/>										

**Appendix 1B Minimum Room Requirements**

Room Name:

Program Number(s):

1.	O1.02.02	7.		13.		19.		25.		31.		37.		43.
2.		8.		14.		20.		26.		32.		38.		44.
3.		9.		15.		21.		27.		33.		39.		45.
4.		10.		16.		22.		28.		34.		40.		46.
5.		11.		17.		23.		29.		35.		41.		47.
6.		12.		18.		24.		30.		36.		42.		48.

**ARCHITECTURAL REQUIREMENTS**

<b>WALL AND CEILING</b> Wall Material: <input type="text" value="MMRGB"/> Finish: <input type="text" value="PT"/> Ceiling Material: <input type="text" value="ACT"/> Finish: <input type="text" value="PF"/>	<b>WALL PROTECTION</b> Type: <input type="text" value="RHIS"/> <input checked="" type="checkbox"/> Corner Guards <input type="checkbox"/> Hand Rails <input type="checkbox"/> Bed Bumper / Locator Height: <input type="text" value="2185 mm"/> <input type="checkbox"/> Crash Rails <input checked="" type="checkbox"/> Chair Rail	<b>GLAZING</b> <input type="checkbox"/> Interior Glazing	<b>FLOORING TYPES</b> Material: <input type="text" value="SDVF"/> Base: <input type="text" value="FCB"/>	<b>ROOM ACCESSORIES</b> <input checked="" type="checkbox"/> Coat Hooks <input type="checkbox"/> Ceiling Lift <input checked="" type="checkbox"/> Magnetic Whiteboard <input type="checkbox"/> Mirror <input type="checkbox"/> Infant Change Table <input type="checkbox"/> Privacy Curtain
--	---	---	---	--

- LEGEND:**
- WALL AND CEILING LEGEND:**
- AC Architectural Ceiling
  - ACT Acoustic Ceiling Tile
  - ACT-C Cleanroom
  - ARGB Abuse-Resistant Gypsum Board
  - GB Gypsum Board
  - IRGB Impact-Resistant Gypsum Board
  - KLCT Kitchen Lay-in Ceiling Tile
  - MMRGB Moisture and Mould-Resistant Gypsum Board
  - SACT Security Acoustic Ceiling Tile
- WALL FINISHES LEGEND:**
- EWC Epoxy Wall Coating
  - HPC High Performance Coating
  - PT Paint
- CEILING FINISHES LEGEND:**
- ECC Epoxy Ceiling Coating
  - HPC High Performance Coating
  - PF Prefinished
  - PT Paint
- WALL PROTECTION LEGEND:**
- ESRP Extruded Semi-Rigid PVCu Panel
  - FRL Fibre Reinforced Laminate
  - FRP Fibreglass Reinforced Plastic
  - PVV Protective Vinyl Wallcovering
  - RHIS Rigid High Impact Sheet
  - WSSP Wetwall Solid Surface Panel
  - WVV Wetroom Vinyl Wallcovering
- FLOOR FINISHES LEGEND:**
- CFS Concrete Floor Sealer
  - EFC Epoxy Floor Coating
  - PFC Polyurethane Floor Coating
  - RAF Rubber Athletic Flooring
  - RSF Rubber Sheet Flooring
  - SCF Seamless Cushioned Flooring
  - SDRF Static-Dissipative Rubber Sheet Flooring
  - SDVF Static-Dissipative Vinyl Sheet Flooring
  - VSF Vinyl Sheet Flooring
  - WSVF Wetroom Safety Vinyl Sheet Flooring
- FLOOR BASE LEGEND:**
- FCB Flash Cove Base
  - RB Rubber Base
  - SCF Seamless Cushioned Flooring

**DOORS**

Types:

Type:Qty:	Size (mm):	Material:	Finish:	Side Lt:	Blinds:	Protect.:	Privacy Film:	Function:	Card Reader:	Mag Lock:	Auto Opener:	Hold Open:	Hinges:	Accessory 1:	Accessory 2:	Accessory 3:	Closer:	

Door Remarks:  Security Grille  Anti-barricade strategy



**MECHANICAL REQUIREMENTS**

<b>PLUMBING</b> (Quantity) Hand Hygiene Sink: <input type="text" value="1"/> Lavatory: <input type="text"/> Kitchen Sink: <input type="text"/> Seamless Kitchen Sink: <input type="text"/> Utility / Process Sink: <input type="text"/> Scrub Sink: <input type="text"/> Floor Sink: <input type="text"/> Plumbing Remarks: <input type="text"/>	Other Fixtures: <input type="checkbox"/> Shower <input type="checkbox"/> Eyewash Station <input type="checkbox"/> Tub <input type="checkbox"/> Eyewash/Shower Station <input type="checkbox"/> Ice Maker <input type="checkbox"/> Emergency Shower <input type="checkbox"/> Water Closet <input type="checkbox"/> Flush Rim Sink <input type="checkbox"/> Instantaneous Hot Water <input type="checkbox"/> Floor Drain <input type="checkbox"/> <input type="checkbox"/> Water Bottle Refill Station Other: <input type="text"/>	<b>MED / NON-MED GASES</b> (Quantity) Oxygen: <input type="text" value="6"/> Medical Air: <input type="text" value="4"/> Medical Vacuum: <input type="text" value="6"/> Nitrous Oxide: <input type="text" value="0"/> CO2: <input type="text"/> AGSS: <input type="text" value="2"/> Nitrogen: <input type="text" value="2"/> Laboratory Air: <input type="text" value="6"/> Laboratory Vacuum: <input type="text"/> Utility Compressed Air: <input type="text" value="6"/> Gas Remarks: <input type="text" value="Provide Niederman exhaust arm. Gasses at each (6) workstation, (2) stations to have additional NO, AGSS."/>
---	---	---

**Appendix 1B Minimum Room Requirements**

Room Name:

Program Number(s):

1.	O1.02.03	7.		13.		19.		25.		31.		37.		43.
2.		8.		14.		20.		26.		32.		38.		44.
3.		9.		15.		21.		27.		33.		39.		45.
4.		10.		16.		22.		28.		34.		40.		46.
5.		11.		17.		23.		29.		35.		41.		47.
6.		12.		18.		24.		30.		36.		42.		48.

**ARCHITECTURAL REQUIREMENTS**

<b>WALL AND CEILING</b> Wall Material: <input type="text" value="ARGB 1.2m AFF, GB above"/> Finish: <input type="text" value="PT"/> Ceiling Material: <input type="text" value="ACT"/> Finish: <input type="text" value="PF"/>		<b>WALL PROTECTION</b> Type: <input type="text" value="RHIS"/> <input type="checkbox"/> Corner Guards <input type="checkbox"/> Hand Rails <input type="checkbox"/> Bed Bumper / Locator Height: <input type="text" value="2185 mm"/> <input type="checkbox"/> Crash Rails <input type="checkbox"/> Chair Rail			<b>GLAZING</b> <input type="checkbox"/> Interior Glazing		<b>FLOORING TYPES</b> Material: <input type="text" value="SDVF"/> Base: <input type="text" value="FCB"/>		<b>ROOM ACCESSORIES</b> <input type="checkbox"/> Coat Hooks <input type="checkbox"/> Ceiling Lift <input type="checkbox"/> Magnetic Whiteboard <input type="checkbox"/> Mirror <input type="checkbox"/> Infant Change Table <input type="checkbox"/> Privacy Curtain		
--	--	---	--	--	---	--	---	--	--	--	--

- LEGEND:**
- WALL AND CEILING LEGEND:**
- AC Architectural Ceiling
  - ACT Acoustic Ceiling Tile
  - ACT-C Cleanroom
  - ARGB Abuse-Resistant Gypsum Board
  - GB Gypsum Board
  - IRGB Impact-Resistant Gypsum Board
  - KLCT Kitchen Lay-in Ceiling Tile
  - MMRGB Moisture and Mould-Resistant Gypsum Board
  - SACT Security Acoustic Ceiling Tile
- WALL FINISHES LEGEND:**
- EWC Epoxy Wall Coating
  - HPC High Performance Coating
  - PT Paint
- CEILING FINISHES LEGEND:**
- ECC Epoxy Ceiling Coating
  - HPC High Performance Coating
  - PF Prefinished
  - PT Paint
- WALL PROTECTION LEGEND:**
- ESRP Extruded Semi-Rigid PVCu Panel
  - FRL Fibre Reinforced Laminate
  - FRP Fibreglass Reinforced Plastic
  - PVW Protective Vinyl Wallcovering
  - RHIS Rigid High Impact Sheet
  - WSSP Wetwall Solid Surface Panel
  - WVV Wetroom Vinyl Wallcovering
- FLOOR FINISHES LEGEND:**
- CFS Concrete Floor Sealer
  - EFC Epoxy Floor Coating
  - PFC Polyurethane Floor Coating
  - RAF Rubber Athletic Flooring
  - RSF Rubber Sheet Flooring
  - SCF Seamless Cushioned Flooring
  - SDRF Static-Dissipative Rubber Sheet Flooring
  - SDVF Static-Dissipative Vinyl Sheet Flooring
  - VSF Vinyl Sheet Flooring
  - WSVF Wetroom Safety Vinyl Sheet Flooring
- FLOOR BASE LEGEND:**
- FCB Flash Cove Base
  - RB Rubber Base
  - SCF Seamless Cushioned Flooring

**DOORS**

Types:

Type:Qty:	Size (mm):	Material:	Finish:	Side Lt:	Blinds:	Protect.:	Privacy Film:	Function:	Card Reader:	Mag Lock:	Auto Opener:	Hold Open:	Hinges:	Accessory 1:	Accessory 2:	Accessory 3:	Closer:

Door Remarks:  Security Grille  Anti-barricade strategy

**MILLWORK AND SPECIALTY CASEWORK**

Storage Requirements:

**UPPER UNITS** U1 U2 U3 U4 U5 U6 U7 U8

**LOWER UNITS** L10 L11 L12

**RECEPTION/TRANSACTION COUNTER / CARE TEAM STATION DESK** TC1 TC2

**UTILITY SINK AND COUNTER UNIT** UC1

**SHELF** S1

**FULL-HEIGHT CABINETS** C1 C2 C3 C4 C5

**Legend:**

Category	Min. Length (mm)	Motorized Adjustable Height	Standing Height	Specialty Casework
Category 0 - None				
Category 1 - Low (1% - 4%)				
Category 2 - Med (5% - 9%)				
Category 3 - High (10% or Greater)				

**FINISHES**

Full-height Cabinet:

Upper Millwork:

Countertop:

Lower Millwork:

Shelf:

Remarks:

**MECHANICAL REQUIREMENTS**

<b>PLUMBING</b> (Quantity) Hand Hygiene Sink: <input type="text"/> Lavatory: <input type="text"/> Kitchen Sink: <input type="text"/> Seamless Kitchen Sink: <input type="text"/> Utility / Process Sink: <input type="text"/> Scrub Sink: <input type="text"/> Floor Sink: <input type="text"/>							Other Fixtures: <input type="checkbox"/> Shower <input type="checkbox"/> Eyewash Station <input type="checkbox"/> Tub <input type="checkbox"/> Eyewash/Shower Station <input type="checkbox"/> Ice Maker <input type="checkbox"/> Emergency Shower <input type="checkbox"/> Water Closet <input type="checkbox"/> Flush Rim Sink <input type="checkbox"/> Instantaneous Hot Water <input type="checkbox"/> Floor Drain <input type="checkbox"/> Water Bottle Refill Station Other <input type="text"/>				<b>MED / NON-MED GASES</b> (Quantity) Oxygen: <input type="text"/> Medical Air: <input type="text"/> Medical Vacuum: <input type="text"/> Nitrous Oxide: <input type="text"/> CO2: <input type="text"/> AGSS: <input type="text"/> Nitrogen: <input type="text"/> Laboratory Air: <input type="text"/> Laboratory Vacuum: <input type="text"/> Utility Compressed Air: <input type="text"/>					
Plumbing Remarks: <input type="text"/>							Gas Remarks: <input type="text"/>									



---

# New Surrey Hospital & BC Cancer Centre

MINIMUM ROOM REQUIREMENTS

## **P. Medical Devices Reprocessing**

---

**Appendix 1B Minimum Room Requirements**

Room Name:

Program Number(s):

1.	P2.03.08	7.		13.		19.		25.		31.		37.		43.
2.		8.		14.		20.		26.		32.		38.		44.
3.		9.		15.		21.		27.		33.		39.		45.
4.		10.		16.		22.		28.		34.		40.		46.
5.		11.		17.		23.		29.		35.		41.		47.
6.		12.		18.		24.		30.		36.		42.		48.

**ARCHITECTURAL REQUIREMENTS**

<b>WALL AND CEILING</b> Wall Material: <input type="text" value="ARGB 1.2m AFF, GB above"/> Finish: <input type="text" value="HPC"/> Ceiling Material: <input type="text" value="MMRGB"/> Finish: <input type="text" value="HPC"/>		<b>WALL PROTECTION</b> Type: <input type="text" value="ESRP"/> <input checked="" type="checkbox"/> Corner Guards <input type="checkbox"/> Hand Rails <input type="checkbox"/> Bed Bumper / Locator Height: <input type="text" value="2185 mm"/> <input type="checkbox"/> Crash Rails <input type="checkbox"/> Chair Rail			<b>GLAZING</b> <input type="checkbox"/> Interior Glazing		<b>FLOORING TYPES</b> Material: <input type="text" value="WSVF"/> Base: <input type="text" value="FCB"/>		<b>ROOM ACCESSORIES</b> <input type="checkbox"/> Coat Hooks <input type="checkbox"/> Ceiling Lift <input type="checkbox"/> Magnetic Whiteboard <input type="checkbox"/> Mirror <input type="checkbox"/> Infant Change Table <input type="checkbox"/> Privacy Curtain		
--	--	--	--	--	---	--	---	--	--	--	--

- LEGEND:**
- WALL AND CEILING LEGEND:**
- AC Architectural Ceiling
  - ACT Acoustic Ceiling Tile
  - ACT-C Cleanroom
  - ARGB Abuse-Resistant Gypsum Board
  - GB Gypsum Board
  - IRGB Impact-Resistant Gypsum Board
  - KLCT Kitchen Lay-in Ceiling Tile
  - MMRGB Moisture and Mould-Resistant Gypsum Board
  - SACT Security Acoustic Ceiling Tile
- WALL FINISHES LEGEND:**
- EWC Epoxy Wall Coating
  - HPC High Performance Coating
  - PT Paint
- CEILING FINISHES LEGEND:**
- ECC Epoxy Ceiling Coating
  - HPC High Performance Coating
  - PF Prefinished
  - PT Paint
- WALL PROTECTION LEGEND:**
- ESRP Extruded Semi-Rigid PVCu Panel
  - FRL Fibre Reinforced Laminate
  - FRP Fibreglass Reinforced Plastic
  - PVV Protective Vinyl Wallcovering
  - RHIS Rigid High Impact Sheet
  - WSSP Wetwall Solid Surface Panel
  - WVV Wetroom Vinyl Wallcovering
- FLOOR FINISHES LEGEND:**
- CFS Concrete Floor Sealer
  - EFC Epoxy Floor Coating
  - PFC Polyurethane Floor Coating
  - RAF Rubber Athletic Flooring
  - RSF Rubber Sheet Flooring
  - SCF Seamless Cushioned Flooring
  - SDRF Static-Dissipative Rubber Sheet Flooring
  - SDVF Static-Dissipative Vinyl Sheet Flooring
  - VSF Vinyl Sheet Flooring
  - WSVF Wetroom Safety Vinyl Sheet Flooring
- FLOOR BASE LEGEND:**
- FCB Flash Cove Base
  - RB Rubber Base
  - SCF Seamless Cushioned Flooring

**DOORS**

Types:

Type	Qty	Size (mm)	Material	Finish	Side Lt.	Blinds	Protect.	Privacy Film	Function	Card Reader	Mag Lock	Auto Opener	Hold Open	Hinges	Accessory 1	Accessory 2	Accessory 3	Closer

Door Remarks:  Security Grille  Anti-barricade strategy

**MILLWORK AND SPECIALTY CASEWORK**

**UPPER UNITS** (U1-U8) **LOWER UNITS** (L1-L12) **RECEPTION/TRANSACTION COUNTER / CARE TEAM STATION DESK** (TC1-TC2) **UTILITY SINK AND COUNTER UNIT** (UC1)

Storage Requirements:

**FINISHES**

Full-height Cabinet:   
 Upper Millwork:   
 Countertop:   
 Lower Millwork:   
 Shelf:

Remarks:

**Legend:**

Category	Min. Length (mm)	Motorized Adjustable Height	Standing Height	Specialty Casework
Category 0 - None				
Category 1 - Low (1% - 4%)				
Category 2 - Med (5% - 9%)				
Category 3 - High (10% or Greater)				

**MECHANICAL REQUIREMENTS**

<b>PLUMBING</b> (Quantity) Hand Hygiene Sink: <input type="text"/> Lavatory: <input type="text"/> Kitchen Sink: <input type="text"/> Seamless Kitchen Sink: <input type="text"/> Utility / Process Sink: <input type="text"/> Scrub Sink: <input type="text"/> Floor Sink: <input type="text"/>							Other Fixtures: <input type="checkbox"/> Shower <input type="checkbox"/> Eyewash Station <input type="checkbox"/> Tub <input type="checkbox"/> Eyewash/Shower Station <input type="checkbox"/> Ice Maker <input type="checkbox"/> Emergency Shower <input type="checkbox"/> Water Closet <input type="checkbox"/> Flush Rim Sink <input type="checkbox"/> Instantaneous Hot Water <input type="checkbox"/> Floor Drain <input type="checkbox"/> Water Bottle Refill Station Other <input type="text"/>				<b>MED / NON-MED GASES</b> (Quantity) Oxygen: <input type="text"/> Medical Air: <input type="text"/> Medical Vacuum: <input type="text"/> Nitrous Oxide: <input type="text"/> CO2: <input type="text"/> AGSS: <input type="text"/> Nitrogen: <input type="text"/> Laboratory Air: <input type="text"/> Laboratory Vacuum: <input type="text"/> Utility Compressed Air: <input type="text"/>				
Plumbing Remarks: <input type="text"/>							Gas Remarks: <input type="text"/>								

**Appendix 1B Minimum Room Requirements**

Room Name:

Program Number(s):

1. P2.01	7.	13.	19.	25.	31.	37.	43.
2.	8.	14.	20.	26.	32.	38.	44.
3.	9.	15.	21.	27.	33.	39.	45.
4.	10.	16.	22.	28.	34.	40.	46.
5.	11.	17.	23.	29.	35.	41.	47.
6.	12.	18.	24.	30.	36.	42.	48.

**ARCHITECTURAL REQUIREMENTS**

<b>WALL AND CEILING</b> Wall Material: <input type="text" value="ARGB 1.2m AFF, GB above"/> Finish: <input type="text" value="HPC"/> Ceiling Material: <input type="text" value="MMRGB"/> Finish: <input type="text" value="HPC"/>		<b>WALL PROTECTION</b> Type: <input type="text" value="ESRP"/> <input checked="" type="checkbox"/> Corner Guards <input type="checkbox"/> Hand Rails <input type="checkbox"/> Bed Bumper / Locator Height: <input type="text" value="2185 mm"/> <input type="checkbox"/> Crash Rails <input type="checkbox"/> Chair Rail		<b>GLAZING</b> <input type="checkbox"/> Interior Glazing		<b>FLOORING TYPES</b> Material: <input type="text" value="WSVF"/> Base: <input type="text" value="FCB"/>		<b>ROOM ACCESSORIES</b> <input checked="" type="checkbox"/> Coat Hooks <input type="checkbox"/> Ceiling Lift <input type="checkbox"/> Magnetic Whiteboard <input type="checkbox"/> Mirror <input type="checkbox"/> Infant Change Table <input type="checkbox"/> Privacy Curtain	
--	--	--	--	---	--	---	--	---	--

- LEGEND:**
- WALL AND CEILING LEGEND:**
- AC Architectural Ceiling
  - ACT Acoustic Ceiling Tile
  - ACT-C Cleanroom
  - ARGB Abuse-Resistant Gypsum Board
  - GB Gypsum Board
  - IRGB Impact-Resistant Gypsum Board
  - KLCT Kitchen Lay-in Ceiling Tile
  - MMRGB Moisture and Mould-Resistant Gypsum Board
  - SACT Security Acoustic Ceiling Tile
- WALL FINISHES LEGEND:**
- EWC Epoxy Wall Coating
  - HPC High Performance Coating
  - PT Paint
- CEILING FINISHES LEGEND:**
- ECC Epoxy Ceiling Coating
  - HPC High Performance Coating
  - PF Prefinished
  - PT Paint
- WALL PROTECTION LEGEND:**
- ESRP Extruded Semi-Rigid PVCu Panel
  - FRL Fibre Reinforced Laminate
  - FRP Fibreglass Reinforced Plastic
  - PVV Protective Vinyl Wallcovering
  - RHIS Rigid High Impact Sheet
  - WSSP Wetwall Solid Surface Panel
  - WVV Wetroom Vinyl Wallcovering
- FLOOR FINISHES LEGEND:**
- CFS Concrete Floor Sealer
  - EFC Epoxy Floor Coating
  - PFC Polyurethane Floor Coating
  - RAF Rubber Athletic Flooring
  - RSF Rubber Sheet Flooring
  - SCF Seamless Cushioned Flooring
  - SDRF Static-Dissipative Rubber Sheet Flooring
  - SDVF Static-Dissipative Vinyl Sheet Flooring
  - VSF Vinyl Sheet Flooring
  - WSVF Wetroom Safety Vinyl Sheet Flooring
- FLOOR BASE LEGEND:**
- FCB Flash Cove Base
  - RB Rubber Base
  - SCF Seamless Cushioned Flooring

**DOORS**

Types:

Type	Qty	Size (mm)	Material	Finish	Side Lt.	Blinds	Protect.	Privacy Film	Function	Card Reader	Mag Lock	Auto Opener	Hold Open	Hinges	Accessory 1	Accessory 2	Accessory 3	Closer
B	1	1220 x 2135	Hollow Metal	Paint	<input type="checkbox"/>	<input type="checkbox"/>	2 High	<input type="checkbox"/>	Storeroom	<input checked="" type="checkbox"/>	<input type="checkbox"/>	<input type="checkbox"/>	<input type="checkbox"/>	Butt Hinge				Concealed
B	1	1220 x 2135	Hollow Metal	Paint	<input type="checkbox"/>	<input type="checkbox"/>	2 High	<input type="checkbox"/>	Passage	<input type="checkbox"/>	<input type="checkbox"/>	<input type="checkbox"/>	<input type="checkbox"/>	Butt Hinge				Concealed

Door Remarks:  Security Grille  Anti-barricade strategy

**MILLWORK AND SPECIALTY CASEWORK**

Storage Requirements:

**UPPER UNITS** (U1-U8) **SHELF** (S1)

**FULL-HEIGHT CABINETS** (C1-C5) **LOWER UNITS** (L1-L12) **RECEPTION/TRANSACTION COUNTER / CARE TEAM STATION DESK** (TC1-TC2) **UTILITY SINK AND COUNTER UNIT** (UC1)

Category	Min. Length (mm)	Motorized Adjustable Height	Standing Height	Specialty Casework
Category 0 - None		<input type="checkbox"/>	<input type="checkbox"/>	<input type="checkbox"/>
Category 1 - Low (1% - 4%)		<input type="checkbox"/>	<input type="checkbox"/>	<input type="checkbox"/>
Category 2 - Med (5% - 9%)		<input type="checkbox"/>	<input type="checkbox"/>	<input type="checkbox"/>
Category 3 - High (10% or Greater)		<input type="checkbox"/>	<input type="checkbox"/>	<input type="checkbox"/>

**FINISHES**

Full-height Cabinet:   
 Upper Millwork:   
 Countertop:   
 Lower Millwork:   
 Shelf:

Remarks:

**MECHANICAL REQUIREMENTS**

<b>PLUMBING</b> (Quantity)		Hand Hygiene Sink: <input type="text" value="1"/> Lavatory: <input type="text"/> Kitchen Sink: <input type="text"/> Seamless Kitchen Sink: <input type="text"/> Utility / Process Sink: <input type="text"/> Scrub Sink: <input type="text"/> Floor Sink: <input type="text"/>							Other Fixtures: <input type="checkbox"/> Shower <input type="checkbox"/> Tub <input type="checkbox"/> Ice Maker <input type="checkbox"/> Water Closet <input type="checkbox"/> Instantaneous Hot Water				<input type="checkbox"/> Eyewash Station <input type="checkbox"/> Eyewash/Shower Station <input type="checkbox"/> Emergency Shower <input type="checkbox"/> Flush Rim Sink <input type="checkbox"/> Floor Drain <input type="checkbox"/> Water Bottle Refill Station				<b>MED / NON-MED GASES</b> (Quantity)					
Plumbing Remarks: <input type="text"/>		Oxygen: <input type="text"/>		Medical Air: <input type="text"/>		Medical Vacuum: <input type="text"/>		Nitrous Oxide: <input type="text"/>		CO2: <input type="text"/>		AGSS: <input type="text"/>		Nitrogen: <input type="text"/>		Laboratory Air: <input type="text"/>		Laboratory Vacuum: <input type="text"/>		Utility Compressed Air: <input type="text"/>		
		Gas Remarks: <input type="text"/>																				



**Appendix 1B Minimum Room Requirements**

Room Name:

Program Number(s):

1. P1.02	7.	13.	19.	25.	31.	37.	43.
2.	8.	14.	20.	26.	32.	38.	44.
3.	9.	15.	21.	27.	33.	39.	45.
4.	10.	16.	22.	28.	34.	40.	46.
5.	11.	17.	23.	29.	35.	41.	47.
6.	12.	18.	24.	30.	36.	42.	48.

**ARCHITECTURAL REQUIREMENTS**

<b>WALL AND CEILING</b> Wall Material: <input type="text" value="ARGB 1.2m AFF, GB above"/> Finish: <input type="text" value="HPC"/> Ceiling Material: <input type="text" value="MMRGB"/> Finish: <input type="text" value="HPC"/>		<b>WALL PROTECTION</b> Type: <input type="text" value="ESRP"/> <input checked="" type="checkbox"/> Corner Guards <input type="checkbox"/> Hand Rails <input type="checkbox"/> Bed Bumper / Locator Height: <input type="text" value="2185 mm"/> <input type="checkbox"/> Crash Rails <input type="checkbox"/> Chair Rail		<b>GLAZING</b> <input type="checkbox"/> Interior Glazing		<b>FLOORING TYPES</b> Material: <input type="text" value="WSVF"/> Base: <input type="text" value="FCB"/>		<b>ROOM ACCESSORIES</b> <input checked="" type="checkbox"/> Coat Hooks <input type="checkbox"/> Ceiling Lift <input type="checkbox"/> Magnetic Whiteboard <input type="checkbox"/> Mirror <input type="checkbox"/> Infant Change Table <input type="checkbox"/> Privacy Curtain	
--	--	--	--	---	--	---	--	---	--

- LEGEND:**
- WALL AND CEILING LEGEND:**
- AC Architectural Ceiling
  - ACT Acoustic Ceiling Tile
  - ACT-C Cleanroom
  - ARGB Abuse-Resistant Gypsum Board
  - GB Gypsum Board
  - IRGB Impact-Resistant Gypsum Board
  - KLCT Kitchen Lay-in Ceiling Tile
  - MMRGB Moisture and Mould-Resistant Gypsum Board
  - SACT Security Acoustic Ceiling Tile
- WALL FINISHES LEGEND:**
- EWC Epoxy Wall Coating
  - HPC High Performance Coating
  - PT Paint
- CEILING FINISHES LEGEND:**
- ECC Epoxy Ceiling Coating
  - HPC High Performance Coating
  - PF Prefinished
  - PT Paint
- WALL PROTECTION LEGEND:**
- ESRP Extruded Semi-Rigid PVCu Panel
  - FRL Fibre Reinforced Laminate
  - FRP Fibreglass Reinforced Plastic
  - PVV Protective Vinyl Wallcovering
  - RHIS Rigid High Impact Sheet
  - WSSP Wetwall Solid Surface Panel
  - WVV Wetroom Vinyl Wallcovering
- FLOOR FINISHES LEGEND:**
- CFS Concrete Floor Sealer
  - EFC Epoxy Floor Coating
  - PFC Polyurethane Floor Coating
  - RAF Rubber Athletic Flooring
  - RSF Rubber Sheet Flooring
  - SCF Seamless Cushioned Flooring
  - SDRF Static-Dissipative Rubber Sheet Flooring
  - SDVF Static-Dissipative Vinyl Sheet Flooring
  - VSF Vinyl Sheet Flooring
  - WSVF Wetroom Safety Vinyl Sheet Flooring
- FLOOR BASE LEGEND:**
- FCB Flash Cove Base
  - RB Rubber Base
  - SCF Seamless Cushioned Flooring

**DOORS**

Types:

Type	Qty	Size (mm)	Material	Finish	Side Lt.	Blinds	Protect.	Privacy Film	Function	Card Reader	Mag Lock	Auto Opener	Hold Open	Hinges	Accessory 1	Accessory 2	Accessory 3	Closer
B	1	1220 x 2135	Hollow Metal	Paint	<input type="checkbox"/>	<input type="checkbox"/>	2 High	<input type="checkbox"/>	Storeroom	<input checked="" type="checkbox"/>	<input type="checkbox"/>	<input type="checkbox"/>	<input type="checkbox"/>	Butt Hinge				Concealed
B	1	1220 x 2135	Hollow Metal	Paint	<input type="checkbox"/>	<input type="checkbox"/>	2 High	<input type="checkbox"/>	Passage	<input type="checkbox"/>	<input type="checkbox"/>	<input type="checkbox"/>	<input type="checkbox"/>	Butt Hinge				Concealed

Door Remarks:  Security Grille  Anti-barricade strategy

**MILLWORK AND SPECIALTY CASEWORK**

**UPPER UNITS** (U1-U8) **LOWER UNITS** (L1-L12) **RECEPTION/TRANSACTION COUNTER / CARE TEAM STATION DESK** (TC1-TC2) **UTILITY SINK AND COUNTER UNIT** (UC1)

Storage Requirements:

**FINISHES**

Full-height Cabinet:   
 Upper Millwork:   
 Countertop:   
 Lower Millwork:   
 Shelf:

Remarks:

**Legend:**

Category	Min. Length (mm)	Motorized Adjustable Height	Standing Height	Specialty Casework
Category 0 - None		<input type="checkbox"/>	<input type="checkbox"/>	<input type="checkbox"/>
Category 1 - Low (1% - 4%)		<input type="checkbox"/>	<input type="checkbox"/>	<input type="checkbox"/>
Category 2 - Med (5% - 9%)		<input type="checkbox"/>	<input type="checkbox"/>	<input type="checkbox"/>
Category 3 - High (10% or Greater)		<input type="checkbox"/>	<input type="checkbox"/>	<input type="checkbox"/>

**MECHANICAL REQUIREMENTS**

<b>PLUMBING</b> (Quantity)		Hand Hygiene Sink: <input type="text" value="1"/> Lavatory: <input type="text"/> Kitchen Sink: <input type="text"/> Seamless Kitchen Sink: <input type="text"/> Utility / Process Sink: <input type="text"/> Scrub Sink: <input type="text"/> Floor Sink: <input type="text"/>							Other Fixtures: <input type="checkbox"/> Shower <input type="checkbox"/> Tub <input type="checkbox"/> Ice Maker <input type="checkbox"/> Water Closet <input type="checkbox"/> Instantaneous Hot Water				<input type="checkbox"/> Eyewash Station <input type="checkbox"/> Eyewash/Shower Station <input type="checkbox"/> Emergency Shower <input type="checkbox"/> Flush Rim Sink <input type="checkbox"/> Floor Drain <input type="checkbox"/> Water Bottle Refill Station				<b>MED / NON-MED GASES</b> (Quantity)					
Plumbing Remarks: <input type="text"/>		Oxygen: <input type="text"/>		Medical Air: <input type="text"/>		Medical Vacuum: <input type="text"/>		Nitrous Oxide: <input type="text"/>		CO2: <input type="text"/>		AGSS: <input type="text"/>		Nitrogen: <input type="text"/>		Laboratory Air: <input type="text"/>		Laboratory Vacuum: <input type="text"/>		Utility Compressed Air: <input type="text"/>		
		Gas Remarks: <input type="text"/>																				

**Appendix 1B Minimum Room Requirements**

Room Name:

Program Number(s):

1. P2.03.01	7.	13.	19.	25.	31.	37.	43.
2.	8.	14.	20.	26.	32.	38.	44.
3.	9.	15.	21.	27.	33.	39.	45.
4.	10.	16.	22.	28.	34.	40.	46.
5.	11.	17.	23.	29.	35.	41.	47.
6.	12.	18.	24.	30.	36.	42.	48.

**ARCHITECTURAL REQUIREMENTS**

<b>WALL AND CEILING</b> Wall Material: <input type="text" value="MMRGB"/> Finish: <input type="text" value="HPC"/> Ceiling Material: <input type="text" value="MMRGB"/> Finish: <input type="text" value="HPC"/>	<b>WALL PROTECTION</b> Type: <input type="text" value="ESRP"/> <input checked="" type="checkbox"/> Corner Guards <input type="checkbox"/> Hand Rails <input type="checkbox"/> Bed Bumper / Locator Height: <input type="text" value="2185 mm"/> <input checked="" type="checkbox"/> Crash Rails <input type="checkbox"/> Chair Rail	<b>GLAZING</b> <input type="checkbox"/> Interior Glazing	<b>FLOORING TYPES</b> Material: <input type="text" value="WSVF"/> Base: <input type="text" value="FCB"/>	<b>ROOM ACCESSORIES</b> <input type="checkbox"/> Coat Hooks <input type="checkbox"/> Ceiling Lift <input checked="" type="checkbox"/> Magnetic Whiteboard <input type="checkbox"/> Mirror <input type="checkbox"/> Infant Change Table <input type="checkbox"/> Privacy Curtain
--	---	---	---	---

- LEGEND:**
- WALL AND CEILING LEGEND:**
- AC Architectural Ceiling
  - ACT Acoustic Ceiling Tile
  - ACT-C Cleanroom
  - ARGB Abuse-Resistant Gypsum Board
  - GB Gypsum Board
  - IRGB Impact-Resistant Gypsum Board
  - KLCT Kitchen Lay-in Ceiling Tile
  - MMRGB Moisture and Mould-Resistant Gypsum Board
  - SACT Security Acoustic Ceiling Tile
- WALL FINISHES LEGEND:**
- EWC Epoxy Wall Coating
  - HPC High Performance Coating
  - PT Paint
- CEILING FINISHES LEGEND:**
- ECC Epoxy Ceiling Coating
  - HPC High Performance Coating
  - PF Prefinished
  - PT Paint
- WALL PROTECTION LEGEND:**
- ESRP Extruded Semi-Rigid PVCu Panel
  - FRL Fibre Reinforced Laminate
  - FRP Fibreglass Reinforced Plastic
  - PVV Protective Vinyl Wallcovering
  - RHIS Rigid High Impact Sheet
  - WSSP Wetwall Solid Surface Panel
  - WVV Wetroom Vinyl Wallcovering
- FLOOR FINISHES LEGEND:**
- CFS Concrete Floor Sealer
  - EFC Epoxy Floor Coating
  - PFC Polyurethane Floor Coating
  - RAF Rubber Athletic Flooring
  - RSF Rubber Sheet Flooring
  - SCF Seamless Cushioned Flooring
  - SDRF Static-Dissipative Rubber Sheet Flooring
  - SDVF Static-Dissipative Vinyl Sheet Flooring
  - VSF Vinyl Sheet Flooring
  - WSVF Wetroom Safety Vinyl Sheet Flooring
- FLOOR BASE LEGEND:**
- FCB Flash Cove Base
  - RB Rubber Base
  - SCF Seamless Cushioned Flooring

**DOORS**

Types:

Type:Qty:	Size (mm):	Material:	Finish:	Side Lt:	Blinds:	Protect.:	Privacy Film:	Function:	Card Reader:	Mag Lock:	Auto Opener:	Hold Open:	Hinges:	Accessory 1:	Accessory 2:	Accessory 3:	Closer:

Door Remarks:  Security Grille  Anti-barricade strategy

**MILLWORK AND SPECIALTY CASEWORK**

Storage Requirements:

**UPPER UNITS** (U1-U8) **SHELF** (S1)

**LOWER UNITS** (L1-L12) **RECEPTION/TRANSACTION COUNTER / CARE TEAM STATION DESK** (TC1-TC2) **UTILITY SINK AND COUNTER UNIT** (UC1)

**FULL-HEIGHT CABINETS** (C1-C5)

**Legend:**

Category	Min. Length (mm)	Motorized Adjustable Height	Standing Height	Specialty Casework
Category 0 - None				
Category 1 - Low (1% - 4%)				
Category 2 - Med (5% - 9%)				
Category 3 - High (10% or Greater)				

**FINISHES**

Full-height Cabinet:   
 Upper Millwork:   
 Countertop:   
 Lower Millwork:   
 Shelf:

Remarks:

**MECHANICAL REQUIREMENTS**

**PLUMBING** (Quantity)

Hand Hygiene Sink:	Lavatory:	Kitchen Sink:	Seamless Kitchen Sink:	Utility / Process Sink:	Scrub Sink:	Floor Sink:

Plumbing Remarks:

**Other Fixtures:**

- Shower
- Tub
- Ice Maker
- Water Closet
- Instantaneous Hot Water
- Eyewash Station
- Eyewash/Shower Station
- Emergency Shower
- Flush Rim Sink
- Floor Drain
- Water Bottle Refill Station

Other:

**MED / NON-MED GASES** (Quantity)

Oxygen:	Medical Air:	Medical Vacuum:	Nitrous Oxide:	CO2:	AGSS:	Nitrogen:	Laboratory Air:	Laboratory Vacuum:	Utility Compressed Air:
									1

Gas Remarks:

**Appendix 1B Minimum Room Requirements**

Room Name:

Program Number(s):

1. P1.05	7.	13.	19.	25.	31.	37.	43.
2.	8.	14.	20.	26.	32.	38.	44.
3.	9.	15.	21.	27.	33.	39.	45.
4.	10.	16.	22.	28.	34.	40.	46.
5.	11.	17.	23.	29.	35.	41.	47.
6.	12.	18.	24.	30.	36.	42.	48.

**ARCHITECTURAL REQUIREMENTS**

<b>WALL AND CEILING</b> Wall Material: <input type="text" value="MMRGB"/> Finish: <input type="text" value="HPC"/> Ceiling Material: <input type="text" value="MMRGB"/> Finish: <input type="text" value="HPC"/>	<b>WALL PROTECTION</b> Type: <input type="text" value="ESRP"/> <input type="checkbox"/> Corner Guards <input type="checkbox"/> Hand Rails <input type="checkbox"/> Bed Bumper / Locator Height: <input type="text" value="2185 mm"/> <input type="checkbox"/> Crash Rails <input type="checkbox"/> Chair Rail	<b>GLAZING</b> <input type="checkbox"/> Interior Glazing	<b>FLOORING TYPES</b> Material: <input type="text" value="WSVF"/> Base: <input type="text" value="FCB"/>	<b>ROOM ACCESSORIES</b> <input type="checkbox"/> Coat Hooks <input type="checkbox"/> Ceiling Lift <input type="checkbox"/> Magnetic Whiteboard <input type="checkbox"/> Mirror <input type="checkbox"/> Infant Change Table <input type="checkbox"/> Privacy Curtain
--	---	---	---	--

- LEGEND:**
- WALL AND CEILING LEGEND:**
- AC Architectural Ceiling
  - ACT Acoustic Ceiling Tile
  - ACT-C Cleanroom
  - ARGB Abuse-Resistant Gypsum Board
  - GB Gypsum Board
  - IRGB Impact-Resistant Gypsum Board
  - KLCT Kitchen Lay-in Ceiling Tile
  - MMRGB Moisture and Mould-Resistant Gypsum Board
  - SACT Security Acoustic Ceiling Tile
- WALL FINISHES LEGEND:**
- EWC Epoxy Wall Coating
  - HPC High Performance Coating
  - PT Paint
- CEILING FINISHES LEGEND:**
- ECC Epoxy Ceiling Coating
  - HPC High Performance Coating
  - PF Prefinished
  - PT Paint
- WALL PROTECTION LEGEND:**
- ESRP Extruded Semi-Rigid PVCu Panel
  - FRL Fibre Reinforced Laminate
  - FRP Fibreglass Reinforced Plastic
  - PVV Protective Vinyl Wallcovering
  - RHIS Rigid High Impact Sheet
  - WSSP Wetwall Solid Surface Panel
  - WVV Wetroom Vinyl Wallcovering
- FLOOR FINISHES LEGEND:**
- CFS Concrete Floor Sealer
  - EFC Epoxy Floor Coating
  - PFC Polyurethane Floor Coating
  - RAF Rubber Athletic Flooring
  - RSF Rubber Sheet Flooring
  - SCF Seamless Cushioned Flooring
  - SDRF Static-Dissipative Rubber Sheet Flooring
  - SDVF Static-Dissipative Vinyl Sheet Flooring
  - VSF Vinyl Sheet Flooring
  - WSVF Wetroom Safety Vinyl Sheet Flooring
- FLOOR BASE LEGEND:**
- FCB Flash Cove Base
  - RB Rubber Base
  - SCF Seamless Cushioned Flooring

**DOORS**

Types:

Type	Qty	Size (mm)	Material	Finish	Side Lt.	Blinds	Protect.	Privacy Film	Function	Card Reader	Mag Lock	Auto Opener	Hold Open	Hinges	Accessory 1	Accessory 2	Accessory 3	Closer

Door Remarks:  Security Grille  Anti-barricade strategy

**MILLWORK AND SPECIALTY CASEWORK**

Storage Requirements:

**UPPER UNITS** (U1-U8) **SHELF** (S1)

**LOWER UNITS** (L1-L12) **RECEPTION/TRANSACTION COUNTER / CARE TEAM STATION DESK** (TC1, TC2) **UTILITY SINK AND COUNTER UNIT** (UC1)

**FULL-HEIGHT CABINETS** (C1-C5)

**Legend:**

Category	Min. Length (mm)	Motorized Adjustable Height	Standing Height	Specialty Casework
Category 0 - None				
Category 1 - Low (1% - 4%)				
Category 2 - Med (5% - 9%)				
Category 3 - High (10% or Greater)				

**FINISHES**

Full-height Cabinet:   
 Upper Millwork:   
 Countertop:   
 Lower Millwork:   
 Shelf:

Remarks:

**MECHANICAL REQUIREMENTS**

**PLUMBING**

Hand Hygiene Sink:	Seamless Lavatory:	Utility / Kitchen Sink:	Process Sink:	Scrub Sink:	Floor Sink:
<input type="text"/>	<input type="text"/>	<input type="text"/>	<input type="text"/>	<input type="text"/>	<input type="text"/>

Plumbing Remarks:

**Other Fixtures:**

- Shower
- Tub
- Ice Maker
- Water Closet
- Instantaneous Hot Water
- Eyewash Station
- Eyewash/Shower Station
- Emergency Shower
- Flush Rim Sink
- Floor Drain
- Water Bottle Refill Station

Other:

**MED / NON-MED GASES**

Oxygen:	Medical Air:	Medical Vacuum:	Nitrous Oxide:	CO2:	AGSS:	Nitrogen:	Laboratory Air:	Laboratory Vacuum:	Utility Compressed Air:
<input type="text"/>	<input type="text"/>	<input type="text"/>	<input type="text"/>	<input type="text"/>	<input type="text"/>	<input type="text"/>	<input type="text"/>	<input type="text"/>	<input type="text" value="1"/>

Gas Remarks:



**Appendix 1B Minimum Room Requirements**

Room Name:

Program Number(s):

1.	P3.02.03	7.		13.		19.		25.		31.		37.		43.
2.		8.		14.		20.		26.		32.		38.		44.
3.		9.		15.		21.		27.		33.		39.		45.
4.		10.		16.		22.		28.		34.		40.		46.
5.		11.		17.		23.		29.		35.		41.		47.
6.		12.		18.		24.		30.		36.		42.		48.

**ARCHITECTURAL REQUIREMENTS**

<b>WALL AND CEILING</b> Wall Material: <input type="text" value="MMRGB"/> Finish: <input type="text" value="HPC"/> Ceiling Material: <input type="text" value="MMRGB"/> Finish: <input type="text" value="HPC"/>	<b>WALL PROTECTION</b> Type: <input type="text" value="ESRP"/> <input checked="" type="checkbox"/> Corner Guards <input type="checkbox"/> Hand Rails <input type="checkbox"/> Bed Bumper / Locator Height: <input type="text" value="2185 mm"/> <input checked="" type="checkbox"/> Crash Rails <input type="checkbox"/> Chair Rail	<b>GLAZING</b> <input type="checkbox"/> Interior Glazing	<b>FLOORING TYPES</b> Material: <input type="text" value="WSVF"/> Base: <input type="text" value="FCB"/>	<b>ROOM ACCESSORIES</b> <input type="checkbox"/> Coat Hooks <input type="checkbox"/> Ceiling Lift <input checked="" type="checkbox"/> Magnetic Whiteboard <input type="checkbox"/> Mirror <input type="checkbox"/> Infant Change Table <input type="checkbox"/> Privacy Curtain
--	---	---	---	---

- LEGEND:**
- WALL AND CEILING LEGEND:**
- AC Architectural Ceiling
  - ACT Acoustic Ceiling Tile
  - ACT-C Cleanroom
  - ARGB Abuse-Resistant Gypsum Board
  - GB Gypsum Board
  - IRGB Impact-Resistant Gypsum Board
  - KLCT Kitchen Lay-in Ceiling Tile
  - MMRGB Moisture and Mould-Resistant Gypsum Board
  - SACT Security Acoustic Ceiling Tile
- WALL FINISHES LEGEND:**
- EWC Epoxy Wall Coating
  - HPC High Performance Coating
  - PT Paint
- CEILING FINISHES LEGEND:**
- ECC Epoxy Ceiling Coating
  - HPC High Performance Coating
  - PF Prefinished
  - PT Paint
- WALL PROTECTION LEGEND:**
- ESRP Extruded Semi-Rigid PVCu Panel
  - FRL Fibre Reinforced Laminate
  - FRP Fibreglass Reinforced Plastic
  - PVV Protective Vinyl Wallcovering
  - RHIS Rigid High Impact Sheet
  - WSSP Wetwall Solid Surface Panel
  - WVV Wetroom Vinyl Wallcovering
- FLOOR FINISHES LEGEND:**
- CFS Concrete Floor Sealer
  - EFC Epoxy Floor Coating
  - PFC Polyurethane Floor Coating
  - RAF Rubber Athletic Flooring
  - RSF Rubber Sheet Flooring
  - SCF Seamless Cushioned Flooring
  - SDRF Static-Dissipative Rubber Sheet Flooring
  - SDVF Static-Dissipative Vinyl Sheet Flooring
  - VSF Vinyl Sheet Flooring
  - WSVF Wetroom Safety Vinyl Sheet Flooring
- FLOOR BASE LEGEND:**
- FCB Flash Cove Base
  - RB Rubber Base
  - SCF Seamless Cushioned Flooring

**DOORS**

Types:

Type	Qty	Size (mm)	Material	Finish	Side Lt.	Blinds	Protect.	Privacy Film	Function	Card Reader	Mag Lock	Auto Opener	Hold Open	Hinges	Accessory 1	Accessory 2	Accessory 3	Closer
G	1	1220 x 2135	Aluminum	Prefinished	<input type="checkbox"/>	<input type="checkbox"/>		<input checked="" type="checkbox"/>		<input type="checkbox"/>	<input type="checkbox"/>	<input type="checkbox"/>	<input type="checkbox"/>					

Door Remarks:  Security Grille  Anti-barricade strategy



**MECHANICAL REQUIREMENTS**

<b>PLUMBING</b> (Quantity) Hand Hygiene Sink: <input type="text"/> Lavatory: <input type="text"/> Kitchen Sink: <input type="text"/> Seamless Kitchen Sink: <input type="text"/> Utility / Process Sink: <input type="text"/> Scrub Sink: <input type="text"/> Floor Sink: <input type="text"/> Plumbing Remarks: <input type="text"/>	Other Fixtures: <input type="checkbox"/> Shower <input type="checkbox"/> Eyewash Station <input type="checkbox"/> Tub <input type="checkbox"/> Eyewash/Shower Station <input type="checkbox"/> Ice Maker <input type="checkbox"/> Emergency Shower <input type="checkbox"/> Water Closet <input type="checkbox"/> Flush Rim Sink <input type="checkbox"/> Instantaneous Hot Water <input type="checkbox"/> Floor Drain <input type="checkbox"/> <input type="checkbox"/> Water Bottle Refill Station Other: <input type="text"/>	<b>MED / NON-MED GASES</b> (Quantity) Oxygen: <input type="text"/> Medical Air: <input type="text"/> Medical Vacuum: <input type="text"/> Nitrous Oxide: <input type="text"/> CO2: <input type="text"/> AGSS: <input type="text"/> Nitrogen: <input type="text"/> Laboratory Air: <input type="text"/> Laboratory Vacuum: <input type="text"/> Utility Compressed Air: <input type="text"/> Gas Remarks: <input type="text"/>
---	---	--

**Appendix 1B Minimum Room Requirements**

Room Name:

Program Number(s):

1. P3.02.02	7.	13.	19.	25.	31.	37.	43.
2.	8.	14.	20.	26.	32.	38.	44.
3.	9.	15.	21.	27.	33.	39.	45.
4.	10.	16.	22.	28.	34.	40.	46.
5.	11.	17.	23.	29.	35.	41.	47.
6.	12.	18.	24.	30.	36.	42.	48.

**ARCHITECTURAL REQUIREMENTS**

<b>WALL AND CEILING</b> Wall Material: <input type="text" value="MMRGB"/> Finish: <input type="text" value="HPC"/> Ceiling Material: <input type="text" value="MMRGB"/> Finish: <input type="text" value="HPC"/>	<b>WALL PROTECTION</b> Type: <input type="text" value="ESRP"/> <input checked="" type="checkbox"/> Corner Guards <input type="checkbox"/> Hand Rails <input type="checkbox"/> Bed Bumper / Locator Height: <input type="text" value="2185 mm"/> <input checked="" type="checkbox"/> Crash Rails <input type="checkbox"/> Chair Rail	<b>GLAZING</b> <input type="checkbox"/> Interior Glazing	<b>FLOORING TYPES</b> Material: <input type="text" value="WSVF"/> Base: <input type="text" value="FCB"/>	<b>ROOM ACCESSORIES</b> <input type="checkbox"/> Coat Hooks <input type="checkbox"/> Ceiling Lift <input checked="" type="checkbox"/> Magnetic Whiteboard <input type="checkbox"/> Mirror <input type="checkbox"/> Infant Change Table <input type="checkbox"/> Privacy Curtain
--	---	---	---	---

- LEGEND:**
- WALL AND CEILING LEGEND:**
- AC Architectural Ceiling
  - ACT Acoustic Ceiling Tile
  - ACT-C Cleanroom
  - ARGB Abuse-Resistant Gypsum Board
  - GB Gypsum Board
  - IRGB Impact-Resistant Gypsum Board
  - KLCT Kitchen Lay-in Ceiling Tile
  - MMRGB Moisture and Mould-Resistant Gypsum Board
  - SACT Security Acoustic Ceiling Tile
- WALL FINISHES LEGEND:**
- EWC Epoxy Wall Coating
  - HPC High Performance Coating
  - PT Paint
- CEILING FINISHES LEGEND:**
- ECC Epoxy Ceiling Coating
  - HPC High Performance Coating
  - PF Prefinished
  - PT Paint
- WALL PROTECTION LEGEND:**
- ESRP Extruded Semi-Rigid PVCu Panel
  - FRL Fibre Reinforced Laminate
  - FRP Fibreglass Reinforced Plastic
  - PVV Protective Vinyl Wallcovering
  - RHIS Rigid High Impact Sheet
  - WSSP Wetwall Solid Surface Panel
  - WVV Wetroom Vinyl Wallcovering
- FLOOR FINISHES LEGEND:**
- CFS Concrete Floor Sealer
  - EFC Epoxy Floor Coating
  - PFC Polyurethane Floor Coating
  - RAF Rubber Athletic Flooring
  - RSF Rubber Sheet Flooring
  - SCF Seamless Cushioned Flooring
  - SDRF Static-Dissipative Rubber Sheet Flooring
  - SDVF Static-Dissipative Vinyl Sheet Flooring
  - VSF Vinyl Sheet Flooring
  - WSVF Wetroom Safety Vinyl Sheet Flooring
- FLOOR BASE LEGEND:**
- FCB Flash Cove Base
  - RB Rubber Base
  - SCF Seamless Cushioned Flooring

**DOORS**

Types:

Type	Qty	Size (mm)	Material	Finish	Side Lt.	Blinds	Protect.	Privacy Film	Function	Card Reader	Mag Lock	Auto Opener	Hold Open	Hinges	Accessory 1	Accessory 2	Accessory 3	Closer

Door Remarks:  Security Grille  Anti-barricade strategy

**MILLWORK AND SPECIALTY CASEWORK**

Storage Requirements:

**UPPER UNITS** (U1-U8) **SHELF** (S1)

**FULL-HEIGHT CABINETS** (C1-C5) **LOWER UNITS** (L1-L12) **RECEPTION/TRANSACTION COUNTER / CARE TEAM STATION DESK** (TC1-TC2) **UTILITY SINK AND COUNTER UNIT** (UC1)

**Legend:**

Category	Min. Length (mm)	Motorized Adjustable Height	Standing Height	Specialty Casework
Category 0 - None				
Category 1 - Low (1% - 4%)				
Category 2 - Med (5% - 9%)				
Category 3 - High (10% or Greater)				

**FINISHES**

Full-height Cabinet:   
 Upper Millwork:   
 Countertop:   
 Lower Millwork:   
 Shelf:

Remarks:

**MECHANICAL REQUIREMENTS**

**PLUMBING** (Quantity)

Hand Hygiene Sink:	Lavatory:	Kitchen Sink:	Seamless Kitchen Sink:	Utility / Process Sink:	Scrub Sink:	Floor Sink:
<input type="text"/>	<input type="text"/>	<input type="text"/>	<input type="text"/>	<input type="text"/>	<input type="text"/>	<input type="text"/>

Plumbing Remarks:

**Other Fixtures:**

- Shower
- Tub
- Ice Maker
- Water Closet
- Instantaneous Hot Water
- Eyewash Station
- Eyewash/Shower Station
- Emergency Shower
- Flush Rim Sink
- Floor Drain
- Water Bottle Refill Station

Other:

**MED / NON-MED GASES** (Quantity)

Oxygen:	Medical Air:	Medical Vacuum:	Nitrous Oxide:	CO2:	AGSS:	Nitrogen:	Laboratory Air:	Laboratory Vacuum:	Utility Compressed Air:
<input type="text"/>	<input type="text"/>	<input type="text"/>	<input type="text"/>	<input type="text"/>	<input type="text"/>	<input type="text"/>	<input type="text"/>	<input type="text"/>	<input type="text"/>

Gas Remarks:

**Appendix 1B Minimum Room Requirements**

Room Name:

Program Number(s):

1. P3.01	7.	13.	19.	25.	31.	37.	43.
2.	8.	14.	20.	26.	32.	38.	44.
3.	9.	15.	21.	27.	33.	39.	45.
4.	10.	16.	22.	28.	34.	40.	46.
5.	11.	17.	23.	29.	35.	41.	47.
6.	12.	18.	24.	30.	36.	42.	48.

**ARCHITECTURAL REQUIREMENTS**

<b>WALL AND CEILING</b> Wall Material: <input type="text" value="ARGB 1.2m AFF, GB above"/> Finish: <input type="text" value="HPC"/> Ceiling Material: <input type="text" value="MMRGB"/> Finish: <input type="text" value="HPC"/>		<b>WALL PROTECTION</b> Type: <input type="text" value="ESRP"/> <input checked="" type="checkbox"/> Corner Guards <input type="checkbox"/> Hand Rails <input type="checkbox"/> Bed Bumper / Locator Height: <input type="text" value="2185 mm"/> <input checked="" type="checkbox"/> Crash Rails <input type="checkbox"/> Chair Rail		<b>GLAZING</b> <input type="checkbox"/> Interior Glazing		<b>FLOORING TYPES</b> Material: <input type="text" value="WSVF"/> Base: <input type="text" value="FCB"/>		<b>ROOM ACCESSORIES</b> <input type="checkbox"/> Coat Hooks <input type="checkbox"/> Ceiling Lift <input type="checkbox"/> Magnetic Whiteboard <input type="checkbox"/> Mirror <input type="checkbox"/> Infant Change Table <input type="checkbox"/> Privacy Curtain	
--	--	---	--	---	--	---	--	--	--

- LEGEND:**
- WALL AND CEILING LEGEND:**
- AC Architectural Ceiling
  - ACT Acoustic Ceiling Tile
  - ACT-C Cleanroom
  - ARGB Abuse-Resistant Gypsum Board
  - GB Gypsum Board
  - IRGB Impact-Resistant Gypsum Board
  - KLCT Kitchen Lay-in Ceiling Tile
  - MMRGB Moisture and Mould-Resistant Gypsum Board
  - SACT Security Acoustic Ceiling Tile
- WALL FINISHES LEGEND:**
- EWC Epoxy Wall Coating
  - HPC High Performance Coating
  - PT Paint
- CEILING FINISHES LEGEND:**
- ECC Epoxy Ceiling Coating
  - HPC High Performance Coating
  - PF Prefinished
  - PT Paint
- WALL PROTECTION LEGEND:**
- ESRP Extruded Semi-Rigid PVCu Panel
  - FRL Fibre Reinforced Laminate
  - FRP Fibreglass Reinforced Plastic
  - PVV Protective Vinyl Wallcovering
  - RHIS Rigid High Impact Sheet
  - WSSP Wetwall Solid Surface Panel
  - WVV Wetroom Vinyl Wallcovering
- FLOOR FINISHES LEGEND:**
- CFS Concrete Floor Sealer
  - EFC Epoxy Floor Coating
  - PFC Polyurethane Floor Coating
  - RAF Rubber Athletic Flooring
  - RSF Rubber Sheet Flooring
  - SCF Seamless Cushioned Flooring
  - SDRF Static-Dissipative Rubber Sheet Flooring
  - SDVF Static-Dissipative Vinyl Sheet Flooring
  - VSF Vinyl Sheet Flooring
  - WSVF Wetroom Safety Vinyl Sheet Flooring
- FLOOR BASE LEGEND:**
- FCB Flash Cove Base
  - RB Rubber Base
  - SCF Seamless Cushioned Flooring

**DOORS**

Types:

Type	Qty	Size (mm)	Material	Finish	Side Lt.	Blinds	Protect.	Privacy Film	Function	Card Reader	Mag Lock	Auto Opener	Hold Open	Hinges	Accessory 1	Accessory 2	Accessory 3	Closer
G	1	1220 x 2135	Aluminum	Prefinished	<input type="checkbox"/>	<input type="checkbox"/>	<input type="checkbox"/>	<input type="checkbox"/>		<input type="checkbox"/>	<input type="checkbox"/>	<input checked="" type="checkbox"/>	<input type="checkbox"/>		Elec. Strike			

Door Remarks:

Security Grille  
 Anti-barricade strategy

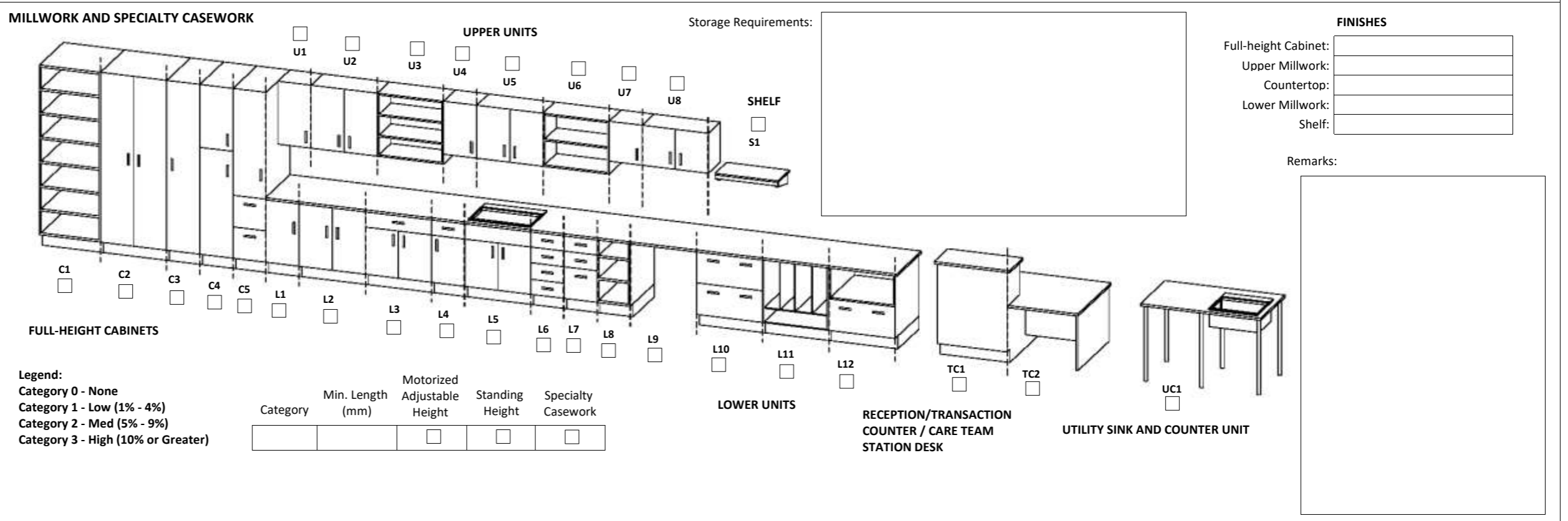

**MECHANICAL REQUIREMENTS**

<b>PLUMBING</b> (Quantity) Hand Hygiene Sink: <input type="text"/> Lavatory: <input type="text"/> Kitchen Sink: <input type="text"/> Seamless Kitchen Sink: <input type="text"/> Utility / Process Sink: <input type="text"/> Scrub Sink: <input type="text"/> Floor Sink: <input type="text"/>							Other Fixtures: <input type="checkbox"/> Shower <input type="checkbox"/> Eyewash Station <input type="checkbox"/> Tub <input type="checkbox"/> Eyewash/Shower Station <input type="checkbox"/> Ice Maker <input type="checkbox"/> Emergency Shower <input type="checkbox"/> Water Closet <input type="checkbox"/> Flush Rim Sink <input type="checkbox"/> Instantaneous Hot Water <input type="checkbox"/> Floor Drain <input type="checkbox"/> Water Bottle Refill Station Other: <input type="text"/>				<b>MED / NON-MED GASES</b> (Quantity) Oxygen: <input type="text"/> Medical Air: <input type="text"/> Medical Vacuum: <input type="text"/> Nitrous Oxide: <input type="text"/> CO2: <input type="text"/> AGSS: <input type="text"/> Nitrogen: <input type="text"/> Laboratory Air: <input type="text"/> Laboratory Vacuum: <input type="text"/> Utility Compressed Air: <input type="text" value="3"/>					
Plumbing Remarks: <input type="text"/>											Gas Remarks: <input type="text" value="Provide (1) utility compressed air per sterilizer."/>					



**Appendix 1B Minimum Room Requirements**

Room Name:

Program Number(s):

1. P1.11	7.	13.	19.	25.	31.	37.	43.
2.	8.	14.	20.	26.	32.	38.	44.
3.	9.	15.	21.	27.	33.	39.	45.
4.	10.	16.	22.	28.	34.	40.	46.
5.	11.	17.	23.	29.	35.	41.	47.
6.	12.	18.	24.	30.	36.	42.	48.

**ARCHITECTURAL REQUIREMENTS**

<b>WALL AND CEILING</b> Wall Material: <input type="text" value="ARGB 1.2m AFF, GB above"/> Finish: <input type="text" value="HPC"/> Ceiling Material: <input type="text" value="MMRGB"/> Finish: <input type="text" value="HPC"/>	<b>WALL PROTECTION</b> Type: <input type="text" value="ESRP"/> <input checked="" type="checkbox"/> Corner Guards <input type="checkbox"/> Hand Rails <input type="checkbox"/> Bed Bumper / Locator Height: <input type="text" value="2185 mm"/> <input type="checkbox"/> Crash Rails <input type="checkbox"/> Chair Rail	<b>GLAZING</b> <input type="checkbox"/> Interior Glazing	<b>FLOORING TYPES</b> Material: <input type="text" value="WSVF"/> Base: <input type="text" value="FCB"/>	<b>ROOM ACCESSORIES</b> <input type="checkbox"/> Coat Hooks <input type="checkbox"/> Ceiling Lift <input type="checkbox"/> Magnetic Whiteboard <input type="checkbox"/> Mirror <input type="checkbox"/> Infant Change Table <input type="checkbox"/> Privacy Curtain
--	--	---	---	--

- LEGEND:**
- WALL AND CEILING LEGEND:**
- AC Architectural Ceiling
  - ACT Acoustic Ceiling Tile
  - ACT-C Cleanroom
  - ARGB Abuse-Resistant Gypsum Board
  - GB Gypsum Board
  - IRGB Impact-Resistant Gypsum Board
  - KLCT Kitchen Lay-in Ceiling Tile
  - MMRGB Moisture and Mould-Resistant Gypsum Board
  - SACT Security Acoustic Ceiling Tile
- WALL FINISHES LEGEND:**
- EWC Epoxy Wall Coating
  - HPC High Performance Coating
  - PT Paint
- CEILING FINISHES LEGEND:**
- ECC Epoxy Ceiling Coating
  - HPC High Performance Coating
  - PF Prefinished
  - PT Paint
- WALL PROTECTION LEGEND:**
- ESRP Extruded Semi-Rigid PVCu Panel
  - FRL Fibre Reinforced Laminate
  - FRP Fibreglass Reinforced Plastic
  - PVV Protective Vinyl Wallcovering
  - RHIS Rigid High Impact Sheet
  - WSSP Wetwall Solid Surface Panel
  - WVV Wetroom Vinyl Wallcovering
- FLOOR FINISHES LEGEND:**
- CFS Concrete Floor Sealer
  - EFC Epoxy Floor Coating
  - PFC Polyurethane Floor Coating
  - RAF Rubber Athletic Flooring
  - RSF Rubber Sheet Flooring
  - SCF Seamless Cushioned Flooring
  - SDRF Static-Dissipative Rubber Sheet Flooring
  - SDVF Static-Dissipative Vinyl Sheet Flooring
  - VSF Vinyl Sheet Flooring
  - WSVF Wetroom Safety Vinyl Sheet Flooring
- FLOOR BASE LEGEND:**
- FCB Flash Cove Base
  - RB Rubber Base
  - SCF Seamless Cushioned Flooring

**DOORS**

Types:

Type	Qty	Size (mm)	Material	Finish	Side Lt.	Blinds	Protect.	Privacy Film	Function	Card Reader	Mag Lock	Auto Opener	Hold Open	Hinges	Accessory 1	Accessory 2	Accessory 3	Closer
C	1	1220 x 2135	Hollow Metal	Paint	<input type="checkbox"/>	<input type="checkbox"/>	2 High	<input type="checkbox"/>	Storeroom	<input checked="" type="checkbox"/>	<input type="checkbox"/>	<input type="checkbox"/>	<input checked="" type="checkbox"/>	Cont. Swing Clear				Surface

Door Remarks:  Security Grille  Anti-barricade strategy



**MECHANICAL REQUIREMENTS**

<b>PLUMBING</b> (Quantity) Hand Hygiene Sink: <input type="text"/> Lavatory: <input type="text"/> Kitchen Sink: <input type="text"/> Seamless Kitchen Sink: <input type="text"/> Utility / Process Sink: <input type="text"/> Scrub Sink: <input type="text"/> Floor Sink: <input type="text"/> Plumbing Remarks: <input type="text"/>	Other Fixtures: <input type="checkbox"/> Shower <input type="checkbox"/> Eyewash Station <input type="checkbox"/> Tub <input type="checkbox"/> Eyewash/Shower Station <input type="checkbox"/> Ice Maker <input type="checkbox"/> Emergency Shower <input type="checkbox"/> Water Closet <input checked="" type="checkbox"/> Floor Drain <input type="checkbox"/> Instantaneous Hot Water <input type="checkbox"/> Water Bottle Refill Station Other: <input type="text"/>	<b>MED / NON-MED GASES</b> (Quantity) Oxygen: <input type="text"/> Medical Air: <input type="text"/> Medical Vacuum: <input type="text"/> Nitrous Oxide: <input type="text"/> CO2: <input type="text"/> AGSS: <input type="text"/> Nitrogen: <input type="text"/> Laboratory Air: <input type="text"/> Laboratory Vacuum: <input type="text"/> Utility Compressed Air: <input type="text"/> Gas Remarks: <input type="text"/>
---	--	---

# Appendix 1B Minimum Room Requirements

Room Name:

Program Number(s):

1.	P3.03	7.		13.		19.		25.		31.		37.		43.
2.		8.		14.		20.		26.		32.		38.		44.
3.		9.		15.		21.		27.		33.		39.		45.
4.		10.		16.		22.		28.		34.		40.		46.
5.		11.		17.		23.		29.		35.		41.		47.
6.		12.		18.		24.		30.		36.		42.		48.

## ARCHITECTURAL REQUIREMENTS

<b>WALL AND CEILING</b> Wall Material: <input type="text" value="ARGB 1.2m AFF, GB above"/> Finish: <input type="text" value="HPC"/> Ceiling Material: <input type="text" value="MMRGB"/> Finish: <input type="text" value="HPC"/>		<b>WALL PROTECTION</b> Type: <input type="text" value="ESRP"/> <input checked="" type="checkbox"/> Corner Guards <input type="checkbox"/> Hand Rails <input type="checkbox"/> Bed Bumper / Locator Height: <input type="text" value="2185 mm"/> <input checked="" type="checkbox"/> Crash Rails <input type="checkbox"/> Chair Rail			<b>GLAZING</b> <input checked="" type="checkbox"/> Interior Glazing		<b>FLOORING TYPES</b> Material: <input type="text" value="WSVF"/> Base: <input type="text" value="FCB"/>		<b>ROOM ACCESSORIES</b> <input type="checkbox"/> Coat Hooks <input type="checkbox"/> Ceiling Lift <input type="checkbox"/> Magnetic Whiteboard <input type="checkbox"/> Mirror <input type="checkbox"/> Infant Change Table <input type="checkbox"/> Privacy Curtain		
--	--	---	--	--	--	--	---	--	--	--	--

- LEGEND:**
- WALL AND CEILING LEGEND:**
- AC Architectural Ceiling
  - ACT Acoustic Ceiling Tile
  - ACT-C Cleanroom
  - ARGB Abuse-Resistant Gypsum Board
  - GB Gypsum Board
  - IRGB Impact-Resistant Gypsum Board
  - KLCT Kitchen Lay-in Ceiling Tile
  - MMRGB Moisture and Mould-Resistant Gypsum Board
  - SACT Security Acoustic Ceiling Tile
- WALL FINISHES LEGEND:**
- EWC Epoxy Wall Coating
  - HPC High Performance Coating
  - PT Paint
- CEILING FINISHES LEGEND:**
- ECC Epoxy Ceiling Coating
  - HPC High Performance Coating
  - PF Prefinished
  - PT Paint
- WALL PROTECTION LEGEND:**
- ESRP Extruded Semi-Rigid PVCu Panel
  - FRL Fibre Reinforced Laminate
  - FRP Fibreglass Reinforced Plastic
  - PVV Protective Vinyl Wallcovering
  - RHIS Rigid High Impact Sheet
  - WSSP Wetwall Solid Surface Panel
  - WVV Wetroom Vinyl Wallcovering
- FLOOR FINISHES LEGEND:**
- CFS Concrete Floor Sealer
  - EFC Epoxy Floor Coating
  - PFC Polyurethane Floor Coating
  - RAF Rubber Athletic Flooring
  - RSF Rubber Sheet Flooring
  - SCF Seamless Cushioned Flooring
  - SDRF Static-Dissipative Rubber Sheet Flooring
  - SDVF Static-Dissipative Vinyl Sheet Flooring
  - VSF Vinyl Sheet Flooring
  - WSVF Wetroom Safety Vinyl Sheet Flooring
- FLOOR BASE LEGEND:**
- FCB Flash Cove Base
  - RB Rubber Base
  - SCF Seamless Cushioned Flooring

**DOORS**

Types:

Type	Qty	Size (mm)	Material	Finish	Side Lt.	Blinds	Protect.	Privacy Film	Function	Card Reader	Mag Lock	Auto Opener	Hold Open	Hinges	Accessory 1	Accessory 2	Accessory 3	Closer
C	2	1065 x 2135	Hollow Metal	Paint	<input type="checkbox"/>	<input type="checkbox"/>		<input type="checkbox"/>	Storeroom	<input checked="" type="checkbox"/>	<input type="checkbox"/>	<input type="checkbox"/>	<input checked="" type="checkbox"/>	Butt Hinge				Surface

**DOOR REMARKS:**

Security Grille  
 Anti-barricade strategy

**MILLWORK AND SPECIALTY CASEWORK**

**UPPER UNITS:** U1, U2, U3, U4, U5, U6, U7, U8

**LOWER UNITS:** L1, L2, L3, L4, L5, L6, L7, L8, L9, L10, L11, L12

**RECEPTION/TRANSACTION COUNTER / CARE TEAM STATION DESK:** TC1, TC2

**UTILITY SINK AND COUNTER UNIT:** UC1

**SHELF:** S1

**Storage Requirements:**

**FINISHES**

Full-height Cabinet:   
 Upper Millwork:   
 Countertop:   
 Lower Millwork:   
 Shelf:

**Remarks:**

## MECHANICAL REQUIREMENTS

<b>PLUMBING</b> (Quantity) Hand Hygiene Sink: <input type="text"/> Lavatory: <input type="text"/> Kitchen Sink: <input type="text"/> Seamless Kitchen Sink: <input type="text"/> Utility / Process Sink: <input type="text"/> Scrub Sink: <input type="text"/> Floor Sink: <input type="text"/>							<b>Other Fixtures:</b> <input type="checkbox"/> Shower <input type="checkbox"/> Tub <input type="checkbox"/> Ice Maker <input type="checkbox"/> Water Closet <input type="checkbox"/> Instantaneous Hot Water <input type="checkbox"/> Eyewash Station <input type="checkbox"/> Eyewash/Shower Station <input type="checkbox"/> Emergency Shower <input type="checkbox"/> Flush Rim Sink <input type="checkbox"/> Floor Drain <input type="checkbox"/> Water Bottle Refill Station Other: <input type="text"/>				<b>MED / NON-MED GASES</b> (Quantity) Oxygen: <input type="text"/> Medical Air: <input type="text"/> Medical Vacuum: <input type="text"/> Nitrous Oxide: <input type="text"/> CO2: <input type="text"/> AGSS: <input type="text"/> Nitrogen: <input type="text"/> Laboratory Air: <input type="text"/> Laboratory Vacuum: <input type="text"/> Utility Compressed Air: <input type="text"/>					
Plumbing Remarks: <input type="text"/>											Gas Remarks: <input type="text"/>					

**Appendix 1B Minimum Room Requirements**

Room Name:

Program Number(s):

1. P2.03.02	7.	13.	19.	25.	31.	37.	43.
2.	8.	14.	20.	26.	32.	38.	44.
3.	9.	15.	21.	27.	33.	39.	45.
4.	10.	16.	22.	28.	34.	40.	46.
5.	11.	17.	23.	29.	35.	41.	47.
6.	12.	18.	24.	30.	36.	42.	48.

**ARCHITECTURAL REQUIREMENTS**

<b>WALL AND CEILING</b> Wall Material: <input type="text" value="ARGB 1.2m AFF, GB above"/> Finish: <input type="text" value="HPC"/> Ceiling Material: <input type="text" value="MMRGB"/> Finish: <input type="text" value="HPC"/>	<b>WALL PROTECTION</b> Type: <input type="text" value="ESRP"/> <input type="checkbox"/> Corner Guards <input type="checkbox"/> Hand Rails <input type="checkbox"/> Bed Bumper / Locator Height: <input type="text" value="2185 mm"/> <input type="checkbox"/> Crash Rails <input type="checkbox"/> Chair Rail	<b>GLAZING</b> <input type="checkbox"/> Interior Glazing	<b>FLOORING TYPES</b> Material: <input type="text" value="WSVF"/> Base: <input type="text" value="FCB"/>	<b>ROOM ACCESSORIES</b> <input type="checkbox"/> Coat Hooks <input type="checkbox"/> Ceiling Lift <input checked="" type="checkbox"/> Magnetic Whiteboard <input type="checkbox"/> Mirror <input type="checkbox"/> Infant Change Table <input type="checkbox"/> Privacy Curtain
--	---	---	---	---

- LEGEND:**
- WALL AND CEILING LEGEND:**
- AC Architectural Ceiling
  - ACT Acoustic Ceiling Tile
  - ACT-C Cleanroom
  - ARGB Abuse-Resistant Gypsum Board
  - GB Gypsum Board
  - IRGB Impact-Resistant Gypsum Board
  - KLCT Kitchen Lay-in Ceiling Tile
  - MMRGB Moisture and Mould-Resistant Gypsum Board
  - SACT Security Acoustic Ceiling Tile
- WALL FINISHES LEGEND:**
- EWC Epoxy Wall Coating
  - HPC High Performance Coating
  - PT Paint
- CEILING FINISHES LEGEND:**
- ECC Epoxy Ceiling Coating
  - HPC High Performance Coating
  - PF Prefinished
  - PT Paint
- WALL PROTECTION LEGEND:**
- ESRP Extruded Semi-Rigid PVCu Panel
  - FRL Fibre Reinforced Laminate
  - FRP Fibreglass Reinforced Plastic
  - PVV Protective Vinyl Wallcovering
  - RHIS Rigid High Impact Sheet
  - WSSP Wetwall Solid Surface Panel
  - WVV Wetroom Vinyl Wallcovering
- FLOOR FINISHES LEGEND:**
- CFS Concrete Floor Sealer
  - EFC Epoxy Floor Coating
  - PFC Polyurethane Floor Coating
  - RAF Rubber Athletic Flooring
  - RSF Rubber Sheet Flooring
  - SCF Seamless Cushioned Flooring
  - SDRF Static-Dissipative Rubber Sheet Flooring
  - SDVF Static-Dissipative Vinyl Sheet Flooring
  - VSF Vinyl Sheet Flooring
  - WSVF Wetroom Safety Vinyl Sheet Flooring
- FLOOR BASE LEGEND:**
- FCB Flash Cove Base
  - RB Rubber Base
  - SCF Seamless Cushioned Flooring

**DOORS**

Types:

Type:Qty:	Size (mm):	Material:	Finish:	Side Lt:	Blinds:	Protect.:	Privacy Film:	Function:	Card Reader:	Mag Lock:	Auto Opener:	Hold Open:	Hinges:	Accessory 1:	Accessory 2:	Accessory 3:	Closer:

Door Remarks:  Security Grille  Anti-barricade strategy

**MILLWORK AND SPECIALTY CASEWORK**

Storage Requirements:

**UPPER UNITS** (U1-U8) **SHELF** (S1)

**LOWER UNITS** (L1-L12) **RECEPTION/TRANSACTION COUNTER / CARE TEAM STATION DESK** (TC1, TC2) **UTILITY SINK AND COUNTER UNIT** (UC1)

**FULL-HEIGHT CABINETS** (C1-C5)

**Legend:**

Category	Min. Length (mm)	Motorized Adjustable Height	Standing Height	Specialty Casework
Category 0 - None				
Category 1 - Low (1% - 4%)				
Category 2 - Med (5% - 9%)				
Category 3 - High (10% or Greater)				

**FINISHES**

Full-height Cabinet:   
 Upper Millwork:   
 Countertop:   
 Lower Millwork:   
 Shelf:

Remarks:

**MECHANICAL REQUIREMENTS**

<b>PLUMBING</b> (Quantity) Hand Hygiene Sink: <input type="text"/> Lavatory: <input type="text"/> Kitchen Sink: <input type="text"/> Seamless Kitchen Sink: <input type="text"/> Utility / Process Sink: <input type="text"/> Scrub Sink: <input type="text"/> Floor Sink: <input type="text"/> Plumbing Remarks: <input type="text"/>	Other Fixtures: <input type="checkbox"/> Shower <input type="checkbox"/> Tub <input type="checkbox"/> Ice Maker <input type="checkbox"/> Water Closet <input type="checkbox"/> Instantaneous Hot Water <input type="checkbox"/> Eyewash Station <input type="checkbox"/> Eyewash/Shower Station <input type="checkbox"/> Emergency Shower <input type="checkbox"/> Flush Rim Sink <input type="checkbox"/> Floor Drain <input type="checkbox"/> Water Bottle Refill Station Other: <input type="text"/>	<b>MED / NON-MED GASES</b> (Quantity) Oxygen: <input type="text"/> Medical Air: <input type="text"/> Medical Vacuum: <input type="text"/> Nitrous Oxide: <input type="text"/> CO2: <input type="text"/> AGSS: <input type="text"/> Nitrogen: <input type="text"/> Laboratory Air: 15 Laboratory Vacuum: <input type="text"/> Utility Compressed Air: <input type="text"/> Gas Remarks: <input type="text" value="Provide (1) medical air for each assembly table."/>
---	--	--



**Appendix 1B Minimum Room Requirements**

Room Name:

Program Number(s):

1.	P1.03.03	7.		13.		19.		25.		31.		37.		43.
2.		8.		14.		20.		26.		32.		38.		44.
3.		9.		15.		21.		27.		33.		39.		45.
4.		10.		16.		22.		28.		34.		40.		46.
5.		11.		17.		23.		29.		35.		41.		47.
6.		12.		18.		24.		30.		36.		42.		48.

**ARCHITECTURAL REQUIREMENTS**

<b>WALL AND CEILING</b> Wall Material: <input type="text" value="ARGB 1.2m AFF, GB above"/> Finish: <input type="text" value="HPC"/> Ceiling Material: <input type="text" value="MMRGB"/> Finish: <input type="text" value="HPC"/>	<b>WALL PROTECTION</b> Type: <input type="text" value="ESRP"/> <input type="checkbox"/> Corner Guards <input type="checkbox"/> Hand Rails <input type="checkbox"/> Bed Bumper / Locator Height: <input type="text" value="2185 mm"/> <input type="checkbox"/> Crash Rails <input type="checkbox"/> Chair Rail	<b>GLAZING</b> <input type="checkbox"/> Interior Glazing	<b>FLOORING TYPES</b> Material: <input type="text" value="WSVF"/> Base: <input type="text" value="FCB"/>	<b>ROOM ACCESSORIES</b> <input type="checkbox"/> Coat Hooks <input type="checkbox"/> Ceiling Lift <input checked="" type="checkbox"/> Magnetic Whiteboard <input type="checkbox"/> Mirror <input type="checkbox"/> Infant Change Table <input type="checkbox"/> Privacy Curtain
--	---	---	---	---

- LEGEND:**
- WALL AND CEILING LEGEND:**
- AC Architectural Ceiling
  - ACT Acoustic Ceiling Tile
  - ACT-C Cleanroom
  - ARGB Abuse-Resistant Gypsum Board
  - GB Gypsum Board
  - IRGB Impact-Resistant Gypsum Board
  - KLCT Kitchen Lay-in Ceiling Tile
  - MMRGB Moisture and Mould-Resistant Gypsum Board
  - SACT Security Acoustic Ceiling Tile
- WALL FINISHES LEGEND:**
- EWC Epoxy Wall Coating
  - HPC High Performance Coating
  - PT Paint
- CEILING FINISHES LEGEND:**
- ECC Epoxy Ceiling Coating
  - HPC High Performance Coating
  - PF Prefinished
  - PT Paint
- WALL PROTECTION LEGEND:**
- ESRP Extruded Semi-Rigid PVCu Panel
  - FRL Fibre Reinforced Laminate
  - FRP Fibreglass Reinforced Plastic
  - PVV Protective Vinyl Wallcovering
  - RHIS Rigid High Impact Sheet
  - WSSP Wetwall Solid Surface Panel
  - WVV Wetroom Vinyl Wallcovering
- FLOOR FINISHES LEGEND:**
- CFS Concrete Floor Sealer
  - EFC Epoxy Floor Coating
  - PFC Polyurethane Floor Coating
  - RAF Rubber Athletic Flooring
  - RSF Rubber Sheet Flooring
  - SCF Seamless Cushioned Flooring
  - SDRF Static-Dissipative Rubber Sheet Flooring
  - SDVF Static-Dissipative Vinyl Sheet Flooring
  - VSF Vinyl Sheet Flooring
  - WSVF Wetroom Safety Vinyl Sheet Flooring
- FLOOR BASE LEGEND:**
- FCB Flash Cove Base
  - RB Rubber Base
  - SCF Seamless Cushioned Flooring

**DOORS**

Types:

Type:Qty:	Size (mm):	Material:	Finish:	Side Lt:	Blinds:	Protect.:	Privacy Film:	Function:	Card Reader:	Mag Lock:	Auto Opener:	Hold Open:	Hinges:	Accessory 1:	Accessory 2:	Accessory 3:	Closer:	

Door Remarks:  Security Grille  Anti-barricade strategy

**MILLWORK AND SPECIALTY CASEWORK**

Storage Requirements:

**UPPER UNITS** (U1-U8) **SHELF** (S1)

**LOWER UNITS** (L1-L12) **RECEPTION/TRANSACTION COUNTER / CARE TEAM STATION DESK** (TC1-TC2) **UTILITY SINK AND COUNTER UNIT** (UC1)

**FULL-HEIGHT CABINETS** (C1-C5)

**Legend:**

Category	Min. Length (mm)	Motorized Adjustable Height	Standing Height	Specialty Casework
Category 0 - None				
Category 1 - Low (1% - 4%)				
Category 2 - Med (5% - 9%)				
Category 3 - High (10% or Greater)				

**FINISHES**

Full-height Cabinet:   
 Upper Millwork:   
 Countertop:   
 Lower Millwork:   
 Shelf:

Remarks:

**MECHANICAL REQUIREMENTS**

**PLUMBING**

Hand Hygiene Sink:	Lavatory:	Kitchen Sink:	Seamless Kitchen Sink:	Utility / Process Sink:	Scrub Sink:	Floor Sink:

Plumbing Remarks:

**Other Fixtures:**

- Shower
- Tub
- Ice Maker
- Water Closet
- Instantaneous Hot Water
- Eyewash Station
- Eyewash/Shower Station
- Emergency Shower
- Flush Rim Sink
- Floor Drain
- Water Bottle Refill Station

Other:

**MED / NON-MED GASES**

Oxygen:	Medical Air:	Medical Vacuum:	Nitrous Oxide:	CO2:	AGSS:	Nitrogen:	Laboratory Air:	Laboratory Vacuum:	Utility Compressed Air:
									1

Gas Remarks:

**Appendix 1B Minimum Room Requirements**

Room Name:

Program Number(s):

1. P1.03.02	7.	13.	19.	25.	31.	37.	43.
2.	8.	14.	20.	26.	32.	38.	44.
3.	9.	15.	21.	27.	33.	39.	45.
4.	10.	16.	22.	28.	34.	40.	46.
5.	11.	17.	23.	29.	35.	41.	47.
6.	12.	18.	24.	30.	36.	42.	48.

**ARCHITECTURAL REQUIREMENTS**

<b>WALL AND CEILING</b> Wall Material: <input type="text" value="ARGB 1.2m AFF, GB above"/> Finish: <input type="text" value="HPC"/> Ceiling Material: <input type="text" value="MMRGB"/> Finish: <input type="text" value="HPC"/>		<b>WALL PROTECTION</b> Type: <input type="text" value="ESRP"/> <input type="checkbox"/> Corner Guards <input type="checkbox"/> Hand Rails <input type="checkbox"/> Bed Bumper / Locator Height: <input type="text" value="2185 mm"/> <input type="checkbox"/> Crash Rails <input type="checkbox"/> Chair Rail			<b>GLAZING</b> <input type="checkbox"/> Interior Glazing		<b>FLOORING TYPES</b> Material: <input type="text" value="WSVF"/> Base: <input type="text" value="FCB"/>		<b>ROOM ACCESSORIES</b> <input type="checkbox"/> Coat Hooks <input type="checkbox"/> Ceiling Lift <input checked="" type="checkbox"/> Magnetic Whiteboard <input type="checkbox"/> Mirror <input type="checkbox"/> Infant Change Table <input type="checkbox"/> Privacy Curtain		
--	--	---	--	--	---	--	---	--	---	--	--

- LEGEND:**
- WALL AND CEILING LEGEND:**
- AC Architectural Ceiling
  - ACT Acoustic Ceiling Tile
  - ACT-C Cleanroom
  - ARGB Abuse-Resistant Gypsum Board
  - GB Gypsum Board
  - IRGB Impact-Resistant Gypsum Board
  - KLCT Kitchen Lay-in Ceiling Tile
  - MMRGB Moisture and Mould-Resistant Gypsum Board
  - SACT Security Acoustic Ceiling Tile
- WALL FINISHES LEGEND:**
- EWC Epoxy Wall Coating
  - HPC High Performance Coating
  - PT Paint
- CEILING FINISHES LEGEND:**
- ECC Epoxy Ceiling Coating
  - HPC High Performance Coating
  - PF Prefinished
  - PT Paint
- WALL PROTECTION LEGEND:**
- ESRP Extruded Semi-Rigid PVCu Panel
  - FRL Fibre Reinforced Laminate
  - FRP Fibreglass Reinforced Plastic
  - PVV Protective Vinyl Wallcovering
  - RHIS Rigid High Impact Sheet
  - WSSP Wetwall Solid Surface Panel
  - WVV Wetroom Vinyl Wallcovering
- FLOOR FINISHES LEGEND:**
- CFS Concrete Floor Sealer
  - EFC Epoxy Floor Coating
  - PFC Polyurethane Floor Coating
  - RAF Rubber Athletic Flooring
  - RSF Rubber Sheet Flooring
  - SCF Seamless Cushioned Flooring
  - SDRF Static-Dissipative Rubber Sheet Flooring
  - SDVF Static-Dissipative Vinyl Sheet Flooring
  - VSF Vinyl Sheet Flooring
  - WSVF Wetroom Safety Vinyl Sheet Flooring
- FLOOR BASE LEGEND:**
- FCB Flash Cove Base
  - RB Rubber Base
  - SCF Seamless Cushioned Flooring

**DOORS**

Types:

Type:Qty:	Size (mm):	Material:	Finish:	Side Lt:	Blinds:	Protect.:	Privacy Film:	Function:	Card Reader:	Mag Lock:	Auto Opener:	Hold Open:	Hinges:	Accessory 1:	Accessory 2:	Accessory 3:	Closer:

Door Remarks:  Security Grille  Anti-barricade strategy

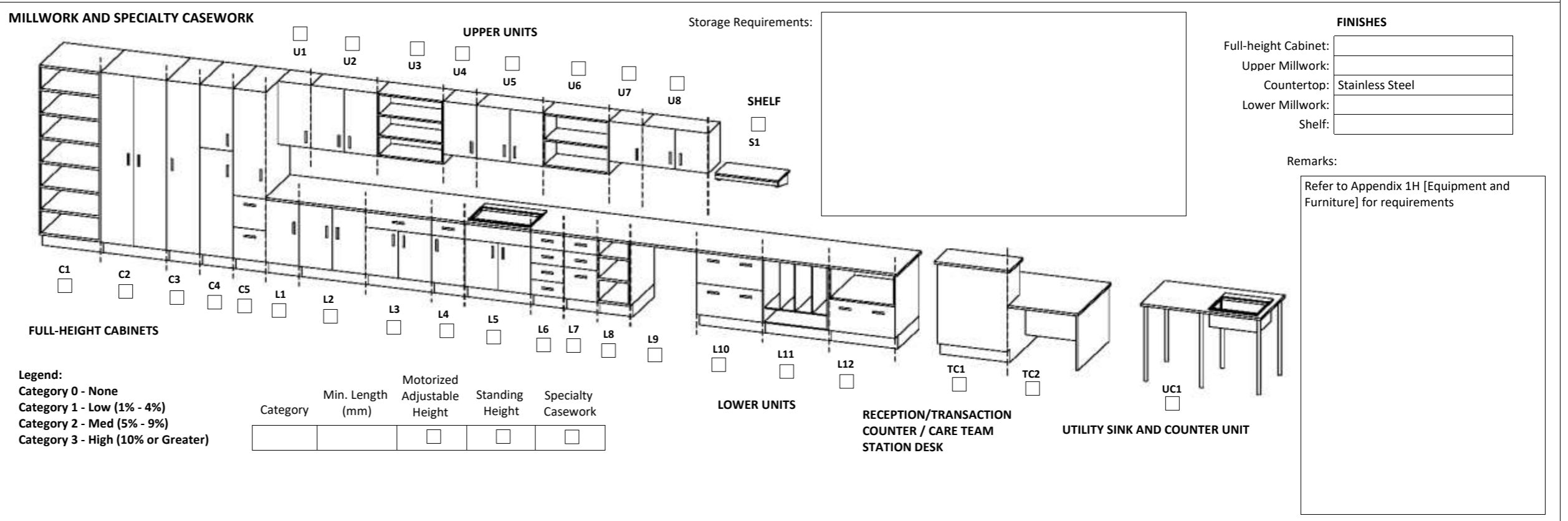

**MECHANICAL REQUIREMENTS**

<b>PLUMBING</b> (Quantity) Hygiene Sink: <input type="text"/> Lavatory: <input type="text"/> Kitchen Sink: <input type="text"/> Kitchen Sink: <input type="text"/> Utility / Process Sink: <input type="text" value="5"/> Scrub Sink: <input type="text"/> Floor Sink: <input type="text"/>							Other Fixtures: <input type="checkbox"/> Shower <input type="checkbox"/> Eyewash Station <input type="checkbox"/> Tub <input type="checkbox"/> Eyewash/Shower Station <input type="checkbox"/> Ice Maker <input type="checkbox"/> Emergency Shower <input type="checkbox"/> Water Closet <input type="checkbox"/> Flush Rim Sink <input type="checkbox"/> Instantaneous Hot Water <input type="checkbox"/> Floor Drain <input type="checkbox"/> <input type="checkbox"/> Water Bottle Refill Station Other <input type="text"/>				<b>MED / NON-MED GASES</b> (Quantity) Oxygen: <input type="text"/> Medical Air: <input type="text"/> Medical Vacuum: <input type="text"/> Nitrous Oxide: <input type="text"/> CO2: <input type="text"/> AGSS: <input type="text"/> Nitrogen: <input type="text"/> Laboratory Air: <input type="text" value="5"/> Laboratory Vacuum: <input type="text"/> Utility Compressed Air: <input type="text"/>				
Plumbing Remarks: <input type="text" value="Refer to Appendix 1H [Equipment and Furniture] for reprocessing sink types"/>							Gas Remarks: <input type="text" value="Provide (1) medical air per sink. Ventilation needed at each sink, sinks will need a feed from the detergent dispensing room"/>								

**Appendix 1B Minimum Room Requirements**

Room Name:

Program Number(s):

1. P2.03.05	7.	13.	19.	25.	31.	37.	43.
2.	8.	14.	20.	26.	32.	38.	44.
3.	9.	15.	21.	27.	33.	39.	45.
4.	10.	16.	22.	28.	34.	40.	46.
5.	11.	17.	23.	29.	35.	41.	47.
6.	12.	18.	24.	30.	36.	42.	48.

**ARCHITECTURAL REQUIREMENTS**

<b>WALL AND CEILING</b> Wall Material: <input type="text" value="ARGB 1.2m AFF, GB above"/> Finish: <input type="text" value="HPC"/> Ceiling Material: <input type="text" value="MMRGB"/> Finish: <input type="text" value="HPC"/>	<b>WALL PROTECTION</b> Type: <input type="text" value="ESRP"/> <input type="checkbox"/> Corner Guards <input type="checkbox"/> Hand Rails <input type="checkbox"/> Bed Bumper / Locator Height: <input type="text" value="2185 mm"/> <input type="checkbox"/> Crash Rails <input type="checkbox"/> Chair Rail	<b>GLAZING</b> <input type="checkbox"/> Interior Glazing	<b>FLOORING TYPES</b> Material: <input type="text" value="WSVF"/> Base: <input type="text" value="FCB"/>	<b>ROOM ACCESSORIES</b> <input type="checkbox"/> Coat Hooks <input type="checkbox"/> Ceiling Lift <input checked="" type="checkbox"/> Magnetic Whiteboard <input type="checkbox"/> Mirror <input type="checkbox"/> Infant Change Table <input type="checkbox"/> Privacy Curtain
--	---	---	---	---

- LEGEND:**
- WALL AND CEILING LEGEND:**
- AC Architectural Ceiling
  - ACT Acoustic Ceiling Tile
  - ACT-C Cleanroom
  - ARGB Abuse-Resistant Gypsum Board
  - GB Gypsum Board
  - IRGB Impact-Resistant Gypsum Board
  - KLCT Kitchen Lay-in Ceiling Tile
  - MMRGB Moisture and Mould-Resistant Gypsum Board
  - SACT Security Acoustic Ceiling Tile
- WALL FINISHES LEGEND:**
- EWC Epoxy Wall Coating
  - HPC High Performance Coating
  - PT Paint
- CEILING FINISHES LEGEND:**
- ECC Epoxy Ceiling Coating
  - HPC High Performance Coating
  - PF Prefinished
  - PT Paint
- WALL PROTECTION LEGEND:**
- ESRP Extruded Semi-Rigid PVCu Panel
  - FRL Fibre Reinforced Laminate
  - FRP Fibreglass Reinforced Plastic
  - PVV Protective Vinyl Wallcovering
  - RHIS Rigid High Impact Sheet
  - WSSP Wetwall Solid Surface Panel
  - WVV Wetroom Vinyl Wallcovering
- FLOOR FINISHES LEGEND:**
- CFS Concrete Floor Sealer
  - EFC Epoxy Floor Coating
  - PFC Polyurethane Floor Coating
  - RAF Rubber Athletic Flooring
  - RSF Rubber Sheet Flooring
  - SCF Seamless Cushioned Flooring
  - SDRF Static-Dissipative Rubber Sheet Flooring
  - SDVF Static-Dissipative Vinyl Sheet Flooring
  - VSF Vinyl Sheet Flooring
  - WSVF Wetroom Safety Vinyl Sheet Flooring
- FLOOR BASE LEGEND:**
- FCB Flash Cove Base
  - RB Rubber Base
  - SCF Seamless Cushioned Flooring

**DOORS**

Types:

Type	Qty	Size (mm)	Material	Finish	Side Lt.	Blinds	Protect.	Privacy Film	Function	Card Reader	Mag Lock	Auto Opener	Hold Open	Hinges	Accessory 1	Accessory 2	Accessory 3	Closer	

Door Remarks:  Security Grille  Anti-barricade strategy

**MILLWORK AND SPECIALTY CASEWORK**

Storage Requirements:

**UPPER UNITS** (U1-U8) **SHELF** (S1)

**LOWER UNITS** (L1-L12) **RECEPTION/TRANSACTION COUNTER / CARE TEAM STATION DESK** (TC1, TC2) **UTILITY SINK AND COUNTER UNIT** (UC1)

**FULL-HEIGHT CABINETS** (C1-C5)

**Legend:**

Category	Min. Length (mm)	Motorized Adjustable Height	Standing Height	Specialty Casework
Category 0 - None				
Category 1 - Low (1% - 4%)				
Category 2 - Med (5% - 9%)				
Category 3 - High (10% or Greater)				

**FINISHES**

Full-height Cabinet:   
 Upper Millwork:   
 Countertop:   
 Lower Millwork:   
 Shelf:

Remarks:

**MECHANICAL REQUIREMENTS**

**PLUMBING**

Hand Hygiene Sink:	Lavatory:	Kitchen Sink:	Seamless Kitchen Sink:	Utility / Process Sink:	Scrub Sink:	Floor Sink:
<input type="text"/>	<input type="text"/>	<input type="text"/>	<input type="text"/>	<input type="text"/>	<input type="text"/>	<input type="text"/>

Other Fixtures:

- Shower
- Tub
- Ice Maker
- Water Closet
- Instantaneous Hot Water
- Eyewash Station
- Eyewash/Shower Station
- Emergency Shower
- Flush Rim Sink
- Floor Drain
- Water Bottle Refill Station

Other:

**MED / NON-MED GASES**

Oxygen:	Medical Air:	Medical Vacuum:	Nitrous Oxide:	CO2:	AGSS:	Nitrogen:	Laboratory Air:	Laboratory Vacuum:	Utility Compressed Air:
<input type="text"/>	<input type="text"/>	<input type="text"/>	<input type="text"/>	<input type="text"/>	<input type="text"/>	<input type="text"/>	<input type="text"/>	<input type="text"/>	4

Gas Remarks:



# Appendix 1B Minimum Room Requirements

Room Name:

Program Number(s):	1. P3.04	7.	13.	19.	25.	31.	37.	43.
	2.	8.	14.	20.	26.	32.	38.	44.
	3.	9.	15.	21.	27.	33.	39.	45.
	4.	10.	16.	22.	28.	34.	40.	46.
	5.	11.	17.	23.	29.	35.	41.	47.
	6.	12.	18.	24.	30.	36.	42.	48.

## ARCHITECTURAL REQUIREMENTS

<b>WALL AND CEILING</b> Wall Material: <input type="text" value="ARGB 1.2m AFF, GB above"/> Finish: <input type="text" value="PT"/> Ceiling Material: <input type="text" value="ACT"/> Finish: <input type="text" value="PF"/>	<b>WALL PROTECTION</b> Type: <input type="text" value="RHIS"/> <input checked="" type="checkbox"/> Corner Guards <input type="checkbox"/> Hand Rails <input type="checkbox"/> Bed Bumper / Locator Height: <input type="text" value="2185 mm"/> <input checked="" type="checkbox"/> Crash Rails <input type="checkbox"/> Chair Rail	<b>GLAZING</b> <input type="checkbox"/> Interior Glazing	<b>FLOORING TYPES</b> Material: <input type="text" value="WSVF"/> Base: <input type="text" value="FCB"/>	<b>ROOM ACCESSORIES</b> <input type="checkbox"/> Coat Hooks <input type="checkbox"/> Ceiling Lift <input type="checkbox"/> Magnetic Whiteboard <input type="checkbox"/> Mirror <input type="checkbox"/> Infant Change Table <input type="checkbox"/> Privacy Curtain
--	---	---	---	--

- LEGEND:**
- WALL AND CEILING LEGEND:**
- AC Architectural Ceiling
  - ACT Acoustic Ceiling Tile
  - ACT-C Cleanroom
  - ARGB Abuse-Resistant Gypsum Board
  - GB Gypsum Board
  - IRGB Impact-Resistant Gypsum Board
  - KLCT Kitchen Lay-in Ceiling Tile
  - MMRGB Moisture and Mould-Resistant Gypsum Board
  - SACT Security Acoustic Ceiling Tile
- WALL FINISHES LEGEND:**
- EWC Epoxy Wall Coating
  - HPC High Performance Coating
  - PT Paint
- CEILING FINISHES LEGEND:**
- ECC Epoxy Ceiling Coating
  - HPC High Performance Coating
  - PF Prefinished
  - PT Paint
- WALL PROTECTION LEGEND:**
- ESRP Extruded Semi-Rigid PVCu Panel
  - FRL Fibre Reinforced Laminate
  - FRP Fibreglass Reinforced Plastic
  - PVV Protective Vinyl Wallcovering
  - RHIS Rigid High Impact Sheet
  - WSSP Wetwall Solid Surface Panel
  - WVV Wetroom Vinyl Wallcovering
- FLOOR FINISHES LEGEND:**
- CFS Concrete Floor Sealer
  - EFC Epoxy Floor Coating
  - PFC Polyurethane Floor Coating
  - RAF Rubber Athletic Flooring
  - RSF Rubber Sheet Flooring
  - SCF Seamless Cushioned Flooring
  - SDRF Static-Dissipative Rubber Sheet Flooring
  - SDVF Static-Dissipative Vinyl Sheet Flooring
  - VSF Vinyl Sheet Flooring
  - WSVF Wetroom Safety Vinyl Sheet Flooring
- FLOOR BASE LEGEND:**
- FCB Flash Cove Base
  - RB Rubber Base
  - SCF Seamless Cushioned Flooring

**DOORS**

Types:

Type	Qty	Size (mm)	Material	Finish	Side Lt.	Blinds	Protect.	Privacy Film	Function	Card Reader	Mag Lock	Auto Opener	Hold Open	Hinges	Accessory 1	Accessory 2	Accessory 3	Closer
B	1	1220 x 2135	Hollow Metal	Paint	<input type="checkbox"/>	<input type="checkbox"/>		<input type="checkbox"/>	Passage	<input type="checkbox"/>	<input type="checkbox"/>	<input checked="" type="checkbox"/>	<input checked="" type="checkbox"/>	Butt Hinge	Elec. Strike			Surface
B	1	1220 x 2135	Hollow Metal	Paint	<input type="checkbox"/>	<input type="checkbox"/>		<input type="checkbox"/>	Storeroom	<input checked="" type="checkbox"/>	<input type="checkbox"/>	<input checked="" type="checkbox"/>	<input type="checkbox"/>	Butt Hinge	Elec. Strike			Surface

Door Remarks:  Security Grille  Anti-barricade strategy

**MILLWORK AND SPECIALTY CASEWORK**

**UPPER UNITS** (U1-U8) **LOWER UNITS** (L1-L12) **RECEPTION/TRANSACTION COUNTER / CARE TEAM STATION DESK** (TC1-TC2) **UTILITY SINK AND COUNTER UNIT** (UC1)

Storage Requirements:

**FINISHES**

Full-height Cabinet:   
 Upper Millwork:   
 Countertop:   
 Lower Millwork:   
 Shelf:

Remarks:

**Legend:**

Category	Min. Length (mm)	Motorized Adjustable Height	Standing Height	Specialty Casework
Category 0 - None		<input type="checkbox"/>	<input type="checkbox"/>	<input type="checkbox"/>
Category 1 - Low (1% - 4%)		<input type="checkbox"/>	<input type="checkbox"/>	<input type="checkbox"/>
Category 2 - Med (5% - 9%)		<input type="checkbox"/>	<input type="checkbox"/>	<input type="checkbox"/>
Category 3 - High (10% or Greater)		<input type="checkbox"/>	<input type="checkbox"/>	<input type="checkbox"/>

## MECHANICAL REQUIREMENTS

<b>PLUMBING</b> (Quantity) Hand Hygiene Sink: <input type="text"/> Lavatory: <input type="text"/> Kitchen Sink: <input type="text"/> Seamless Kitchen Sink: <input type="text"/> Utility / Process Sink: <input type="text"/> Scrub Sink: <input type="text"/> Floor Sink: <input type="text"/> Plumbing Remarks: <input type="text"/>	Other Fixtures: <input type="checkbox"/> Shower <input type="checkbox"/> Eyewash Station <input type="checkbox"/> Tub <input type="checkbox"/> Eyewash/Shower Station <input type="checkbox"/> Ice Maker <input type="checkbox"/> Emergency Shower <input type="checkbox"/> Water Closet <input type="checkbox"/> Flush Rim Sink <input type="checkbox"/> Instantaneous Hot Water <input type="checkbox"/> Floor Drain <input type="checkbox"/> <input type="checkbox"/> Water Bottle Refill Station Other <input type="text"/>	<b>MED / NON-MED GASES</b> (Quantity) Oxygen: <input type="text"/> Medical Air: <input type="text"/> Medical Vacuum: <input type="text"/> Nitrous Oxide: <input type="text"/> CO2: <input type="text"/> AGSS: <input type="text"/> Nitrogen: <input type="text"/> Laboratory Air: <input type="text"/> Laboratory Vacuum: <input type="text"/> Utility Compressed Air: <input type="text"/> Gas Remarks: <input type="text"/>
---	--	---

**Appendix 1B Minimum Room Requirements**

Room Name:

Program Number(s):

1. P1.01	7.	13.	19.	25.	31.	37.	43.
2.	8.	14.	20.	26.	32.	38.	44.
3.	9.	15.	21.	27.	33.	39.	45.
4.	10.	16.	22.	28.	34.	40.	46.
5.	11.	17.	23.	29.	35.	41.	47.
6.	12.	18.	24.	30.	36.	42.	48.

**ARCHITECTURAL REQUIREMENTS**

<b>WALL AND CEILING</b> Wall Material: <input type="text" value="ARGB 1.2m AFF, GB above"/> Finish: <input type="text" value="PT"/> Ceiling Material: <input type="text" value="ACT"/> Finish: <input type="text" value="PF"/>	<b>WALL PROTECTION</b> Type: <input type="text" value="RHIS"/> <input checked="" type="checkbox"/> Corner Guards <input type="checkbox"/> Hand Rails <input type="checkbox"/> Bed Bumper / Locator Height: <input type="text" value="2185 mm"/> <input checked="" type="checkbox"/> Crash Rails <input type="checkbox"/> Chair Rail	<b>GLAZING</b> <input type="checkbox"/> Interior Glazing	<b>FLOORING TYPES</b> Material: <input type="text" value="WSVF"/> Base: <input type="text" value="FCB"/>	<b>ROOM ACCESSORIES</b> <input type="checkbox"/> Coat Hooks <input type="checkbox"/> Ceiling Lift <input type="checkbox"/> Magnetic Whiteboard <input type="checkbox"/> Mirror <input type="checkbox"/> Infant Change Table <input type="checkbox"/> Privacy Curtain
--	---	---	---	--

- LEGEND:**
- WALL AND CEILING LEGEND:**
- AC Architectural Ceiling
  - ACT Acoustic Ceiling Tile
  - ACT-C Cleanroom
  - ARGB Abuse-Resistant Gypsum Board
  - GB Gypsum Board
  - IRGB Impact-Resistant Gypsum Board
  - KLCT Kitchen Lay-in Ceiling Tile
  - MMRGB Moisture and Mould-Resistant Gypsum Board
  - SACT Security Acoustic Ceiling Tile
- WALL FINISHES LEGEND:**
- EWC Epoxy Wall Coating
  - HPC High Performance Coating
  - PT Paint
- CEILING FINISHES LEGEND:**
- ECC Epoxy Ceiling Coating
  - HPC High Performance Coating
  - PF Prefinished
  - PT Paint
- WALL PROTECTION LEGEND:**
- ESRP Extruded Semi-Rigid PVCu Panel
  - FRL Fibre Reinforced Laminate
  - FRP Fibreglass Reinforced Plastic
  - PVV Protective Vinyl Wallcovering
  - RHIS Rigid High Impact Sheet
  - WSSP Wetwall Solid Surface Panel
  - WVV Wetroom Vinyl Wallcovering
- FLOOR FINISHES LEGEND:**
- CFS Concrete Floor Sealer
  - EFC Epoxy Floor Coating
  - PFC Polyurethane Floor Coating
  - RAF Rubber Athletic Flooring
  - RSF Rubber Sheet Flooring
  - SCF Seamless Cushioned Flooring
  - SDRF Static-Dissipative Rubber Sheet Flooring
  - SDVF Static-Dissipative Vinyl Sheet Flooring
  - VSF Vinyl Sheet Flooring
  - WSVF Wetroom Safety Vinyl Sheet Flooring
- FLOOR BASE LEGEND:**
- FCB Flash Cove Base
  - RB Rubber Base
  - SCF Seamless Cushioned Flooring

**DOORS**

Types:

Type	Qty	Size (mm)	Material	Finish	Side Lt.	Blinds	Protect.	Privacy Film	Function	Card Reader	Mag Lock	Auto Opener	Hold Open	Hinges	Accessory 1	Accessory 2	Accessory 3	Closer
C	1	1220 x 2135	Solid Core	FRL	<input type="checkbox"/>	<input type="checkbox"/>	2 High	<input type="checkbox"/>	Storeroom	<input checked="" type="checkbox"/>	<input type="checkbox"/>	<input type="checkbox"/>	<input checked="" type="checkbox"/>	Butt Hinge				Surface
G	1	1220 x 2135	Aluminum	Prefinished	<input type="checkbox"/>	<input type="checkbox"/>	2 High	<input type="checkbox"/>	Storeroom	<input checked="" type="checkbox"/>	<input type="checkbox"/>	<input checked="" type="checkbox"/>	<input type="checkbox"/>	Butt Hinge	Elec. Strike			Surface

Door Remarks:  Security Grille  Anti-barricade strategy

**MILLWORK AND SPECIALTY CASEWORK**

Storage Requirements:

**FINISHES**

Full-height Cabinet:

Upper Millwork:

Countertop:

Lower Millwork:

Shelf:

Remarks:

**Legend:**

Category	Min. Length (mm)	Motorized Adjustable Height	Standing Height	Specialty Casework
Category 0 - None		<input type="checkbox"/>	<input type="checkbox"/>	<input type="checkbox"/>
Category 1 - Low (1% - 4%)		<input type="checkbox"/>	<input type="checkbox"/>	<input type="checkbox"/>
Category 2 - Med (5% - 9%)		<input type="checkbox"/>	<input type="checkbox"/>	<input type="checkbox"/>
Category 3 - High (10% or Greater)		<input type="checkbox"/>	<input type="checkbox"/>	<input type="checkbox"/>

**MECHANICAL REQUIREMENTS**

<b>PLUMBING</b> (Quantity) Hand Hygiene Sink: <input type="text" value="1"/> Lavatory: <input type="text"/> Kitchen Sink: <input type="text"/> Seamless Kitchen Sink: <input type="text"/> Utility / Process Sink: <input type="text"/> Scrub Sink: <input type="text"/> Floor Sink: <input type="text"/> Plumbing Remarks: <input type="text"/>	Other Fixtures: <input type="checkbox"/> Shower <input type="checkbox"/> Tub <input type="checkbox"/> Ice Maker <input type="checkbox"/> Water Closet <input type="checkbox"/> Instantaneous Hot Water <input type="checkbox"/> Eyewash Station <input type="checkbox"/> Eyewash/Shower Station <input type="checkbox"/> Emergency Shower <input type="checkbox"/> Flush Rim Sink <input type="checkbox"/> Floor Drain <input type="checkbox"/> Water Bottle Refill Station Other: <input type="text"/>	<b>MED / NON-MED GASES</b> (Quantity) Oxygen: <input type="text"/> Medical Air: <input type="text"/> Medical Vacuum: <input type="text"/> Nitrous Oxide: <input type="text"/> CO2: <input type="text"/> AGSS: <input type="text"/> Nitrogen: <input type="text"/> Laboratory Air: <input type="text"/> Laboratory Vacuum: <input type="text"/> Utility Compressed Air: <input type="text"/> Gas Remarks: <input type="text"/>
--	--	---

**Appendix 1B Minimum Room Requirements**

Room Name:

Program Number(s):

1.	P1.10	7.		13.		19.		25.		31.		37.		43.
2.		8.		14.		20.		26.		32.		38.		44.
3.		9.		15.		21.		27.		33.		39.		45.
4.		10.		16.		22.		28.		34.		40.		46.
5.		11.		17.		23.		29.		35.		41.		47.
6.		12.		18.		24.		30.		36.		42.		48.

**ARCHITECTURAL REQUIREMENTS**

<b>WALL AND CEILING</b> Wall Material: <input type="text" value="ARGB 1.2m AFF, GB above"/> Finish: <input type="text" value="HPC"/> Ceiling Material: <input type="text" value="MMRGB"/> Finish: <input type="text" value="HPC"/>		<b>WALL PROTECTION</b> Type: <input type="text" value="ESRP"/> <input checked="" type="checkbox"/> Corner Guards <input type="checkbox"/> Hand Rails <input type="checkbox"/> Bed Bumper / Locator Height: <input type="text" value="2185 mm"/> <input type="checkbox"/> Crash Rails <input type="checkbox"/> Chair Rail			<b>GLAZING</b> <input type="checkbox"/> Interior Glazing		<b>FLOORING TYPES</b> Material: <input type="text" value="WSVF"/> Base: <input type="text" value="FCB"/>		<b>ROOM ACCESSORIES</b> <input type="checkbox"/> Coat Hooks <input type="checkbox"/> Ceiling Lift <input type="checkbox"/> Magnetic Whiteboard <input type="checkbox"/> Mirror <input type="checkbox"/> Infant Change Table <input type="checkbox"/> Privacy Curtain		
--	--	--	--	--	---	--	---	--	--	--	--

- LEGEND:**
- WALL AND CEILING LEGEND:**
- AC Architectural Ceiling
  - ACT Acoustic Ceiling Tile
  - ACT-C Cleanroom
  - ARGB Abuse-Resistant Gypsum Board
  - GB Gypsum Board
  - IRGB Impact-Resistant Gypsum Board
  - KLCT Kitchen Lay-in Ceiling Tile
  - MMRGB Moisture and Mould-Resistant Gypsum Board
  - SACT Security Acoustic Ceiling Tile
- WALL FINISHES LEGEND:**
- EWC Epoxy Wall Coating
  - HPC High Performance Coating
  - PT Paint
- CEILING FINISHES LEGEND:**
- ECC Epoxy Ceiling Coating
  - HPC High Performance Coating
  - PF Prefinished
  - PT Paint
- WALL PROTECTION LEGEND:**
- ESRP Extruded Semi-Rigid PVCu Panel
  - FRL Fibre Reinforced Laminate
  - FRP Fibreglass Reinforced Plastic
  - PVV Protective Vinyl Wallcovering
  - RHIS Rigid High Impact Sheet
  - WSSP Wetwall Solid Surface Panel
  - WVV Wetroom Vinyl Wallcovering
- FLOOR FINISHES LEGEND:**
- CFS Concrete Floor Sealer
  - EFC Epoxy Floor Coating
  - PFC Polyurethane Floor Coating
  - RAF Rubber Athletic Flooring
  - RSF Rubber Sheet Flooring
  - SCF Seamless Cushioned Flooring
  - SDRF Static-Dissipative Rubber Sheet Flooring
  - SDVF Static-Dissipative Vinyl Sheet Flooring
  - VSF Vinyl Sheet Flooring
  - WSVF Wetroom Safety Vinyl Sheet Flooring
- FLOOR BASE LEGEND:**
- FCB Flash Cove Base
  - RB Rubber Base
  - SCF Seamless Cushioned Flooring

**DOORS**

Types:

Note: for Type F doors, the door panels will be approximately 465/1065 unless otherwise required by the Authority

Door Remarks:  Security Grille  Anti-barricade strategy

Type	Qty	Size (mm)	Material	Finish	Side Lt.	Blinds	Protect.	Privacy Film	Function	Card Reader	Mag Lock	Auto Opener	Hold Open	Hinges	Accessory 1	Accessory 2	Accessory 3	Closer
F2	1	1530 x 2135	Solid Core	FRL	<input type="checkbox"/>	<input type="checkbox"/>	2 High	<input checked="" type="checkbox"/>	Storeroom	<input checked="" type="checkbox"/>	<input type="checkbox"/>	<input type="checkbox"/>	<input type="checkbox"/>	Butt Hinge	Astragal	Flush Bolt		Surface

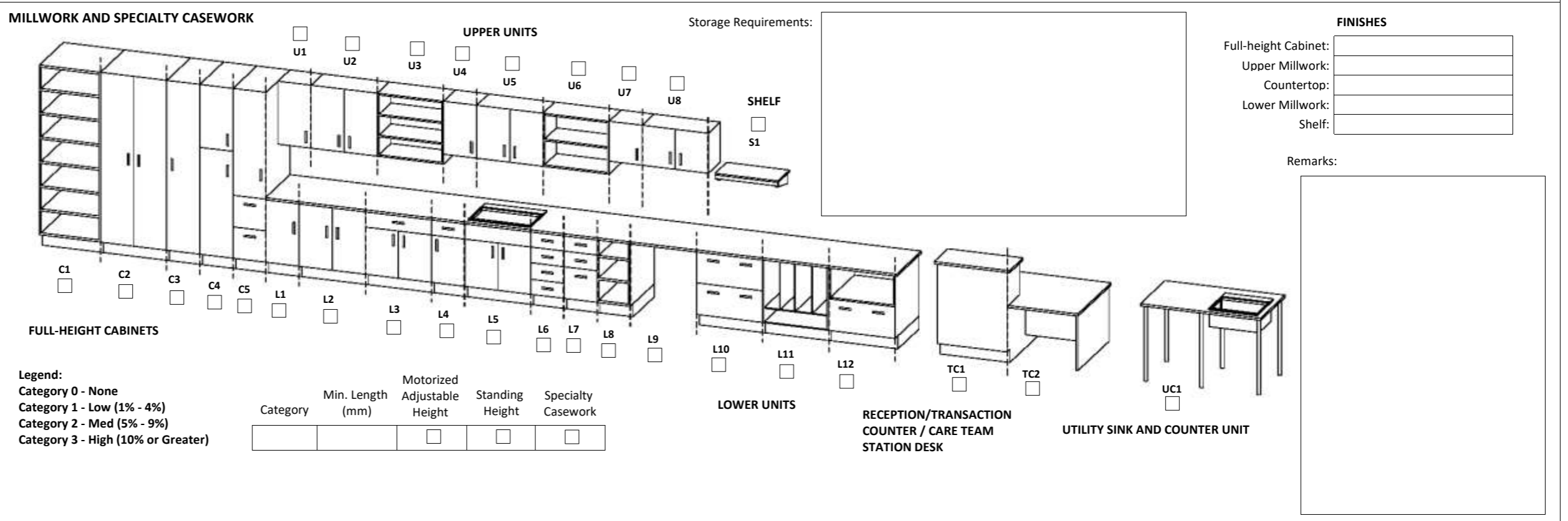

**MECHANICAL REQUIREMENTS**

<b>PLUMBING</b> (Quantity) Hygiene Sink: <input type="text"/> Lavatory: <input type="text"/> Kitchen Sink: <input type="text"/> Kitchen Sink: <input type="text"/> Utility / Process Sink: <input type="text"/> Scrub Sink: <input type="text"/> Floor Sink: <input type="text"/>							Other Fixtures: <input type="checkbox"/> Shower <input type="checkbox"/> Eyewash Station <input type="checkbox"/> Tub <input type="checkbox"/> Eyewash/Shower Station <input type="checkbox"/> Ice Maker <input type="checkbox"/> Emergency Shower <input type="checkbox"/> Water Closet <input checked="" type="checkbox"/> Floor Drain <input type="checkbox"/> Instantaneous Hot Water <input type="checkbox"/> Water Bottle Refill Station Other <input type="text"/>				<b>MED / NON-MED GASES</b> (Quantity) Oxygen: <input type="text"/> Medical Air: <input type="text"/> Medical Vacuum: <input type="text"/> Nitrous Oxide: <input type="text"/> CO2: <input type="text"/> AGSS: <input type="text"/> Nitrogen: <input type="text"/> Laboratory Air: <input type="text"/> Laboratory Vacuum: <input type="text"/> Utility Compressed Air: <input type="text"/>					
Plumbing Remarks: <input type="text" value="Provide raised threshold required for water containment"/>											Gas Remarks: <input type="text"/>					



**Appendix 1B Minimum Room Requirements**

Room Name:

Program Number(s):

1. P2.03.03	7.	13.	19.	25.	31.	37.	43.
2.	8.	14.	20.	26.	32.	38.	44.
3.	9.	15.	21.	27.	33.	39.	45.
4.	10.	16.	22.	28.	34.	40.	46.
5.	11.	17.	23.	29.	35.	41.	47.
6.	12.	18.	24.	30.	36.	42.	48.

**ARCHITECTURAL REQUIREMENTS**

<b>WALL AND CEILING</b> Wall Material: <input type="text" value="ARGB 1.2m AFF, GB above"/> Finish: <input type="text" value="HPC"/> Ceiling Material: <input type="text" value="MMRGB"/> Finish: <input type="text" value="HPC"/>	<b>WALL PROTECTION</b> Type: <input type="text" value="ESRP"/> <input type="checkbox"/> Corner Guards <input type="checkbox"/> Hand Rails <input type="checkbox"/> Bed Bumper / Locator Height: <input type="text" value="2185 mm"/> <input type="checkbox"/> Crash Rails <input type="checkbox"/> Chair Rail	<b>GLAZING</b> <input type="checkbox"/> Interior Glazing	<b>FLOORING TYPES</b> Material: <input type="text" value="WSVF"/> Base: <input type="text" value="FCB"/>	<b>ROOM ACCESSORIES</b> <input type="checkbox"/> Coat Hooks <input type="checkbox"/> Ceiling Lift <input checked="" type="checkbox"/> Magnetic Whiteboard <input type="checkbox"/> Mirror <input type="checkbox"/> Infant Change Table <input type="checkbox"/> Privacy Curtain
--	---	---	---	---

- LEGEND:**
- WALL AND CEILING LEGEND:**
- AC Architectural Ceiling
  - ACT Acoustic Ceiling Tile
  - ACT-C Cleanroom
  - ARGB Abuse-Resistant Gypsum Board
  - GB Gypsum Board
  - IRGB Impact-Resistant Gypsum Board
  - KLCT Kitchen Lay-in Ceiling Tile
  - MMRGB Moisture and Mould-Resistant Gypsum Board
  - SACT Security Acoustic Ceiling Tile
- WALL FINISHES LEGEND:**
- EWC Epoxy Wall Coating
  - HPC High Performance Coating
  - PT Paint
- CEILING FINISHES LEGEND:**
- ECC Epoxy Ceiling Coating
  - HPC High Performance Coating
  - PF Prefinished
  - PT Paint
- WALL PROTECTION LEGEND:**
- ESRP Extruded Semi-Rigid PVCu Panel
  - FRL Fibre Reinforced Laminate
  - FRP Fibreglass Reinforced Plastic
  - PVV Protective Vinyl Wallcovering
  - RHIS Rigid High Impact Sheet
  - WSSP Wetwall Solid Surface Panel
  - WVV Wetroom Vinyl Wallcovering
- FLOOR FINISHES LEGEND:**
- CFS Concrete Floor Sealer
  - EFC Epoxy Floor Coating
  - PFC Polyurethane Floor Coating
  - RAF Rubber Athletic Flooring
  - RSF Rubber Sheet Flooring
  - SCF Seamless Cushioned Flooring
  - SDRF Static-Dissipative Rubber Sheet Flooring
  - SDVF Static-Dissipative Vinyl Sheet Flooring
  - VSF Vinyl Sheet Flooring
  - WSVF Wetroom Safety Vinyl Sheet Flooring
- FLOOR BASE LEGEND:**
- FCB Flash Cove Base
  - RB Rubber Base
  - SCF Seamless Cushioned Flooring

**DOORS**

Types:

Type:Qty:	Size (mm):	Material:	Finish:	Side Lt:	Blinds:	Protect.:	Privacy Film:	Function:	Card Reader:	Mag Lock:	Auto Opener:	Hold Open:	Hinges:	Accessory 1:	Accessory 2:	Accessory 3:	Closer:

Door Remarks:  Security Grille  Anti-barricade strategy

**MILLWORK AND SPECIALTY CASEWORK**

Storage Requirements:

**UPPER UNITS** (U1-U8) **SHELF** (S1)

**LOWER UNITS** (L1-L12) **RECEPTION/TRANSACTION COUNTER / CARE TEAM STATION DESK** (TC1, TC2) **UTILITY SINK AND COUNTER UNIT** (UC1)

**FULL-HEIGHT CABINETS** (C1-C5)

**Legend:**

Category	Min. Length (mm)	Motorized Adjustable Height	Standing Height	Specialty Casework
Category 0 - None				
Category 1 - Low (1% - 4%)				
Category 2 - Med (5% - 9%)				
Category 3 - High (10% or Greater)				

**FINISHES**

Full-height Cabinet:   
 Upper Millwork:   
 Countertop:   
 Lower Millwork:   
 Shelf:

Remarks:

**MECHANICAL REQUIREMENTS**

**PLUMBING** (Quantity)

Hand Hygiene Sink:	Lavatory:	Kitchen Sink:	Seamless Kitchen Sink:	Utility / Process Sink:	Scrub Sink:	Floor Sink:

Plumbing Remarks:

**Other Fixtures:**

- Shower
- Tub
- Ice Maker
- Water Closet
- Instantaneous Hot Water
- Eyewash Station
- Eyewash/Shower Station
- Emergency Shower
- Flush Rim Sink
- Floor Drain
- Water Bottle Refill Station

Other:

**MED / NON-MED GASES** (Quantity)

Oxygen:	Medical Air:	Medical Vacuum:	Nitrous Oxide:	CO2:	AGSS:	Nitrogen:	Laboratory Air:	Laboratory Vacuum:	Utility Compressed Air:
									2

Gas Remarks:

**Appendix 1B Minimum Room Requirements**

Room Name:

Program Number(s):

1. P1.03.04	7.	13.	19.	25.	31.	37.	43.
2.	8.	14.	20.	26.	32.	38.	44.
3.	9.	15.	21.	27.	33.	39.	45.
4.	10.	16.	22.	28.	34.	40.	46.
5.	11.	17.	23.	29.	35.	41.	47.
6.	12.	18.	24.	30.	36.	42.	48.

**ARCHITECTURAL REQUIREMENTS**

<b>WALL AND CEILING</b> Wall Material: <input type="text" value="ARGB 1.2m AFF, GB above"/> Finish: <input type="text" value="HPC"/> Ceiling Material: <input type="text" value="MMRGB"/> Finish: <input type="text" value="HPC"/>		<b>WALL PROTECTION</b> Type: <input type="text" value="ESRP"/> <input type="checkbox"/> Corner Guards <input type="checkbox"/> Hand Rails <input type="checkbox"/> Bed Bumper / Locator Height: <input type="text" value="2185 mm"/> <input type="checkbox"/> Crash Rails <input type="checkbox"/> Chair Rail			<b>GLAZING</b> <input type="checkbox"/> Interior Glazing		<b>FLOORING TYPES</b> Material: <input type="text" value="WSVF"/> Base: <input type="text" value="FCB"/>		<b>ROOM ACCESSORIES</b> <input type="checkbox"/> Coat Hooks <input type="checkbox"/> Ceiling Lift <input type="checkbox"/> Magnetic Whiteboard <input type="checkbox"/> Mirror <input type="checkbox"/> Infant Change Table <input type="checkbox"/> Privacy Curtain		
--	--	---	--	--	---	--	---	--	--	--	--

- LEGEND:**
- WALL AND CEILING LEGEND:**
- AC Architectural Ceiling
  - ACT Acoustic Ceiling Tile
  - ACT-C Cleanroom
  - ARGB Abuse-Resistant Gypsum Board
  - GB Gypsum Board
  - IRGB Impact-Resistant Gypsum Board
  - KLCT Kitchen Lay-in Ceiling Tile
  - MMRGB Moisture and Mould-Resistant Gypsum Board
  - SACT Security Acoustic Ceiling Tile
- WALL FINISHES LEGEND:**
- EWC Epoxy Wall Coating
  - HPC High Performance Coating
  - PT Paint
- CEILING FINISHES LEGEND:**
- ECC Epoxy Ceiling Coating
  - HPC High Performance Coating
  - PF Prefinished
  - PT Paint
- WALL PROTECTION LEGEND:**
- ESRP Extruded Semi-Rigid PVCu Panel
  - FRL Fibre Reinforced Laminate
  - FRP Fibreglass Reinforced Plastic
  - PVV Protective Vinyl Wallcovering
  - RHIS Rigid High Impact Sheet
  - WSSP Wetwall Solid Surface Panel
  - WVV Wetroom Vinyl Wallcovering
- FLOOR FINISHES LEGEND:**
- CFS Concrete Floor Sealer
  - EFC Epoxy Floor Coating
  - PFC Polyurethane Floor Coating
  - RAF Rubber Athletic Flooring
  - RSF Rubber Sheet Flooring
  - SCF Seamless Cushioned Flooring
  - SDRF Static-Dissipative Rubber Sheet Flooring
  - SDVF Static-Dissipative Vinyl Sheet Flooring
  - VSF Vinyl Sheet Flooring
  - WSVF Wetroom Safety Vinyl Sheet Flooring
- FLOOR BASE LEGEND:**
- FCB Flash Cove Base
  - RB Rubber Base
  - SCF Seamless Cushioned Flooring

**DOORS**

Types:

Type	Qty	Size (mm)	Material	Finish	Side Lt.	Blinds	Protect.	Privacy Film	Function	Card Reader	Mag Lock	Auto Opener	Hold Open	Hinges	Accessory 1	Accessory 2	Accessory 3	Closer

Door Remarks:  Security Grille  Anti-barricade strategy

**MILLWORK AND SPECIALTY CASEWORK**

Storage Requirements:

**UPPER UNITS** (U1-U8) **SHELF** (S1)

**LOWER UNITS** (L1-L12) **RECEPTION/TRANSACTION COUNTER / CARE TEAM STATION DESK** (TC1, TC2) **UTILITY SINK AND COUNTER UNIT** (UC1)

**FULL-HEIGHT CABINETS** (C1-C5)

**Legend:**

Category	Min. Length (mm)	Motorized Adjustable Height	Standing Height	Specialty Casework
Category 0 - None				
Category 1 - Low (1% - 4%)				
Category 2 - Med (5% - 9%)				
Category 3 - High (10% or Greater)				

**FINISHES**

Full-height Cabinet:   
 Upper Millwork:   
 Countertop:   
 Lower Millwork:   
 Shelf:

Remarks:

**MECHANICAL REQUIREMENTS**

<b>PLUMBING</b> (Quantity) Hygiene Sink: <input type="text"/> Lavatory: <input type="text"/> Kitchen Sink: <input type="text"/> Kitchen Sink: <input type="text"/> Utility / Process Sink: <input type="text" value="2"/> Scrub Sink: <input type="text"/> Floor Sink: <input type="text"/>							Other Fixtures: <input type="checkbox"/> Shower <input type="checkbox"/> Eyewash Station <input type="checkbox"/> Tub <input type="checkbox"/> Eyewash/Shower Station <input type="checkbox"/> Ice Maker <input type="checkbox"/> Emergency Shower <input type="checkbox"/> Water Closet <input type="checkbox"/> Flush Rim Sink <input type="checkbox"/> Instantaneous Hot Water <input type="checkbox"/> Floor Drain <input type="checkbox"/> <input type="checkbox"/> Water Bottle Refill Station Other <input type="text"/>				<b>MED / NON-MED GASES</b> (Quantity) Oxygen: <input type="text"/> Medical Air: <input type="text" value="1"/> Medical Vacuum: <input type="text"/> Nitrous Oxide: <input type="text"/> CO2: <input type="text"/> AGSS: <input type="text"/> Nitrogen: <input type="text"/> Laboratory Air: <input type="text"/> Laboratory Vacuum: <input type="text" value="1"/> Utility Compressed Air: <input type="text"/>				
Plumbing Remarks: <input type="text" value="Refer to Appendix 1H [Equipment and Furniture] for reprocessing sink types"/>							Gas Remarks: <input type="text" value="Refer to Schedule 1, Section 7.5.11 - Ventilation, for Exhaust Systems Requirements. Provide (1) medical air and (1) vacuum per double sink bath."/>								

**Appendix 1B Minimum Room Requirements**

Room Name:

Program Number(s):

1. P1.03.01	7.	13.	19.	25.	31.	37.	43.
2.	8.	14.	20.	26.	32.	38.	44.
3.	9.	15.	21.	27.	33.	39.	45.
4.	10.	16.	22.	28.	34.	40.	46.
5.	11.	17.	23.	29.	35.	41.	47.
6.	12.	18.	24.	30.	36.	42.	48.

**ARCHITECTURAL REQUIREMENTS**

<b>WALL AND CEILING</b> Wall Material: <input type="text" value="ARGB 1.2m AFF, GB above"/> Finish: <input type="text" value="HPC"/> Ceiling Material: <input type="text" value="MMRGB"/> Finish: <input type="text" value="HPC"/>	<b>WALL PROTECTION</b> Type: <input type="text" value="ESRP"/> <input checked="" type="checkbox"/> Corner Guards <input type="checkbox"/> Hand Rails <input type="checkbox"/> Bed Bumper / Locator Height: <input type="text" value="2185 mm"/> <input checked="" type="checkbox"/> Crash Rails <input type="checkbox"/> Chair Rail	<b>GLAZING</b> <input type="checkbox"/> Interior Glazing	<b>FLOORING TYPES</b> Material: <input type="text" value="WSVF"/> Base: <input type="text" value="FCB"/>	<b>ROOM ACCESSORIES</b> <input type="checkbox"/> Coat Hooks <input type="checkbox"/> Ceiling Lift <input type="checkbox"/> Magnetic Whiteboard <input type="checkbox"/> Mirror <input type="checkbox"/> Infant Change Table <input type="checkbox"/> Privacy Curtain
--	---	---	---	--

- LEGEND:**
- WALL AND CEILING LEGEND:**
- AC Architectural Ceiling
  - ACT Acoustic Ceiling Tile
  - ACT-C Cleanroom
  - ARGB Abuse-Resistant Gypsum Board
  - GB Gypsum Board
  - IRGB Impact-Resistant Gypsum Board
  - KLCT Kitchen Lay-in Ceiling Tile
  - MMRGB Moisture and Mould-Resistant Gypsum Board
  - SACT Security Acoustic Ceiling Tile
- WALL FINISHES LEGEND:**
- EWC Epoxy Wall Coating
  - HPC High Performance Coating
  - PT Paint
- CEILING FINISHES LEGEND:**
- ECC Epoxy Ceiling Coating
  - HPC High Performance Coating
  - PF Prefinished
  - PT Paint
- WALL PROTECTION LEGEND:**
- ESRP Extruded Semi-Rigid PVCu Panel
  - FRL Fibre Reinforced Laminate
  - FRP Fibreglass Reinforced Plastic
  - PVV Protective Vinyl Wallcovering
  - RHIS Rigid High Impact Sheet
  - WSSP Wetwall Solid Surface Panel
  - WVV Wetroom Vinyl Wallcovering
- FLOOR FINISHES LEGEND:**
- CFS Concrete Floor Sealer
  - EFC Epoxy Floor Coating
  - PFC Polyurethane Floor Coating
  - RAF Rubber Athletic Flooring
  - RSF Rubber Sheet Flooring
  - SCF Seamless Cushioned Flooring
  - SDRF Static-Dissipative Rubber Sheet Flooring
  - SDVF Static-Dissipative Vinyl Sheet Flooring
  - VSF Vinyl Sheet Flooring
  - WSVF Wetroom Safety Vinyl Sheet Flooring
- FLOOR BASE LEGEND:**
- FCB Flash Cove Base
  - RB Rubber Base
  - SCF Seamless Cushioned Flooring

**DOORS**

Types:

Type	Qty	Size (mm)	Material	Finish	Side Lt	Blinds	Protect	Privacy Film	Function	Card Reader	Mag Lock	Auto Opener	Hold Open	Hinges	Accessory 1	Accessory 2	Accessory 3	Closer	

Door Remarks:  Security Grille  Anti-barricade strategy

**MILLWORK AND SPECIALTY CASEWORK**

**UPPER UNITS** (U1-U8) **SHELF** (S1)

**LOWER UNITS** (L1-L12) **RECEPTION/TRANSACTION COUNTER / CARE TEAM STATION DESK** (TC1, TC2) **UTILITY SINK AND COUNTER UNIT** (UC1)

**FULL-HEIGHT CABINETS** (C1-C5)

Storage Requirements:

**FINISHES**

Full-height Cabinet:   
 Upper Millwork:   
 Countertop:   
 Lower Millwork:   
 Shelf:

Remarks:

**Legend:**

Category	Min. Length (mm)	Motorized Adjustable Height	Standing Height	Specialty Casework
Category 0 - None				
Category 1 - Low (1% - 4%)				
Category 2 - Med (5% - 9%)				
Category 3 - High (10% or Greater)				

**MECHANICAL REQUIREMENTS**

<b>PLUMBING</b> (Quantity) Hand Hygiene Sink: <input type="text" value="1"/> Lavatory: <input type="text"/> Kitchen Sink: <input type="text"/> Seamless Kitchen Sink: <input type="text"/> Utility / Process Sink: <input type="text"/> Scrub Sink: <input type="text"/> Floor Sink: <input type="text"/> Plumbing Remarks: <input type="text"/>	Other Fixtures: <input type="checkbox"/> Shower <input type="checkbox"/> Tub <input type="checkbox"/> Ice Maker <input type="checkbox"/> Water Closet <input type="checkbox"/> Instantaneous Hot Water <input type="checkbox"/> Eyewash Station <input checked="" type="checkbox"/> Eyewash/Shower Station <input type="checkbox"/> Emergency Shower <input type="checkbox"/> Flush Rim Sink <input checked="" type="checkbox"/> Floor Drain <input type="checkbox"/> Water Bottle Refill Station Other <input type="text"/>	<b>MED / NON-MED GASES</b> (Quantity) Oxygen: <input type="text"/> Medical Air: <input type="text"/> Medical Vacuum: <input type="text"/> Nitrous Oxide: <input type="text"/> CO2: <input type="text"/> AGSS: <input type="text"/> Nitrogen: <input type="text"/> Laboratory Air: <input type="text"/> Laboratory Vacuum: <input type="text"/> Utility Compressed Air: <input type="text"/> Gas Remarks: <input type="text"/>
--	---	---



**Appendix 1B Minimum Room Requirements**

Room Name:

Program Number(s):

1.	P2.03.04	7.		13.		19.		25.		31.		37.		43.
2.		8.		14.		20.		26.		32.		38.		44.
3.		9.		15.		21.		27.		33.		39.		45.
4.		10.		16.		22.		28.		34.		40.		46.
5.		11.		17.		23.		29.		35.		41.		47.
6.		12.		18.		24.		30.		36.		42.		48.

**ARCHITECTURAL REQUIREMENTS**

<b>WALL AND CEILING</b> Wall Material: <input type="text" value="ARGB 1.2m AFF, GB above"/> Finish: <input type="text" value="HPC"/> Ceiling Material: <input type="text" value="MMRGB"/> Finish: <input type="text" value="HPC"/>		<b>WALL PROTECTION</b> Type: <input type="text" value="ESRP"/> <input type="checkbox"/> Corner Guards <input type="checkbox"/> Hand Rails <input type="checkbox"/> Bed Bumper / Locator Height: <input type="text" value="2185 mm"/> <input type="checkbox"/> Crash Rails <input type="checkbox"/> Chair Rail			<b>GLAZING</b> <input type="checkbox"/> Interior Glazing		<b>FLOORING TYPES</b> Material: <input type="text" value="WSVF"/> Base: <input type="text" value="FCB"/>		<b>ROOM ACCESSORIES</b> <input type="checkbox"/> Coat Hooks <input type="checkbox"/> Ceiling Lift <input type="checkbox"/> Magnetic Whiteboard <input type="checkbox"/> Mirror <input type="checkbox"/> Infant Change Table <input type="checkbox"/> Privacy Curtain		
--	--	---	--	--	---	--	---	--	--	--	--

- LEGEND:**
- WALL AND CEILING LEGEND:**
- AC Architectural Ceiling
  - ACT Acoustic Ceiling Tile
  - ACT-C Cleanroom
  - ARGB Abuse-Resistant Gypsum Board
  - GB Gypsum Board
  - IRGB Impact-Resistant Gypsum Board
  - KLCT Kitchen Lay-in Ceiling Tile
  - MMRGB Moisture and Mould-Resistant Gypsum Board
  - SACT Security Acoustic Ceiling Tile
- WALL FINISHES LEGEND:**
- EWC Epoxy Wall Coating
  - HPC High Performance Coating
  - PT Paint
- CEILING FINISHES LEGEND:**
- ECC Epoxy Ceiling Coating
  - HPC High Performance Coating
  - PF Prefinished
  - PT Paint
- WALL PROTECTION LEGEND:**
- ESRP Extruded Semi-Rigid PVCu Panel
  - FRL Fibre Reinforced Laminate
  - FRP Fibreglass Reinforced Plastic
  - PVV Protective Vinyl Wallcovering
  - RHIS Rigid High Impact Sheet
  - WSSP Wetwall Solid Surface Panel
  - WVV Wetroom Vinyl Wallcovering
- FLOOR FINISHES LEGEND:**
- CFS Concrete Floor Sealer
  - EFC Epoxy Floor Coating
  - PFC Polyurethane Floor Coating
  - RAF Rubber Athletic Flooring
  - RSF Rubber Sheet Flooring
  - SCF Seamless Cushioned Flooring
  - SDRF Static-Dissipative Rubber Sheet Flooring
  - SDVF Static-Dissipative Vinyl Sheet Flooring
  - VSF Vinyl Sheet Flooring
  - WSVF Wetroom Safety Vinyl Sheet Flooring
- FLOOR BASE LEGEND:**
- FCB Flash Cove Base
  - RB Rubber Base
  - SCF Seamless Cushioned Flooring

**DOORS**

Types:

Type:Qty:	Size (mm):	Material:	Finish:	Side Lt:	Blinds:	Protect.:	Privacy Film:	Function:	Card Reader:	Mag Lock:	Auto Opener:	Hold Open:	Hinges:	Accessory 1:	Accessory 2:	Accessory 3:	Closer:	

Door Remarks:  Security Grille  Anti-barricade strategy

**MILLWORK AND SPECIALTY CASEWORK**

**UPPER UNITS** (U1-U8) **LOWER UNITS** (L1-L12) **SHELF** (S1) **RECEPTION/TRANSACTION COUNTER / CARE TEAM STATION DESK** (TC1, TC2) **UTILITY SINK AND COUNTER UNIT** (UC1)

Storage Requirements:

**FINISHES**

Full-height Cabinet:   
 Upper Millwork:   
 Countertop:   
 Lower Millwork:   
 Shelf:

Remarks:

**Legend:**

Category	Min. Length (mm)	Motorized Adjustable Height	Standing Height	Specialty Casework
Category 0 - None				
Category 1 - Low (1% - 4%)				
Category 2 - Med (5% - 9%)				
Category 3 - High (10% or Greater)				

**MECHANICAL REQUIREMENTS**

<b>PLUMBING</b> (Quantity) Hygiene Sink: <input type="text"/> Lavatory: <input type="text"/> Kitchen Sink: <input type="text"/> Seamless Kitchen Sink: <input type="text"/> Utility / Process Sink: <input type="text"/> Scrub Sink: <input type="text"/> Floor Sink: <input type="text"/>							Other Fixtures: <input type="checkbox"/> Shower <input type="checkbox"/> Tub <input type="checkbox"/> Ice Maker <input type="checkbox"/> Water Closet <input type="checkbox"/> Instantaneous Hot Water				<input type="checkbox"/> Eyewash Station <input type="checkbox"/> Eyewash/Shower Station <input type="checkbox"/> Emergency Shower <input type="checkbox"/> Flush Rim Sink <input type="checkbox"/> Floor Drain <input type="checkbox"/> Water Bottle Refill Station				<b>MED / NON-MED GASES</b> (Quantity) Oxygen: <input type="text"/> Medical Air: <input type="text"/> Medical Vacuum: <input type="text"/> Nitrous Oxide: <input type="text"/> CO2: <input type="text"/> AGSS: <input type="text"/> Nitrogen: <input type="text"/> Laboratory Air: <input type="text"/> Laboratory Vacuum: <input type="text"/> Utility Compressed Air: <input type="text" value="1"/>				
Plumbing Remarks: <input type="text"/>							Gas Remarks: <input type="text"/>												

**Appendix 1B Minimum Room Requirements**

Room Name:

Program Number(s):

1.	P3.02.04	7.		13.		19.		25.		31.		37.		43.
2.		8.		14.		20.		26.		32.		38.		44.
3.		9.		15.		21.		27.		33.		39.		45.
4.		10.		16.		22.		28.		34.		40.		46.
5.		11.		17.		23.		29.		35.		41.		47.
6.		12.		18.		24.		30.		36.		42.		48.

**ARCHITECTURAL REQUIREMENTS**

<b>WALL AND CEILING</b> Wall Material: <input type="text" value="ARGB 1.2m AFF, GB above"/> Finish: <input type="text" value="HPC"/> Ceiling Material: <input type="text" value="MMRGB"/> Finish: <input type="text" value="HPC"/>		<b>WALL PROTECTION</b> Type: <input type="text" value="ESRP"/> <input checked="" type="checkbox"/> Corner Guards <input type="checkbox"/> Hand Rails <input type="checkbox"/> Bed Bumper / Locator Height: <input type="text" value="2185 mm"/> <input type="checkbox"/> Crash Rails <input type="checkbox"/> Chair Rail			<b>GLAZING</b> <input type="checkbox"/> Interior Glazing		<b>FLOORING TYPES</b> Material: <input type="text" value="WSVF"/> Base: <input type="text" value="FCB"/>		<b>ROOM ACCESSORIES</b> <input type="checkbox"/> Coat Hooks <input type="checkbox"/> Ceiling Lift <input checked="" type="checkbox"/> Magnetic Whiteboard <input type="checkbox"/> Mirror <input type="checkbox"/> Infant Change Table <input type="checkbox"/> Privacy Curtain		
--	--	--	--	--	---	--	---	--	---	--	--

- LEGEND:**
- WALL AND CEILING LEGEND:**
- AC Architectural Ceiling
  - ACT Acoustic Ceiling Tile
  - ACT-C Cleanroom
  - ARGB Abuse-Resistant Gypsum Board
  - GB Gypsum Board
  - IRGB Impact-Resistant Gypsum Board
  - KLCT Kitchen Lay-in Ceiling Tile
  - MMRGB Moisture and Mould-Resistant Gypsum Board
  - SACT Security Acoustic Ceiling Tile
- WALL FINISHES LEGEND:**
- EWC Epoxy Wall Coating
  - HPC High Performance Coating
  - PT Paint
- CEILING FINISHES LEGEND:**
- ECC Epoxy Ceiling Coating
  - HPC High Performance Coating
  - PF Prefinished
  - PT Paint
- WALL PROTECTION LEGEND:**
- ESRP Extruded Semi-Rigid PVCu Panel
  - FRL Fibre Reinforced Laminate
  - FRP Fibreglass Reinforced Plastic
  - PVV Protective Vinyl Wallcovering
  - RHIS Rigid High Impact Sheet
  - WSSP Wetwall Solid Surface Panel
  - WVV Wetroom Vinyl Wallcovering
- FLOOR FINISHES LEGEND:**
- CFS Concrete Floor Sealer
  - EFC Epoxy Floor Coating
  - PFC Polyurethane Floor Coating
  - RAF Rubber Athletic Flooring
  - RSF Rubber Sheet Flooring
  - SCF Seamless Cushioned Flooring
  - SDRF Static-Dissipative Rubber Sheet Flooring
  - SDVF Static-Dissipative Vinyl Sheet Flooring
  - VSF Vinyl Sheet Flooring
  - WSVF Wetroom Safety Vinyl Sheet Flooring
- FLOOR BASE LEGEND:**
- FCB Flash Cove Base
  - RB Rubber Base
  - SCF Seamless Cushioned Flooring

**DOORS**

Types:

Type:Qty:	Size (mm):	Material:	Finish:	Side Lt:	Blinds:	Protect.:	Privacy Film:	Function:	Card Reader:	Mag Lock:	Auto Opener:	Hold Open:	Hinges:	Accessory 1:	Accessory 2:	Accessory 3:	Closer:	

Door Remarks:  Security Grille  Anti-barricade strategy

**MILLWORK AND SPECIALTY CASEWORK**

Storage Requirements:

**UPPER UNITS** (U1-U8) **SHELF** (S1)

**LOWER UNITS** (L1-L12) **RECEPTION/TRANSACTION COUNTER / CARE TEAM STATION DESK** (TC1-TC2) **UTILITY SINK AND COUNTER UNIT** (UC1)

**FULL-HEIGHT CABINETS** (C1-C5)

**Legend:**  
 Category 0 - None  
 Category 1 - Low (1% - 4%)  
 Category 2 - Med (5% - 9%)  
 Category 3 - High (10% or Greater)

Category	Min. Length (mm)	Motorized Adjustable Height	Standing Height	Specialty Casework
		<input type="checkbox"/>	<input type="checkbox"/>	<input type="checkbox"/>

**FINISHES**

Full-height Cabinet:   
 Upper Millwork:   
 Countertop:   
 Lower Millwork:   
 Shelf:

Remarks:

**MECHANICAL REQUIREMENTS**

**PLUMBING** (Quantity)

Hand Hygiene Sink:	Lavatory:	Kitchen Sink:	Seamless Kitchen Sink:	Utility / Process Sink:	Scrub Sink:	Floor Sink:

Plumbing Remarks:

**Other Fixtures:**

- Shower
- Tub
- Ice Maker
- Water Closet
- Instantaneous Hot Water
- Eyewash Station
- Eyewash/Shower Station
- Emergency Shower
- Flush Rim Sink
- Floor Drain
- Water Bottle Refill Station

Other:

**MED / NON-MED GASES** (Quantity)

Oxygen:	Medical Air:	Medical Vacuum:	Nitrous Oxide:	CO2:	AGSS:	Nitrogen:	Laboratory Air:	Laboratory Vacuum:	Utility Compressed Air:

Gas Remarks:

**Appendix 1B Minimum Room Requirements**

Room Name:

Program Number(s):

1. P1.06	7.	13.	19.	25.	31.	37.	43.
2.	8.	14.	20.	26.	32.	38.	44.
3.	9.	15.	21.	27.	33.	39.	45.
4.	10.	16.	22.	28.	34.	40.	46.
5.	11.	17.	23.	29.	35.	41.	47.
6.	12.	18.	24.	30.	36.	42.	48.

**ARCHITECTURAL REQUIREMENTS**

<b>WALL AND CEILING</b> Wall Material: <input type="text" value="ARGB 1.2m AFF, GB above"/> Finish: <input type="text" value="HPC"/> Ceiling Material: <input type="text" value="MMRGB"/> Finish: <input type="text" value="HPC"/>	<b>WALL PROTECTION</b> Type: <input type="text" value="ESRP"/> <input checked="" type="checkbox"/> Corner Guards <input type="checkbox"/> Hand Rails <input type="checkbox"/> Bed Bumper / Locator Height: <input type="text" value="2185 mm"/> <input checked="" type="checkbox"/> Crash Rails <input type="checkbox"/> Chair Rail	<b>GLAZING</b> <input checked="" type="checkbox"/> Interior Glazing	<b>FLOORING TYPES</b> Material: <input type="text" value="WSVF"/> Base: <input type="text" value="FCB"/>	<b>ROOM ACCESSORIES</b> <input type="checkbox"/> Coat Hooks <input type="checkbox"/> Ceiling Lift <input type="checkbox"/> Magnetic Whiteboard <input type="checkbox"/> Mirror <input type="checkbox"/> Infant Change Table <input type="checkbox"/> Privacy Curtain
--	---	--	---	--

- LEGEND:**
- WALL AND CEILING LEGEND:**
- AC Architectural Ceiling
  - ACT Acoustic Ceiling Tile
  - ACT-C Cleanroom
  - ARGB Abuse-Resistant Gypsum Board
  - GB Gypsum Board
  - IRGB Impact-Resistant Gypsum Board
  - KLCT Kitchen Lay-in Ceiling Tile
  - MMRGB Moisture and Mould-Resistant Gypsum Board
  - SACT Security Acoustic Ceiling Tile
- WALL FINISHES LEGEND:**
- EWC Epoxy Wall Coating
  - HPC High Performance Coating
  - PT Paint
- CEILING FINISHES LEGEND:**
- ECC Epoxy Ceiling Coating
  - HPC High Performance Coating
  - PF Prefinished
  - PT Paint
- WALL PROTECTION LEGEND:**
- ESRP Extruded Semi-Rigid PVCu Panel
  - FRL Fibre Reinforced Laminat
  - FRP Fibreglass Reinforced Plastic
  - PVV Protective Vinyl Wallcovering
  - RHIS Rigid High Impact Sheet
  - WSSP Wetwall Solid Surface Panel
  - WVV Wetroom Vinyl Wallcovering
- FLOOR FINISHES LEGEND:**
- CFS Concrete Floor Sealer
  - EFC Epoxy Floor Coating
  - PFC Polyurethane Floor Coating
  - RAF Rubber Athletic Flooring
  - RSF Rubber Sheet Flooring
  - SCF Seamless Cushioned Flooring
  - SDRF Static-Dissipative Rubber Sheet Flooring
  - SDVF Static-Dissipative Vinyl Sheet Flooring
  - VSF Vinyl Sheet Flooring
  - WSVF Wetroom Safety Vinyl Sheet Flooring
- FLOOR BASE LEGEND:**
- FCB Flash Cove Base
  - RB Rubber Base
  - SCF Seamless Cushioned Flooring

**DOORS**

Types:

Type	Qty	Size (mm)	Material	Finish	Side Lt.	Blinds	Protect.	Privacy Film	Function	Card Reader	Mag Lock	Auto Opener	Hold Open	Hinges	Accessory 1	Accessory 2	Accessory 3	Closer
B	1	1220 x 2135	Solid Core	FRL	<input type="checkbox"/>	<input type="checkbox"/>	2 High	<input type="checkbox"/>	Push/Pull	<input checked="" type="checkbox"/>	<input checked="" type="checkbox"/>	<input checked="" type="checkbox"/>	<input type="checkbox"/>	Cont. Swing Clear	Elec. Strike			Surface
B	1	1220 x 2135	Solid Core	FRL	<input type="checkbox"/>	<input type="checkbox"/>	2 High	<input type="checkbox"/>	Push/Pull	<input type="checkbox"/>	<input checked="" type="checkbox"/>	<input checked="" type="checkbox"/>	<input type="checkbox"/>	Cont. Swing Clear	Elec. Strike			Surface

Door Remarks:

Security Grille  
 Anti-barricade strategy

**MILLWORK AND SPECIALTY CASEWORK**

Storage Requirements:

**FINISHES**

Full-height Cabinet:

Upper Millwork:

Countertop:

Lower Millwork:

Shelf:

Remarks:

**Legend:**

Category	Min. Length (mm)	Motorized Adjustable Height	Standing Height	Specialty Casework
Category 0 - None		<input type="checkbox"/>	<input type="checkbox"/>	<input type="checkbox"/>
Category 1 - Low (1% - 4%)		<input type="checkbox"/>	<input type="checkbox"/>	<input type="checkbox"/>
Category 2 - Med (5% - 9%)		<input type="checkbox"/>	<input type="checkbox"/>	<input type="checkbox"/>
Category 3 - High (10% or Greater)		<input type="checkbox"/>	<input type="checkbox"/>	<input type="checkbox"/>

**MECHANICAL REQUIREMENTS**

<b>PLUMBING</b> (Quantity) Hand Hygiene Sink: <input type="text"/> Lavatory: <input type="text"/> Kitchen Sink: <input type="text"/> Seamless Kitchen Sink: <input type="text"/> Utility / Process Sink: <input type="text"/> Scrub Sink: <input type="text"/> Floor Sink: <input type="text"/> Plumbing Remarks: <input type="text"/>	Other Fixtures: <input type="checkbox"/> Shower <input type="checkbox"/> Tub <input type="checkbox"/> Ice Maker <input type="checkbox"/> Water Closet <input type="checkbox"/> Instantaneous Hot Water <input type="checkbox"/> Eyewash Station <input type="checkbox"/> Eyewash/Shower Station <input type="checkbox"/> Emergency Shower <input type="checkbox"/> Flush Rim Sink <input type="checkbox"/> Floor Drain <input type="checkbox"/> Water Bottle Refill Station Other: <input type="text"/>	<b>MED / NON-MED GASES</b> (Quantity) Oxygen: <input type="text"/> Medical Air: <input type="text"/> Medical Vacuum: <input type="text"/> Nitrous Oxide: <input type="text"/> CO2: <input type="text"/> AGSS: <input type="text"/> Nitrogen: <input type="text"/> Laboratory Air: <input type="text"/> Laboratory Vacuum: <input type="text"/> Utility Compressed Air: <input type="text"/> Gas Remarks: <input type="text"/>
---	---	---



**Appendix 1B Minimum Room Requirements**

Room Name:

Program Number(s):

1.	P2.05	7.		13.		19.		25.		31.		37.		43.
2.		8.		14.		20.		26.		32.		38.		44.
3.		9.		15.		21.		27.		33.		39.		45.
4.		10.		16.		22.		28.		34.		40.		46.
5.		11.		17.		23.		29.		35.		41.		47.
6.		12.		18.		24.		30.		36.		42.		48.

**ARCHITECTURAL REQUIREMENTS**

<b>WALL AND CEILING</b> Wall Material: <input type="text" value="ARGB"/> Finish: <input type="text" value="PT"/> Ceiling Material: <input type="text" value="ACT"/> Finish: <input type="text" value="PF"/>	<b>WALL PROTECTION</b> Type: <input type="text" value="RHIS"/> <input checked="" type="checkbox"/> Corner Guards <input type="checkbox"/> Hand Rails <input type="checkbox"/> Bed Bumper / Locator Height: <input type="text" value="2480 mm"/> <input type="checkbox"/> Crash Rails <input type="checkbox"/> Chair Rail	<b>GLAZING</b> <input type="checkbox"/> Interior Glazing	<b>FLOORING TYPES</b> Material: <input type="text" value="WSVF"/> Base: <input type="text" value="FCB"/>	<b>ROOM ACCESSORIES</b> <input checked="" type="checkbox"/> Coat Hooks <input type="checkbox"/> Ceiling Lift <input checked="" type="checkbox"/> Magnetic Whiteboard <input type="checkbox"/> Mirror <input type="checkbox"/> Infant Change Table <input type="checkbox"/> Privacy Curtain
---	--	---	---	--

- LEGEND:**
- WALL AND CEILING LEGEND:**
- AC Architectural Ceiling
  - ACT Acoustic Ceiling Tile
  - ACT-C Cleanroom
  - ARGB Abuse-Resistant Gypsum Board
  - GB Gypsum Board
  - IRGB Impact-Resistant Gypsum Board
  - KLCT Kitchen Lay-in Ceiling Tile
  - MMRGB Moisture and Mould-Resistant Gypsum Board
  - SACT Security Acoustic Ceiling Tile
- WALL FINISHES LEGEND:**
- EWC Epoxy Wall Coating
  - HPC High Performance Coating
  - PT Paint
- CEILING FINISHES LEGEND:**
- ECC Epoxy Ceiling Coating
  - HPC High Performance Coating
  - PF Prefinished
  - PT Paint
- WALL PROTECTION LEGEND:**
- ESRP Extruded Semi-Rigid PVCu Panel
  - FRL Fibre Reinforced Laminate
  - FRP Fibreglass Reinforced Plastic
  - PVVW Protective Vinyl Wallcovering
  - RHIS Rigid High Impact Sheet
  - WSSP Wetwall Solid Surface Panel
  - WVVW Wetroom Vinyl Wallcovering
- FLOOR FINISHES LEGEND:**
- CFS Concrete Floor Sealer
  - EFC Epoxy Floor Coating
  - PFC Polyurethane Floor Coating
  - RAF Rubber Athletic Flooring
  - RSF Rubber Sheet Flooring
  - SCF Seamless Cushioned Flooring
  - SDRF Static-Dissipative Rubber Sheet Flooring
  - SDVF Static-Dissipative Vinyl Sheet Flooring
  - VSF Vinyl Sheet Flooring
  - WSVF Wetroom Safety Vinyl Sheet Flooring
- FLOOR BASE LEGEND:**
- FCB Flash Cove Base
  - RB Rubber Base
  - SCF Seamless Cushioned Flooring

**DOORS**

Types:

Type	Qty	Size (mm)	Material	Finish	Side Lt.	Blinds	Protect.	Privacy Film	Function	Card Reader	Mag Lock	Auto Opener	Hold Open	Hinges	Accessory 1	Accessory 2	Accessory 3	Closer
C	2	1220 x 2440	Hollow Metal	Paint	<input type="checkbox"/>	<input type="checkbox"/>	2 High	<input type="checkbox"/>	Storeroom	<input checked="" type="checkbox"/>	<input type="checkbox"/>	<input type="checkbox"/>	<input checked="" type="checkbox"/>	Cont. Swing Clear				Surface

Door Remarks:  Security Grille  Anti-barricade strategy

**MILLWORK AND SPECIALTY CASEWORK**

Storage Requirements:

**UPPER UNITS** (U1-U8) **SHELF** (S1)

**FULL-HEIGHT CABINETS** (C1-C5) **LOWER UNITS** (L1-L12) **RECEPTION/TRANSACTION COUNTER / CARE TEAM STATION DESK** (TC1-TC2) **UTILITY SINK AND COUNTER UNIT** (UC1)

Category	Min. Length (mm)	Motorized Adjustable Height	Standing Height	Specialty Casework
1	900	<input checked="" type="checkbox"/>	<input checked="" type="checkbox"/>	<input type="checkbox"/>

**FINISHES**

Full-height Cabinet:   
 Upper Millwork:   
 Countertop:   
 Lower Millwork:   
 Shelf:

Remarks:

**MECHANICAL REQUIREMENTS**

<b>PLUMBING</b> (Quantity) Hand Hygiene Sink: <input type="text" value="1"/> Lavatory: <input type="text"/> Kitchen Sink: <input type="text"/> Seamless Kitchen Sink: <input type="text"/> Utility / Process Sink: <input type="text"/> Scrub Sink: <input type="text"/> Floor Sink: <input type="text"/> Plumbing Remarks: <input type="text"/>	Other Fixtures: <input type="checkbox"/> Shower <input type="checkbox"/> Tub <input type="checkbox"/> Ice Maker <input type="checkbox"/> Water Closet <input type="checkbox"/> Instantaneous Hot Water <input type="checkbox"/> Ewewash Station <input type="checkbox"/> Eyewash/Shower Station <input type="checkbox"/> Emergency Shower <input type="checkbox"/> Flush Rim Sink <input type="checkbox"/> Floor Drain <input type="checkbox"/> Water Bottle Refill Station Other: <input type="text"/>	<b>MED / NON-MED GASES</b> (Quantity) Oxygen: <input type="text"/> Medical Air: <input type="text"/> Medical Vacuum: <input type="text"/> Nitrous Oxide: <input type="text"/> CO2: <input type="text"/> AGSS: <input type="text"/> Nitrogen: <input type="text"/> Laboratory Air: <input type="text"/> Laboratory Vacuum: <input type="text"/> Utility Compressed Air: <input type="text"/> Gas Remarks: <input type="text"/>
--	--	---

---

# New Surrey Hospital & BC Cancer Centre

MINIMUM ROOM REQUIREMENTS

## Q. Patient Transfer & Portering

---

**Appendix 1B Minimum Room Requirements**

Room Name:

Program Number(s):

1. Q2.04	7.	13.	19.	25.	31.	37.	43.
2.	8.	14.	20.	26.	32.	38.	44.
3.	9.	15.	21.	27.	33.	39.	45.
4.	10.	16.	22.	28.	34.	40.	46.
5.	11.	17.	23.	29.	35.	41.	47.
6.	12.	18.	24.	30.	36.	42.	48.

**ARCHITECTURAL REQUIREMENTS**

<b>WALL AND CEILING</b> Wall Material: <input type="text" value="MMRGB"/> Finish: <input type="text" value="EWC"/> Ceiling Material: <input type="text" value="ACT"/> Finish: <input type="text" value="PF"/>	<b>WALL PROTECTION</b> Type: <input type="text" value="ESRP"/> <input checked="" type="checkbox"/> Corner Guards <input type="checkbox"/> Hand Rails <input type="checkbox"/> Bed Bumper / Locator Height: <input type="text" value="2185 mm"/> <input type="checkbox"/> Crash Rails <input type="checkbox"/> Chair Rail	<b>GLAZING</b> <input checked="" type="checkbox"/> Interior Glazing	<b>FLOORING TYPES</b> Material: <input type="text" value="VSF"/> Base: <input type="text" value="FCB"/>	<b>ROOM ACCESSORIES</b> <input type="checkbox"/> Coat Hooks <input type="checkbox"/> Ceiling Lift <input type="checkbox"/> Magnetic Whiteboard <input type="checkbox"/> Mirror <input type="checkbox"/> Infant Change Table <input type="checkbox"/> Privacy Curtain
---	--	--	--	--

- LEGEND:**
- WALL AND CEILING LEGEND:**
- AC Architectural Ceiling
  - ACT Acoustic Ceiling Tile
  - ACT-C Cleanroom
  - ARGB Abuse-Resistant Gypsum Board
  - GB Gypsum Board
  - IRGB Impact-Resistant Gypsum Board
  - KLCT Kitchen Lay-in Ceiling Tile
  - MMRGB Moisture and Mould-Resistant Gypsum Board
  - SACT Security Acoustic Ceiling Tile
- WALL FINISHES LEGEND:**
- EWC Epoxy Wall Coating
  - HPC High Performance Coating
  - PT Paint
- CEILING FINISHES LEGEND:**
- ECC Epoxy Ceiling Coating
  - HPC High Performance Coating
  - PF Prefinished
  - PT Paint
- WALL PROTECTION LEGEND:**
- ESRP Extruded Semi-Rigid PVCu Panel
  - FRL Fibre Reinforced Laminate
  - FRP Fibreglass Reinforced Plastic
  - PVV Protective Vinyl Wallcovering
  - RHIS Rigid High Impact Sheet
  - WSSP Wetwall Solid Surface Panel
  - WVV Wetroom Vinyl Wallcovering
- FLOOR FINISHES LEGEND:**
- CFS Concrete Floor Sealer
  - EFC Epoxy Floor Coating
  - PFC Polyurethane Floor Coating
  - RAF Rubber Athletic Flooring
  - RSF Rubber Sheet Flooring
  - SCF Seamless Cushioned Flooring
  - SDRF Static-Dissipative Rubber Sheet Flooring
  - SDVF Static-Dissipative Vinyl Sheet Flooring
  - VSF Vinyl Sheet Flooring
  - WSVF Wetroom Safety Vinyl Sheet Flooring
- FLOOR BASE LEGEND:**
- FCB Flash Cove Base
  - RB Rubber Base
  - SCF Seamless Cushioned Flooring

**DOORS**

Types:

Note: for Type F doors, the door panels will be approximately 465/1065 unless otherwise required by the Authority

Door Remarks:  Security Grille  Anti-barricade strategy

Type	Qty	Size (mm)	Material	Finish	Side Lt.	Blinds	Protect.	Privacy Film	Function	Card Reader	Mag Lock	Auto Opener	Hold Open	Hinges	Accessory 1	Accessory 2	Accessory 3	Closer
F	1	1530 x 2135	Hollow Metal	Paint	<input type="checkbox"/>	<input type="checkbox"/>		<input type="checkbox"/>	Passage	<input type="checkbox"/>	<input type="checkbox"/>	<input type="checkbox"/>	<input checked="" type="checkbox"/>	Butt Hinge	Astragal	Flush Bolt		Surface

**MILLWORK AND SPECIALTY CASEWORK**

Storage Requirements:

**UPPER UNITS** (U1-U8) **SHELF** (S1)

**LOWER UNITS** (L1-L12) **RECEPTION/TRANSACTION COUNTER / CARE TEAM STATION DESK** (TC1, TC2) **UTILITY SINK AND COUNTER UNIT** (UC1)

**FULL-HEIGHT CABINETS** (C1-C5)

**Legend:**  
 Category 0 - None  
 Category 1 - Low (1% - 4%)  
 Category 2 - Med (5% - 9%)  
 Category 3 - High (10% or Greater)

Category	Min. Length (mm)	Motorized Adjustable Height	Standing Height	Specialty Casework
<input type="checkbox"/>	<input type="checkbox"/>	<input type="checkbox"/>	<input type="checkbox"/>	<input type="checkbox"/>

**FINISHES**

Full-height Cabinet:   
 Upper Millwork:   
 Countertop:   
 Lower Millwork:   
 Shelf:

Remarks:

**MECHANICAL REQUIREMENTS**

**PLUMBING**

Hand Hygiene Sink:	Lavatory:	Kitchen Sink:	Seamless Kitchen Sink:	Utility / Process Sink:	Scrub Sink:	Floor Sink:
<input type="text"/>	<input type="text"/>	<input type="text"/>	<input type="text"/>	<input type="text"/>	<input type="text"/>	<input type="text"/>

Plumbing Remarks:

**Other Fixtures:**

- Shower
- Tub
- Ice Maker
- Water Closet
- Instantaneous Hot Water
- Eyewash Station
- Eyewash/Shower Station
- Emergency Shower
- Flush Rim Sink
- Floor Drain
- Water Bottle Refill Station

Other:

**MED / NON-MED GASES**

Oxygen:	Medical Air:	Medical Vacuum:	Nitrous Oxide:	CO2:	AGSS:	Nitrogen:	Laboratory Air:	Laboratory Vacuum:	Utility Compressed Air:
<input type="text"/>	<input type="text"/>	<input type="text"/>	<input type="text"/>	<input type="text"/>	<input type="text"/>	<input type="text"/>	<input type="text"/>	<input type="text"/>	<input type="text"/>

Gas Remarks:



**Appendix 1B Minimum Room Requirements**

Room Name:

Program Number(s):

1. Q1.01	7.	13.	19.	25.	31.	37.	43.
2.	8.	14.	20.	26.	32.	38.	44.
3.	9.	15.	21.	27.	33.	39.	45.
4.	10.	16.	22.	28.	34.	40.	46.
5.	11.	17.	23.	29.	35.	41.	47.
6.	12.	18.	24.	30.	36.	42.	48.

**ARCHITECTURAL REQUIREMENTS**

<b>WALL AND CEILING</b> Wall Material: <input type="text" value="MMRGB"/> Finish: <input type="text" value="EWC"/> Ceiling Material: <input type="text" value="ACT"/> Finish: <input type="text" value="PF"/>	<b>WALL PROTECTION</b> Type: <input type="text" value="ESRP"/> <input checked="" type="checkbox"/> Corner Guards <input type="checkbox"/> Hand Rails <input type="checkbox"/> Bed Bumper / Locator Height: <input type="text" value="2185 mm"/> <input type="checkbox"/> Crash Rails <input type="checkbox"/> Chair Rail	<b>GLAZING</b> <input checked="" type="checkbox"/> Interior Glazing	<b>FLOORING TYPES</b> Material: <input type="text" value="VSF"/> Base: <input type="text" value="FCB"/>	<b>ROOM ACCESSORIES</b> <input type="checkbox"/> Coat Hooks <input type="checkbox"/> Ceiling Lift <input type="checkbox"/> Magnetic Whiteboard <input type="checkbox"/> Mirror <input type="checkbox"/> Infant Change Table <input type="checkbox"/> Privacy Curtain
---	--	--	--	--

- LEGEND:**
- WALL AND CEILING LEGEND:**
- AC Architectural Ceiling
  - ACT Acoustic Ceiling Tile
  - ACT-C Cleanroom
  - ARGB Abuse-Resistant Gypsum Board
  - GB Gypsum Board
  - IRGB Impact-Resistant Gypsum Board
  - KLCT Kitchen Lay-in Ceiling Tile
  - MMRGB Moisture and Mould-Resistant Gypsum Board
  - SACT Security Acoustic Ceiling Tile
- WALL FINISHES LEGEND:**
- EWC Epoxy Wall Coating
  - HPC High Performance Coating
  - PT Paint
- CEILING FINISHES LEGEND:**
- ECC Epoxy Ceiling Coating
  - HPC High Performance Coating
  - PF Prefinished
  - PT Paint
- WALL PROTECTION LEGEND:**
- ESRP Extruded Semi-Rigid PVCu Panel
  - FRL Fibre Reinforced Laminate
  - FRP Fibreglass Reinforced Plastic
  - PVV Protective Vinyl Wallcovering
  - RHIS Rigid High Impact Sheet
  - WSSP Wetwall Solid Surface Panel
  - WVV Wetroom Vinyl Wallcovering
- FLOOR FINISHES LEGEND:**
- CFS Concrete Floor Sealer
  - EFC Epoxy Floor Coating
  - PFC Polyurethane Floor Coating
  - RAF Rubber Athletic Flooring
  - RSF Rubber Sheet Flooring
  - SCF Seamless Cushioned Flooring
  - SDRF Static-Dissipative Rubber Sheet Flooring
  - SDVF Static-Dissipative Vinyl Sheet Flooring
  - VSF Vinyl Sheet Flooring
  - WSVF Wetroom Safety Vinyl Sheet Flooring
- FLOOR BASE LEGEND:**
- FCB Flash Cove Base
  - RB Rubber Base
  - SCF Seamless Cushioned Flooring

**DOORS**

Types:

Type	Qty	Size (mm)	Material	Finish	Side Lt.	Blinds	Protect.	Privacy Film	Function	Card Reader	Mag Lock	Auto Opener	Hold Open	Hinges	Accessory 1	Accessory 2	Accessory 3	Closer
C2	2	1830 x 2135	Hollow Metal	Paint	<input type="checkbox"/>	<input type="checkbox"/>		<input type="checkbox"/>	Storeroom	<input checked="" type="checkbox"/>	<input type="checkbox"/>	<input checked="" type="checkbox"/>	<input type="checkbox"/>	Butt Hinge	Astragal	Flush Bolt	Elec. Strike	Surface

Door Remarks:  Security Grille  Anti-barricade strategy



**MECHANICAL REQUIREMENTS**

<b>PLUMBING</b> (Quantity) Hand Hygiene Sink: <input type="text"/> Lavatory: <input type="text"/> Kitchen Sink: <input type="text"/> Seamless Kitchen Sink: <input type="text"/> Utility / Process Sink: <input type="text"/> Scrub Sink: <input type="text"/> Floor Sink: <input type="text"/> Plumbing Remarks: <input type="text"/>	Other Fixtures: <input type="checkbox"/> Shower <input type="checkbox"/> Eyewash Station <input type="checkbox"/> Tub <input type="checkbox"/> Eyewash/Shower Station <input type="checkbox"/> Ice Maker <input type="checkbox"/> Emergency Shower <input type="checkbox"/> Water Closet <input type="checkbox"/> Flush Rim Sink <input type="checkbox"/> Instantaneous Hot Water <input type="checkbox"/> Floor Drain <input type="checkbox"/> Water Bottle Refill Station Other: <input type="text"/>	<b>MED / NON-MED GASES</b> (Quantity) Oxygen: <input type="text"/> Medical Air: <input type="text"/> Medical Vacuum: <input type="text"/> Nitrous Oxide: <input type="text"/> CO2: <input type="text"/> AGSS: <input type="text"/> Nitrogen: <input type="text"/> Laboratory Air: <input type="text"/> Laboratory Vacuum: <input type="text"/> Utility Compressed Air: <input type="text"/> Gas Remarks: <input type="text"/>
---	--	---

**Appendix 1B Minimum Room Requirements**

Room Name:

Program Number(s):

1. Q2.05	7.	13.	19.	25.	31.	37.	43.
2.	8.	14.	20.	26.	32.	38.	44.
3.	9.	15.	21.	27.	33.	39.	45.
4.	10.	16.	22.	28.	34.	40.	46.
5.	11.	17.	23.	29.	35.	41.	47.
6.	12.	18.	24.	30.	36.	42.	48.

**ARCHITECTURAL REQUIREMENTS**

<b>WALL AND CEILING</b> Wall Material: <input type="text" value="MMRGB"/> Finish: <input type="text" value="EWC"/> Ceiling Material: <input type="text" value="ACT"/> Finish: <input type="text" value="PF"/>	<b>WALL PROTECTION</b> Type: <input type="text" value="ESRP"/> <input checked="" type="checkbox"/> Corner Guards <input type="checkbox"/> Hand Rails <input type="checkbox"/> Bed Bumper / Locator Height: <input type="text" value="2185 mm"/> <input type="checkbox"/> Crash Rails <input type="checkbox"/> Chair Rail	<b>GLAZING</b> <input checked="" type="checkbox"/> Interior Glazing	<b>FLOORING TYPES</b> Material: <input type="text" value="VSF"/> Base: <input type="text" value="FCB"/>	<b>ROOM ACCESSORIES</b> <input checked="" type="checkbox"/> Coat Hooks <input type="checkbox"/> Ceiling Lift <input type="checkbox"/> Magnetic Whiteboard <input type="checkbox"/> Mirror <input type="checkbox"/> Infant Change Table <input type="checkbox"/> Privacy Curtain
---	--	--	--	---

- LEGEND:**
- WALL AND CEILING LEGEND:**
- AC Architectural Ceiling
  - ACT Acoustic Ceiling Tile
  - ACT-C Cleanroom
  - ARGB Abuse-Resistant Gypsum Board
  - GB Gypsum Board
  - IRGB Impact-Resistant Gypsum Board
  - KLCT Kitchen Lay-in Ceiling Tile
  - MMRGB Moisture and Mould-Resistant Gypsum Board
  - SACT Security Acoustic Ceiling Tile
- WALL FINISHES LEGEND:**
- EWC Epoxy Wall Coating
  - HPC High Performance Coating
  - PT Paint
- CEILING FINISHES LEGEND:**
- ECC Epoxy Ceiling Coating
  - HPC High Performance Coating
  - PF Prefinished
  - PT Paint
- WALL PROTECTION LEGEND:**
- ESRP Extruded Semi-Rigid PVCu Panel
  - FRL Fibre Reinforced Laminate
  - FRP Fibreglass Reinforced Plastic
  - PVV Protective Vinyl Wallcovering
  - RHIS Rigid High Impact Sheet
  - WSSP Wetwall Solid Surface Panel
  - WVV Wetroom Vinyl Wallcovering
- FLOOR FINISHES LEGEND:**
- CFS Concrete Floor Sealer
  - EFC Epoxy Floor Coating
  - PFC Polyurethane Floor Coating
  - RAF Rubber Athletic Flooring
  - RSF Rubber Sheet Flooring
  - SCF Seamless Cushioned Flooring
  - SDRF Static-Dissipative Rubber Sheet Flooring
  - SDVF Static-Dissipative Vinyl Sheet Flooring
  - VSF Vinyl Sheet Flooring
  - WSVF Wetroom Safety Vinyl Sheet Flooring
- FLOOR BASE LEGEND:**
- FCB Flash Cove Base
  - RB Rubber Base
  - SCF Seamless Cushioned Flooring

**DOORS**

Types:

Type	Qty	Size (mm)	Material	Finish	Side Lt.	Blinds	Protect.	Privacy Film	Function	Card Reader	Mag Lock	Auto Opener	Hold Open	Hinges	Accessory 1	Accessory 2	Accessory 3	Closer
B	1	1065 x 2135	Hollow Metal	Paint	<input type="checkbox"/>	<input checked="" type="checkbox"/>		<input type="checkbox"/>	Storeroom	<input checked="" type="checkbox"/>	<input type="checkbox"/>	<input type="checkbox"/>	<input type="checkbox"/>	Butt Hinge				Surface
C	1	915 x 2135	Solid Core	FRL	<input type="checkbox"/>	<input type="checkbox"/>	1 Low	<input checked="" type="checkbox"/>	Storeroom	<input checked="" type="checkbox"/>	<input type="checkbox"/>	<input type="checkbox"/>	<input type="checkbox"/>	Butt Hinge				Surface

**DOOR REMARKS:**  Security Grille  Anti-barricade strategy

**MILLWORK AND SPECIALTY CASEWORK**

**UPPER UNITS:** U1, U2, U3, U4, U5, U6, U7, U8

**LOWER UNITS:** L1, L2, L3, L4, L5, L6, L7, L8, L9, L10, L11, L12

**RECEPTION/TRANSACTION COUNTER / CARE TEAM STATION DESK:** TC1, TC2

**UTILITY SINK AND COUNTER UNIT:** UC1

**SHELF:** S1

**Storage Requirements:**

**FINISHES**

Full-height Cabinet:

Upper Millwork:

Countertop:

Lower Millwork:

Shelf:

**Remarks:** Provide blinds on the Identification Room side of the window

Category	Min. Length (mm)	Motorized Adjustable Height	Standing Height	Specialty Casework
Category 0 - None		<input type="checkbox"/>	<input type="checkbox"/>	<input type="checkbox"/>
Category 1 - Low (1% - 4%)		<input type="checkbox"/>	<input type="checkbox"/>	<input type="checkbox"/>
Category 2 - Med (5% - 9%)		<input type="checkbox"/>	<input type="checkbox"/>	<input type="checkbox"/>
Category 3 - High (10% or Greater)		<input type="checkbox"/>	<input type="checkbox"/>	<input type="checkbox"/>

**MECHANICAL REQUIREMENTS**

<b>PLUMBING</b> (Quantity) Hand Hygiene Sink: <input type="text"/> Lavatory: <input type="text"/> Kitchen Sink: <input type="text"/> Seamless Kitchen Sink: <input type="text"/> Utility / Process Sink: <input type="text"/> Scrub Sink: <input type="text"/> Floor Sink: <input type="text"/> Plumbing Remarks: <input type="text"/>	Other Fixtures: <input type="checkbox"/> Shower <input type="checkbox"/> Eyewash Station <input type="checkbox"/> Tub <input type="checkbox"/> Eyewash/Shower Station <input type="checkbox"/> Ice Maker <input type="checkbox"/> Emergency Shower <input type="checkbox"/> Water Closet <input type="checkbox"/> Flush Rim Sink <input type="checkbox"/> Instantaneous Hot Water <input type="checkbox"/> Floor Drain <input type="checkbox"/> <input type="checkbox"/> Water Bottle Refill Station Other: <input type="text"/>	<b>MED / NON-MED GASES</b> (Quantity) Oxygen: <input type="text"/> Medical Air: <input type="text"/> Medical Vacuum: <input type="text"/> Nitrous Oxide: <input type="text"/> CO2: <input type="text"/> AGSS: <input type="text"/> Nitrogen: <input type="text"/> Laboratory Air: <input type="text"/> Laboratory Vacuum: <input type="text"/> Utility Compressed Air: <input type="text"/> Gas Remarks: <input type="text"/>
---	---	---

**Appendix 1B Minimum Room Requirements**

Room Name:

Program Number(s):

1. Q2.03	7.	13.	19.	25.	31.	37.	43.
2.	8.	14.	20.	26.	32.	38.	44.
3.	9.	15.	21.	27.	33.	39.	45.
4.	10.	16.	22.	28.	34.	40.	46.
5.	11.	17.	23.	29.	35.	41.	47.
6.	12.	18.	24.	30.	36.	42.	48.

**ARCHITECTURAL REQUIREMENTS**

<b>WALL AND CEILING</b> Wall Material: <input type="text" value="MMRGB"/> Finish: <input type="text" value="HPC"/> Ceiling Material: <input type="text" value="ACT"/> Finish: <input type="text" value="PF"/>	<b>WALL PROTECTION</b> Type: <input type="text" value="FRP"/> <input checked="" type="checkbox"/> Corner Guards <input type="checkbox"/> Hand Rails <input type="checkbox"/> Bed Bumper / Locator Height: <input type="text" value="1350 mm"/> <input type="checkbox"/> Crash Rails <input type="checkbox"/> Chair Rail	<b>GLAZING</b> <input type="checkbox"/> Interior Glazing	<b>FLOORING TYPES</b> Material: <input type="text" value="VSF"/> Base: <input type="text" value="FCB"/>	<b>ROOM ACCESSORIES</b> <input type="checkbox"/> Coat Hooks <input checked="" type="checkbox"/> Ceiling Lift <input type="checkbox"/> Magnetic Whiteboard <input type="checkbox"/> Mirror <input type="checkbox"/> Infant Change Table <input type="checkbox"/> Privacy Curtain
---	---	---	--	---

- LEGEND:**
- WALL AND CEILING LEGEND:**
- AC Architectural Ceiling
  - ACT Acoustic Ceiling Tile
  - ACT-C Cleanroom
  - ARGB Abuse-Resistant Gypsum Board
  - GB Gypsum Board
  - IRGB Impact-Resistant Gypsum Board
  - KLCT Kitchen Lay-in Ceiling Tile
  - MMRGB Moisture and Mould-Resistant Gypsum Board
  - SACT Security Acoustic Ceiling Tile
- WALL FINISHES LEGEND:**
- EWC Epoxy Wall Coating
  - HPC High Performance Coating
  - PT Paint
- CEILING FINISHES LEGEND:**
- ECC Epoxy Ceiling Coating
  - HPC High Performance Coating
  - PF Prefinished
  - PT Paint
- WALL PROTECTION LEGEND:**
- ESRP Extruded Semi-Rigid PVCu Panel
  - FRL Fibre Reinforced Laminate
  - FRP Fibreglass Reinforced Plastic
  - PVV Protective Vinyl Wallcovering
  - RHIS Rigid High Impact Sheet
  - WSSP Wetwall Solid Surface Panel
  - WVV Wetroom Vinyl Wallcovering
- FLOOR FINISHES LEGEND:**
- CFS Concrete Floor Sealer
  - EFC Epoxy Floor Coating
  - PFC Polyurethane Floor Coating
  - RAF Rubber Athletic Flooring
  - RSF Rubber Sheet Flooring
  - SCF Seamless Cushioned Flooring
  - SDRF Static-Dissipative Rubber Sheet Flooring
  - SDVF Static-Dissipative Vinyl Sheet Flooring
  - VSF Vinyl Sheet Flooring
  - WSVF Wetroom Safety Vinyl Sheet Flooring
- FLOOR BASE LEGEND:**
- FCB Flash Cove Base
  - RB Rubber Base
  - SCF Seamless Cushioned Flooring

**DOORS**

Types:

Type	Qty	Size (mm)	Material	Finish	Side Lt.	Blinds	Protect.	Privacy Film	Function	Card Reader	Mag Lock	Auto Opener	Hold Open	Hinges	Accessory 1	Accessory 2	Accessory 3	Closer
B2	1	1830 x 2135	Solid Core	FRL	<input type="checkbox"/>	<input type="checkbox"/>		<input type="checkbox"/>	Storeroom	<input type="checkbox"/>	<input type="checkbox"/>	<input checked="" type="checkbox"/>	<input type="checkbox"/>	Cont. Swing Clear	Astragal	Flush Bolt	Elec. Strike	Surface

**DOOR REMARKS:**

Security Grille  
 Anti-barricade strategy

**MILLWORK AND SPECIALTY CASEWORK**

**UPPER UNITS:** U1, U2, U3, U4, U5, U6, U7, U8

**LOWER UNITS:** L1, L2, L3, L4, L5, L6, L7, L8, L9, L10, L11, L12

**RECEPTION/TRANSACTION COUNTER / CARE TEAM STATION DESK:** TC1, TC2

**UTILITY SINK AND COUNTER UNIT:** UC1

**SHELF:** S1

**Storage Requirements:**

**FINISHES**

Full-height Cabinet:   
 Upper Millwork:   
 Countertop:   
 Lower Millwork:   
 Shelf:

**Remarks:**

Refer to Schedule 1, Section 13 21 00 - Walk-in Refrigerators and Cold Rooms

**MECHANICAL REQUIREMENTS**

<b>PLUMBING</b> (Quantity) Hand Hygiene Sink: <input type="text"/> Lavatory: <input type="text"/> Kitchen Sink: <input type="text"/> Seamless Kitchen Sink: <input type="text"/> Utility / Process Sink: <input type="text"/> Scrub Sink: <input type="text"/> Floor Sink: <input type="text"/> Plumbing Remarks: <input type="text" value="Provide floor drain outside of walk in cooler."/>	Other Fixtures: <input type="checkbox"/> Shower <input type="checkbox"/> Tub <input type="checkbox"/> Ice Maker <input type="checkbox"/> Water Closet <input type="checkbox"/> Instantaneous Hot Water <input type="checkbox"/> Eyewash Station <input type="checkbox"/> Eyewash/Shower Station <input type="checkbox"/> Emergency Shower <input type="checkbox"/> Flush Rim Sink <input checked="" type="checkbox"/> Floor Drain <input type="checkbox"/> Water Bottle Refill Station Other: <input type="text"/>	<b>MED / NON-MED GASES</b> (Quantity) Oxygen: <input type="text"/> Medical Air: <input type="text"/> Medical Vacuum: <input type="text"/> Nitrous Oxide: <input type="text"/> CO2: <input type="text"/> AGSS: <input type="text"/> Nitrogen: <input type="text"/> Laboratory Air: <input type="text"/> Laboratory Vacuum: <input type="text"/> Utility Compressed Air: <input type="text"/> Gas Remarks: <input type="text"/>
--	--	---



**Appendix 1B Minimum Room Requirements**

Room Name:

Program Number(s):

1. Q2.02	7.	13.	19.	25.	31.	37.	43.
2.	8.	14.	20.	26.	32.	38.	44.
3.	9.	15.	21.	27.	33.	39.	45.
4.	10.	16.	22.	28.	34.	40.	46.
5.	11.	17.	23.	29.	35.	41.	47.
6.	12.	18.	24.	30.	36.	42.	48.

**ARCHITECTURAL REQUIREMENTS**

<b>WALL AND CEILING</b> Wall Material: <input type="text" value="ARGB 1.2m AFF, GB above"/> Finish: <input type="text" value="PT"/> Ceiling Material: <input type="text" value="ACT"/> Finish: <input type="text" value="PF"/>		<b>WALL PROTECTION</b> Type: <input type="text" value="RHIS"/> <input checked="" type="checkbox"/> Corner Guards <input type="checkbox"/> Hand Rails <input type="checkbox"/> Bed Bumper / Locator Height: <input type="text" value="1350 mm"/> <input checked="" type="checkbox"/> Crash Rails <input type="checkbox"/> Chair Rail		<b>GLAZING</b> <input type="checkbox"/> Interior Glazing		<b>FLOORING TYPES</b> Material: <input type="text" value="WSVF"/> Base: <input type="text" value="FCB"/>		<b>ROOM ACCESSORIES</b> <input checked="" type="checkbox"/> Coat Hooks <input checked="" type="checkbox"/> Ceiling Lift <input type="checkbox"/> Magnetic Whiteboard <input type="checkbox"/> Mirror <input type="checkbox"/> Infant Change Table <input type="checkbox"/> Privacy Curtain	
--	--	---	--	---	--	---	--	--	--

- LEGEND:**
- WALL AND CEILING LEGEND:**
- AC Architectural Ceiling
  - ACT Acoustic Ceiling Tile
  - ACT-C Cleanroom
  - ARGB Abuse-Resistant Gypsum Board
  - GB Gypsum Board
  - IRGB Impact-Resistant Gypsum Board
  - KLCT Kitchen Lay-in Ceiling Tile
  - MMRGB Moisture and Mould-Resistant Gypsum Board
  - SACT Security Acoustic Ceiling Tile
- WALL FINISHES LEGEND:**
- EWC Epoxy Wall Coating
  - HPC High Performance Coating
  - PT Paint
- CEILING FINISHES LEGEND:**
- ECC Epoxy Ceiling Coating
  - HPC High Performance Coating
  - PF Prefinished
  - PT Paint
- WALL PROTECTION LEGEND:**
- ESRP Extruded Semi-Rigid PVCu Panel
  - FRL Fibre Reinforced Laminate
  - FRP Fibreglass Reinforced Plastic
  - PVV Protective Vinyl Wallcovering
  - RHIS Rigid High Impact Sheet
  - WSSP Wetwall Solid Surface Panel
  - WVV Wetroom Vinyl Wallcovering
- FLOOR FINISHES LEGEND:**
- CFS Concrete Floor Sealer
  - EFC Epoxy Floor Coating
  - PFC Polyurethane Floor Coating
  - RAF Rubber Athletic Flooring
  - RSF Rubber Sheet Flooring
  - SCF Seamless Cushioned Flooring
  - SDRF Static-Dissipative Rubber Sheet Flooring
  - SDVF Static-Dissipative Vinyl Sheet Flooring
  - VSF Vinyl Sheet Flooring
  - WSVF Wetroom Safety Vinyl Sheet Flooring
- FLOOR BASE LEGEND:**
- FCB Flash Cove Base
  - RB Rubber Base
  - SCF Seamless Cushioned Flooring

**DOORS**

Types:

Type:Qty:	Size (mm):	Material:	Finish:	Side Lt:	Blinds:	Protect.:	Privacy Film:	Function:	Card Reader:	Mag Lock:	Auto Opener:	Hold Open:	Hinges:	Accessory 1:	Accessory 2:	Accessory 3:	Closer:

Door Remarks:  Security Grille  Anti-barricade strategy

**MILLWORK AND SPECIALTY CASEWORK**

**UPPER UNITS** (U1-U8) **LOWER UNITS** (L1-L12) **RECEPTION/TRANSACTION COUNTER / CARE TEAM STATION DESK** (TC1-TC2) **UTILITY SINK AND COUNTER UNIT** (UC1)

Storage Requirements:

**FINISHES**

Full-height Cabinet:

Upper Millwork:

Countertop:

Lower Millwork:

Shelf:

Remarks:

Category	Min. Length (mm)	Motorized Adjustable Height	Standing Height	Specialty Casework
1	900	<input type="checkbox"/>	<input type="checkbox"/>	<input type="checkbox"/>

**MECHANICAL REQUIREMENTS**

<b>PLUMBING</b> (Quantity)		Hand Hygiene Sink: <input type="text" value="1"/>	Lavatory: <input type="text"/>	Kitchen Sink: <input type="text"/>	Seamless Kitchen Sink: <input type="text"/>	Utility / Process Sink: <input type="text" value="1"/>	Scrub Sink: <input type="text"/>	Floor Sink: <input type="text"/>	Other Fixtures: <input type="checkbox"/> Shower <input type="checkbox"/> Tub <input type="checkbox"/> Ice Maker <input type="checkbox"/> Water Closet <input type="checkbox"/> Instantaneous Hot Water	<input checked="" type="checkbox"/> Eyewash Station <input type="checkbox"/> Eyewash/Shower Station <input type="checkbox"/> Emergency Shower <input type="checkbox"/> Flush Rim Sink <input checked="" type="checkbox"/> Floor Drain <input type="checkbox"/> Water Bottle Refill Station Other: <input type="text"/>	<b>MED / NON-MED GASES</b> (Quantity)	Oxygen: <input type="text"/>	Medical Air: <input type="text"/>	Medical Vacuum: <input type="text"/>	Nitrous Oxide: <input type="text"/>	CO2: <input type="text"/>	AGSS: <input type="text"/>	Nitrogen: <input type="text"/>	Laboratory Air: <input type="text"/>	Laboratory Vacuum: <input type="text"/>	Utility Compressed Air: <input type="text"/>
Plumbing Remarks: <input type="text"/>		Gas Remarks: <input type="text"/>																			

---

# New Surrey Hospital & BC Cancer Centre

MINIMUM ROOM REQUIREMENTS

## R. Pharmacy Services

---

**Appendix 1B Minimum Room Requirements**

Room Name:

Program Number(s):

1. R1.02.04	7.	13.	19.	25.	31.	37.	43.
2.	8.	14.	20.	26.	32.	38.	44.
3.	9.	15.	21.	27.	33.	39.	45.
4.	10.	16.	22.	28.	34.	40.	46.
5.	11.	17.	23.	29.	35.	41.	47.
6.	12.	18.	24.	30.	36.	42.	48.

**ARCHITECTURAL REQUIREMENTS**

<b>WALL AND CEILING</b> Wall Material: <input type="text" value="ARGB 1.2m AFF, GB above"/> Finish: <input type="text" value="EWC"/> Ceiling Material: <input type="text" value="ACT"/> Finish: <input type="text" value="PF"/>	<b>WALL PROTECTION</b> Type: <input type="text" value="ESRP"/> <input checked="" type="checkbox"/> Corner Guards <input type="checkbox"/> Hand Rails <input type="checkbox"/> Bed Bumper / Locator Height: <input type="text" value="2185 mm"/> <input checked="" type="checkbox"/> Crash Rails <input type="checkbox"/> Chair Rail	<b>GLAZING</b> <input type="checkbox"/> Interior Glazing	<b>FLOORING TYPES</b> Material: <input type="text" value="VSF"/> Base: <input type="text" value="FCB"/>	<b>ROOM ACCESSORIES</b> <input type="checkbox"/> Coat Hooks <input type="checkbox"/> Ceiling Lift <input type="checkbox"/> Magnetic Whiteboard <input type="checkbox"/> Mirror <input type="checkbox"/> Infant Change Table <input type="checkbox"/> Privacy Curtain
---	---	---	--	--

- LEGEND:**
- WALL AND CEILING LEGEND:**
- AC Architectural Ceiling
  - ACT Acoustic Ceiling Tile
  - ACT-C Cleanroom
  - ARGB Abuse-Resistant Gypsum Board
  - GB Gypsum Board
  - IRGB Impact-Resistant Gypsum Board
  - KLCT Kitchen Lay-in Ceiling Tile
  - MMRGB Moisture and Mould-Resistant Gypsum Board
  - SACT Security Acoustic Ceiling Tile
- WALL FINISHES LEGEND:**
- EWC Epoxy Wall Coating
  - HPC High Performance Coating
  - PT Paint
- CEILING FINISHES LEGEND:**
- ECC Epoxy Ceiling Coating
  - HPC High Performance Coating
  - PF Prefinished
  - PT Paint
- WALL PROTECTION LEGEND:**
- ESRP Extruded Semi-Rigid PVCu Panel
  - FRL Fibre Reinforced Laminate
  - FRP Fibreglass Reinforced Plastic
  - PVV Protective Vinyl Wallcovering
  - RHIS Rigid High Impact Sheet
  - WSSP Wetwall Solid Surface Panel
  - WVV Wetroom Vinyl Wallcovering
- FLOOR FINISHES LEGEND:**
- CFS Concrete Floor Sealer
  - EFC Epoxy Floor Coating
  - PFC Polyurethane Floor Coating
  - RAF Rubber Athletic Flooring
  - RSF Rubber Sheet Flooring
  - SCF Seamless Cushioned Flooring
  - SDRF Static-Dissipative Rubber Sheet Flooring
  - SDVF Static-Dissipative Vinyl Sheet Flooring
  - VSF Vinyl Sheet Flooring
  - WSVF Wetroom Safety Vinyl Sheet Flooring
- FLOOR BASE LEGEND:**
- FCB Flash Cove Base
  - RB Rubber Base
  - SCF Seamless Cushioned Flooring

**DOORS**

Types:

Type	Qty	Size (mm)	Material	Finish	Side Lt.	Blinds	Protect.	Privacy Film	Function	Card Reader	Mag Lock	Auto Opener	Hold Open	Hinges	Accessory 1	Accessory 2	Accessory 3	Closer
C	1	1220 x 2135	Solid Core	FRL	<input type="checkbox"/>	<input type="checkbox"/>	2 High	<input checked="" type="checkbox"/>	Storeroom	<input checked="" type="checkbox"/>	<input type="checkbox"/>	<input type="checkbox"/>	<input checked="" type="checkbox"/>	Cont. Swing Clear				Surface

**DOOR REMARKS:**

Security Grille  
 Anti-barricade strategy

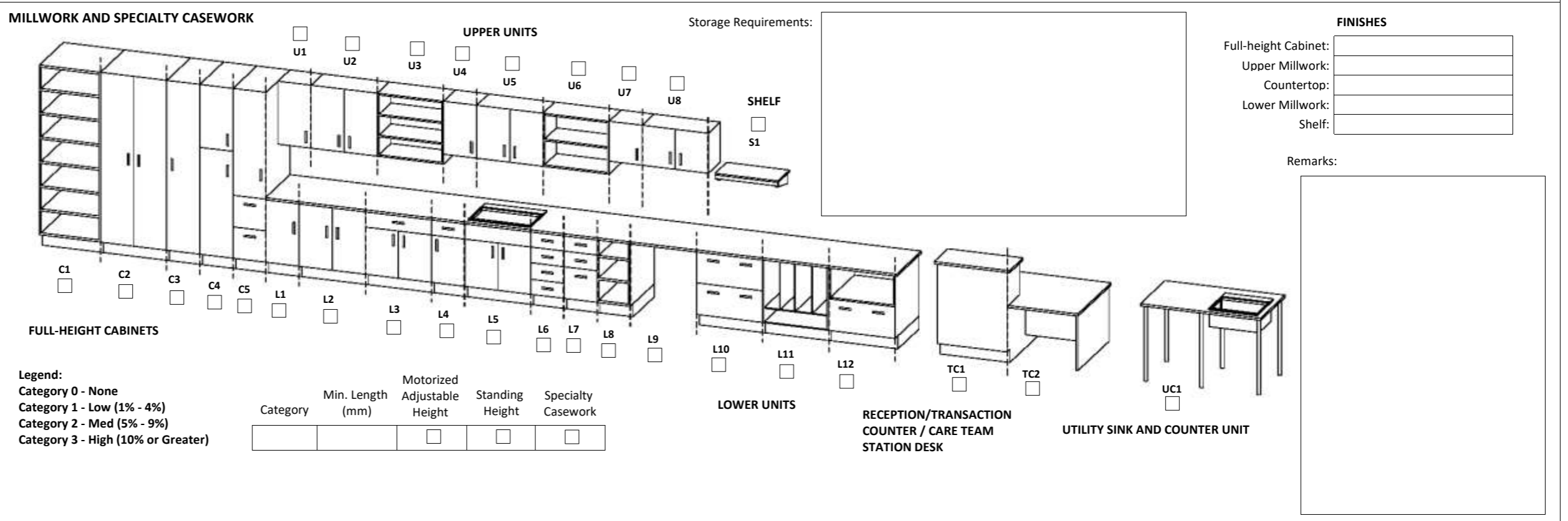

**MECHANICAL REQUIREMENTS**

<b>PLUMBING</b> (Quantity) Hand Hygiene Sink: <input type="text"/> Lavatory: <input type="text"/> Kitchen Sink: <input type="text"/> Kitchen Sink: <input type="text"/> Utility / Process Sink: <input type="text"/> Scrub Sink: <input type="text"/> Floor Sink: <input type="text"/> Plumbing Remarks: <input type="text"/>	Other Fixtures: <input type="checkbox"/> Shower <input type="checkbox"/> Tub <input type="checkbox"/> Ice Maker <input type="checkbox"/> Water Closet <input type="checkbox"/> Instantaneous Hot Water <input type="checkbox"/> Eyewash Station <input type="checkbox"/> Eyewash/Shower Station <input type="checkbox"/> Emergency Shower <input type="checkbox"/> Flush Rim Sink <input type="checkbox"/> Floor Drain <input type="checkbox"/> Water Bottle Refill Station Other: <input type="text"/>	<b>MED / NON-MED GASES</b> (Quantity) Oxygen: <input type="text"/> Medical Air: <input type="text"/> Medical Vacuum: <input type="text"/> Nitrous Oxide: <input type="text"/> CO2: <input type="text"/> AGSS: <input type="text"/> Nitrogen: <input type="text"/> Laboratory Air: <input type="text"/> Laboratory Vacuum: <input type="text"/> Utility Compressed Air: <input type="text"/> Gas Remarks: <input type="text"/>
--	---	---



**Appendix 1B Minimum Room Requirements**

Room Name:

Program Number(s):

1. R3.05	7.	13.	19.	25.	31.	37.	43.
2.	8.	14.	20.	26.	32.	38.	44.
3.	9.	15.	21.	27.	33.	39.	45.
4.	10.	16.	22.	28.	34.	40.	46.
5.	11.	17.	23.	29.	35.	41.	47.
6.	12.	18.	24.	30.	36.	42.	48.

**ARCHITECTURAL REQUIREMENTS**

<b>WALL AND CEILING</b> Wall Material: <input type="text" value="ARGB 1.2m AFF, GB above"/> Finish: <input type="text" value="EWC"/> Ceiling Material: <input type="text" value="GB"/> Finish: <input type="text" value="ECC"/>	<b>WALL PROTECTION</b> Type: <input type="text" value="ESRP"/> <input checked="" type="checkbox"/> Corner Guards <input type="checkbox"/> Hand Rails <input type="checkbox"/> Bed Bumper / Locator Height: <input type="text" value="2185 mm"/> <input type="checkbox"/> Crash Rails <input type="checkbox"/> Chair Rail	<b>GLAZING</b> <input type="checkbox"/> Interior Glazing	<b>FLOORING TYPES</b> Material: <input type="text" value="VSF"/> Base: <input type="text" value="FCB"/>	<b>ROOM ACCESSORIES</b> <input checked="" type="checkbox"/> Coat Hooks <input type="checkbox"/> Ceiling Lift <input type="checkbox"/> Magnetic Whiteboard <input type="checkbox"/> Mirror <input type="checkbox"/> Infant Change Table <input type="checkbox"/> Privacy Curtain
---	--	---	--	---

- LEGEND:**
- WALL AND CEILING LEGEND:**
- AC Architectural Ceiling
  - ACT Acoustic Ceiling Tile
  - ACT-C Cleanroom
  - ARGB Abuse-Resistant Gypsum Board
  - GB Gypsum Board
  - IRGB Impact-Resistant Gypsum Board
  - KLCT Kitchen Lay-in Ceiling Tile
  - MMRGB Moisture and Mould-Resistant Gypsum Board
  - SACT Security Acoustic Ceiling Tile
- WALL FINISHES LEGEND:**
- EWC Epoxy Wall Coating
  - HPC High Performance Coating
  - PT Paint
- CEILING FINISHES LEGEND:**
- ECC Epoxy Ceiling Coating
  - HPC High Performance Coating
  - PF Prefinished
  - PT Paint
- WALL PROTECTION LEGEND:**
- ESRP Extruded Semi-Rigid PVCu Panel
  - FRL Fibre Reinforced Laminate
  - FRP Fibreglass Reinforced Plastic
  - PVV Protective Vinyl Wallcovering
  - RHIS Rigid High Impact Sheet
  - WSSP Wetwall Solid Surface Panel
  - WVV Wetroom Vinyl Wallcovering
- FLOOR FINISHES LEGEND:**
- CFS Concrete Floor Sealer
  - EFC Epoxy Floor Coating
  - PFC Polyurethane Floor Coating
  - RAF Rubber Athletic Flooring
  - RSF Rubber Sheet Flooring
  - SCF Seamless Cushioned Flooring
  - SDRF Static-Dissipative Rubber Sheet Flooring
  - SDVF Static-Dissipative Vinyl Sheet Flooring
  - VSF Vinyl Sheet Flooring
  - WSVF Wetroom Safety Vinyl Sheet Flooring
- FLOOR BASE LEGEND:**
- FCB Flash Cove Base
  - RB Rubber Base
  - SCF Seamless Cushioned Flooring

**DOORS**

Types:

Type	Qty	Size (mm)	Material	Finish	Side Lt.	Blinds	Protect.	Privacy Film	Function	Card Reader	Mag Lock	Auto Opener	Hold Open	Hinges	Accessory 1	Accessory 2	Accessory 3	Closer
B	1	1065 x 2135	Solid Core	FRL	<input type="checkbox"/>	<input type="checkbox"/>	2 High	<input type="checkbox"/>	Passage	<input type="checkbox"/>	<input checked="" type="checkbox"/>	<input checked="" type="checkbox"/>	<input type="checkbox"/>	Butt Hinge	Elec. Strike			Concealed

**Door Remarks:**  
Refer to Appendix 10 for door interlocking requirements. Provide wave openers on door, door and hardware to be high wash compatible.

- Security Grille
- Anti-barricade strategy

**MILLWORK AND SPECIALTY CASEWORK**

**UPPER UNITS** (U1-U8) **LOWER UNITS** (L1-L12) **RECEPTION/TRANSACTION COUNTER / CARE TEAM STATION DESK** (TC1-TC2) **UTILITY SINK AND COUNTER UNIT** (UC1)

**Storage Requirements:**  SHELF (S1)

**FINISHES**

- Full-height Cabinet:
- Upper Millwork:
- Countertop:
- Lower Millwork:
- Shelf:

**Remarks:**  
Provide ceiling hatches with gaskets.

**Legend:**

Category	Min. Length (mm)	Motorized Adjustable Height	Standing Height	Specialty Casework
Category 0 - None		<input type="checkbox"/>	<input type="checkbox"/>	<input type="checkbox"/>
Category 1 - Low (1% - 4%)		<input type="checkbox"/>	<input type="checkbox"/>	<input type="checkbox"/>
Category 2 - Med (5% - 9%)		<input type="checkbox"/>	<input type="checkbox"/>	<input type="checkbox"/>
Category 3 - High (10% or Greater)		<input type="checkbox"/>	<input type="checkbox"/>	<input type="checkbox"/>

**MECHANICAL REQUIREMENTS**

<b>PLUMBING</b> (Quantity) Hand Hygiene Sink: <input type="text"/> Lavatory: <input type="text"/> Kitchen Sink: <input type="text"/> Seamless Kitchen Sink: <input type="text"/> Utility / Process Sink: <input type="text"/> Scrub Sink: <input type="text" value="1"/> Floor Sink: <input type="text"/> Plumbing Remarks: <input type="text"/>	Other Fixtures: <input type="checkbox"/> Shower <input type="checkbox"/> Eyewash Station <input type="checkbox"/> Tub <input type="checkbox"/> Eyewash/Shower Station <input type="checkbox"/> Ice Maker <input type="checkbox"/> Emergency Shower <input type="checkbox"/> Water Closet <input type="checkbox"/> Flush Rim Sink <input type="checkbox"/> Instantaneous Hot Water <input type="checkbox"/> Floor Drain <input type="checkbox"/> <input type="checkbox"/> Water Bottle Refill Station Other <input type="text"/>	<b>MED / NON-MED GASES</b> (Quantity) Oxygen: <input type="text"/> Medical Air: <input type="text"/> Medical Vacuum: <input type="text"/> Nitrous Oxide: <input type="text"/> CO2: <input type="text"/> AGSS: <input type="text"/> Nitrogen: <input type="text"/> Laboratory Air: <input type="text"/> Laboratory Vacuum: <input type="text"/> Utility Compressed Air: <input type="text"/> Gas Remarks: <input type="text"/>
---	--	---

**Appendix 1B Minimum Room Requirements**

Room Name:

Program Number(s):

1. R3.03	7.	13.	19.	25.	31.	37.	43.
2.	8.	14.	20.	26.	32.	38.	44.
3.	9.	15.	21.	27.	33.	39.	45.
4.	10.	16.	22.	28.	34.	40.	46.
5.	11.	17.	23.	29.	35.	41.	47.
6.	12.	18.	24.	30.	36.	42.	48.

**ARCHITECTURAL REQUIREMENTS**

<b>WALL AND CEILING</b> Wall Material: <input type="text" value="ARGB 1.2m AFF, GB above"/> Finish: <input type="text" value="EWC"/> Ceiling Material: <input type="text" value="GB"/> Finish: <input type="text" value="ECC"/>	<b>WALL PROTECTION</b> Type: <input type="text" value="ESRP"/> <input checked="" type="checkbox"/> Corner Guards <input type="checkbox"/> Hand Rails <input type="checkbox"/> Bed Bumper / Locator Height: <input type="text" value="2185 mm"/> <input type="checkbox"/> Crash Rails <input type="checkbox"/> Chair Rail	<b>GLAZING</b> <input type="checkbox"/> Interior Glazing	<b>FLOORING TYPES</b> Material: <input type="text" value="VSF"/> Base: <input type="text" value="FCB"/>	<b>ROOM ACCESSORIES</b> <input checked="" type="checkbox"/> Coat Hooks <input type="checkbox"/> Ceiling Lift <input type="checkbox"/> Magnetic Whiteboard <input type="checkbox"/> Mirror <input type="checkbox"/> Infant Change Table <input type="checkbox"/> Privacy Curtain
---	--	---	--	---

- LEGEND:**
- WALL AND CEILING LEGEND:**
- AC Architectural Ceiling
  - ACT Acoustic Ceiling Tile
  - ACT-C Cleanroom
  - ARGB Abuse-Resistant Gypsum Board
  - GB Gypsum Board
  - IRGB Impact-Resistant Gypsum Board
  - KLCT Kitchen Lay-in Ceiling Tile
  - MMRGB Moisture and Mould-Resistant Gypsum Board
  - SACT Security Acoustic Ceiling Tile
- WALL FINISHES LEGEND:**
- EWC Epoxy Wall Coating
  - HPC High Performance Coating
  - PT Paint
- CEILING FINISHES LEGEND:**
- ECC Epoxy Ceiling Coating
  - HPC High Performance Coating
  - PF Prefinished
  - PT Paint
- WALL PROTECTION LEGEND:**
- ESRP Extruded Semi-Rigid PVCu Panel
  - FRL Fibre Reinforced Laminate
  - FRP Fibreglass Reinforced Plastic
  - PVV Protective Vinyl Wallcovering
  - RHIS Rigid High Impact Sheet
  - WSSP Wetwall Solid Surface Panel
  - WVV Wetroom Vinyl Wallcovering
- FLOOR FINISHES LEGEND:**
- CFS Concrete Floor Sealer
  - EFC Epoxy Floor Coating
  - PFC Polyurethane Floor Coating
  - RAF Rubber Athletic Flooring
  - RSF Rubber Sheet Flooring
  - SCF Seamless Cushioned Flooring
  - SDRF Static-Dissipative Rubber Sheet Flooring
  - SDVF Static-Dissipative Vinyl Sheet Flooring
  - VSF Vinyl Sheet Flooring
  - WSVF Wetroom Safety Vinyl Sheet Flooring
- FLOOR BASE LEGEND:**
- FCB Flash Cove Base
  - RB Rubber Base
  - SCF Seamless Cushioned Flooring

**DOORS**

Types:

Type	Qty	Size (mm)	Material	Finish	Side Lt.	Blinds	Protect.	Privacy Film	Function	Card Reader	Mag Lock	Auto Opener	Hold Open	Hinges	Accessory 1	Accessory 2	Accessory 3	Closer
B	1	1065 x 2135	Solid Core	FRL	<input type="checkbox"/>	<input type="checkbox"/>	2 High	<input type="checkbox"/>	Passage	<input type="checkbox"/>	<input checked="" type="checkbox"/>	<input checked="" type="checkbox"/>	<input type="checkbox"/>	Butt Hinge	Elec. Strike			Concealed

**Door Remarks:**  
Refer to Appendix 10 for door interlocking requirements. Provide wave openers on door, door and hardware to be high wash compatible.

- Security Grille
- Anti-barricade strategy

**MILLWORK AND SPECIALTY CASEWORK**

**UPPER UNITS:** U1, U2, U3, U4, U5, U6, U7, U8

**LOWER UNITS:** L1, L2, L3, L4, L5, L6, L7, L8, L9, L10, L11, L12

**RECEPTION/TRANSACTION COUNTER / CARE TEAM STATION DESK:** TC1, TC2

**UTILITY SINK AND COUNTER UNIT:** UC1

**Storage Requirements:**  SHELF S1

**FINISHES**

- Full-height Cabinet:
- Upper Millwork:
- Countertop:
- Lower Millwork:
- Shelf:

**Remarks:**  
Provide ceiling hatches with gaskets.

**Legend:**

Category	Min. Length (mm)	Motorized Adjustable Height	Standing Height	Specialty Casework
Category 0 - None		<input type="checkbox"/>	<input type="checkbox"/>	<input type="checkbox"/>
Category 1 - Low (1% - 4%)		<input type="checkbox"/>	<input type="checkbox"/>	<input type="checkbox"/>
Category 2 - Med (5% - 9%)		<input type="checkbox"/>	<input type="checkbox"/>	<input type="checkbox"/>
Category 3 - High (10% or Greater)		<input type="checkbox"/>	<input type="checkbox"/>	<input type="checkbox"/>

**MECHANICAL REQUIREMENTS**

<b>PLUMBING</b> (Quantity) Hand Hygiene Sink: <input type="text"/> Lavatory: <input type="text"/> Kitchen Sink: <input type="text"/> Seamless Kitchen Sink: <input type="text"/> Utility / Process Sink: <input type="text"/> Scrub Sink: <input type="text" value="1"/> Floor Sink: <input type="text"/> Plumbing Remarks: <input type="text"/>	Other Fixtures: <input type="checkbox"/> Shower <input type="checkbox"/> Eyewash Station <input type="checkbox"/> Tub <input type="checkbox"/> Eyewash/Shower Station <input type="checkbox"/> Ice Maker <input type="checkbox"/> Emergency Shower <input type="checkbox"/> Water Closet <input type="checkbox"/> Flush Rim Sink <input type="checkbox"/> Instantaneous Hot Water <input type="checkbox"/> Floor Drain <input type="checkbox"/> <input type="checkbox"/> Water Bottle Refill Station Other <input type="text"/>	<b>MED / NON-MED GASES</b> (Quantity) Oxygen: <input type="text"/> Medical Air: <input type="text"/> Medical Vacuum: <input type="text"/> Nitrous Oxide: <input type="text"/> CO2: <input type="text"/> AGSS: <input type="text"/> Nitrogen: <input type="text"/> Laboratory Air: <input type="text"/> Laboratory Vacuum: <input type="text"/> Utility Compressed Air: <input type="text"/> Gas Remarks: <input type="text"/>
---	--	---

**Appendix 1B Minimum Room Requirements**

Room Name:

Program Number(s):

1. R1.02.03	7.	13.	19.	25.	31.	37.	43.
2.	8.	14.	20.	26.	32.	38.	44.
3.	9.	15.	21.	27.	33.	39.	45.
4.	10.	16.	22.	28.	34.	40.	46.
5.	11.	17.	23.	29.	35.	41.	47.
6.	12.	18.	24.	30.	36.	42.	48.

**ARCHITECTURAL REQUIREMENTS**

<b>WALL AND CEILING</b> Wall Material: <input type="text" value="ARGB 1.2m AFF, GB above"/> Finish: <input type="text" value="EWC"/> Ceiling Material: <input type="text" value="ACT"/> Finish: <input type="text" value="PF"/>	<b>WALL PROTECTION</b> Type: <input type="text" value="ESRP"/> <input type="checkbox"/> Corner Guards <input type="checkbox"/> Hand Rails <input type="checkbox"/> Bed Bumper / Locator Height: <input type="text" value="2185 mm"/> <input type="checkbox"/> Crash Rails <input type="checkbox"/> Chair Rail	<b>GLAZING</b> <input type="checkbox"/> Interior Glazing	<b>FLOORING TYPES</b> Material: <input type="text" value="VSF"/> Base: <input type="text" value="FCB"/>	<b>ROOM ACCESSORIES</b> <input type="checkbox"/> Coat Hooks <input type="checkbox"/> Ceiling Lift <input type="checkbox"/> Magnetic Whiteboard <input type="checkbox"/> Mirror <input type="checkbox"/> Infant Change Table <input type="checkbox"/> Privacy Curtain
---	---	---	--	--

- LEGEND:**
- WALL AND CEILING LEGEND:**
- AC Architectural Ceiling
  - ACT Acoustic Ceiling Tile
  - ACT-C Cleanroom
  - ARGB Abuse-Resistant Gypsum Board
  - GB Gypsum Board
  - IRGB Impact-Resistant Gypsum Board
  - KLCT Kitchen Lay-in Ceiling Tile
  - MMRGB Moisture and Mould-Resistant Gypsum Board
  - SACT Security Acoustic Ceiling Tile
- WALL FINISHES LEGEND:**
- EWC Epoxy Wall Coating
  - HPC High Performance Coating
  - PT Paint
- CEILING FINISHES LEGEND:**
- ECC Epoxy Ceiling Coating
  - HPC High Performance Coating
  - PF Prefinished
  - PT Paint
- WALL PROTECTION LEGEND:**
- ESRP Extruded Semi-Rigid PVCu Panel
  - FRL Fibre Reinforced Laminate
  - FRP Fibreglass Reinforced Plastic
  - PVV Protective Vinyl Wallcovering
  - RHIS Rigid High Impact Sheet
  - WSSP Wetwall Solid Surface Panel
  - WVV Wetroom Vinyl Wallcovering
- FLOOR FINISHES LEGEND:**
- CFS Concrete Floor Sealer
  - EFC Epoxy Floor Coating
  - PFC Polyurethane Floor Coating
  - RAF Rubber Athletic Flooring
  - RSF Rubber Sheet Flooring
  - SCF Seamless Cushioned Flooring
  - SDRF Static-Dissipative Rubber Sheet Flooring
  - SDVF Static-Dissipative Vinyl Sheet Flooring
  - VSF Vinyl Sheet Flooring
  - WSVF Wetroom Safety Vinyl Sheet Flooring
- FLOOR BASE LEGEND:**
- FCB Flash Cove Base
  - RB Rubber Base
  - SCF Seamless Cushioned Flooring

**DOORS**

Types:

Type:Qty:	Size (mm):	Material:	Finish:	Side Lt:	Blinds:	Protect.:	Privacy Film:	Function:	Card Reader:	Mag Lock:	Auto Opener:	Hold Open:	Hinges:	Accessory 1:	Accessory 2:	Accessory 3:	Closer:

Door Remarks:  Security Grille  Anti-barricade strategy

**MILLWORK AND SPECIALTY CASEWORK**

Storage Requirements:

**UPPER UNITS** (U1-U8) **SHELF** (S1)

**FULL-HEIGHT CABINETS** (C1-C5) **LOWER UNITS** (L1-L12) **RECEPTION/TRANSACTION COUNTER / CARE TEAM STATION DESK** (TC1-TC2) **UTILITY SINK AND COUNTER UNIT** (UC1)

Category	Min. Length (mm)	Motorized Adjustable Height	Standing Height	Specialty Casework
Category 0 - None				
Category 1 - Low (1% - 4%)				
Category 2 - Med (5% - 9%)				
Category 3 - High (10% or Greater)				

**FINISHES**

Full-height Cabinet:   
 Upper Millwork:   
 Countertop:   
 Lower Millwork:   
 Shelf:

Remarks:

**MECHANICAL REQUIREMENTS**

<b>PLUMBING</b> (Quantity) Hand Hygiene Sink: <input type="text"/> Lavatory: <input type="text"/> Kitchen Sink: <input type="text"/> Seamless Kitchen Sink: <input type="text"/> Utility / Process Sink: <input type="text"/> Scrub Sink: <input type="text"/> Floor Sink: <input type="text"/> Plumbing Remarks: <input type="text"/>	Other Fixtures: <input type="checkbox"/> Shower <input type="checkbox"/> Eyewash Station <input type="checkbox"/> Tub <input type="checkbox"/> Eyewash/Shower Station <input type="checkbox"/> Ice Maker <input type="checkbox"/> Emergency Shower <input type="checkbox"/> Water Closet <input type="checkbox"/> Flush Rim Sink <input type="checkbox"/> Instantaneous Hot Water <input type="checkbox"/> Floor Drain <input type="checkbox"/> Water Bottle Refill Station Other <input type="text"/>	<b>MED / NON-MED GASES</b> (Quantity) Oxygen: <input type="text"/> Medical Air: <input type="text"/> Medical Vacuum: <input type="text"/> Nitrous Oxide: <input type="text"/> CO2: <input type="text"/> AGSS: <input type="text"/> Nitrogen: <input type="text"/> Laboratory Air: <input type="text"/> Laboratory Vacuum: <input type="text"/> Utility Compressed Air: <input type="text"/> Gas Remarks: <input type="text"/>
---	---	--



**Appendix 1B Minimum Room Requirements**

Room Name:

Program Number(s):

1. R3.07	7.	13.	19.	25.	31.	37.	43.
2.	8.	14.	20.	26.	32.	38.	44.
3.	9.	15.	21.	27.	33.	39.	45.
4.	10.	16.	22.	28.	34.	40.	46.
5.	11.	17.	23.	29.	35.	41.	47.
6.	12.	18.	24.	30.	36.	42.	48.

**ARCHITECTURAL REQUIREMENTS**

<b>WALL AND CEILING</b> Wall Material: <input type="text" value="ARGB 1.2m AFF, GB above"/> Finish: <input type="text" value="EWC"/> Ceiling Material: <input type="text" value="GB"/> Finish: <input type="text" value="ECC"/>	<b>WALL PROTECTION</b> Type: <input type="text" value="ESRP"/> <input checked="" type="checkbox"/> Corner Guards <input type="checkbox"/> Hand Rails <input type="checkbox"/> Bed Bumper / Locator Height: <input type="text" value="2185 mm"/> <input type="checkbox"/> Crash Rails <input type="checkbox"/> Chair Rail	<b>GLAZING</b> <input checked="" type="checkbox"/> Interior Glazing	<b>FLOORING TYPES</b> Material: <input type="text" value="VSF"/> Base: <input type="text" value="FCB"/>	<b>ROOM ACCESSORIES</b> <input type="checkbox"/> Coat Hooks <input type="checkbox"/> Ceiling Lift <input type="checkbox"/> Magnetic Whiteboard <input type="checkbox"/> Mirror <input type="checkbox"/> Infant Change Table <input type="checkbox"/> Privacy Curtain
---	--	--	--	--

- LEGEND:**
- WALL AND CEILING LEGEND:**
- AC Architectural Ceiling
  - ACT Acoustic Ceiling Tile
  - ACT-C Cleanroom
  - ARGB Abuse-Resistant Gypsum Board
  - GB Gypsum Board
  - IRGB Impact-Resistant Gypsum Board
  - KLCT Kitchen Lay-in Ceiling Tile
  - MMRGB Moisture and Mould-Resistant Gypsum Board
  - SACT Security Acoustic Ceiling Tile
- WALL FINISHES LEGEND:**
- EWC Epoxy Wall Coating
  - HPC High Performance Coating
  - PT Paint
- CEILING FINISHES LEGEND:**
- ECC Epoxy Ceiling Coating
  - HPC High Performance Coating
  - PF Prefinished
  - PT Paint
- WALL PROTECTION LEGEND:**
- ESRP Extruded Semi-Rigid PVCu Panel
  - FRL Fibre Reinforced Laminate
  - FRP Fibreglass Reinforced Plastic
  - PVV Protective Vinyl Wallcovering
  - RHIS Rigid High Impact Sheet
  - WSSP Wetwall Solid Surface Panel
  - WVV Wetroom Vinyl Wallcovering
- FLOOR FINISHES LEGEND:**
- CFS Concrete Floor Sealer
  - EFC Epoxy Floor Coating
  - PFC Polyurethane Floor Coating
  - RAF Rubber Athletic Flooring
  - RSF Rubber Sheet Flooring
  - SCF Seamless Cushioned Flooring
  - SDRF Static-Dissipative Rubber Sheet Flooring
  - SDVF Static-Dissipative Vinyl Sheet Flooring
  - VSF Vinyl Sheet Flooring
  - WSVF Wetroom Safety Vinyl Sheet Flooring
- FLOOR BASE LEGEND:**
- FCB Flash Cove Base
  - RB Rubber Base
  - SCF Seamless Cushioned Flooring

**DOORS**

Types:

Type	Qty	Size (mm)	Material	Finish	Side Lt.	Blinds	Protect.	Privacy Film	Function	Card Reader	Mag Lock	Auto Opener	Hold Open	Hinges	Accessory 1	Accessory 2	Accessory 3	Closer
B	1	1065 x 2135	Solid Core	FRL	<input type="checkbox"/>	<input type="checkbox"/>	2 High	<input type="checkbox"/>	Passage	<input type="checkbox"/>	<input type="checkbox"/>	<input checked="" type="checkbox"/>	<input type="checkbox"/>	Butt Hinge	Elec. Strike			Concealed

**Door Remarks:**  
Refer to Appendix 10 for door interlocking requirements. Provide wave openers on door, door and hardware to be high wash compatible.

Security Grille  
 Anti-barricade strategy

**MILLWORK AND SPECIALTY CASEWORK**

**UPPER UNITS:** U1, U2, U3, U4, U5, U6, U7, U8

**LOWER UNITS:** L1, L2, L3, L4, L5, L6, L7, L8, L9, L10, L11, L12

**RECEPTION/TRANSACTION COUNTER / CARE TEAM STATION DESK:** TC1, TC2

**UTILITY SINK AND COUNTER UNIT:** UC1

**Storage Requirements:**  SHELF S1

**FINISHES**

Full-height Cabinet:   
 Upper Millwork:   
 Countertop:   
 Lower Millwork:   
 Shelf:

**Remarks:**  
Provide ceiling hatches with gaskets.

**Legend:**  
 Category 0 - None  
 Category 1 - Low (1% - 4%)  
 Category 2 - Med (5% - 9%)  
 Category 3 - High (10% or Greater)

Category	Min. Length (mm)	Motorized Adjustable Height	Standing Height	Specialty Casework
<input type="checkbox"/>	<input type="checkbox"/>	<input type="checkbox"/>	<input type="checkbox"/>	<input type="checkbox"/>

**MECHANICAL REQUIREMENTS**

<b>PLUMBING</b> (Quantity) Hand Hygiene Sink: <input type="text"/> Lavatory: <input type="text"/> Kitchen Sink: <input type="text"/> Seamless Kitchen Sink: <input type="text"/> Utility / Process Sink: <input type="text"/> Scrub Sink: <input type="text"/> Floor Sink: <input type="text"/> Plumbing Remarks: <input type="text"/>	Other Fixtures: <input type="checkbox"/> Shower <input type="checkbox"/> Tub <input type="checkbox"/> Ice Maker <input type="checkbox"/> Water Closet <input type="checkbox"/> Instantaneous Hot Water <input type="checkbox"/> Eyewash Station <input type="checkbox"/> Eyewash/Shower Station <input type="checkbox"/> Emergency Shower <input type="checkbox"/> Flush Rim Sink <input type="checkbox"/> Floor Drain <input type="checkbox"/> Water Bottle Refill Station Other: <input type="text"/>	<b>MED / NON-MED GASES</b> (Quantity) Oxygen: <input type="text"/> Medical Air: <input type="text"/> Medical Vacuum: <input type="text"/> Nitrous Oxide: <input type="text"/> CO2: <input type="text"/> AGSS: <input type="text"/> Nitrogen: <input type="text"/> Laboratory Air: <input type="text"/> Laboratory Vacuum: <input type="text"/> Utility Compressed Air: <input type="text"/> Gas Remarks: <input type="text"/>
---	---	---

# Appendix 1B Minimum Room Requirements

Room Name:

Program Number(s):

1. R3.04	7.	13.	19.	25.	31.	37.	43.
2.	8.	14.	20.	26.	32.	38.	44.
3.	9.	15.	21.	27.	33.	39.	45.
4.	10.	16.	22.	28.	34.	40.	46.
5.	11.	17.	23.	29.	35.	41.	47.
6.	12.	18.	24.	30.	36.	42.	48.

## ARCHITECTURAL REQUIREMENTS

<b>WALL AND CEILING</b> Wall Material: <input type="text" value="ARGB 1.2m AFF, GB above"/> Finish: <input type="text" value="EWC"/> Ceiling Material: <input type="text" value="GB"/> Finish: <input type="text" value="ECC"/>	<b>WALL PROTECTION</b> Type: <input type="text" value="ESRP"/> <input checked="" type="checkbox"/> Corner Guards <input type="checkbox"/> Hand Rails <input type="checkbox"/> Bed Bumper / Locator Height: <input type="text" value="2185 mm"/> <input type="checkbox"/> Crash Rails <input type="checkbox"/> Chair Rail	<b>GLAZING</b> <input checked="" type="checkbox"/> Interior Glazing	<b>FLOORING TYPES</b> Material: <input type="text" value="VSF"/> Base: <input type="text" value="FCB"/>	<b>ROOM ACCESSORIES</b> <input type="checkbox"/> Coat Hooks <input type="checkbox"/> Ceiling Lift <input type="checkbox"/> Magnetic Whiteboard <input type="checkbox"/> Mirror <input type="checkbox"/> Infant Change Table <input type="checkbox"/> Privacy Curtain
---	--	--	--	--

- LEGEND:**
- WALL AND CEILING LEGEND:**
- AC Architectural Ceiling
  - ACT Acoustic Ceiling Tile
  - ACT-C Cleanroom
  - ARGB Abuse-Resistant Gypsum Board
  - GB Gypsum Board
  - IRGB Impact-Resistant Gypsum Board
  - KLCT Kitchen Lay-in Ceiling Tile
  - MMRGB Moisture and Mould-Resistant Gypsum Board
  - SACT Security Acoustic Ceiling Tile
- WALL FINISHES LEGEND:**
- EWC Epoxy Wall Coating
  - HPC High Performance Coating
  - PT Paint
- CEILING FINISHES LEGEND:**
- ECC Epoxy Ceiling Coating
  - HPC High Performance Coating
  - PF Prefinished
  - PT Paint
- WALL PROTECTION LEGEND:**
- ESRP Extruded Semi-Rigid PVCu Panel
  - FRL Fibre Reinforced Laminate
  - FRP Fibreglass Reinforced Plastic
  - PVV Protective Vinyl Wallcovering
  - RHIS Rigid High Impact Sheet
  - WSSP Wetwall Solid Surface Panel
  - WVV Wetroom Vinyl Wallcovering
- FLOOR FINISHES LEGEND:**
- CFS Concrete Floor Sealer
  - EFC Epoxy Floor Coating
  - PFC Polyurethane Floor Coating
  - RAF Rubber Athletic Flooring
  - RSF Rubber Sheet Flooring
  - SCF Seamless Cushioned Flooring
  - SDRF Static-Dissipative Rubber Sheet Flooring
  - SDVF Static-Dissipative Vinyl Sheet Flooring
  - VSF Vinyl Sheet Flooring
  - WSVF Wetroom Safety Vinyl Sheet Flooring
- FLOOR BASE LEGEND:**
- FCB Flash Cove Base
  - RB Rubber Base
  - SCF Seamless Cushioned Flooring

**DOORS**

Types:

Type	Qty	Size (mm)	Material	Finish	Side Lt.	Blinds	Protect.	Privacy Film	Function	Card Reader	Mag Lock	Auto Opener	Hold Open	Hinges	Accessory 1	Accessory 2	Accessory 3	Closer
B	1	1065 x 2135	Solid Core	FRL	<input type="checkbox"/>	<input checked="" type="checkbox"/>	2 High	<input type="checkbox"/>	Passage	<input type="checkbox"/>	<input type="checkbox"/>	<input checked="" type="checkbox"/>	<input type="checkbox"/>	Butt Hinge	Elec. Strike			Concealed

**Door Remarks:**  
 Refer to Appendix 10 for door interlocking requirements. Provide wave openers on door, door and hardware to be high wash compatible.

Security Grille  
 Anti-barricade strategy

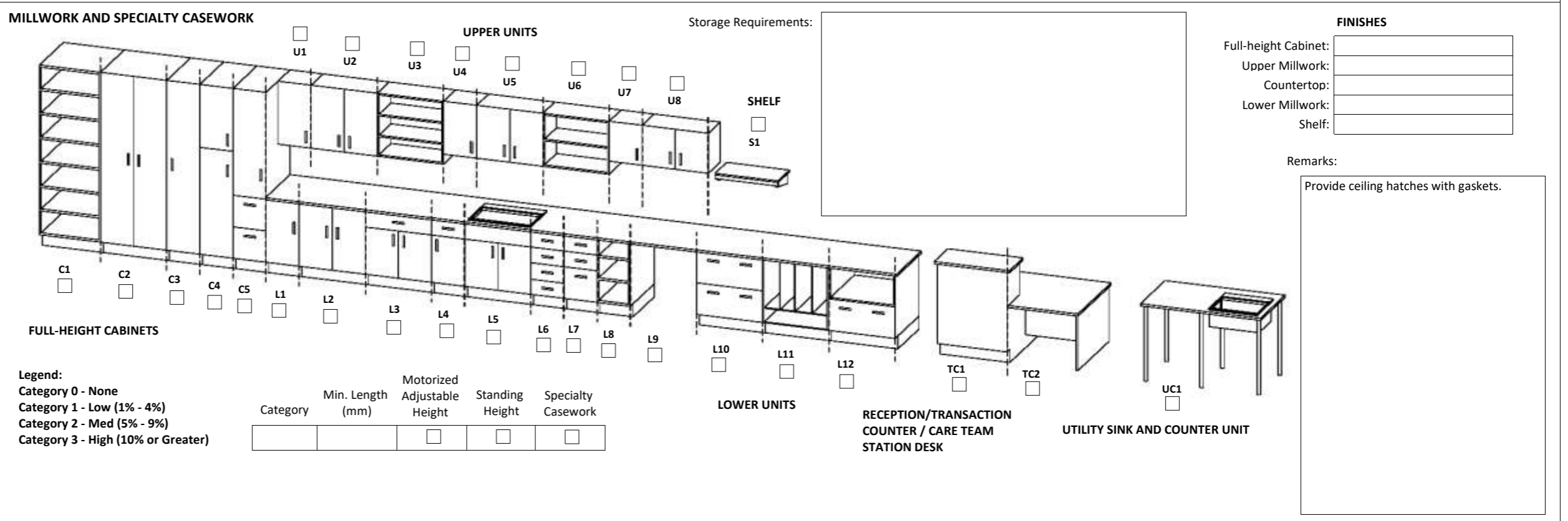

## MECHANICAL REQUIREMENTS

<p><b>PLUMBING</b> (Quantity)</p> <table border="1" style="width:100%"> <tr> <td>Hand Hygiene Sink:</td> <td>Lavatory:</td> <td>Kitchen Sink:</td> <td>Seamless Kitchen Sink:</td> <td>Utility / Process Sink:</td> <td>Scrub Sink:</td> <td>Floor Sink:</td> </tr> <tr> <td><input type="text"/></td> <td><input type="text"/></td> <td><input type="text"/></td> <td><input type="text"/></td> <td><input type="text"/></td> <td><input type="text"/></td> <td><input type="text"/></td> </tr> </table> <p>Plumbing Remarks: <input style="width:100%" type="text"/></p>	Hand Hygiene Sink:	Lavatory:	Kitchen Sink:	Seamless Kitchen Sink:	Utility / Process Sink:	Scrub Sink:	Floor Sink:	<input type="text"/>	<input type="text"/>	<input type="text"/>	<input type="text"/>	<input type="text"/>	<input type="text"/>	<input type="text"/>	<p><b>Other Fixtures:</b></p> <table border="1" style="width:100%"> <tr> <td><input type="checkbox"/> Shower</td> <td><input type="checkbox"/> Eyewash Station</td> </tr> <tr> <td><input type="checkbox"/> Tub</td> <td><input type="checkbox"/> Eyewash/Shower Station</td> </tr> <tr> <td><input type="checkbox"/> Ice Maker</td> <td><input type="checkbox"/> Emergency Shower</td> </tr> <tr> <td><input type="checkbox"/> Water Closet</td> <td><input type="checkbox"/> Flush Rim Sink</td> </tr> <tr> <td><input type="checkbox"/> Instantaneous Hot Water</td> <td><input type="checkbox"/> Floor Drain</td> </tr> <tr> <td></td> <td><input type="checkbox"/> Water Bottle Refill Station</td> </tr> <tr> <td></td> <td>Other: <input type="text"/></td> </tr> </table>	<input type="checkbox"/> Shower	<input type="checkbox"/> Eyewash Station	<input type="checkbox"/> Tub	<input type="checkbox"/> Eyewash/Shower Station	<input type="checkbox"/> Ice Maker	<input type="checkbox"/> Emergency Shower	<input type="checkbox"/> Water Closet	<input type="checkbox"/> Flush Rim Sink	<input type="checkbox"/> Instantaneous Hot Water	<input type="checkbox"/> Floor Drain		<input type="checkbox"/> Water Bottle Refill Station		Other: <input type="text"/>	<p><b>MED / NON-MED GASES</b> (Quantity)</p> <table border="1" style="width:100%"> <tr> <td>Oxygen:</td> <td>Medical Air:</td> <td>Medical Vacuum:</td> <td>Nitrous Oxide:</td> <td>CO2:</td> <td>AGSS:</td> <td>Nitrogen:</td> <td>Laboratory Air:</td> <td>Laboratory Vacuum:</td> <td>Utility Compressed Air:</td> </tr> <tr> <td><input type="text"/></td> <td><input type="text"/></td> <td><input type="text"/></td> <td><input type="text"/></td> <td><input type="text"/></td> <td><input type="text"/></td> <td><input type="text"/></td> <td><input type="text"/></td> <td><input type="text"/></td> <td><input type="text"/></td> </tr> </table> <p>Gas Remarks: <input style="width:100%" type="text"/></p>	Oxygen:	Medical Air:	Medical Vacuum:	Nitrous Oxide:	CO2:	AGSS:	Nitrogen:	Laboratory Air:	Laboratory Vacuum:	Utility Compressed Air:	<input type="text"/>	<input type="text"/>	<input type="text"/>	<input type="text"/>	<input type="text"/>	<input type="text"/>	<input type="text"/>	<input type="text"/>	<input type="text"/>	<input type="text"/>
Hand Hygiene Sink:	Lavatory:	Kitchen Sink:	Seamless Kitchen Sink:	Utility / Process Sink:	Scrub Sink:	Floor Sink:																																												
<input type="text"/>	<input type="text"/>	<input type="text"/>	<input type="text"/>	<input type="text"/>	<input type="text"/>	<input type="text"/>																																												
<input type="checkbox"/> Shower	<input type="checkbox"/> Eyewash Station																																																	
<input type="checkbox"/> Tub	<input type="checkbox"/> Eyewash/Shower Station																																																	
<input type="checkbox"/> Ice Maker	<input type="checkbox"/> Emergency Shower																																																	
<input type="checkbox"/> Water Closet	<input type="checkbox"/> Flush Rim Sink																																																	
<input type="checkbox"/> Instantaneous Hot Water	<input type="checkbox"/> Floor Drain																																																	
	<input type="checkbox"/> Water Bottle Refill Station																																																	
	Other: <input type="text"/>																																																	
Oxygen:	Medical Air:	Medical Vacuum:	Nitrous Oxide:	CO2:	AGSS:	Nitrogen:	Laboratory Air:	Laboratory Vacuum:	Utility Compressed Air:																																									
<input type="text"/>	<input type="text"/>	<input type="text"/>	<input type="text"/>	<input type="text"/>	<input type="text"/>	<input type="text"/>	<input type="text"/>	<input type="text"/>	<input type="text"/>																																									

**Appendix 1B Minimum Room Requirements**

Room Name:

Program Number(s):

1. R2.05	7.	13.	19.	25.	31.	37.	43.
2.	8.	14.	20.	26.	32.	38.	44.
3.	9.	15.	21.	27.	33.	39.	45.
4.	10.	16.	22.	28.	34.	40.	46.
5.	11.	17.	23.	29.	35.	41.	47.
6.	12.	18.	24.	30.	36.	42.	48.

**ARCHITECTURAL REQUIREMENTS**

<b>WALL AND CEILING</b> Wall Material: <input type="text" value="ARGB 1.2m AFF, GB above"/> Finish: <input type="text" value="EWC"/> Ceiling Material: <input type="text" value="ACT"/> Finish: <input type="text" value="PF"/>	<b>WALL PROTECTION</b> Type: <input type="text" value="ESRP"/> <input type="checkbox"/> Corner Guards <input type="checkbox"/> Hand Rails <input type="checkbox"/> Bed Bumper / Locator Height: <input type="text" value="2185 mm"/> <input type="checkbox"/> Crash Rails <input type="checkbox"/> Chair Rail	<b>GLAZING</b> <input type="checkbox"/> Interior Glazing	<b>FLOORING TYPES</b> Material: <input type="text" value="WSVF"/> Base: <input type="text" value="FCB"/>	<b>ROOM ACCESSORIES</b> <input type="checkbox"/> Coat Hooks <input type="checkbox"/> Ceiling Lift <input type="checkbox"/> Magnetic Whiteboard <input type="checkbox"/> Mirror <input type="checkbox"/> Infant Change Table <input type="checkbox"/> Privacy Curtain
---	---	---	---	--

- LEGEND:**
- WALL AND CEILING LEGEND:**
- AC Architectural Ceiling
  - ACT Acoustic Ceiling Tile
  - ACT-C Cleanroom
  - ARGB Abuse-Resistant Gypsum Board
  - GB Gypsum Board
  - IRGB Impact-Resistant Gypsum Board
  - KLCT Kitchen Lay-in Ceiling Tile
  - MMRGB Moisture and Mould-Resistant Gypsum Board
  - SACT Security Acoustic Ceiling Tile
- WALL FINISHES LEGEND:**
- EWC Epoxy Wall Coating
  - HPC High Performance Coating
  - PT Paint
- CEILING FINISHES LEGEND:**
- ECC Epoxy Ceiling Coating
  - HPC High Performance Coating
  - PF Prefinished
  - PT Paint
- WALL PROTECTION LEGEND:**
- ESRP Extruded Semi-Rigid PVCu Panel
  - FRL Fibre Reinforced Laminate
  - FRP Fibreglass Reinforced Plastic
  - PVV Protective Vinyl Wallcovering
  - RHIS Rigid High Impact Sheet
  - WSSP Wetwall Solid Surface Panel
  - WVV Wetroom Vinyl Wallcovering
- FLOOR FINISHES LEGEND:**
- CFS Concrete Floor Sealer
  - EFC Epoxy Floor Coating
  - PFC Polyurethane Floor Coating
  - RAF Rubber Athletic Flooring
  - RSF Rubber Sheet Flooring
  - SCF Seamless Cushioned Flooring
  - SDRF Static-Dissipative Rubber Sheet Flooring
  - SDVF Static-Dissipative Vinyl Sheet Flooring
  - VSF Vinyl Sheet Flooring
  - WSVF Wetroom Safety Vinyl Sheet Flooring
- FLOOR BASE LEGEND:**
- FCB Flash Cove Base
  - RB Rubber Base
  - SCF Seamless Cushioned Flooring

**DOORS**

Types:

Type:Qty:	Size (mm):	Material:	Finish:	Side Lt:	Blinds:	Protect.:	Privacy Film:	Function:	Card Reader:	Mag Lock:	Auto Opener:	Hold Open:	Hinges:	Accessory 1:	Accessory 2:	Accessory 3:	Closer:

Door Remarks:  Security Grille  Anti-barricade strategy

**MILLWORK AND SPECIALTY CASEWORK**

**UPPER UNITS** (U1-U8) **SHELF** (S1)

**LOWER UNITS** (L1-L12) **RECEPTION/TRANSACTION COUNTER / CARE TEAM STATION DESK** (TC1-TC2) **UTILITY SINK AND COUNTER UNIT** (UC1)

**FULL-HEIGHT CABINETS** (C1-C5)

Storage Requirements:

Category	Min. Length (mm)	Motorized Adjustable Height	Standing Height	Specialty Casework
2	6300	<input checked="" type="checkbox"/>	<input checked="" type="checkbox"/>	<input checked="" type="checkbox"/>

**FINISHES**

Full-height Cabinet:   
 Upper Millwork:   
 Countertop:   
 Lower Millwork:   
 Shelf:

Remarks: Refer to Schedule 1, Section 6.12 (Division 12) for Specialty Casework. Items indicated are diagrammatic, provide specialty casework appropriate for the specific and specialized functions to be performed in the space and to accommodate Equipment. Provide work counter with utility sink (2.0nsm), 5 tech order review workstations (2.8nsm), and 1 pre-packaging workstations (4.6nsm), and Dispensing Station with shelving (12.0nsm).

**MECHANICAL REQUIREMENTS**

<b>PLUMBING</b> (Quantity) Hand Hygiene Sink: <input type="text"/> Lavatory: <input type="text"/> Kitchen Sink: <input type="text"/> Seamless Kitchen Sink: <input type="text"/> Utility / Process Sink: <input type="text" value="1"/> Scrub Sink: <input type="text"/> Floor Sink: <input type="text"/> Plumbing Remarks: <input type="text"/>	Other Fixtures: <input type="checkbox"/> Shower <input type="checkbox"/> Eyewash Station <input type="checkbox"/> Tub <input type="checkbox"/> Eyewash/Shower Station <input type="checkbox"/> Ice Maker <input type="checkbox"/> Emergency Shower <input type="checkbox"/> Water Closet <input type="checkbox"/> Flush Rim Sink <input type="checkbox"/> Instantaneous Hot Water <input type="checkbox"/> Floor Drain <input type="checkbox"/> Water Bottle Refill Station Other: <input type="text"/>	<b>MED / NON-MED GASES</b> (Quantity) Oxygen: <input type="text"/> Medical Air: <input type="text"/> Medical Vacuum: <input type="text"/> Nitrous Oxide: <input type="text"/> CO2: <input type="text"/> AGSS: <input type="text"/> Nitrogen: <input type="text"/> Laboratory Air: <input type="text"/> Laboratory Vacuum: <input type="text"/> Utility Compressed Air: <input type="text"/> Gas Remarks: <input type="text"/>
---	--	--



**Appendix 1B Minimum Room Requirements**

Room Name:

Program Number(s):	1. R3.02	7.	13.	19.	25.	31.	37.	43.
	2.	8.	14.	20.	26.	32.	38.	44.
	3.	9.	15.	21.	27.	33.	39.	45.
	4.	10.	16.	22.	28.	34.	40.	46.
	5.	11.	17.	23.	29.	35.	41.	47.
	6.	12.	18.	24.	30.	36.	42.	48.

**ARCHITECTURAL REQUIREMENTS**

<b>WALL AND CEILING</b> Wall Material: <input type="text" value="ARGB 1.2m AFF, GB above"/> Finish: <input type="text" value="EWC"/> Ceiling Material: <input type="text" value="ACT"/> Finish: <input type="text" value="PF"/>		<b>WALL PROTECTION</b> Type: <input type="text" value="ESRP"/> <input checked="" type="checkbox"/> Corner Guards <input type="checkbox"/> Hand Rails <input type="checkbox"/> Bed Bumper / Locator Height: <input type="text" value="2185 mm"/> <input type="checkbox"/> Crash Rails <input type="checkbox"/> Chair Rail		<b>GLAZING</b> <input checked="" type="checkbox"/> Interior Glazing		<b>FLOORING TYPES</b> Material: <input type="text" value="VSF"/> Base: <input type="text" value="FCB"/>		<b>ROOM ACCESSORIES</b> <input type="checkbox"/> Coat Hooks <input type="checkbox"/> Ceiling Lift <input checked="" type="checkbox"/> Magnetic Whiteboard <input type="checkbox"/> Mirror <input type="checkbox"/> Infant Change Table <input type="checkbox"/> Privacy Curtain	
---	--	--	--	--	--	--	--	---	--

- LEGEND:**
- WALL AND CEILING LEGEND:**
- AC Architectural Ceiling
  - ACT Acoustic Ceiling Tile
  - ACT-C Cleanroom
  - ARGB Abuse-Resistant Gypsum Board
  - GB Gypsum Board
  - IRGB Impact-Resistant Gypsum Board
  - KLCT Kitchen Lay-in Ceiling Tile
  - MMRGB Moisture and Mould-Resistant Gypsum Board
  - SACT Security Acoustic Ceiling Tile
- WALL FINISHES LEGEND:**
- EWC Epoxy Wall Coating
  - HPC High Performance Coating
  - PT Paint
- CEILING FINISHES LEGEND:**
- ECC Epoxy Ceiling Coating
  - HPC High Performance Coating
  - PF Prefinished
  - PT Paint
- WALL PROTECTION LEGEND:**
- ESRP Extruded Semi-Rigid PVCu Panel
  - FRL Fibre Reinforced Laminate
  - FRP Fibreglass Reinforced Plastic
  - PVV Protective Vinyl Wallcovering
  - RHIS Rigid High Impact Sheet
  - WSSP Wetwall Solid Surface Panel
  - WVV Wetroom Vinyl Wallcovering
- FLOOR FINISHES LEGEND:**
- CFS Concrete Floor Sealer
  - EFC Epoxy Floor Coating
  - PFC Polyurethane Floor Coating
  - RAF Rubber Athletic Flooring
  - RSF Rubber Sheet Flooring
  - SCF Seamless Cushioned Flooring
  - SDRF Static-Dissipative Rubber Sheet Flooring
  - SDVF Static-Dissipative Vinyl Sheet Flooring
  - VSF Vinyl Sheet Flooring
  - WSVF Wetroom Safety Vinyl Sheet Flooring
- FLOOR BASE LEGEND:**
- FCB Flash Cove Base
  - RB Rubber Base
  - SCF Seamless Cushioned Flooring

**DOORS**

Types:

Type:Qty:	Size (mm):	Material:	Finish:	Side Lt:	Blinds:	Protect.:	Privacy Film:	Function:	Card Reader:	Mag Lock:	Auto Opener:	Hold Open:	Hinges:	Accessory 1:	Accessory 2:	Accessory 3:	Closer:

Door Remarks:

Security Grille  
 Anti-barricade strategy

**MILLWORK AND SPECIALTY CASEWORK**

Storage Requirements:

**UPPER UNITS** U1, U2, U3, U4, U5, U6, U7, U8

**LOWER UNITS** L1, L2, L3, L4, L5, L6, L7, L8, L9, L10, L11, L12

**RECEPTION/TRANSACTION COUNTER / CARE TEAM STATION DESK** TC1, TC2

**UTILITY SINK AND COUNTER UNIT** UC1

**FULL-HEIGHT CABINETS** C1, C2, C3, C4, C5

**SHELF** S1

Category	Min. Length (mm)	Motorized Adjustable Height	Standing Height	Specialty Casework
3	6900			<input checked="" type="checkbox"/>

**FINISHES**

Full-height Cabinet:   
 Upper Millwork:   
 Countertop:   
 Lower Millwork:   
 Shelf:

Remarks: Refer to Schedule 1, Section 6.12 (Division 12) for Specialty Casework. Items indicated are diagrammatic, provide specialty casework appropriate for the specific and specialized functions to be performed in the space and to accommodate Equipment. Provide setup counter for cart circulation, incl. 2 PC's, 2 printers, and an IV Workflow Management System (facilitate remote production and verification of CIVA products).

**MECHANICAL REQUIREMENTS**

<b>PLUMBING</b> (Quantity) Hygiene Sink: <input type="text" value="2"/> Lavatory: <input type="text"/> Kitchen Sink: <input type="text"/> Kitchen Sink: <input type="text"/> Utility / Process Sink: <input type="text" value="1"/> Scrub Sink: <input type="text"/> Floor Sink: <input type="text"/>		Other Fixtures: <input type="checkbox"/> Shower <input type="checkbox"/> Eyewash Station <input type="checkbox"/> Tub <input type="checkbox"/> Eyewash/Shower Station <input type="checkbox"/> Ice Maker <input type="checkbox"/> Emergency Shower <input type="checkbox"/> Water Closet <input type="checkbox"/> Flush Rim Sink <input type="checkbox"/> Instantaneous Hot Water <input type="checkbox"/> Floor Drain <input type="checkbox"/> <input type="checkbox"/> Water Bottle Refill Station Other: <input type="text"/>		<b>MED / NON-MED GASES</b> (Quantity) Oxygen: <input type="text"/> Medical Air: <input type="text"/> Medical Vacuum: <input type="text"/> Nitrous Oxide: <input type="text"/> CO2: <input type="text"/> AGSS: <input type="text"/> Nitrogen: <input type="text"/> Laboratory Air: <input type="text"/> Laboratory Vacuum: <input type="text"/> Utility Compressed Air: <input type="text"/>	
Plumbing Remarks: <input type="text" value="Provide (2) HHS distributed immediately outside each Anteroom."/>				Gas Remarks: <input type="text"/>	

**Appendix 1B Minimum Room Requirements**

Room Name:

Program Number(s):

1. R2.06	7.	13.	19.	25.	31.	37.	43.
2.	8.	14.	20.	26.	32.	38.	44.
3.	9.	15.	21.	27.	33.	39.	45.
4.	10.	16.	22.	28.	34.	40.	46.
5.	11.	17.	23.	29.	35.	41.	47.
6.	12.	18.	24.	30.	36.	42.	48.

**ARCHITECTURAL REQUIREMENTS**

<b>WALL AND CEILING</b> Wall Material: <input type="text" value="ARGB 1.2m AFF, GB above"/> Finish: <input type="text" value="EWC"/> Ceiling Material: <input type="text" value="ACT"/> Finish: <input type="text" value="PF"/>		<b>WALL PROTECTION</b> Type: <input type="text" value="ESRP"/> <input checked="" type="checkbox"/> Corner Guards <input type="checkbox"/> Hand Rails <input type="checkbox"/> Bed Bumper / Locator Height: <input type="text" value="2185 mm"/> <input type="checkbox"/> Crash Rails <input type="checkbox"/> Chair Rail		<b>GLAZING</b> <input type="checkbox"/> Interior Glazing		<b>FLOORING TYPES</b> Material: <input type="text" value="VSF"/> Base: <input type="text" value="FCB"/>		<b>ROOM ACCESSORIES</b> <input type="checkbox"/> Coat Hooks <input type="checkbox"/> Ceiling Lift <input checked="" type="checkbox"/> Magnetic Whiteboard <input type="checkbox"/> Mirror <input type="checkbox"/> Infant Change Table <input type="checkbox"/> Privacy Curtain	
---	--	--	--	---	--	--	--	---	--

- LEGEND:**
- WALL AND CEILING LEGEND:**
- AC Architectural Ceiling
  - ACT Acoustic Ceiling Tile
  - ACT-C Cleanroom
  - ARGB Abuse-Resistant Gypsum Board
  - GB Gypsum Board
  - IRGB Impact-Resistant Gypsum Board
  - KLCT Kitchen Lay-in Ceiling Tile
  - MMRGB Moisture and Mould-Resistant Gypsum Board
  - SACT Security Acoustic Ceiling Tile
- WALL FINISHES LEGEND:**
- EWC Epoxy Wall Coating
  - HPC High Performance Coating
  - PT Paint
- CEILING FINISHES LEGEND:**
- ECC Epoxy Ceiling Coating
  - HPC High Performance Coating
  - PF Prefinished
  - PT Paint
- WALL PROTECTION LEGEND:**
- ESRP Extruded Semi-Rigid PVCu Panel
  - FRL Fibre Reinforced Laminate
  - FRP Fibreglass Reinforced Plastic
  - PVV Protective Vinyl Wallcovering
  - RHIS Rigid High Impact Sheet
  - WSSP Wetwall Solid Surface Panel
  - WWW Wetroom Vinyl Wallcovering
- FLOOR FINISHES LEGEND:**
- CFS Concrete Floor Sealer
  - EFC Epoxy Floor Coating
  - PFC Polyurethane Floor Coating
  - RAF Rubber Athletic Flooring
  - RSF Rubber Sheet Flooring
  - SCF Seamless Cushioned Flooring
  - SDRF Static-Dissipative Rubber Sheet Flooring
  - SDVF Static-Dissipative Vinyl Sheet Flooring
  - VSF Vinyl Sheet Flooring
  - WSVF Wetroom Safety Vinyl Sheet Flooring
- FLOOR BASE LEGEND:**
- FCB Flash Cove Base
  - RB Rubber Base
  - SCF Seamless Cushioned Flooring

**DOORS**

Types:

Type	Qty	Size (mm)	Material	Finish	Side Lt.	Blinds	Protect.	Privacy Film	Function	Card Reader	Mag Lock	Auto Opener	Hold Open	Hinges	Accessory 1	Accessory 2	Accessory 3	Closer
C	1	1220 x 2135	Hollow Metal	Paint	<input type="checkbox"/>	<input type="checkbox"/>	2 High	<input type="checkbox"/>	Storeroom	<input checked="" type="checkbox"/>	<input type="checkbox"/>	<input type="checkbox"/>	<input checked="" type="checkbox"/>	Butt Hinge	Elec. Strike			Surface

Door Remarks:  Security Grille  Anti-barricade strategy

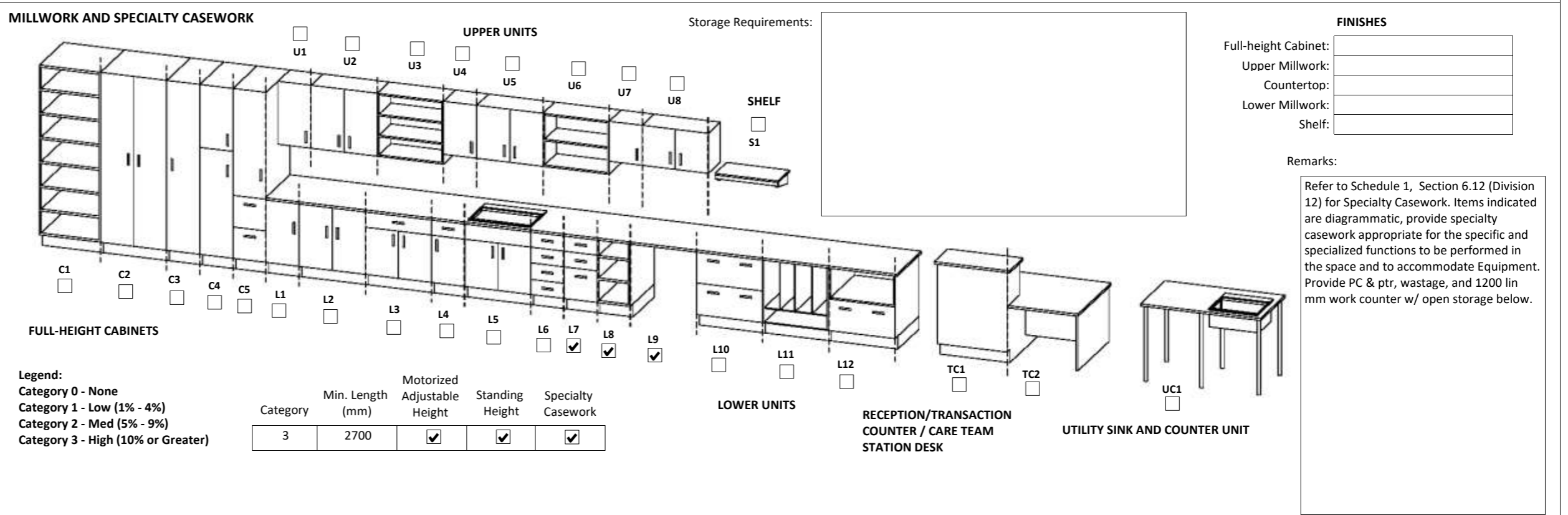

**MECHANICAL REQUIREMENTS**

<b>PLUMBING</b> (Quantity) Hygiene Sink: <input type="text"/> Lavatory: <input type="text"/> Kitchen Sink: <input type="text"/> Seamless Kitchen Sink: <input type="text"/> Utility / Process Sink: <input type="text"/> Scrub Sink: <input type="text"/> Floor Sink: <input type="text"/>							Other Fixtures: <input type="checkbox"/> Shower <input type="checkbox"/> Eyewash Station <input type="checkbox"/> Tub <input type="checkbox"/> Eyewash/Shower Station <input type="checkbox"/> Ice Maker <input type="checkbox"/> Emergency Shower <input type="checkbox"/> Water Closet <input type="checkbox"/> Flush Rim Sink <input type="checkbox"/> Instantaneous Hot Water <input type="checkbox"/> Floor Drain <input type="checkbox"/> <input type="checkbox"/> Water Bottle Refill Station Other: <input type="text"/>				<b>MED / NON-MED GASES</b> (Quantity) Oxygen: <input type="text"/> Medical Air: <input type="text"/> Medical Vacuum: <input type="text"/> Nitrous Oxide: <input type="text"/> CO2: <input type="text"/> AGSS: <input type="text"/> Nitrogen: <input type="text"/> Laboratory Air: <input type="text"/> Laboratory Vacuum: <input type="text"/> Utility Compressed Air: <input type="text"/>					
Plumbing Remarks: <input type="text"/>							Gas Remarks: <input type="text"/>									

**Appendix 1B Minimum Room Requirements**

Room Name:

Program Number(s):

1. R1.02.01	7.	13.	19.	25.	31.	37.	43.
2.	8.	14.	20.	26.	32.	38.	44.
3.	9.	15.	21.	27.	33.	39.	45.
4.	10.	16.	22.	28.	34.	40.	46.
5.	11.	17.	23.	29.	35.	41.	47.
6.	12.	18.	24.	30.	36.	42.	48.

**ARCHITECTURAL REQUIREMENTS**

<b>WALL AND CEILING</b> Wall Material: <input type="text" value="MMRGB"/> Finish: <input type="text" value="PT"/> Ceiling Material: <input type="text" value="ACT"/> Finish: <input type="text" value="PF"/>	<b>WALL PROTECTION</b> Type: <input type="text" value="RHIS"/> <input checked="" type="checkbox"/> Corner Guards <input type="checkbox"/> Hand Rails <input type="checkbox"/> Bed Bumper / Locator Height: <input type="text" value="2185 mm"/> <input checked="" type="checkbox"/> Crash Rails <input type="checkbox"/> Chair Rail	<b>GLAZING</b> <input checked="" type="checkbox"/> Interior Glazing	<b>FLOORING TYPES</b> Material: <input type="text" value="VSF"/> Base: <input type="text" value="FCB"/>	<b>ROOM ACCESSORIES</b> <input type="checkbox"/> Coat Hooks <input type="checkbox"/> Ceiling Lift <input type="checkbox"/> Magnetic Whiteboard <input type="checkbox"/> Mirror <input type="checkbox"/> Infant Change Table <input type="checkbox"/> Privacy Curtain
--	---	--	--	--

- LEGEND:**
- WALL AND CEILING LEGEND:**
- AC Architectural Ceiling
  - ACT Acoustic Ceiling Tile
  - ACT-C Cleanroom
  - ARGB Abuse-Resistant Gypsum Board
  - GB Gypsum Board
  - IRGB Impact-Resistant Gypsum Board
  - KLCT Kitchen Lay-in Ceiling Tile
  - MMRGB Moisture and Mould-Resistant Gypsum Board
  - SACT Security Acoustic Ceiling Tile
- WALL FINISHES LEGEND:**
- EWC Epoxy Wall Coating
  - HPC High Performance Coating
  - PT Paint
- CEILING FINISHES LEGEND:**
- ECC Epoxy Ceiling Coating
  - HPC High Performance Coating
  - PF Prefinished
  - PT Paint
- WALL PROTECTION LEGEND:**
- ESRP Extruded Semi-Rigid PVCu Panel
  - FRL Fibre Reinforced Laminate
  - FRP Fibreglass Reinforced Plastic
  - PVV Protective Vinyl Wallcovering
  - RHIS Rigid High Impact Sheet
  - WSSP Wetwall Solid Surface Panel
  - WVV Wetroom Vinyl Wallcovering
- FLOOR FINISHES LEGEND:**
- CFS Concrete Floor Sealer
  - EFC Epoxy Floor Coating
  - PFC Polyurethane Floor Coating
  - RAF Rubber Athletic Flooring
  - RSF Rubber Sheet Flooring
  - SCF Seamless Cushioned Flooring
  - SDRF Static-Dissipative Rubber Sheet Flooring
  - SDVF Static-Dissipative Vinyl Sheet Flooring
  - VSF Vinyl Sheet Flooring
  - WSVF Wetroom Safety Vinyl Sheet Flooring
- FLOOR BASE LEGEND:**
- FCB Flash Cove Base
  - RB Rubber Base
  - SCF Seamless Cushioned Flooring

**DOORS**

Types:

Type	Qty	Size (mm)	Material	Finish	Side Lt.	Blinds	Protect.	Privacy Film	Function	Card Reader	Mag Lock	Auto Opener	Hold Open	Hinges	Accessory 1	Accessory 2	Accessory 3	Closer

Door Remarks:  Security Grille  Anti-barricade strategy

**MILLWORK AND SPECIALTY CASEWORK**

**UPPER UNITS** (U1-U8) **LOWER UNITS** (L1-L12) **SHELF** (S1) **RECEPTION/TRANSACTION COUNTER / CARE TEAM STATION DESK** (TC1, TC2) **UTILITY SINK AND COUNTER UNIT** (UC1)

Storage Requirements:

**FINISHES**

Full-height Cabinet:   
 Upper Millwork:   
 Countertop:   
 Lower Millwork:   
 Shelf:

Remarks:

Category	Min. Length (mm)	Motorized Adjustable Height	Standing Height	Specialty Casework
3	1500	<input checked="" type="checkbox"/>	<input checked="" type="checkbox"/>	<input type="checkbox"/>

**MECHANICAL REQUIREMENTS**

<b>PLUMBING</b> (Quantity) Hand Hygiene Sink: <input type="text" value="1"/> Lavatory: <input type="text"/> Kitchen Sink: <input type="text"/> Seamless Kitchen Sink: <input type="text"/> Utility / Process Sink: <input type="text"/> Scrub Sink: <input type="text"/> Floor Sink: <input type="text"/> Plumbing Remarks: <input type="text"/>	Other Fixtures: <input type="checkbox"/> Shower <input type="checkbox"/> Tub <input type="checkbox"/> Ice Maker <input type="checkbox"/> Water Closet <input type="checkbox"/> Instantaneous Hot Water <input type="checkbox"/> Eyewash Station <input type="checkbox"/> Eyewash/Shower Station <input type="checkbox"/> Emergency Shower <input type="checkbox"/> Flush Rim Sink <input type="checkbox"/> Floor Drain <input type="checkbox"/> Water Bottle Refill Station Other: <input type="text"/>	<b>MED / NON-MED GASES</b> (Quantity) Oxygen: <input type="text"/> Medical Air: <input type="text"/> Medical Vacuum: <input type="text"/> Nitrous Oxide: <input type="text"/> CO2: <input type="text"/> AGSS: <input type="text"/> Nitrogen: <input type="text"/> Laboratory Air: <input type="text"/> Laboratory Vacuum: <input type="text"/> Utility Compressed Air: <input type="text"/> Gas Remarks: <input type="text"/>
--	--	---



**Appendix 1B Minimum Room Requirements**

Room Name:

Program Number(s):

1.	R3.06	7.		13.		19.		25.		31.		37.		43.
2.		8.		14.		20.		26.		32.		38.		44.
3.		9.		15.		21.		27.		33.		39.		45.
4.		10.		16.		22.		28.		34.		40.		46.
5.		11.		17.		23.		29.		35.		41.		47.
6.		12.		18.		24.		30.		36.		42.		48.

**ARCHITECTURAL REQUIREMENTS**

<b>WALL AND CEILING</b> Wall Material: <input type="text" value="ARGB 1.2m AFF, GB above"/> Finish: <input type="text" value="EWC"/> Ceiling Material: <input type="text" value="GB"/> Finish: <input type="text" value="ECC"/>		<b>WALL PROTECTION</b> Type: <input type="text" value="ESRP"/> <input type="checkbox"/> Corner Guards <input type="checkbox"/> Hand Rails <input type="checkbox"/> Bed Bumper / Locator Height: <input type="text" value="2185 mm"/> <input type="checkbox"/> Crash Rails <input type="checkbox"/> Chair Rail			<b>GLAZING</b> <input type="checkbox"/> Interior Glazing		<b>FLOORING TYPES</b> Material: <input type="text" value="VSF"/> Base: <input type="text" value="FCB"/>		<b>ROOM ACCESSORIES</b> <input type="checkbox"/> Coat Hooks <input type="checkbox"/> Ceiling Lift <input type="checkbox"/> Magnetic Whiteboard <input type="checkbox"/> Mirror <input type="checkbox"/> Infant Change Table <input type="checkbox"/> Privacy Curtain		
---	--	---	--	--	---	--	--	--	--	--	--

- LEGEND:**
- WALL AND CEILING LEGEND:**
- AC Architectural Ceiling
  - ACT Acoustic Ceiling Tile
  - ACT-C Cleanroom
  - ARGB Abuse-Resistant Gypsum Board
  - GB Gypsum Board
  - IRGB Impact-Resistant Gypsum Board
  - KLCT Kitchen Lay-in Ceiling Tile
  - MMRGB Moisture and Mould-Resistant Gypsum Board
  - SACT Security Acoustic Ceiling Tile
- WALL FINISHES LEGEND:**
- EWC Epoxy Wall Coating
  - HPC High Performance Coating
  - PT Paint
- CEILING FINISHES LEGEND:**
- ECC Epoxy Ceiling Coating
  - HPC High Performance Coating
  - PF Prefinished
  - PT Paint
- WALL PROTECTION LEGEND:**
- ESRP Extruded Semi-Rigid PVCu Panel
  - FRL Fibre Reinforced Laminate
  - FRP Fibreglass Reinforced Plastic
  - PVV Protective Vinyl Wallcovering
  - RHIS Rigid High Impact Sheet
  - WSSP Wetwall Solid Surface Panel
  - WVV Wetroom Vinyl Wallcovering
- FLOOR FINISHES LEGEND:**
- CFS Concrete Floor Sealer
  - EFC Epoxy Floor Coating
  - PFC Polyurethane Floor Coating
  - RAF Rubber Athletic Flooring
  - RSF Rubber Sheet Flooring
  - SCF Seamless Cushioned Flooring
  - SDRF Static-Dissipative Rubber Sheet Flooring
  - SDVF Static-Dissipative Vinyl Sheet Flooring
  - VSF Vinyl Sheet Flooring
  - WSVF Wetroom Safety Vinyl Sheet Flooring
- FLOOR BASE LEGEND:**
- FCB Flash Cove Base
  - RB Rubber Base
  - SCF Seamless Cushioned Flooring

**DOORS**

Types:

Type	Qty	Size (mm)	Material	Finish	Side Lt.	Blinds	Protect.	Privacy Film	Function	Card Reader	Mag Lock	Auto Opener	Hold Open	Hinges	Accessory 1	Accessory 2	Accessory 3	Closer
C	1	1220 x 2135	Solid Core	FRL	<input type="checkbox"/>	<input type="checkbox"/>	2 High	<input checked="" type="checkbox"/>	Storeroom	<input type="checkbox"/>	<input type="checkbox"/>	<input checked="" type="checkbox"/>	<input checked="" type="checkbox"/>	Butt Hinge	Elec. Strike			Concealed

Door Remarks:  Security Grille  Anti-barricade strategy

Provide wave openers on doors.

**MILLWORK AND SPECIALTY CASEWORK**

Storage Requirements:

**UPPER UNITS** (U1-U8) **SHELF** (S1)

**FULL-HEIGHT CABINETS** (C1-C5) **LOWER UNITS** (L1-L12) **RECEPTION/TRANSACTION COUNTER / CARE TEAM STATION DESK** (TC1-TC2) **UTILITY SINK AND COUNTER UNIT** (UC1)

Category	Min. Length (mm)	Motorized Adjustable Height	Standing Height	Specialty Casework
Category 0 - None		<input type="checkbox"/>	<input type="checkbox"/>	<input type="checkbox"/>
Category 1 - Low (1% - 4%)		<input type="checkbox"/>	<input type="checkbox"/>	<input type="checkbox"/>
Category 2 - Med (5% - 9%)		<input type="checkbox"/>	<input type="checkbox"/>	<input type="checkbox"/>
Category 3 - High (10% or Greater)		<input type="checkbox"/>	<input type="checkbox"/>	<input type="checkbox"/>

**FINISHES**

Full-height Cabinet:   
 Upper Millwork:   
 Countertop:   
 Lower Millwork:   
 Shelf:

Remarks:  Provide ceiling hatches with gaskets.

**MECHANICAL REQUIREMENTS**

<b>PLUMBING</b> (Quantity) Hand Hygiene Sink: <input type="text"/> Lavatory: <input type="text"/> Kitchen Sink: <input type="text"/> Seamless Kitchen Sink: <input type="text"/> Utility / Process Sink: <input type="text"/> Scrub Sink: <input type="text"/> Floor Sink: <input type="text"/>							Other Fixtures: <input type="checkbox"/> Shower <input type="checkbox"/> Tub <input type="checkbox"/> Ice Maker <input type="checkbox"/> Water Closet <input type="checkbox"/> Instantaneous Hot Water			<input type="checkbox"/> Eyewash Station <input type="checkbox"/> Eyewash/Shower Station <input type="checkbox"/> Emergency Shower <input type="checkbox"/> Flush Rim Sink <input type="checkbox"/> Floor Drain <input type="checkbox"/> Water Bottle Refill Station			<b>MED / NON-MED GASES</b> (Quantity) Oxygen: <input type="text"/> Medical Air: <input type="text"/> Medical Vacuum: <input type="text"/> Nitrous Oxide: <input type="text"/> CO2: <input type="text"/> AGSS: <input type="text"/> Nitrogen: <input type="text"/> Laboratory Air: <input type="text"/> Laboratory Vacuum: <input type="text"/> Utility Compressed Air: <input type="text"/>					
Plumbing Remarks: <input type="text"/>							Gas Remarks: <input type="text"/>											

**Appendix 1B Minimum Room Requirements**

Room Name:

Program Number(s):

1.	R1.01	7.		13.		19.		25.		31.		37.		43.
2.		8.		14.		20.		26.		32.		38.		44.
3.		9.		15.		21.		27.		33.		39.		45.
4.		10.		16.		22.		28.		34.		40.		46.
5.		11.		17.		23.		29.		35.		41.		47.
6.		12.		18.		24.		30.		36.		42.		48.

**ARCHITECTURAL REQUIREMENTS**

<b>WALL AND CEILING</b> Wall Material: <input type="text" value="MMRGB"/> Finish: <input type="text" value="PT"/> Ceiling Material: <input type="text" value="ACT"/> Finish: <input type="text" value="PF"/>		<b>WALL PROTECTION</b> Type: <input type="text" value="RHIS"/> <input checked="" type="checkbox"/> Corner Guards <input type="checkbox"/> Hand Rails <input type="checkbox"/> Bed Bumper / Locator Height: <input type="text" value="2185 mm"/> <input checked="" type="checkbox"/> Crash Rails <input type="checkbox"/> Chair Rail		<b>GLAZING</b> <input checked="" type="checkbox"/> Interior Glazing		<b>FLOORING TYPES</b> Material: <input type="text" value="VSF"/> Base: <input type="text" value="FCB"/>		<b>ROOM ACCESSORIES</b> <input type="checkbox"/> Coat Hooks <input type="checkbox"/> Ceiling Lift <input type="checkbox"/> Magnetic Whiteboard <input type="checkbox"/> Mirror <input type="checkbox"/> Infant Change Table <input type="checkbox"/> Privacy Curtain		
--	--	---	--	--	--	--	--	--	--	--

- LEGEND:**
- WALL AND CEILING LEGEND:**
- AC Architectural Ceiling
  - ACT Acoustic Ceiling Tile
  - ACT-C Cleanroom
  - ARGB Abuse-Resistant Gypsum Board
  - GB Gypsum Board
  - IRGB Impact-Resistant Gypsum Board
  - KLCT Kitchen Lay-in Ceiling Tile
  - MMRGB Moisture and Mould-Resistant Gypsum Board
  - SACT Security Acoustic Ceiling Tile
- WALL FINISHES LEGEND:**
- EWC Epoxy Wall Coating
  - HPC High Performance Coating
  - PT Paint
- CEILING FINISHES LEGEND:**
- ECC Epoxy Ceiling Coating
  - HPC High Performance Coating
  - PF Prefinished
  - PT Paint
- WALL PROTECTION LEGEND:**
- ESRP Extruded Semi-Rigid PVCu Panel
  - FRL Fibre Reinforced Laminate
  - FRP Fibreglass Reinforced Plastic
  - PVV Protective Vinyl Wallcovering
  - RHIS Rigid High Impact Sheet
  - WSSP Wetwall Solid Surface Panel
  - WVV Wetroom Vinyl Wallcovering
- FLOOR FINISHES LEGEND:**
- CFS Concrete Floor Sealer
  - EFC Epoxy Floor Coating
  - PFC Polyurethane Floor Coating
  - RAF Rubber Athletic Flooring
  - RSF Rubber Sheet Flooring
  - SCF Seamless Cushioned Flooring
  - SDRF Static-Dissipative Rubber Sheet Flooring
  - SDVF Static-Dissipative Vinyl Sheet Flooring
  - VSF Vinyl Sheet Flooring
  - WSVF Wetroom Safety Vinyl Sheet Flooring
- FLOOR BASE LEGEND:**
- FCB Flash Cove Base
  - RB Rubber Base
  - SCF Seamless Cushioned Flooring

**DOORS**

Types:

Type	Qty	Size (mm)	Material	Finish	Side Lt.	Blinds	Protect.	Privacy Film	Function	Card Reader	Mag Lock	Auto Opener	Hold Open	Hinges	Accessory 1	Accessory 2	Accessory 3	Closer
C	1	1220 x 2135	Hollow Metal	Paint	<input type="checkbox"/>	<input type="checkbox"/>		<input checked="" type="checkbox"/>	Classroom	<input type="checkbox"/>	<input type="checkbox"/>	<input type="checkbox"/>	<input checked="" type="checkbox"/>	Butt Hinge				Surface
C	1	1065 x 2135	Hollow Metal	Paint	<input type="checkbox"/>	<input type="checkbox"/>		<input type="checkbox"/>	Storeroom	<input checked="" type="checkbox"/>	<input type="checkbox"/>	<input type="checkbox"/>	<input checked="" type="checkbox"/>	Butt Hinge				Surface

Door Remarks:  Security Grille  Anti-barricade strategy

Provide keypad card reader to public door



**MECHANICAL REQUIREMENTS**

<b>PLUMBING</b> (Quantity) Hand Hygiene Sink: <input type="text"/> Lavatory: <input type="text"/> Kitchen Sink: <input type="text"/> Seamless Kitchen Sink: <input type="text"/> Utility / Process Sink: <input type="text"/> Scrub Sink: <input type="text"/> Floor Sink: <input type="text"/>							Other Fixtures: <input type="checkbox"/> Shower <input type="checkbox"/> Eyewash Station <input type="checkbox"/> Tub <input type="checkbox"/> Eyewash/Shower Station <input type="checkbox"/> Ice Maker <input type="checkbox"/> Emergency Shower <input type="checkbox"/> Water Closet <input type="checkbox"/> Flush Rim Sink <input type="checkbox"/> Instantaneous Hot Water <input type="checkbox"/> Floor Drain <input type="checkbox"/> <input type="checkbox"/> Water Bottle Refill Station Other <input type="text"/>				<b>MED / NON-MED GASES</b> (Quantity) Oxygen: <input type="text"/> Medical Air: <input type="text"/> Medical Vacuum: <input type="text"/> Nitrous Oxide: <input type="text"/> CO2: <input type="text"/> AGSS: <input type="text"/> Nitrogen: <input type="text"/> Laboratory Air: <input type="text"/> Laboratory Vacuum: <input type="text"/> Utility Compressed Air: <input type="text"/>					
Plumbing Remarks: <input type="text"/>											Gas Remarks: <input type="text"/>					

---

# New Surrey Hospital & BC Cancer Centre

MINIMUM ROOM REQUIREMENTS

**S. Virtual Health**

---



**Appendix 1B Minimum Room Requirements**

Room Name:

Program Number(s):

1. S1.01	7.	13.	19.	25.	31.	37.	43.
2.	8.	14.	20.	26.	32.	38.	44.
3.	9.	15.	21.	27.	33.	39.	45.
4.	10.	16.	22.	28.	34.	40.	46.
5.	11.	17.	23.	29.	35.	41.	47.
6.	12.	18.	24.	30.	36.	42.	48.

**ARCHITECTURAL REQUIREMENTS**

<b>WALL AND CEILING</b> Wall Material: <input type="text" value="GB"/> Finish: <input type="text" value="PT"/> Ceiling Material: <input type="text" value="ACT"/> Finish: <input type="text" value="PF"/>	<b>WALL PROTECTION</b> Type: <input type="text" value="RHIS"/> <input checked="" type="checkbox"/> Corner Guards <input type="checkbox"/> Hand Rails <input type="checkbox"/> Bed Bumper / Locator Height: <input type="text" value="1350 mm"/> <input type="checkbox"/> Crash Rails <input checked="" type="checkbox"/> Chair Rail	<b>GLAZING</b> <input type="checkbox"/> Interior Glazing	<b>FLOORING TYPES</b> Material: <input type="text" value="RSF"/> Base: <input type="text" value="RB"/>	<b>ROOM ACCESSORIES</b> <input type="checkbox"/> Coat Hooks <input type="checkbox"/> Ceiling Lift <input type="checkbox"/> Magnetic Whiteboard <input type="checkbox"/> Mirror <input type="checkbox"/> Infant Change Table <input type="checkbox"/> Privacy Curtain
---	---	---	---	--

- LEGEND:**
- WALL AND CEILING LEGEND:**
- AC Architectural Ceiling
  - ACT Acoustic Ceiling Tile
  - ACT-C Cleanroom
  - ARGB Abuse-Resistant Gypsum Board
  - GB Gypsum Board
  - IRGB Impact-Resistant Gypsum Board
  - KLCT Kitchen Lay-in Ceiling Tile
  - MMRGB Moisture and Mould-Resistant Gypsum Board
  - SACT Security Acoustic Ceiling Tile
- WALL FINISHES LEGEND:**
- EWC Epoxy Wall Coating
  - HPC High Performance Coating
  - PT Paint
- CEILING FINISHES LEGEND:**
- ECC Epoxy Ceiling Coating
  - HPC High Performance Coating
  - PF Prefinished
  - PT Paint
- WALL PROTECTION LEGEND:**
- ESRP Extruded Semi-Rigid PVCu Panel
  - FRL Fibre Reinforced Laminate
  - FRP Fibreglass Reinforced Plastic
  - PVV Protective Vinyl Wallcovering
  - RHIS Rigid High Impact Sheet
  - WSSP Wetwall Solid Surface Panel
  - WVV Wetroom Vinyl Wallcovering
- FLOOR FINISHES LEGEND:**
- CFS Concrete Floor Sealer
  - EFC Epoxy Floor Coating
  - PFC Polyurethane Floor Coating
  - RAF Rubber Athletic Flooring
  - RSF Rubber Sheet Flooring
  - SCF Seamless Cushioned Flooring
  - SDRF Static-Dissipative Rubber Sheet Flooring
  - SDVF Static-Dissipative Vinyl Sheet Flooring
  - VSF Vinyl Sheet Flooring
  - WSVF Wetroom Safety Vinyl Sheet Flooring
- FLOOR BASE LEGEND:**
- FCB Flash Cove Base
  - RB Rubber Base
  - SCF Seamless Cushioned Flooring

**DOORS**

Types:

Type:Qty:	Size (mm):	Material:	Finish:	Side Lt:	Blinds:	Protect.:	Privacy Film:	Function:	Card Reader:	Mag Lock:	Auto Opener:	Hold Open:	Hinges:	Accessory 1:	Accessory 2:	Accessory 3:	Closer:

Door Remarks:  Security Grille  Anti-barricade strategy

**MILLWORK AND SPECIALTY CASEWORK**

Storage Requirements: Refer to Schedule 1 for Digital Device Locker requirements.

**UPPER UNITS** (U1-U8) **SHELF** (S1)

**LOWER UNITS** (L1-L12) **RECEPTION/TRANSACTION COUNTER / CARE TEAM STATION DESK** (TC1-TC2) **UTILITY SINK AND COUNTER UNIT** (UC1)

**FULL-HEIGHT CABINETS** (C1-C5)

**Legend:**

Category	Min. Length (mm)	Motorized Adjustable Height	Standing Height	Specialty Casework
Category 0 - None				
Category 1 - Low (1% - 4%)				
Category 2 - Med (5% - 9%)				
Category 3 - High (10% or Greater)				

**FINISHES**

Full-height Cabinet:   
 Upper Millwork:   
 Countertop:   
 Lower Millwork:   
 Shelf:

Remarks:

**MECHANICAL REQUIREMENTS**

<b>PLUMBING</b> (Quantity) Hand Hygiene Sink: <input type="text"/> Lavatory: <input type="text"/> Kitchen Sink: <input type="text"/> Seamless Kitchen Sink: <input type="text"/> Utility / Process Sink: <input type="text"/> Scrub Sink: <input type="text"/> Floor Sink: <input type="text"/> Plumbing Remarks: <input type="text"/>	Other Fixtures: <input type="checkbox"/> Shower <input type="checkbox"/> Eyewash Station <input type="checkbox"/> Tub <input type="checkbox"/> Eyewash/Shower Station <input type="checkbox"/> Ice Maker <input type="checkbox"/> Emergency Shower <input type="checkbox"/> Water Closet <input type="checkbox"/> Flush Rim Sink <input type="checkbox"/> Instantaneous Hot Water <input type="checkbox"/> Floor Drain <input type="checkbox"/> <input type="checkbox"/> Water Bottle Refill Station Other <input type="text"/>	<b>MED / NON-MED GASES</b> (Quantity) Oxygen: <input type="text"/> Medical Air: <input type="text"/> Medical Vacuum: <input type="text"/> Nitrous Oxide: <input type="text"/> CO2: <input type="text"/> AGSS: <input type="text"/> Nitrogen: <input type="text"/> Laboratory Air: <input type="text"/> Laboratory Vacuum: <input type="text"/> Utility Compressed Air: <input type="text"/> Gas Remarks: <input type="text"/>
---	--	---

---

# New Surrey Hospital & BC Cancer Centre

MINIMUM ROOM REQUIREMENTS

## T. Public Spaces

---

**Appendix 1B Minimum Room Requirements**

Room Name:

Program Number(s):

1. T1.02.07	7.	13.	19.	25.	31.	37.	43.
2.	8.	14.	20.	26.	32.	38.	44.
3.	9.	15.	21.	27.	33.	39.	45.
4.	10.	16.	22.	28.	34.	40.	46.
5.	11.	17.	23.	29.	35.	41.	47.
6.	12.	18.	24.	30.	36.	42.	48.

**ARCHITECTURAL REQUIREMENTS**

<b>WALL AND CEILING</b> Wall Material: <input type="text" value="ARGB 1.2m AFF, GB above"/> Finish: <input type="text" value="PT"/> Ceiling Material: <input type="text" value="ACT"/> Finish: <input type="text" value="PF"/>	<b>WALL PROTECTION</b> Type: <input type="text" value="PVW"/> <input checked="" type="checkbox"/> Corner Guards <input type="checkbox"/> Hand Rails <input type="checkbox"/> Bed Bumper / Locator Height: <input type="text" value="2185 mm"/> <input type="checkbox"/> Crash Rails <input checked="" type="checkbox"/> Chair Rail	<b>GLAZING</b> <input checked="" type="checkbox"/> Interior Glazing	<b>FLOORING TYPES</b> Material: <input type="text" value="VSF"/> Base: <input type="text" value="FCB"/>	<b>ROOM ACCESSORIES</b> <input type="checkbox"/> Coat Hooks <input type="checkbox"/> Ceiling Lift <input type="checkbox"/> Magnetic Whiteboard <input type="checkbox"/> Mirror <input type="checkbox"/> Infant Change Table <input type="checkbox"/> Privacy Curtain
--	--	--	--	--

- LEGEND:**
- WALL AND CEILING LEGEND:**
- AC Architectural Ceiling
  - ACT Acoustic Ceiling Tile
  - ACT-C Cleanroom
  - ARGB Abuse-Resistant Gypsum Board
  - GB Gypsum Board
  - IRGB Impact-Resistant Gypsum Board
  - KLCT Kitchen Lay-in Ceiling Tile
  - MMRGB Moisture and Mould-Resistant Gypsum Board
  - SACT Security Acoustic Ceiling Tile
- WALL FINISHES LEGEND:**
- EWC Epoxy Wall Coating
  - HPC High Performance Coating
  - PT Paint
- CEILING FINISHES LEGEND:**
- ECC Epoxy Ceiling Coating
  - HPC High Performance Coating
  - PF Prefinished
  - PT Paint
- WALL PROTECTION LEGEND:**
- ESRP Extruded Semi-Rigid PVCu Panel
  - FRL Fibre Reinforced Laminate
  - FRP Fibreglass Reinforced Plastic
  - PVW Protective Vinyl Wallcovering
  - RHIS Rigid High Impact Sheet
  - WSSP Wetwall Solid Surface Panel
  - WVV Wetroom Vinyl Wallcovering
- FLOOR FINISHES LEGEND:**
- CFS Concrete Floor Sealer
  - EFC Epoxy Floor Coating
  - PFC Polyurethane Floor Coating
  - RAF Rubber Athletic Flooring
  - RSF Rubber Sheet Flooring
  - SCF Seamless Cushioned Flooring
  - SDRF Static-Dissipative Rubber Sheet Flooring
  - SDVF Static-Dissipative Vinyl Sheet Flooring
  - VSF Vinyl Sheet Flooring
  - WSVF Wetroom Safety Vinyl Sheet Flooring
- FLOOR BASE LEGEND:**
- FCB Flash Cove Base
  - RB Rubber Base
  - SCF Seamless Cushioned Flooring

**DOORS**

Types:

Type	Qty	Size (mm)	Material	Finish	Side Lt.	Blinds	Protect.	Privacy Film	Function	Card Reader	Mag Lock	Auto Opener	Hold Open	Hinges	Accessory 1	Accessory 2	Accessory 3	Closer	

Door Remarks:

Security Grille  
 Anti-barricade strategy

**MILLWORK AND SPECIALTY CASEWORK**

Storage Requirements:

**UPPER UNITS** (U1-U8)

**LOWER UNITS** (L1-L12)

**RECEPTION/TRANSACTION COUNTER / CARE TEAM STATION DESK** (TC1, TC2)

**UTILITY SINK AND COUNTER UNIT** (UC1)

**SHELF** (S1)

**FULL-HEIGHT CABINETS** (C1-C5)

**Legend:**

Category	Min. Length (mm)	Motorized Adjustable Height	Standing Height	Specialty Casework
Category 0 - None				
Category 1 - Low (1% - 4%)				
Category 2 - Med (5% - 9%)				
Category 3 - High (10% or Greater)				

**FINISHES**

Full-height Cabinet:

Upper Millwork:

Countertop:

Lower Millwork:

Shelf:

Remarks:

**MECHANICAL REQUIREMENTS**

<b>PLUMBING</b> (Quantity) Hand Hygiene Sink: <input type="text"/> Lavatory: <input type="text"/> Kitchen Sink: <input type="text"/> Seamless Kitchen Sink: <input type="text"/> Utility / Process Sink: <input type="text"/> Scrub Sink: <input type="text"/> Floor Sink: <input type="text"/> Plumbing Remarks: <input type="text"/>	Other Fixtures: <input type="checkbox"/> Shower <input type="checkbox"/> Tub <input type="checkbox"/> Ice Maker <input type="checkbox"/> Water Closet <input type="checkbox"/> Instantaneous Hot Water <input type="checkbox"/> Eyewash Station <input type="checkbox"/> Eyewash/Shower Station <input type="checkbox"/> Emergency Shower <input type="checkbox"/> Flush Rim Sink <input type="checkbox"/> Floor Drain <input type="checkbox"/> Water Bottle Refill Station Other: <input type="text"/>	<b>MED / NON-MED GASES</b> (Quantity) Oxygen: <input type="text"/> Medical Air: <input type="text"/> Medical Vacuum: <input type="text"/> Nitrous Oxide: <input type="text"/> CO2: <input type="text"/> AGSS: <input type="text"/> Nitrogen: <input type="text"/> Laboratory Air: <input type="text"/> Laboratory Vacuum: <input type="text"/> Utility Compressed Air: <input type="text"/> Gas Remarks: <input type="text"/>
---	---	---



**Appendix 1B Minimum Room Requirements**

Room Name:

Program Number(s):

1. T1.02.03	7.	13.	19.	25.	31.	37.	43.
2.	8.	14.	20.	26.	32.	38.	44.
3.	9.	15.	21.	27.	33.	39.	45.
4.	10.	16.	22.	28.	34.	40.	46.
5.	11.	17.	23.	29.	35.	41.	47.
6.	12.	18.	24.	30.	36.	42.	48.

**ARCHITECTURAL REQUIREMENTS**

<b>WALL AND CEILING</b> Wall Material: <input type="text" value="ARGB 1.2m AFF, GB above"/> Finish: <input type="text" value="PT"/> Ceiling Material: <input type="text" value="ACT"/> Finish: <input type="text" value="PF"/>		<b>WALL PROTECTION</b> Type: <input type="text"/> <input type="checkbox"/> Corner Guards <input type="checkbox"/> Hand Rails <input type="checkbox"/> Bed Bumper / Locator Height: <input type="text"/> <input type="checkbox"/> Crash Rails <input type="checkbox"/> Chair Rail			<b>GLAZING</b> <input checked="" type="checkbox"/> Interior Glazing		<b>FLOORING TYPES</b> Material: <input type="text" value="VSF"/> Base: <input type="text" value="FCB"/>		<b>ROOM ACCESSORIES</b> <input type="checkbox"/> Coat Hooks <input type="checkbox"/> Ceiling Lift <input type="checkbox"/> Magnetic Whiteboard <input type="checkbox"/> Mirror <input type="checkbox"/> Infant Change Table <input type="checkbox"/> Privacy Curtain		
--	--	--	--	--	--	--	--	--	--	--	--

- LEGEND:**
- WALL AND CEILING LEGEND:**
- AC Architectural Ceiling
  - ACT Acoustic Ceiling Tile
  - ACT-C Cleanroom
  - ARGB Abuse-Resistant Gypsum Board
  - GB Gypsum Board
  - IRGB Impact-Resistant Gypsum Board
  - KLCT Kitchen Lay-in Ceiling Tile
  - MMRGB Moisture and Mould-Resistant Gypsum Board
  - SACT Security Acoustic Ceiling Tile
- WALL FINISHES LEGEND:**
- EWC Epoxy Wall Coating
  - HPC High Performance Coating
  - PT Paint
- CEILING FINISHES LEGEND:**
- ECC Epoxy Ceiling Coating
  - HPC High Performance Coating
  - PF Prefinished
  - PT Paint
- WALL PROTECTION LEGEND:**
- ESRP Extruded Semi-Rigid PVCu Panel
  - FRL Fibre Reinforced Laminate
  - FRP Fibreglass Reinforced Plastic
  - PVV Protective Vinyl Wallcovering
  - RHIS Rigid High Impact Sheet
  - WSSP Wetwall Solid Surface Panel
  - WVV Wetroom Vinyl Wallcovering
- FLOOR FINISHES LEGEND:**
- CFS Concrete Floor Sealer
  - EFC Epoxy Floor Coating
  - PFC Polyurethane Floor Coating
  - RAF Rubber Athletic Flooring
  - RSF Rubber Sheet Flooring
  - SCF Seamless Cushioned Flooring
  - SDRF Static-Dissipative Rubber Sheet Flooring
  - SDVF Static-Dissipative Vinyl Sheet Flooring
  - VSF Vinyl Sheet Flooring
  - WSVF Wetroom Safety Vinyl Sheet Flooring
- FLOOR BASE LEGEND:**
- FCB Flash Cove Base
  - RB Rubber Base
  - SCF Seamless Cushioned Flooring

**DOORS**

Types:

Type	Qty	Size (mm)	Material	Finish	Side Lt.	Blinds	Protect.	Privacy Film	Function	Card Reader	Mag Lock	Auto Opener	Hold Open	Hinges	Accessory 1	Accessory 2	Accessory 3	Closer

Door Remarks:  Security Grille  Anti-barricade strategy

**MILLWORK AND SPECIALTY CASEWORK**

Storage Requirements:

**UPPER UNITS** (U1-U8) **SHELF** (S1)

**FULL-HEIGHT CABINETS** (C1-C5) **LOWER UNITS** (L1-L12) **RECEPTION/TRANSACTION COUNTER / CARE TEAM STATION DESK** (TC1-TC2) **UTILITY SINK AND COUNTER UNIT** (UC1)

Category	Min. Length (mm)	Motorized Adjustable Height	Standing Height	Specialty Casework
Category 0 - None				
Category 1 - Low (1% - 4%)				
Category 2 - Med (5% - 9%)				
Category 3 - High (10% or Greater)				

**FINISHES**

Full-height Cabinet:   
 Upper Millwork:   
 Countertop:   
 Lower Millwork:   
 Shelf:

Remarks:

**MECHANICAL REQUIREMENTS**

<b>PLUMBING</b> (Quantity) Hand Hygiene Sink: <input type="text"/> Lavatory: <input type="text"/> Kitchen Sink: <input type="text"/> Seamless Kitchen Sink: <input type="text"/> Utility / Process Sink: <input type="text"/> Scrub Sink: <input type="text"/> Floor Sink: <input type="text"/>							Other Fixtures: <input type="checkbox"/> Shower <input type="checkbox"/> Eyewash Station <input type="checkbox"/> Tub <input type="checkbox"/> Eyewash/Shower Station <input type="checkbox"/> Ice Maker <input type="checkbox"/> Emergency Shower <input type="checkbox"/> Water Closet <input type="checkbox"/> Flush Rim Sink <input type="checkbox"/> Instantaneous Hot Water <input type="checkbox"/> Floor Drain <input type="checkbox"/> Water Bottle Refill Station Other: <input type="text"/>				<b>MED / NON-MED GASES</b> (Quantity) Oxygen: <input type="text"/> Medical Air: <input type="text"/> Medical Vacuum: <input type="text"/> Nitrous Oxide: <input type="text"/> CO2: <input type="text"/> AGSS: <input type="text"/> Nitrogen: <input type="text"/> Laboratory Air: <input type="text"/> Laboratory Vacuum: <input type="text"/> Utility Compressed Air: <input type="text"/>					
Plumbing Remarks: <input type="text"/>											Gas Remarks: <input type="text"/>					

**Appendix 1B Minimum Room Requirements**

Room Name:

Program Number(s):

1. T4.02	7.	13.	19.	25.	31.	37.	43.
2.	8.	14.	20.	26.	32.	38.	44.
3.	9.	15.	21.	27.	33.	39.	45.
4.	10.	16.	22.	28.	34.	40.	46.
5.	11.	17.	23.	29.	35.	41.	47.
6.	12.	18.	24.	30.	36.	42.	48.

**ARCHITECTURAL REQUIREMENTS**

<b>WALL AND CEILING</b> Wall Material: <input type="text" value="ARGB 1.2m AFF, GB above"/> Finish: <input type="text" value="PT"/> Ceiling Material: <input type="text" value="ACT"/> Finish: <input type="text" value="PF"/>	<b>WALL PROTECTION</b> Type: <input type="text" value="FRL"/> <input type="checkbox"/> Corner Guards <input type="checkbox"/> Hand Rails <input type="checkbox"/> Bed Bumper / Locator Height: <input type="text" value="1350 mm"/> <input type="checkbox"/> Crash Rails <input type="checkbox"/> Chair Rail	<b>GLAZING</b> <input checked="" type="checkbox"/> Interior Glazing	<b>FLOORING TYPES</b> Material: <input type="text" value="VSF"/> Base: <input type="text" value="RB"/>	<b>ROOM ACCESSORIES</b> <input checked="" type="checkbox"/> Coat Hooks <input type="checkbox"/> Ceiling Lift <input checked="" type="checkbox"/> Magnetic Whiteboard <input type="checkbox"/> Mirror <input type="checkbox"/> Infant Change Table <input type="checkbox"/> Privacy Curtain
--	--	--	---	--

- LEGEND:**
- WALL AND CEILING LEGEND:**
- AC Architectural Ceiling
  - ACT Acoustic Ceiling Tile
  - ACT-C Cleanroom
  - ARGB Abuse-Resistant Gypsum Board
  - GB Gypsum Board
  - IRGB Impact-Resistant Gypsum Board
  - KLCT Kitchen Lay-in Ceiling Tile
  - MMRGB Moisture and Mould-Resistant Gypsum Board
  - SACT Security Acoustic Ceiling Tile
- WALL FINISHES LEGEND:**
- EWC Epoxy Wall Coating
  - HPC High Performance Coating
  - PT Paint
- CEILING FINISHES LEGEND:**
- ECC Epoxy Ceiling Coating
  - HPC High Performance Coating
  - PF Prefinished
  - PT Paint
- WALL PROTECTION LEGEND:**
- ESRP Extruded Semi-Rigid PVCu Panel
  - FRL Fibre Reinforced Laminate
  - FRP Fibreglass Reinforced Plastic
  - PVV Protective Vinyl Wallcovering
  - RHIS Rigid High Impact Sheet
  - WSSP Wetwall Solid Surface Panel
  - WVV Wetroom Vinyl Wallcovering
- FLOOR FINISHES LEGEND:**
- CFS Concrete Floor Sealer
  - EFC Epoxy Floor Coating
  - PFC Polyurethane Floor Coating
  - RAF Rubber Athletic Flooring
  - RSF Rubber Sheet Flooring
  - SCF Seamless Cushioned Flooring
  - SDRF Static-Dissipative Rubber Sheet Flooring
  - SDVF Static-Dissipative Vinyl Sheet Flooring
  - VSF Vinyl Sheet Flooring
  - WSVF Wetroom Safety Vinyl Sheet Flooring
- FLOOR BASE LEGEND:**
- FCB Flash Cove Base
  - RB Rubber Base
  - SCF Seamless Cushioned Flooring

**DOORS**

Types:

Type	Qty	Size (mm)	Material	Finish	Side Lt.	Blinds	Protect.	Privacy Film	Function	Card Reader	Mag Lock	Auto Opener	Hold Open	Hinges	Accessory 1	Accessory 2	Accessory 3	Closer
C	1	1065 x 2135	Solid Core	FRL	<input type="checkbox"/>	<input checked="" type="checkbox"/>	1 Low	<input type="checkbox"/>	Classroom	<input type="checkbox"/>	<input type="checkbox"/>	<input type="checkbox"/>	<input checked="" type="checkbox"/>	Butt Hinge				Surface

Door Remarks:  Security Grille  Anti-barricade strategy

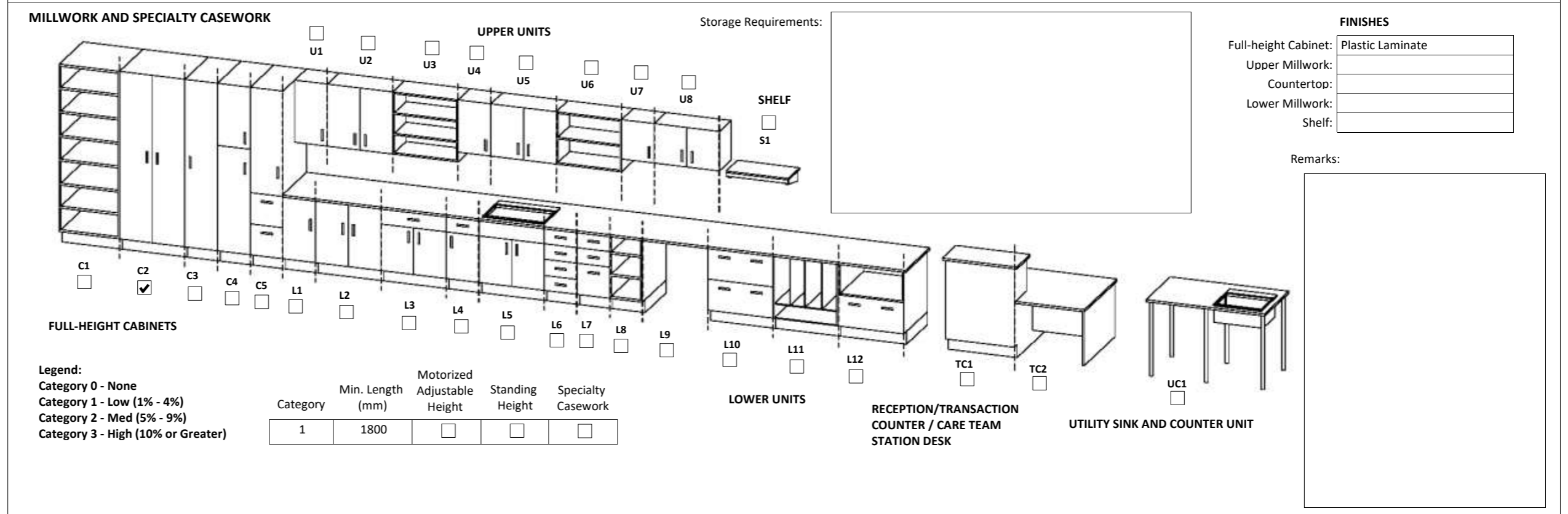

**MECHANICAL REQUIREMENTS**

<b>PLUMBING</b> (Quantity) Hand Hygiene Sink: <input type="text"/> Lavatory: <input type="text"/> Kitchen Sink: <input type="text"/> Seamless Kitchen Sink: <input type="text"/> Utility / Process Sink: <input type="text"/> Scrub Sink: <input type="text"/> Floor Sink: <input type="text"/> Plumbing Remarks: <input type="text"/>	Other Fixtures: <input type="checkbox"/> Shower <input type="checkbox"/> Eyewash Station <input type="checkbox"/> Tub <input type="checkbox"/> Eyewash/Shower Station <input type="checkbox"/> Ice Maker <input type="checkbox"/> Emergency Shower <input type="checkbox"/> Water Closet <input type="checkbox"/> Flush Rim Sink <input type="checkbox"/> Instantaneous Hot Water <input type="checkbox"/> Floor Drain <input type="checkbox"/> Water Bottle Refill Station Other: <input type="text"/>	<b>MED / NON-MED GASES</b> (Quantity) Oxygen: <input type="text"/> Medical Air: <input type="text"/> Medical Vacuum: <input type="text"/> Nitrous Oxide: <input type="text"/> CO2: <input type="text"/> AGSS: <input type="text"/> Nitrogen: <input type="text"/> Laboratory Air: <input type="text"/> Laboratory Vacuum: <input type="text"/> Utility Compressed Air: <input type="text"/> Gas Remarks: <input type="text"/>
---	--	---

**Appendix 1B Minimum Room Requirements**

Room Name:

Program Number(s):

1. T1.02.04	7.	13.	19.	25.	31.	37.	43.
2.	8.	14.	20.	26.	32.	38.	44.
3.	9.	15.	21.	27.	33.	39.	45.
4.	10.	16.	22.	28.	34.	40.	46.
5.	11.	17.	23.	29.	35.	41.	47.
6.	12.	18.	24.	30.	36.	42.	48.

**ARCHITECTURAL REQUIREMENTS**

<b>WALL AND CEILING</b> Wall Material: <input type="text" value="GB"/> Finish: <input type="text" value="PT"/> Ceiling Material: <input type="text" value="ACT"/> Finish: <input type="text" value="PF"/>	<b>WALL PROTECTION</b> Type: <input type="text"/> Height: <input type="text"/> <input type="checkbox"/> Corner Guards <input type="checkbox"/> Hand Rails <input type="checkbox"/> Bed Bumper / Locator <input type="checkbox"/> Crash Rails <input type="checkbox"/> Chair Rail	<b>GLAZING</b> <input checked="" type="checkbox"/> Interior Glazing	<b>FLOORING TYPES</b> Material: <input type="text" value="VSF"/> Base: <input type="text" value="FCB"/>	<b>ROOM ACCESSORIES</b> <input type="checkbox"/> Coat Hooks <input type="checkbox"/> Ceiling Lift <input checked="" type="checkbox"/> Magnetic Whiteboard <input type="checkbox"/> Mirror <input type="checkbox"/> Infant Change Table <input type="checkbox"/> Privacy Curtain
---	---	--	--	---

- LEGEND:**
- WALL AND CEILING LEGEND:**
- AC Architectural Ceiling
  - ACT Acoustic Ceiling Tile
  - ACT-C Cleanroom
  - ARGB Abuse-Resistant Gypsum Board
  - GB Gypsum Board
  - IRGB Impact-Resistant Gypsum Board
  - KLCT Kitchen Lay-in Ceiling Tile
  - MMRGB Moisture and Mould-Resistant Gypsum Board
  - SACT Security Acoustic Ceiling Tile
- WALL FINISHES LEGEND:**
- EWC Epoxy Wall Coating
  - HPC High Performance Coating
  - PT Paint
- CEILING FINISHES LEGEND:**
- ECC Epoxy Ceiling Coating
  - HPC High Performance Coating
  - PF Prefinished
  - PT Paint
- WALL PROTECTION LEGEND:**
- ESRP Extruded Semi-Rigid PVCu Panel
  - FRL Fibre Reinforced Laminate
  - FRP Fibreglass Reinforced Plastic
  - PVV Protective Vinyl Wallcovering
  - RHIS Rigid High Impact Sheet
  - WSSP Wetwall Solid Surface Panel
  - WVV Wetroom Vinyl Wallcovering
- FLOOR FINISHES LEGEND:**
- CFS Concrete Floor Sealer
  - EFC Epoxy Floor Coating
  - PFC Polyurethane Floor Coating
  - RAF Rubber Athletic Flooring
  - RSF Rubber Sheet Flooring
  - SCF Seamless Cushioned Flooring
  - SDRF Static-Dissipative Rubber Sheet Flooring
  - SDVF Static-Dissipative Vinyl Sheet Flooring
  - VSF Vinyl Sheet Flooring
  - WSVF Wetroom Safety Vinyl Sheet Flooring
- FLOOR BASE LEGEND:**
- FCB Flash Cove Base
  - RB Rubber Base
  - SCF Seamless Cushioned Flooring

**DOORS**

Types:

Type:Qty:	Size (mm):	Material:	Finish:	Side Lt:	Blinds:	Protect.:	Privacy Film:	Function:	Card Reader:	Mag Lock:	Auto Opener:	Hold Open:	Hinges:	Accessory 1:	Accessory 2:	Accessory 3:	Closer:
								Storeroom	<input checked="" type="checkbox"/>	<input type="checkbox"/>	<input type="checkbox"/>	<input type="checkbox"/>	Butt Hinge				Surface

Door Remarks:  Security Grille  Anti-barricade strategy

**MILLWORK AND SPECIALTY CASEWORK**

Storage Requirements:

**UPPER UNITS** (U1-U8) **SHELF** (S1)

**LOWER UNITS** (L1-L12) **RECEPTION/TRANSACTION COUNTER / CARE TEAM STATION DESK** (TC1, TC2) **UTILITY SINK AND COUNTER UNIT** (UC1)

**FULL-HEIGHT CABINETS** (C1-C5)

**Legend:**

Category	Min. Length (mm)	Motorized Adjustable Height	Standing Height	Specialty Casework
3	4500	<input type="checkbox"/>	<input type="checkbox"/>	<input type="checkbox"/>

**FINISHES**

Full-height Cabinet:

Upper Millwork:

Countertop:

Lower Millwork:

Shelf:

Remarks:

**MECHANICAL REQUIREMENTS**

**PLUMBING**

(Quantity) Hygiene Sink:  Lavatory:  Kitchen Sink:  Seamless Kitchen Sink:  Utility / Process Sink:  Scrub Sink:  Floor Sink:

Plumbing Remarks:

**Other Fixtures:**

- Shower  Eyewash Station
- Tub  Eyewash/Shower Station
- Ice Maker  Emergency Shower
- Water Closet  Flush Rim Sink
- Instantaneous Hot Water  Floor Drain
- Water Bottle Refill Station

Other:

**MED / NON-MED GASES**

(Quantity) Oxygen:  Medical Air:  Medical Vacuum:  Nitrous Oxide:  CO2:  AGSS:  Nitrogen:  Laboratory Air:  Laboratory Vacuum:  Utility Compressed Air:

Gas Remarks:



# Appendix 1B Minimum Room Requirements

Room Name:

Program Number(s):	1. T2.04	7.	13.	19.	25.	31.	37.	43.
	2.	8.	14.	20.	26.	32.	38.	44.
	3.	9.	15.	21.	27.	33.	39.	45.
	4.	10.	16.	22.	28.	34.	40.	46.
	5.	11.	17.	23.	29.	35.	41.	47.
	6.	12.	18.	24.	30.	36.	42.	48.

## ARCHITECTURAL REQUIREMENTS

<b>WALL AND CEILING</b> Wall Material: <input type="text" value="ARGB 1.2m AFF, GB above"/> Finish: <input type="text" value="PT"/> Ceiling Material: <input type="text" value="ACT"/> Finish: <input type="text" value="PF"/>	<b>WALL PROTECTION</b> Type: <input type="text" value="FRL"/> <input checked="" type="checkbox"/> Corner Guards <input type="checkbox"/> Hand Rails <input type="checkbox"/> Bed Bumper / Locator Height: <input type="text" value="1350 mm"/> <input type="checkbox"/> Crash Rails <input checked="" type="checkbox"/> Chair Rail	<b>GLAZING</b> <input checked="" type="checkbox"/> Interior Glazing	<b>FLOORING TYPES</b> Material: <input type="text" value="VSF"/> Base: <input type="text" value="FCB"/>	<b>ROOM ACCESSORIES</b> <input checked="" type="checkbox"/> Coat Hooks <input type="checkbox"/> Ceiling Lift <input type="checkbox"/> Magnetic Whiteboard <input checked="" type="checkbox"/> Mirror <input type="checkbox"/> Infant Change Table <input type="checkbox"/> Privacy Curtain
--	--	--	--	--

- LEGEND:**
- WALL AND CEILING LEGEND:**
- AC Architectural Ceiling
  - ACT Acoustic Ceiling Tile
  - ACT-C Cleanroom
  - ARGB Abuse-Resistant Gypsum Board
  - GB Gypsum Board
  - IRGB Impact-Resistant Gypsum Board
  - KLCT Kitchen Lay-in Ceiling Tile
  - MMRGB Moisture and Mould-Resistant Gypsum Board
  - SACT Security Acoustic Ceiling Tile
- WALL FINISHES LEGEND:**
- EWC Epoxy Wall Coating
  - HPC High Performance Coating
  - PT Paint
- CEILING FINISHES LEGEND:**
- ECC Epoxy Ceiling Coating
  - HPC High Performance Coating
  - PF Prefinished
  - PT Paint
- WALL PROTECTION LEGEND:**
- ESRP Extruded Semi-Rigid PVCu Panel
  - FRL Fibre Reinforced Laminate
  - FRP Fibreglass Reinforced Plastic
  - PVV Protective Vinyl Wallcovering
  - RHIS Rigid High Impact Sheet
  - WSSP Wetwall Solid Surface Panel
  - WVV Wetroom Vinyl Wallcovering
- FLOOR FINISHES LEGEND:**
- CFS Concrete Floor Sealer
  - EFC Epoxy Floor Coating
  - PFC Polyurethane Floor Coating
  - RAF Rubber Athletic Flooring
  - RSF Rubber Sheet Flooring
  - SCF Seamless Cushioned Flooring
  - SDRF Static-Dissipative Rubber Sheet Flooring
  - SDVF Static-Dissipative Vinyl Sheet Flooring
  - VSF Vinyl Sheet Flooring
  - WSVF Wetroom Safety Vinyl Sheet Flooring
- FLOOR BASE LEGEND:**
- FCB Flash Cove Base
  - RB Rubber Base
  - SCF Seamless Cushioned Flooring

**DOORS**

Types:

Type	Qty	Size (mm)	Material	Finish	Side Lt.	Blinds	Protect.	Privacy Film	Function	Card Reader	Mag Lock	Auto Opener	Hold Open	Hinges	Accessory 1	Accessory 2	Accessory 3	Closer
D2	1	1830 x 2135	Solid Core	FRL	<input type="checkbox"/>	<input type="checkbox"/>	1 Low	<input checked="" type="checkbox"/>	Passage	<input type="checkbox"/>	<input type="checkbox"/>	<input type="checkbox"/>	<input type="checkbox"/>	Butt Hinge	Astragal	Flush Bolt		Concealed

Door Remarks:  Door to be lockable with key

Security Grille  
 Anti-barricade strategy

**MILLWORK AND SPECIALTY CASEWORK**

Storage Requirements:

**UPPER UNITS**

- U1
- U2
- U3
- U4
- U5
- U6
- U7
- U8

**LOWER UNITS**

- L1
- L2
- L3
- L4
- L5
- L6
- L7
- L8
- L9
- L10
- L11
- L12

**RECEPTION/TRANSACTION COUNTER / CARE TEAM STATION DESK**

- TC1
- TC2

**UTILITY SINK AND COUNTER UNIT**

- UC1

**SHELF**

- S1

**FULL-HEIGHT CABINETS**

- C1
- C2
- C3
- C4
- C5

**Legend:**

Category	Min. Length (mm)	Motorized Adjustable Height	Standing Height	Specialty Casework
Category 0 - None				
Category 1 - Low (1% - 4%)				
Category 2 - Med (5% - 9%)				
Category 3 - High (10% or Greater)				

**FINISHES**

- Full-height Cabinet:
- Upper Millwork:
- Countertop:
- Lower Millwork:
- Shelf:

Remarks:

## MECHANICAL REQUIREMENTS

**PLUMBING**

Hand Hygiene Sink:	Laundry:	Kitchen Sink:	Seamless Kitchen Sink:	Utility / Process Sink:	Scrub Sink:	Floor Sink:
1						

Plumbing Remarks:

**Other Fixtures:**

- Shower
- Tub
- Ice Maker
- Water Closet
- Instantaneous Hot Water
- Eyewash Station
- Eyewash/Shower Station
- Emergency Shower
- Flush Rim Sink
- Floor Drain
- Water Bottle Refill Station

Other:

**MED / NON-MED GASES**

Oxygen:	Medical Air:	Medical Vacuum:	Nitrous Oxide:	CO2:	AGSS:	Nitrogen:	Laboratory Air:	Laboratory Vacuum:	Utility Compressed Air:

Gas Remarks:

**Appendix 1B Minimum Room Requirements**

Room Name:

Program Number(s):

1. T1.08	7.	13.	19.	25.	31.	37.	43.
2.	8.	14.	20.	26.	32.	38.	44.
3.	9.	15.	21.	27.	33.	39.	45.
4.	10.	16.	22.	28.	34.	40.	46.
5.	11.	17.	23.	29.	35.	41.	47.
6.	12.	18.	24.	30.	36.	42.	48.

**ARCHITECTURAL REQUIREMENTS**

<b>WALL AND CEILING</b> Wall Material: <input type="text" value="GB"/> Finish: <input type="text" value="PT"/> Ceiling Material: <input type="text" value="ACT"/> Finish: <input type="text" value="PF"/>	<b>WALL PROTECTION</b> Type: <input type="text"/> Height: <input type="text"/> <input checked="" type="checkbox"/> Corner Guards <input type="checkbox"/> Hand Rails <input type="checkbox"/> Bed Bumper / Locator <input type="checkbox"/> Crash Rails <input checked="" type="checkbox"/> Chair Rail	<b>GLAZING</b> <input checked="" type="checkbox"/> Interior Glazing	<b>FLOORING TYPES</b> Material: <input type="text" value="VSF"/> Base: <input type="text" value="FCB"/>	<b>ROOM ACCESSORIES</b> <input checked="" type="checkbox"/> Coat Hooks <input type="checkbox"/> Ceiling Lift <input checked="" type="checkbox"/> Magnetic Whiteboard <input type="checkbox"/> Mirror <input type="checkbox"/> Infant Change Table <input type="checkbox"/> Privacy Curtain
---	---	--	--	--

- LEGEND:**
- WALL AND CEILING LEGEND:**
- AC Architectural Ceiling
  - ACT Acoustic Ceiling Tile
  - ACT-C Cleanroom
  - ARGB Abuse-Resistant Gypsum Board
  - GB Gypsum Board
  - IRGB Impact-Resistant Gypsum Board
  - KLCT Kitchen Lay-in Ceiling Tile
  - MMRGB Moisture and Mould-Resistant Gypsum Board
  - SACT Security Acoustic Ceiling Tile
- WALL FINISHES LEGEND:**
- EWC Epoxy Wall Coating
  - HPC High Performance Coating
  - PT Paint
- CEILING FINISHES LEGEND:**
- ECC Epoxy Ceiling Coating
  - HPC High Performance Coating
  - PF Prefinished
  - PT Paint
- WALL PROTECTION LEGEND:**
- ESRP Extruded Semi-Rigid PVCu Panel
  - FRL Fibre Reinforced Laminate
  - FRP Fibreglass Reinforced Plastic
  - PVV Protective Vinyl Wallcovering
  - RHIS Rigid High Impact Sheet
  - WSSP Wetwall Solid Surface Panel
  - WVV Wetroom Vinyl Wallcovering
- FLOOR FINISHES LEGEND:**
- CFS Concrete Floor Sealer
  - EFC Epoxy Floor Coating
  - PFC Polyurethane Floor Coating
  - RAF Rubber Athletic Flooring
  - RSF Rubber Sheet Flooring
  - SCF Seamless Cushioned Flooring
  - SDRF Static-Dissipative Rubber Sheet Flooring
  - SDVF Static-Dissipative Vinyl Sheet Flooring
  - VSF Vinyl Sheet Flooring
  - WSVF Wetroom Safety Vinyl Sheet Flooring
- FLOOR BASE LEGEND:**
- FCB Flash Cove Base
  - RB Rubber Base
  - SCF Seamless Cushioned Flooring

**DOORS**

Types:

Type	Qty	Size (mm)	Material	Finish	Side Lt.	Blinds	Protect.	Privacy Film	Function	Card Reader	Mag Lock	Auto Opener	Hold Open	Hinges	Accessory 1	Accessory 2	Accessory 3	Closer
C	1	915 x 2135	Solid Core	FRL			1 Low	<input checked="" type="checkbox"/>	Storeroom	<input checked="" type="checkbox"/>	<input type="checkbox"/>	<input type="checkbox"/>	<input type="checkbox"/>	Butt Hinge				Surface

Door Remarks:  Security Grille  Anti-barricade strategy

**MILLWORK AND SPECIALTY CASEWORK**

Storage Requirements: Provide (12) three tiered locker

**UPPER UNITS:** U1, U2, U3, U4, U5, U6, U7, U8

**LOWER UNITS:** L1, L2, L3, L4, L5, L6, L7, L8, L9, L10, L11, L12

**RECEPTION/TRANSACTION COUNTER / CARE TEAM STATION DESK:** TC1, TC2

**UTILITY SINK AND COUNTER UNIT:** UC1

**FINISHES**

Full-height Cabinet:   
 Upper Millwork:   
 Countertop:   
 Lower Millwork:   
 Shelf:

Remarks: Provide one (1) Change Cubicle

Category	Min. Length (mm)	Motorized Adjustable Height	Standing Height	Specialty Casework
2	2100	<input type="checkbox"/>	<input checked="" type="checkbox"/>	<input type="checkbox"/>

**MECHANICAL REQUIREMENTS**

<b>PLUMBING</b> (Quantity) Hand Hygiene Sink: <input type="text" value="1"/> Lavatory: <input type="text"/> Kitchen Sink: <input type="text" value="1"/> Kitchen Sink: <input type="text"/> Utility / Process Sink: <input type="text"/> Scrub Sink: <input type="text"/> Floor Sink: <input type="text"/> Plumbing Remarks: <input type="text"/>	Other Fixtures: <input type="checkbox"/> Shower <input type="checkbox"/> Tub <input type="checkbox"/> Ice Maker <input type="checkbox"/> Water Closet <input type="checkbox"/> Instantaneous Hot Water <input type="checkbox"/> Ewwash Station <input type="checkbox"/> Eyewash/Shower Station <input type="checkbox"/> Emergency Shower <input type="checkbox"/> Flush Rim Sink <input type="checkbox"/> Floor Drain <input type="checkbox"/> Water Bottle Refill Station Other: <input type="text"/>	<b>MED / NON-MED GASES</b> (Quantity) Oxygen: <input type="text"/> Medical Air: <input type="text"/> Medical Vacuum: <input type="text"/> Nitrous Oxide: <input type="text"/> CO2: <input type="text"/> AGSS: <input type="text"/> Nitrogen: <input type="text"/> Laboratory Air: <input type="text"/> Laboratory Vacuum: <input type="text"/> Utility Compressed Air: <input type="text"/> Gas Remarks: <input type="text"/>
--	---	---

**Appendix 1B Minimum Room Requirements**

Room Name:

Program Number(s):

1.	T2.06	7.		13.		19.		25.		31.		37.		43.
2.		8.		14.		20.		26.		32.		38.		44.
3.		9.		15.		21.		27.		33.		39.		45.
4.		10.		16.		22.		28.		34.		40.		46.
5.		11.		17.		23.		29.		35.		41.		47.
6.		12.		18.		24.		30.		36.		42.		48.

**ARCHITECTURAL REQUIREMENTS**

<b>WALL AND CEILING</b> Wall Material: <input type="text" value="GB"/> Finish: <input type="text" value="PT"/> Ceiling Material: <input type="text" value="ACT"/> Finish: <input type="text" value="PF"/>		<b>WALL PROTECTION</b> Type: <input type="text"/> Height: <input type="text"/> <input checked="" type="checkbox"/> Corner Guards <input type="checkbox"/> Hand Rails <input type="checkbox"/> Bed Bumper / Locator <input type="checkbox"/> Crash Rails <input type="checkbox"/> Chair Rail			<b>GLAZING</b> <input type="checkbox"/> Interior Glazing		<b>FLOORING TYPES</b> Material: <input type="text" value="VSF"/> Base: <input type="text" value="FCB"/>		<b>ROOM ACCESSORIES</b> <input type="checkbox"/> Coat Hooks <input type="checkbox"/> Ceiling Lift <input checked="" type="checkbox"/> Magnetic Whiteboard <input type="checkbox"/> Mirror <input type="checkbox"/> Infant Change Table <input type="checkbox"/> Privacy Curtain		
---	--	--	--	--	---	--	--	--	---	--	--

- LEGEND:**
- WALL AND CEILING LEGEND:**
- AC Architectural Ceiling
  - ACT Acoustic Ceiling Tile
  - ACT-C Cleanroom
  - ARGB Abuse-Resistant Gypsum Board
  - GB Gypsum Board
  - IRGB Impact-Resistant Gypsum Board
  - KLCT Kitchen Lay-in Ceiling Tile
  - MMRGB Moisture and Mould-Resistant Gypsum Board
  - SACT Security Acoustic Ceiling Tile
- WALL FINISHES LEGEND:**
- EWC Epoxy Wall Coating
  - HPC High Performance Coating
  - PT Paint
- CEILING FINISHES LEGEND:**
- ECC Epoxy Ceiling Coating
  - HPC High Performance Coating
  - PF Prefinished
  - PT Paint
- WALL PROTECTION LEGEND:**
- ESRP Extruded Semi-Rigid PVCu Panel
  - FRL Fibre Reinforced Laminate
  - FRP Fibreglass Reinforced Plastic
  - PVV Protective Vinyl Wallcovering
  - RHIS Rigid High Impact Sheet
  - WSSP Wetwall Solid Surface Panel
  - WVV Wetroom Vinyl Wallcovering
- FLOOR FINISHES LEGEND:**
- CFS Concrete Floor Sealer
  - EFC Epoxy Floor Coating
  - PFC Polyurethane Floor Coating
  - RAF Rubber Athletic Flooring
  - RSF Rubber Sheet Flooring
  - SCF Seamless Cushioned Flooring
  - SDRF Static-Dissipative Rubber Sheet Flooring
  - SDVF Static-Dissipative Vinyl Sheet Flooring
  - VSF Vinyl Sheet Flooring
  - WSVF Wetroom Safety Vinyl Sheet Flooring
- FLOOR BASE LEGEND:**
- FCB Flash Cove Base
  - RB Rubber Base
  - SCF Seamless Cushioned Flooring

**DOORS**

Types:

Type	Qty	Size (mm)	Material	Finish	Side Lt.	Blinds	Protect.	Privacy Film	Function	Card Reader	Mag Lock	Auto Opener	Hold Open	Hinges	Accessory 1	Accessory 2	Accessory 3	Closer
A	1	915 x 2135	Solid Core	FRL	<input checked="" type="checkbox"/>	<input type="checkbox"/>	2 High	<input type="checkbox"/>	Storeroom	<input checked="" type="checkbox"/>	<input type="checkbox"/>	<input type="checkbox"/>	<input checked="" type="checkbox"/>	Butt Hinge				Surface

Door Remarks:

Security Grille  
 Anti-barricade strategy

**MILLWORK AND SPECIALTY CASEWORK**

**UPPER UNITS** (U1-U8)

**LOWER UNITS** (L1-L12)

**RECEPTION/TRANSACTION COUNTER / CARE TEAM STATION DESK** (TC1, TC2)

**UTILITY SINK AND COUNTER UNIT** (UC1)

**Storage Requirements:**

**FINISHES**

Full-height Cabinet:

Upper Millwork:

Countertop:

Lower Millwork:

Shelf:

Remarks:

Category	Min. Length (mm)	Motorized Adjustable Height	Standing Height	Specialty Casework
3	13500	<input checked="" type="checkbox"/>	<input checked="" type="checkbox"/>	<input type="checkbox"/>

**MECHANICAL REQUIREMENTS**

<b>PLUMBING</b> (Quantity) Hand Hygiene Sink: <input type="text"/> Lavatory: <input type="text"/> Kitchen Sink: <input type="text"/> Seamless Kitchen Sink: <input type="text"/> Utility / Process Sink: <input type="text"/> Scrub Sink: <input type="text"/> Floor Sink: <input type="text"/>							Other Fixtures: <input type="checkbox"/> Shower <input type="checkbox"/> Eyewash Station <input type="checkbox"/> Tub <input type="checkbox"/> Eyewash/Shower Station <input type="checkbox"/> Ice Maker <input type="checkbox"/> Emergency Shower <input type="checkbox"/> Water Closet <input type="checkbox"/> Flush Rim Sink <input type="checkbox"/> Instantaneous Hot Water <input type="checkbox"/> Floor Drain <input type="checkbox"/> Water Bottle Refill Station Other: <input type="text"/>				<b>MED / NON-MED GASES</b> (Quantity) Oxygen: <input type="text"/> Medical Air: <input type="text"/> Medical Vacuum: <input type="text"/> Nitrous Oxide: <input type="text"/> CO2: <input type="text"/> AGSS: <input type="text"/> Nitrogen: <input type="text"/> Laboratory Air: <input type="text"/> Laboratory Vacuum: <input type="text"/> Utility Compressed Air: <input type="text"/>				
Plumbing Remarks: <input type="text"/>							Gas Remarks: <input type="text"/>								



**Appendix 1B Minimum Room Requirements**

Room Name:

Program Number(s):

1.	T2.05	7.		13.		19.		25.		31.		37.		43.
2.		8.		14.		20.		26.		32.		38.		44.
3.		9.		15.		21.		27.		33.		39.		45.
4.		10.		16.		22.		28.		34.		40.		46.
5.		11.		17.		23.		29.		35.		41.		47.
6.		12.		18.		24.		30.		36.		42.		48.

**ARCHITECTURAL REQUIREMENTS**

<b>WALL AND CEILING</b> Wall Material: <input type="text" value="GB"/> Finish: <input type="text" value="PT"/> Ceiling Material: <input type="text" value="ACT"/> Finish: <input type="text" value="PF"/>		<b>WALL PROTECTION</b> Type: <input type="text"/> Height: <input type="text"/> <input checked="" type="checkbox"/> Corner Guards <input type="checkbox"/> Hand Rails <input type="checkbox"/> Bed Bumper / Locator <input type="checkbox"/> Crash Rails <input checked="" type="checkbox"/> Chair Rail			<b>GLAZING</b> <input checked="" type="checkbox"/> Interior Glazing		<b>FLOORING TYPES</b> Material: <input type="text" value="VSF"/> Base: <input type="text" value="RB"/>		<b>ROOM ACCESSORIES</b> <input checked="" type="checkbox"/> Coat Hooks <input type="checkbox"/> Ceiling Lift <input checked="" type="checkbox"/> Magnetic Whiteboard <input type="checkbox"/> Mirror <input type="checkbox"/> Infant Change Table <input type="checkbox"/> Privacy Curtain		
---	--	---	--	--	--	--	---	--	--	--	--

- LEGEND:**
- WALL AND CEILING LEGEND:**
- AC Architectural Ceiling
  - ACT Acoustic Ceiling Tile
  - ACT-C Cleanroom
  - ARGB Abuse-Resistant Gypsum Board
  - GB Gypsum Board
  - IRGB Impact-Resistant Gypsum Board
  - KLCT Kitchen Lay-in Ceiling Tile
  - MMRGB Moisture and Mould-Resistant Gypsum Board
  - SACT Security Acoustic Ceiling Tile
- WALL FINISHES LEGEND:**
- EWC Epoxy Wall Coating
  - HPC High Performance Coating
  - PT Paint
- CEILING FINISHES LEGEND:**
- ECC Epoxy Ceiling Coating
  - HPC High Performance Coating
  - PF Prefinished
  - PT Paint
- WALL PROTECTION LEGEND:**
- ESRP Extruded Semi-Rigid PVCu Panel
  - FRL Fibre Reinforced Laminata
  - FRP Fibreglass Reinforced Plastic
  - PVV Protective Vinyl Wallcovering
  - RHIS Rigid High Impact Sheet
  - WSSP Wetwall Solid Surface Panel
  - WVV Wetroom Vinyl Wallcovering
- FLOOR FINISHES LEGEND:**
- CFS Concrete Floor Sealer
  - EFC Epoxy Floor Coating
  - PFC Polyurethane Floor Coating
  - RAF Rubber Athletic Flooring
  - RSF Rubber Sheet Flooring
  - SCF Seamless Cushioned Flooring
  - SDRF Static-Dissipative Rubber Sheet Flooring
  - SDVF Static-Dissipative Vinyl Sheet Flooring
  - VSF Vinyl Sheet Flooring
  - WSVF Wetroom Safety Vinyl Sheet Flooring
- FLOOR BASE LEGEND:**
- FCB Flash Cove Base
  - RB Rubber Base
  - SCF Seamless Cushioned Flooring

**DOORS**

Types:

Type	Qty	Size (mm)	Material	Finish	Side Lt.	Blinds	Protect.	Privacy Film	Function	Card Reader	Mag Lock	Auto Opener	Hold Open	Hinges	Accessory 1	Accessory 2	Accessory 3	Closer
D	1	1065 x 2135	Solid Core	FRL	<input type="checkbox"/>	<input type="checkbox"/>	1 Low	<input checked="" type="checkbox"/>	Storeroom	<input checked="" type="checkbox"/>	<input type="checkbox"/>	<input type="checkbox"/>	<input type="checkbox"/>	Butt Hinge	Astragal	Flush Bolt		Surface

Door Remarks:

Security Grille  
 Anti-barricade strategy

**MILLWORK AND SPECIALTY CASEWORK**

**UPPER UNITS** (U1-U8) **LOWER UNITS** (L1-L12) **RECEPTION/TRANSACTION COUNTER / CARE TEAM STATION DESK** (TC1-TC2) **UTILITY SINK AND COUNTER UNIT** (UC1)

Storage Requirements:

**FINISHES**

Full-height Cabinet:   
 Upper Millwork:   
 Countertop:   
 Lower Millwork:   
 Shelf:

Remarks:

**Legend:**

Category	Min. Length (mm)	Motorized Adjustable Height	Standing Height	Specialty Casework
Category 0 - None		<input type="checkbox"/>	<input type="checkbox"/>	<input type="checkbox"/>
Category 1 - Low (1% - 4%)		<input type="checkbox"/>	<input type="checkbox"/>	<input type="checkbox"/>
Category 2 - Med (5% - 9%)		<input type="checkbox"/>	<input type="checkbox"/>	<input type="checkbox"/>
Category 3 - High (10% or Greater)		<input type="checkbox"/>	<input type="checkbox"/>	<input type="checkbox"/>

**MECHANICAL REQUIREMENTS**

<b>PLUMBING</b> (Quantity) Hand Hygiene Sink: <input type="text"/> Lavatory: <input type="text"/> Kitchen Sink: <input type="text"/> Seamless Kitchen Sink: <input type="text"/> Utility / Process Sink: <input type="text"/> Scrub Sink: <input type="text"/> Floor Sink: <input type="text"/>							Other Fixtures: <input type="checkbox"/> Shower <input type="checkbox"/> Eyewash Station <input type="checkbox"/> Tub <input type="checkbox"/> Eyewash/Shower Station <input type="checkbox"/> Ice Maker <input type="checkbox"/> Emergency Shower <input type="checkbox"/> Water Closet <input type="checkbox"/> Flush Rim Sink <input type="checkbox"/> Instantaneous Hot Water <input type="checkbox"/> Floor Drain <input type="checkbox"/> Water Bottle Refill Station Other <input type="text"/>				<b>MED / NON-MED GASES</b> (Quantity) Oxygen: <input type="text"/> Medical Air: <input type="text"/> Medical Vacuum: <input type="text"/> Nitrous Oxide: <input type="text"/> CO2: <input type="text"/> AGSS: <input type="text"/> Nitrogen: <input type="text"/> Laboratory Air: <input type="text"/> Laboratory Vacuum: <input type="text"/> Utility Compressed Air: <input type="text"/>					
Plumbing Remarks: <input type="text"/>											Gas Remarks: <input type="text"/>					

**Appendix 1B Minimum Room Requirements**

Room Name:

Program Number(s):

1. T1.04	7.	13.	19.	25.	31.	37.	43.
2.	8.	14.	20.	26.	32.	38.	44.
3.	9.	15.	21.	27.	33.	39.	45.
4.	10.	16.	22.	28.	34.	40.	46.
5.	11.	17.	23.	29.	35.	41.	47.
6.	12.	18.	24.	30.	36.	42.	48.

**ARCHITECTURAL REQUIREMENTS**

<b>WALL AND CEILING</b> Wall Material: <input type="text" value="GB"/> Finish: <input type="text" value="PT"/> Ceiling Material: <input type="text" value="ACT"/> Finish: <input type="text" value="PF"/>	<b>WALL PROTECTION</b> Type: <input type="text"/> Height: <input type="text"/> <input checked="" type="checkbox"/> Corner Guards <input type="checkbox"/> Hand Rails <input type="checkbox"/> Bed Bumper / Locator <input type="checkbox"/> Crash Rails <input checked="" type="checkbox"/> Chair Rail	<b>GLAZING</b> <input checked="" type="checkbox"/> Interior Glazing	<b>FLOORING TYPES</b> Material: <input type="text" value="VSF"/> Base: <input type="text" value="RB"/>	<b>ROOM ACCESSORIES</b> <input checked="" type="checkbox"/> Coat Hooks <input type="checkbox"/> Ceiling Lift <input checked="" type="checkbox"/> Magnetic Whiteboard <input type="checkbox"/> Mirror <input type="checkbox"/> Infant Change Table <input type="checkbox"/> Privacy Curtain
---	---	--	---	--

- LEGEND:**
- WALL AND CEILING LEGEND:**
- AC Architectural Ceiling
  - ACT Acoustic Ceiling Tile
  - ACT-C Cleanroom
  - ARGB Abuse-Resistant Gypsum Board
  - GB Gypsum Board
  - IRGB Impact-Resistant Gypsum Board
  - KLCT Kitchen Lay-in Ceiling Tile
  - MMRGB Moisture and Mould-Resistant Gypsum Board
  - SACT Security Acoustic Ceiling Tile
- WALL FINISHES LEGEND:**
- EWC Epoxy Wall Coating
  - HPC High Performance Coating
  - PT Paint
- CEILING FINISHES LEGEND:**
- ECC Epoxy Ceiling Coating
  - HPC High Performance Coating
  - PF Prefinished
  - PT Paint
- WALL PROTECTION LEGEND:**
- ESRP Extruded Semi-Rigid PVCu Panel
  - FRL Fibre Reinforced Laminate
  - FRP Fibreglass Reinforced Plastic
  - PVV Protective Vinyl Wallcovering
  - RHIS Rigid High Impact Sheet
  - WSSP Wetwall Solid Surface Panel
  - WVV Wetroom Vinyl Wallcovering
- FLOOR FINISHES LEGEND:**
- CFS Concrete Floor Sealer
  - EFC Epoxy Floor Coating
  - PFC Polyurethane Floor Coating
  - RAF Rubber Athletic Flooring
  - RSF Rubber Sheet Flooring
  - SCF Seamless Cushioned Flooring
  - SDRF Static-Dissipative Rubber Sheet Flooring
  - SDVF Static-Dissipative Vinyl Sheet Flooring
  - VSF Vinyl Sheet Flooring
  - WSVF Wetroom Safety Vinyl Sheet Flooring
- FLOOR BASE LEGEND:**
- FCB Flash Cove Base
  - RB Rubber Base
  - SCF Seamless Cushioned Flooring

**DOORS**

Types:

Type	Qty	Size (mm)	Material	Finish	Side Lt.	Blinds	Protect.	Privacy Film	Function	Card Reader	Mag Lock	Auto Opener	Hold Open	Hinges	Accessory 1	Accessory 2	Accessory 3	Closer
D	1	1065 x 2135	Solid Core	FRL	<input type="checkbox"/>	<input type="checkbox"/>	1 Low	<input checked="" type="checkbox"/>	Storeroom	<input checked="" type="checkbox"/>	<input type="checkbox"/>	<input type="checkbox"/>	<input type="checkbox"/>	Butt Hinge	Astragal	Flush Bolt		Surface

Door Remarks:

Security Grille  
 Anti-barricade strategy



**MECHANICAL REQUIREMENTS**

<b>PLUMBING</b> (Quantity) Hand Hygiene Sink: <input type="text"/> Lavatory: <input type="text"/> Kitchen Sink: <input type="text"/> Seamless Kitchen Sink: <input type="text"/> Utility / Process Sink: <input type="text"/> Scrub Sink: <input type="text"/> Floor Sink: <input type="text"/> Plumbing Remarks: <input type="text"/>	Other Fixtures: <input type="checkbox"/> Shower <input type="checkbox"/> Tub <input type="checkbox"/> Ice Maker <input type="checkbox"/> Water Closet <input type="checkbox"/> Instantaneous Hot Water <input type="checkbox"/> Eyewash Station <input type="checkbox"/> Eyewash/Shower Station <input type="checkbox"/> Emergency Shower <input type="checkbox"/> Flush Rim Sink <input type="checkbox"/> Floor Drain <input type="checkbox"/> Water Bottle Refill Station Other: <input type="text"/>	<b>MED / NON-MED GASES</b> (Quantity) Oxygen: <input type="text"/> Medical Air: <input type="text"/> Medical Vacuum: <input type="text"/> Nitrous Oxide: <input type="text"/> CO2: <input type="text"/> AGSS: <input type="text"/> Nitrogen: <input type="text"/> Laboratory Air: <input type="text"/> Laboratory Vacuum: <input type="text"/> Utility Compressed Air: <input type="text"/> Gas Remarks: <input type="text"/>
---	---	---

**Appendix 1B Minimum Room Requirements**

Room Name:

Program Number(s):

1.	T1.07	7.		13.		19.		25.		31.		37.		43.
2.		8.		14.		20.		26.		32.		38.		44.
3.		9.		15.		21.		27.		33.		39.		45.
4.		10.		16.		22.		28.		34.		40.		46.
5.		11.		17.		23.		29.		35.		41.		47.
6.		12.		18.		24.		30.		36.		42.		48.

**ARCHITECTURAL REQUIREMENTS**

<b>WALL AND CEILING</b> Wall Material: <input type="text" value="GB"/> Finish: <input type="text" value="PT"/> Ceiling Material: <input type="text" value="ACT"/> Finish: <input type="text" value="PF"/>		<b>WALL PROTECTION</b> Type: <input type="text"/> Height: <input type="text"/> <input checked="" type="checkbox"/> Corner Guards <input type="checkbox"/> Hand Rails <input type="checkbox"/> Bed Bumper / Locator <input type="checkbox"/> Crash Rails <input checked="" type="checkbox"/> Chair Rail			<b>GLAZING</b> <input checked="" type="checkbox"/> Interior Glazing		<b>FLOORING TYPES</b> Material: <input type="text" value="VSF"/> Base: <input type="text" value="RB"/>		<b>ROOM ACCESSORIES</b> <input checked="" type="checkbox"/> Coat Hooks <input type="checkbox"/> Ceiling Lift <input checked="" type="checkbox"/> Magnetic Whiteboard <input type="checkbox"/> Mirror <input type="checkbox"/> Infant Change Table <input type="checkbox"/> Privacy Curtain		
---	--	---	--	--	--	--	---	--	--	--	--

- LEGEND:**
- WALL AND CEILING LEGEND:**
- AC Architectural Ceiling
  - ACT Acoustic Ceiling Tile
  - ACT-C Cleanroom
  - ARGB Abuse-Resistant Gypsum Board
  - GB Gypsum Board
  - IRGB Impact-Resistant Gypsum Board
  - KLCT Kitchen Lay-in Ceiling Tile
  - MMRGB Moisture and Mould-Resistant Gypsum Board
  - SACT Security Acoustic Ceiling Tile
- WALL FINISHES LEGEND:**
- EWC Epoxy Wall Coating
  - HPC High Performance Coating
  - PT Paint
- CEILING FINISHES LEGEND:**
- ECC Epoxy Ceiling Coating
  - HPC High Performance Coating
  - PF Prefinished
  - PT Paint
- WALL PROTECTION LEGEND:**
- ESRP Extruded Semi-Rigid PVCu Panel
  - FRL Fibre Reinforced Laminate
  - FRP Fibreglass Reinforced Plastic
  - PVV Protective Vinyl Wallcovering
  - RHIS Rigid High Impact Sheet
  - WSSP Wetwall Solid Surface Panel
  - WVV Wetroom Vinyl Wallcovering
- FLOOR FINISHES LEGEND:**
- CFS Concrete Floor Sealer
  - EFC Epoxy Floor Coating
  - PFC Polyurethane Floor Coating
  - RAF Rubber Athletic Flooring
  - RSF Rubber Sheet Flooring
  - SCF Seamless Cushioned Flooring
  - SDRF Static-Dissipative Rubber Sheet Flooring
  - SDVF Static-Dissipative Vinyl Sheet Flooring
  - VSF Vinyl Sheet Flooring
  - WSVF Wetroom Safety Vinyl Sheet Flooring
- FLOOR BASE LEGEND:**
- FCB Flash Cove Base
  - RB Rubber Base
  - SCF Seamless Cushioned Flooring

**DOORS**

Types:

Type	Qty	Size (mm)	Material	Finish	Side Lt.	Blinds	Protect.	Privacy Film	Function	Card Reader	Mag Lock	Auto Opener	Hold Open	Hinges	Accessory 1	Accessory 2	Accessory 3	Closer
C	1	915 x 2135	Solid Core	FRL	<input type="checkbox"/>	<input type="checkbox"/>	1 Low	<input checked="" type="checkbox"/>	Storeroom	<input checked="" type="checkbox"/>	<input type="checkbox"/>	<input type="checkbox"/>	<input type="checkbox"/>	Butt Hinge				Surface

Door Remarks:  Security Grille  Anti-barricade strategy

**MILLWORK AND SPECIALTY CASEWORK**

Storage Requirements:

**UPPER UNITS** (U1-U8) **LOWER UNITS** (L1-L9)

**RECEPTION/TRANSACTION COUNTER / CARE TEAM STATION DESK** (TC1, TC2)

**UTILITY SINK AND COUNTER UNIT** (UC1)

**SHELF** (S1)

**FULL-HEIGHT CABINETS** (C1-C5)

**Legend:**

Category	Min. Length (mm)	Motorized Adjustable Height	Standing Height	Specialty Casework
Category 0 - None				
Category 1 - Low (1% - 4%)				
Category 2 - Med (5% - 9%)				
Category 3 - High (10% or Greater)				
2	1800	<input type="checkbox"/>	<input type="checkbox"/>	<input type="checkbox"/>

**FINISHES**

Full-height Cabinet:	Plastic Laminate
Upper Millwork:	Plastic Laminate
Countertop:	
Lower Millwork:	Plastic Laminate
Shelf:	

Remarks:

**MECHANICAL REQUIREMENTS**

<b>PLUMBING</b> (Quantity) Hand Hygiene Sink: <input type="text"/> Lavatory: <input type="text"/> Kitchen Sink: <input type="text"/> Seamless Kitchen Sink: <input type="text"/> Utility / Process Sink: <input type="text"/> Scrub Sink: <input type="text"/> Floor Sink: <input type="text"/>							Other Fixtures: <input type="checkbox"/> Shower <input type="checkbox"/> Tub <input type="checkbox"/> Ice Maker <input type="checkbox"/> Water Closet <input type="checkbox"/> Instantaneous Hot Water <input type="checkbox"/> Eyewash Station <input type="checkbox"/> Eyewash/Shower Station <input type="checkbox"/> Emergency Shower <input type="checkbox"/> Flush Rim Sink <input type="checkbox"/> Floor Drain <input type="checkbox"/> Water Bottle Refill Station Other: <input type="text"/>				<b>MED / NON-MED GASES</b> (Quantity) Oxygen: <input type="text"/> Medical Air: <input type="text"/> Medical Vacuum: <input type="text"/> Nitrous Oxide: <input type="text"/> CO2: <input type="text"/> AGSS: <input type="text"/> Nitrogen: <input type="text"/> Laboratory Air: <input type="text"/> Laboratory Vacuum: <input type="text"/> Utility Compressed Air: <input type="text"/>					
Plumbing Remarks: <input type="text"/>											Gas Remarks: <input type="text"/>					



# Appendix 1B Minimum Room Requirements

Room Name:

Program Number(s):

1. T1.10	7.	13.	19.	25.	31.	37.	43.
2.	8.	14.	20.	26.	32.	38.	44.
3.	9.	15.	21.	27.	33.	39.	45.
4.	10.	16.	22.	28.	34.	40.	46.
5.	11.	17.	23.	29.	35.	41.	47.
6.	12.	18.	24.	30.	36.	42.	48.

## ARCHITECTURAL REQUIREMENTS

<b>WALL AND CEILING</b> Wall Material: <input type="text" value="MMRGB"/> Finish: <input type="text" value="EWC"/> Ceiling Material: <input type="text" value="MMRGB"/> Finish: <input type="text" value="ECC"/>	<b>WALL PROTECTION</b> Type: <input type="text" value="FRP"/> <input checked="" type="checkbox"/> Corner Guards <input type="checkbox"/> Hand Rails <input type="checkbox"/> Bed Bumper / Locator Height: <input type="text" value="1350 mm"/> <input type="checkbox"/> Crash Rails <input type="checkbox"/> Chair Rail	<b>GLAZING</b> <input type="checkbox"/> Interior Glazing	<b>FLOORING TYPES</b> Material: <input type="text" value="WSVF"/> Base: <input type="text" value="FCB"/>	<b>ROOM ACCESSORIES</b> <input checked="" type="checkbox"/> Coat Hooks <input type="checkbox"/> Ceiling Lift <input type="checkbox"/> Magnetic Whiteboard <input checked="" type="checkbox"/> Mirror <input checked="" type="checkbox"/> Infant Change Table <input type="checkbox"/> Privacy Curtain
--	---	---	---	---

- LEGEND:**
- WALL AND CEILING LEGEND:**
- AC Architectural Ceiling
  - ACT Acoustic Ceiling Tile
  - ACT-C Cleanroom
  - ARGB Abuse-Resistant Gypsum Board
  - GB Gypsum Board
  - IRGB Impact-Resistant Gypsum Board
  - KLCT Kitchen Lay-in Ceiling Tile
  - MMRGB Moisture and Mould-Resistant Gypsum Board
  - SACT Security Acoustic Ceiling Tile
- WALL FINISHES LEGEND:**
- EWC Epoxy Wall Coating
  - HPC High Performance Coating
  - PT Paint
- CEILING FINISHES LEGEND:**
- ECC Epoxy Ceiling Coating
  - HPC High Performance Coating
  - PF Prefinished
  - PT Paint
- WALL PROTECTION LEGEND:**
- ESRP Extruded Semi-Rigid PVCu Panel
  - FRL Fibre Reinforced Laminate
  - FRP Fibreglass Reinforced Plastic
  - PVV Protective Vinyl Wallcovering
  - RHIS Rigid High Impact Sheet
  - WSSP Wetwall Solid Surface Panel
  - WVV Wetroom Vinyl Wallcovering
- FLOOR FINISHES LEGEND:**
- CFS Concrete Floor Sealer
  - EFC Epoxy Floor Coating
  - PFC Polyurethane Floor Coating
  - RAF Rubber Athletic Flooring
  - RSF Rubber Sheet Flooring
  - SCF Seamless Cushioned Flooring
  - SDRF Static-Dissipative Rubber Sheet Flooring
  - SDVF Static-Dissipative Vinyl Sheet Flooring
  - VSF Vinyl Sheet Flooring
  - WSVF Wetroom Safety Vinyl Sheet Flooring
- FLOOR BASE LEGEND:**
- FCB Flash Cove Base
  - RB Rubber Base
  - SCF Seamless Cushioned Flooring

**DOORS**

Types:

Type	Qty	Size (mm)	Material	Finish	Side Lt.	Blinds	Protect.	Privacy Film	Function	Card Reader	Mag Lock	Auto Opener	Hold Open	Hinges	Accessory 1	Accessory 2	Accessory 3	Closer
A	1	1650 x 2135	Solid Core	FRL	<input type="checkbox"/>	<input type="checkbox"/>	2 High	<input type="checkbox"/>	Privacy	<input type="checkbox"/>	<input type="checkbox"/>	<input checked="" type="checkbox"/>	<input type="checkbox"/>	Cont. Double-Acting	Safety Stop	Elec. Strike		Surface

Door Remarks:  Security Grille  Anti-barricade strategy

**MILLWORK AND SPECIALTY CASEWORK**

**UPPER UNITS** (U1-U8) **LOWER UNITS** (L1-L9)

**RECEPTION/TRANSACTION COUNTER / CARE TEAM STATION DESK** (TC1, TC2)

**UTILITY SINK AND COUNTER UNIT** (UC1)

**Storage Requirements:**  SHELF S1

**FINISHES**

- Full-height Cabinet:
- Upper Millwork:
- Countertop:
- Lower Millwork:
- Shelf:

Remarks: Long edge of adult changing table to be located against the wall

## MECHANICAL REQUIREMENTS

**PLUMBING**

Hand Hygiene Sink:	Lavatory:	Kitchen Sink:	Seamless Kitchen Sink:	Utility / Process Sink:	Scrub Sink:	Floor Sink:
	1					

Other Fixtures:  Shower  Tub  Ice Maker  Water Closet  Instantaneous Hot Water

Eyewash Station  Eyewash/Shower Station  Emergency Shower  Flush Rim Sink  Floor Drain  Water Bottle Refill Station

Other:

**MED / NON-MED GASES**

Oxygen:	Medical Air:	Medical Vacuum:	Nitrous Oxide:	CO2:	AGSS:	Nitrogen:	Laboratory Air:	Laboratory Vacuum:	Utility Compressed Air:

Gas Remarks:

**Appendix 1B Minimum Room Requirements**

Room Name:

Program Number(s):

1. T2.01.01	7.	13.	19.	25.	31.	37.	43.
2.	8.	14.	20.	26.	32.	38.	44.
3.	9.	15.	21.	27.	33.	39.	45.
4.	10.	16.	22.	28.	34.	40.	46.
5.	11.	17.	23.	29.	35.	41.	47.
6.	12.	18.	24.	30.	36.	42.	48.

**ARCHITECTURAL REQUIREMENTS**

<b>WALL AND CEILING</b> Wall Material: <input type="text" value="ARGB 1.2m AFF, GB above"/> Finish: <input type="text" value="PT"/> Ceiling Material: <input type="text" value="ACT"/> Finish: <input type="text" value="PF"/>	<b>WALL PROTECTION</b> Type: <input type="text"/> Height: <input type="text"/> <input type="checkbox"/> Corner Guards <input type="checkbox"/> Hand Rails <input type="checkbox"/> Bed Bumper / Locator <input type="checkbox"/> Crash Rails <input checked="" type="checkbox"/> Chair Rail	<b>GLAZING</b> <input checked="" type="checkbox"/> Interior Glazing	<b>FLOORING TYPES</b> Material: <input type="text" value="VSF"/> Base: <input type="text" value="FCB"/>	<b>ROOM ACCESSORIES</b> <input checked="" type="checkbox"/> Coat Hooks <input type="checkbox"/> Ceiling Lift <input type="checkbox"/> Magnetic Whiteboard <input type="checkbox"/> Mirror <input type="checkbox"/> Infant Change Table <input type="checkbox"/> Privacy Curtain
--	--	--	--	---

- LEGEND:**
- WALL AND CEILING LEGEND:**
- AC Architectural Ceiling
  - ACT Acoustic Ceiling Tile
  - ACT-C Cleanroom
  - ARGB Abuse-Resistant Gypsum Board
  - GB Gypsum Board
  - IRGB Impact-Resistant Gypsum Board
  - KLCT Kitchen Lay-in Ceiling Tile
  - MMRGB Moisture and Mould-Resistant Gypsum Board
  - SACT Security Acoustic Ceiling Tile
- WALL FINISHES LEGEND:**
- EWC Epoxy Wall Coating
  - HPC High Performance Coating
  - PT Paint
- CEILING FINISHES LEGEND:**
- ECC Epoxy Ceiling Coating
  - HPC High Performance Coating
  - PF Prefinished
  - PT Paint
- WALL PROTECTION LEGEND:**
- ESRP Extruded Semi-Rigid PVCu Panel
  - FRL Fibre Reinforced Laminiate
  - FRP Fibreglass Reinforced Plastic
  - PVV Protective Vinyl Wallcovering
  - RHIS Rigid High Impact Sheet
  - WSSP Wetwall Solid Surface Panel
  - WWW Wetroom Vinyl Wallcovering
- FLOOR FINISHES LEGEND:**
- CFS Concrete Floor Sealer
  - EFC Epoxy Floor Coating
  - PFC Polyurethane Floor Coating
  - RAF Rubber Athletic Flooring
  - RSF Rubber Sheet Flooring
  - SCF Seamless Cushioned Flooring
  - SDRF Static-Dissipative Rubber Sheet Flooring
  - SDVF Static-Dissipative Vinyl Sheet Flooring
  - VSF Vinyl Sheet Flooring
  - WSVF Wetroom Safety Vinyl Sheet Flooring
- FLOOR BASE LEGEND:**
- FCB Flash Cove Base
  - RB Rubber Base
  - SCF Seamless Cushioned Flooring

**DOORS**

Types:

Type	Qty	Size (mm)	Material	Finish	Side Lt	Blinds	Protect	Privacy Film	Function	Card Reader	Mag Lock	Auto Opener	Hold Open	Hinges	Accessory 1	Accessory 2	Accessory 3	Closer
C	1	915 x 2135	Solid Core	FRL	<input type="checkbox"/>	<input type="checkbox"/>	1 Low	<input type="checkbox"/>	Storeroom	<input checked="" type="checkbox"/>	<input type="checkbox"/>	<input type="checkbox"/>	<input type="checkbox"/>	Butt Hinge				Surface

Door Remarks:  Security Grille  Anti-barricade strategy

**MILLWORK AND SPECIALTY CASEWORK**

Storage Requirements:

**UPPER UNITS** U1  U2  U3  U4  U5  U6  U7  U8

**LOWER UNITS** L1  L2  L3  L4  L5  L6  L7  L8  L9

**FULL-HEIGHT CABINETS** C1  C2  C3  C4  C5

**RECEPTION/TRANSACTION COUNTER / CARE TEAM STATION DESK** TC1  TC2

**UTILITY SINK AND COUNTER UNIT** UC1

**FINISHES**

Full-height Cabinet:   
 Upper Millwork:   
 Countertop:   
 Lower Millwork:   
 Shelf:

Remarks: Refer to Schedule 1, Section 6.12 (Division 12) for Specialty Casework. Items indicated are diagrammatic, provide specialty casework appropriate for the specific and specialized functions to be performed in the space and to accommodate Equipment. Refer to Appendix 1A, Section 2.20.2 T2. Public Spaces - CC for reception requirements

Category	Min. Length (mm)	Motorized Adjustable Height	Standing Height	Specialty Casework
3	6000	<input checked="" type="checkbox"/>	<input type="checkbox"/>	<input checked="" type="checkbox"/>

**MECHANICAL REQUIREMENTS**

<b>PLUMBING</b> (Quantity) Hand Hygiene Sink: <input type="text"/> Lavatory: <input type="text"/> Kitchen Sink: <input type="text"/> Seamless Kitchen Sink: <input type="text"/> Utility / Process Sink: <input type="text"/> Scrub Sink: <input type="text"/> Floor Sink: <input type="text"/> Plumbing Remarks: <input type="text"/>	Other Fixtures: <input type="checkbox"/> Shower <input type="checkbox"/> Tub <input type="checkbox"/> Ice Maker <input type="checkbox"/> Water Closet <input type="checkbox"/> Instantaneous Hot Water <input type="checkbox"/> Eyewash Station <input type="checkbox"/> Eyewash/Shower Station <input type="checkbox"/> Emergency Shower <input type="checkbox"/> Flush Rim Sink <input type="checkbox"/> Floor Drain <input type="checkbox"/> Water Bottle Refill Station Other: <input type="text"/>	<b>MED / NON-MED GASES</b> (Quantity) Oxygen: <input type="text"/> Medical Air: <input type="text"/> Medical Vacuum: <input type="text"/> Nitrous Oxide: <input type="text"/> CO2: <input type="text"/> AGSS: <input type="text"/> Nitrogen: <input type="text"/> Laboratory Air: <input type="text"/> Laboratory Vacuum: <input type="text"/> Utility Compressed Air: <input type="text"/> Gas Remarks: <input type="text"/>
--	--	---

**Appendix 1B Minimum Room Requirements**

Room Name:

Program Number(s):

1.	T2.03	7.		13.		19.		25.		31.		37.		43.
2.		8.		14.		20.		26.		32.		38.		44.
3.		9.		15.		21.		27.		33.		39.		45.
4.		10.		16.		22.		28.		34.		40.		46.
5.		11.		17.		23.		29.		35.		41.		47.
6.		12.		18.		24.		30.		36.		42.		48.

**ARCHITECTURAL REQUIREMENTS**

<b>WALL AND CEILING</b> Wall Material: <input type="text" value="ARGB 1.2m AFF, GB above"/> Finish: <input type="text" value="PT"/> Ceiling Material: <input type="text" value="ACT"/> Finish: <input type="text" value="PF"/>		<b>WALL PROTECTION</b> Type: <input type="text" value="FRL"/> <input checked="" type="checkbox"/> Corner Guards <input type="checkbox"/> Hand Rails <input type="checkbox"/> Bed Bumper / Locator Height: <input type="text" value="1350 mm"/> <input type="checkbox"/> Crash Rails <input checked="" type="checkbox"/> Chair Rail			<b>GLAZING</b> <input type="checkbox"/> Interior Glazing		<b>FLOORING TYPES</b> Material: <input type="text" value="RSF"/> Base: <input type="text" value="FCB"/>		<b>ROOM ACCESSORIES</b> <input checked="" type="checkbox"/> Coat Hooks <input type="checkbox"/> Ceiling Lift <input checked="" type="checkbox"/> Magnetic Whiteboard <input type="checkbox"/> Mirror <input type="checkbox"/> Infant Change Table <input type="checkbox"/> Privacy Curtain		
--	--	--	--	--	---	--	--	--	--	--	--

- LEGEND:**
- WALL AND CEILING LEGEND:**
- AC Architectural Ceiling
  - ACT Acoustic Ceiling Tile
  - ACT-C Cleanroom
  - ARGB Abuse-Resistant Gypsum Board
  - GB Gypsum Board
  - IRGB Impact-Resistant Gypsum Board
  - KLCT Kitchen Lay-in Ceiling Tile
  - MMRGB Moisture and Mould-Resistant Gypsum Board
  - SACT Security Acoustic Ceiling Tile
- WALL FINISHES LEGEND:**
- EWC Epoxy Wall Coating
  - HPC High Performance Coating
  - PT Paint
- CEILING FINISHES LEGEND:**
- ECC Epoxy Ceiling Coating
  - HPC High Performance Coating
  - PF Prefinished
  - PT Paint
- WALL PROTECTION LEGEND:**
- ESRP Extruded Semi-Rigid PVCu Panel
  - FRL Fibre Reinforced Laminate
  - FRP Fibreglass Reinforced Plastic
  - PVV Protective Vinyl Wallcovering
  - RHIS Rigid High Impact Sheet
  - WSSP Wetwall Solid Surface Panel
  - WVV Wetroom Vinyl Wallcovering
- FLOOR FINISHES LEGEND:**
- CFS Concrete Floor Sealer
  - EFC Epoxy Floor Coating
  - PFC Polyurethane Floor Coating
  - RAF Rubber Athletic Flooring
  - RSF Rubber Sheet Flooring
  - SCF Seamless Cushioned Flooring
  - SDRF Static-Dissipative Rubber Sheet Flooring
  - SDVF Static-Dissipative Vinyl Sheet Flooring
  - VSF Vinyl Sheet Flooring
  - WSVF Wetroom Safety Vinyl Sheet Flooring
- FLOOR BASE LEGEND:**
- FCB Flash Cove Base
  - RB Rubber Base
  - SCF Seamless Cushioned Flooring

**DOORS**

Types:

Type	Qty	Size (mm)	Material	Finish	Side Lt	Blinds	Protect	Privacy Film	Function	Card Reader	Mag Lock	Auto Opener	Hold Open	Hinges	Accessory 1	Accessory 2	Accessory 3	Closer
D	1	915 x 2135	Solid Core	FRL	<input type="checkbox"/>	<input type="checkbox"/>	1 Low	<input checked="" type="checkbox"/>	Classroom	<input type="checkbox"/>	<input type="checkbox"/>	<input type="checkbox"/>	<input type="checkbox"/>	Butt Hinge				Surface

Door Remarks:  Security Grille  Anti-barricade strategy

**MILLWORK AND SPECIALTY CASEWORK**

**UPPER UNITS** (U1-U8) **LOWER UNITS** (L1-L12) **RECEPTION/TRANSACTION COUNTER / CARE TEAM STATION DESK** (TC1-TC2) **UTILITY SINK AND COUNTER UNIT** (UC1)

Storage Requirements:

**FINISHES**

Full-height Cabinet:

Upper Millwork:

Countertop:

Lower Millwork:

Shelf:

Remarks:

Category	Min. Length (mm)	Motorized Adjustable Height	Standing Height	Specialty Casework
1	900	<input type="checkbox"/>	<input type="checkbox"/>	<input type="checkbox"/>

**MECHANICAL REQUIREMENTS**

<b>PLUMBING</b> (Quantity) Hand Hygiene Sink: <input type="text"/> Lavatory: <input type="text"/> Kitchen Sink: <input type="text"/> Seamless Kitchen Sink: <input type="text"/> Utility / Process Sink: <input type="text"/> Scrub Sink: <input type="text"/> Floor Sink: <input type="text"/> Plumbing Remarks: <input type="text"/>							Other Fixtures: <input type="checkbox"/> Shower <input type="checkbox"/> Tub <input type="checkbox"/> Ice Maker <input type="checkbox"/> Water Closet <input type="checkbox"/> Instantaneous Hot Water <input type="checkbox"/> Eyewash Station <input type="checkbox"/> Eyewash/Shower Station <input type="checkbox"/> Emergency Shower <input type="checkbox"/> Flush Rim Sink <input type="checkbox"/> Floor Drain <input type="checkbox"/> Water Bottle Refill Station Other <input type="text"/>				<b>MED / NON-MED GASES</b> (Quantity) Oxygen: <input type="text"/> Medical Air: <input type="text"/> Medical Vacuum: <input type="text"/> Nitrous Oxide: <input type="text"/> CO2: <input type="text"/> AGSS: <input type="text"/> Nitrogen: <input type="text"/> Laboratory Air: <input type="text"/> Laboratory Vacuum: <input type="text"/> Utility Compressed Air: <input type="text"/> Gas Remarks: <input type="text"/>				
---	--	--	--	--	--	--	---	--	--	--	--	--	--	--	--



**Appendix 1B Minimum Room Requirements**

Room Name:

Program Number(s):

1. T3.03	7.	13.	19.	25.	31.	37.	43.
2.	8.	14.	20.	26.	32.	38.	44.
3.	9.	15.	21.	27.	33.	39.	45.
4.	10.	16.	22.	28.	34.	40.	46.
5.	11.	17.	23.	29.	35.	41.	47.
6.	12.	18.	24.	30.	36.	42.	48.

**ARCHITECTURAL REQUIREMENTS**

<b>WALL AND CEILING</b> Wall Material: <input type="text" value="ARGB 1.2m AFF, GB above"/> Finish: <input type="text" value="PT"/> Ceiling Material: <input type="text" value="ACT"/> Finish: <input type="text" value="PF"/>	<b>WALL PROTECTION</b> Type: <input type="text"/> Height: <input type="text"/> <input type="checkbox"/> Corner Guards <input type="checkbox"/> Hand Rails <input type="checkbox"/> Bed Bumper / Locator <input type="checkbox"/> Crash Rails <input type="checkbox"/> Chair Rail	<b>GLAZING</b> <input checked="" type="checkbox"/> Interior Glazing	<b>FLOORING TYPES</b> Material: <input type="text"/> Base: <input type="text"/>	<b>ROOM ACCESSORIES</b> <input type="checkbox"/> Coat Hooks <input type="checkbox"/> Ceiling Lift <input type="checkbox"/> Magnetic Whiteboard <input type="checkbox"/> Mirror <input type="checkbox"/> Infant Change Table <input type="checkbox"/> Privacy Curtain
--	---	--	--	--

- LEGEND:**
- WALL AND CEILING LEGEND:**
- AC Architectural Ceiling
  - ACT Acoustic Ceiling Tile
  - ACT-C Cleanroom
  - ARGB Abuse-Resistant Gypsum Board
  - GB Gypsum Board
  - IRGB Impact-Resistant Gypsum Board
  - KLCT Kitchen Lay-in Ceiling Tile
  - MMRGB Moisture and Mould-Resistant Gypsum Board
  - SACT Security Acoustic Ceiling Tile
- WALL FINISHES LEGEND:**
- EWC Epoxy Wall Coating
  - HPC High Performance Coating
  - PT Paint
- CEILING FINISHES LEGEND:**
- ECC Epoxy Ceiling Coating
  - HPC High Performance Coating
  - PF Prefinished
  - PT Paint
- WALL PROTECTION LEGEND:**
- ESRP Extruded Semi-Rigid PVCu Panel
  - FRL Fibre Reinforced Laminate
  - FRP Fibreglass Reinforced Plastic
  - PVV Protective Vinyl Wallcovering
  - RHIS Rigid High Impact Sheet
  - WSSP Wetwall Solid Surface Panel
  - WVV Wetroom Vinyl Wallcovering
- FLOOR FINISHES LEGEND:**
- CFS Concrete Floor Sealer
  - EFC Epoxy Floor Coating
  - PFC Polyurethane Floor Coating
  - RAF Rubber Athletic Flooring
  - RSF Rubber Sheet Flooring
  - SCF Seamless Cushioned Flooring
  - SDRF Static-Dissipative Rubber Sheet Flooring
  - SDVF Static-Dissipative Vinyl Sheet Flooring
  - VSF Vinyl Sheet Flooring
  - WSVF Wetroom Safety Vinyl Sheet Flooring
- FLOOR BASE LEGEND:**
- FCB Flash Cove Base
  - RB Rubber Base
  - SCF Seamless Cushioned Flooring

**DOORS**

Types:

Type	Qty	Size (mm)	Material	Finish	Side Lt.	Blinds	Protect.	Privacy Film	Function	Card Reader	Mag Lock	Auto Opener	Hold Open	Hinges	Accessory 1	Accessory 2	Accessory 3	Closer
A2	1	1830 x 2135	Solid Core	FRL	<input type="checkbox"/>	<input type="checkbox"/>	1 Low	<input type="checkbox"/>	Storeroom	<input checked="" type="checkbox"/>	<input type="checkbox"/>	<input type="checkbox"/>	<input type="checkbox"/>	Butt Hinge	Astragal	Flush Bolt		Surface

Door Remarks:  Security Grille  Anti-barricade strategy



**MECHANICAL REQUIREMENTS**

<b>PLUMBING</b> (Quantity) Hygiene Sink: <input type="text"/> Lavatory: <input type="text"/> Kitchen Sink: <input type="text"/> Seamless Kitchen Sink: <input type="text"/> Utility / Process Sink: <input type="text"/> Scrub Sink: <input type="text"/> Floor Sink: <input type="text"/>	Other Fixtures: <input type="checkbox"/> Shower <input type="checkbox"/> Tub <input type="checkbox"/> Ice Maker <input type="checkbox"/> Water Closet <input type="checkbox"/> Instantaneous Hot Water	<input type="checkbox"/> Eyewash Station <input type="checkbox"/> Eyewash/Shower Station <input type="checkbox"/> Emergency Shower <input type="checkbox"/> Flush Rim Sink <input checked="" type="checkbox"/> Floor Drain <input type="checkbox"/> Water Bottle Refill Station Other: <input type="text"/>	<b>MED / NON-MED GASES</b> (Quantity) Oxygen: <input type="text"/> Medical Air: <input type="text"/> Medical Vacuum: <input type="text"/> Nitrous Oxide: <input type="text"/> CO2: <input type="text"/> AGSS: <input type="text"/> Nitrogen: <input type="text"/> Laboratory Air: <input type="text"/> Laboratory Vacuum: <input type="text"/> Utility Compressed Air: <input type="text"/>
---	---	--	--

Plumbing Remarks:

Gas Remarks:

**Appendix 1B Minimum Room Requirements**

Room Name:

Program Number(s):	1. T3.01	7.	13.	19.	25.	31.	37.	43.
	2.	8.	14.	20.	26.	32.	38.	44.
	3.	9.	15.	21.	27.	33.	39.	45.
	4.	10.	16.	22.	28.	34.	40.	46.
	5.	11.	17.	23.	29.	35.	41.	47.
	6.	12.	18.	24.	30.	36.	42.	48.

**ARCHITECTURAL REQUIREMENTS**

<b>WALL AND CEILING</b> Wall Material: <input type="text" value="ARGB 1.2m AFF, GB above"/> Finish: <input type="text" value="PT"/> Ceiling Material: <input type="text" value="ACT"/> Finish: <input type="text" value="PF"/>	<b>WALL PROTECTION</b> Type: <input type="text"/> <input type="checkbox"/> Corner Guards <input type="checkbox"/> Hand Rails <input type="checkbox"/> Bed Bumper / Locator Height: <input type="text"/> <input type="checkbox"/> Crash Rails <input type="checkbox"/> Chair Rail	<b>GLAZING</b> <input checked="" type="checkbox"/> Interior Glazing	<b>FLOORING TYPES</b> Material: <input type="text"/> Base: <input type="text"/> <input type="text" value="VSF"/>	<b>ROOM ACCESSORIES</b> <input type="checkbox"/> Coat Hooks <input type="checkbox"/> Ceiling Lift <input type="checkbox"/> Magnetic Whiteboard <input type="checkbox"/> Mirror <input type="checkbox"/> Infant Change Table <input type="checkbox"/> Privacy Curtain
--	--	--	--	--

- LEGEND:**
- WALL AND CEILING LEGEND:**
- AC Architectural Ceiling
  - ACT Acoustic Ceiling Tile
  - ACT-C Cleanroom
  - ARGB Abuse-Resistant Gypsum Board
  - GB Gypsum Board
  - IRGB Impact-Resistant Gypsum Board
  - KLCT Kitchen Lay-in Ceiling Tile
  - MMRGB Moisture and Mould-Resistant Gypsum Board
  - SACT Security Acoustic Ceiling Tile
- WALL FINISHES LEGEND:**
- EWC Epoxy Wall Coating
  - HPC High Performance Coating
  - PT Paint
- CEILING FINISHES LEGEND:**
- ECC Epoxy Ceiling Coating
  - HPC High Performance Coating
  - PF Prefinished
  - PT Paint
- WALL PROTECTION LEGEND:**
- ESRP Extruded Semi-Rigid PVCu Panel
  - FRL Fibre Reinforced Laminate
  - FRP Fibreglass Reinforced Plastic
  - PVV Protective Vinyl Wallcovering
  - RHIS Rigid High Impact Sheet
  - WSSP Wetwall Solid Surface Panel
  - WVV Wetroom Vinyl Wallcovering
- FLOOR FINISHES LEGEND:**
- CFS Concrete Floor Sealer
  - EFC Epoxy Floor Coating
  - PFC Polyurethane Floor Coating
  - RAF Rubber Athletic Flooring
  - RSF Rubber Sheet Flooring
  - SCF Seamless Cushioned Flooring
  - SDRF Static-Dissipative Rubber Sheet Flooring
  - SDVF Static-Dissipative Vinyl Sheet Flooring
  - VSF Vinyl Sheet Flooring
  - WSVF Wetroom Safety Vinyl Sheet Flooring
- FLOOR BASE LEGEND:**
- FCB Flash Cove Base
  - RB Rubber Base
  - SCF Seamless Cushioned Flooring

**DOORS**

Types:

Type	Qty	Size (mm)	Material	Finish	Side Lt	Blinds	Protect	Privacy Film	Function	Card Reader	Mag Lock	Auto Opener	Hold Open	Hinges	Accessory 1	Accessory 2	Accessory 3	Closer
A2	1	1830 x 2135	Solid Core	FRL	<input type="checkbox"/>	<input type="checkbox"/>	1 Low	<input type="checkbox"/>	Storeroom	<input checked="" type="checkbox"/>	<input type="checkbox"/>	<input type="checkbox"/>	<input type="checkbox"/>	Butt Hinge	Astragal	Flush Bolt		Surface

**DOOR REMARKS:**

Security Grille  
 Anti-barricade strategy

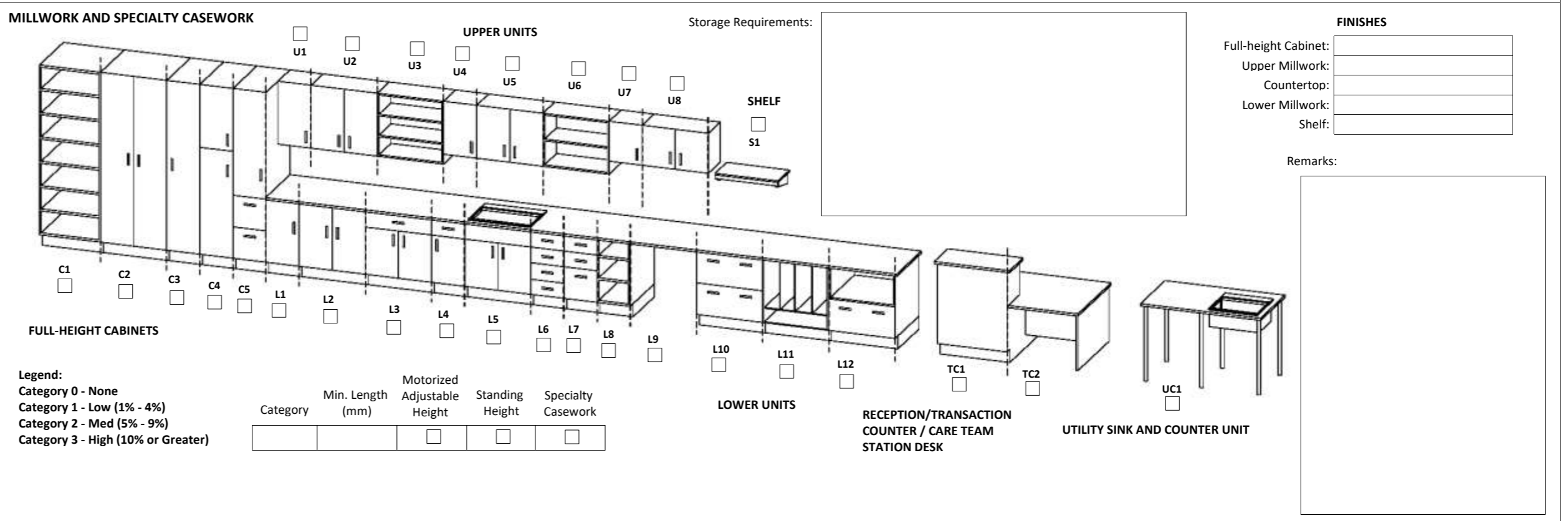

**MECHANICAL REQUIREMENTS**

<b>PLUMBING</b> (Quantity) Hygiene Sink: <input type="text"/> Lavatory: <input type="text"/> Kitchen Sink: <input type="text"/> Seamless Kitchen Sink: <input type="text"/> Utility / Process Sink: <input type="text"/> Scrub Sink: <input type="text"/> Floor Sink: <input type="text"/>	Other Fixtures: <input type="checkbox"/> Shower <input type="checkbox"/> Tub <input type="checkbox"/> Ice Maker <input type="checkbox"/> Water Closet <input type="checkbox"/> Instantaneous Hot Water <input type="checkbox"/> Eyewash Station <input type="checkbox"/> Eyewash/Shower Station <input type="checkbox"/> Emergency Shower <input type="checkbox"/> Flush Rim Sink <input type="checkbox"/> Floor Drain <input type="checkbox"/> Water Bottle Refill Station Other: <input type="text"/>	<b>MED / NON-MED GASES</b> (Quantity) Oxygen: <input type="text"/> Medical Air: <input type="text"/> Medical Vacuum: <input type="text"/> Nitrous Oxide: <input type="text"/> CO2: <input type="text"/> AGSS: <input type="text"/> Nitrogen: <input type="text"/> Laboratory Air: <input type="text"/> Laboratory Vacuum: <input type="text"/> Utility Compressed Air: <input type="text"/>

**Appendix 1B Minimum Room Requirements**

Room Name:

Program Number(s):	1. T4.04	7.	13.	19.	25.	31.	37.	43.
	2.	8.	14.	20.	26.	32.	38.	44.
	3.	9.	15.	21.	27.	33.	39.	45.
	4.	10.	16.	22.	28.	34.	40.	46.
	5.	11.	17.	23.	29.	35.	41.	47.
	6.	12.	18.	24.	30.	36.	42.	48.

**ARCHITECTURAL REQUIREMENTS**

<b>WALL AND CEILING</b> Wall Material: <input type="text" value="ARGB 1.2m AFF, GB above"/> Finish: <input type="text" value="PT"/> Ceiling Material: <input type="text" value="ACT"/> Finish: <input type="text" value="PF"/>		<b>WALL PROTECTION</b> Type: <input type="text" value="FRL"/> <input checked="" type="checkbox"/> Corner Guards <input type="checkbox"/> Hand Rails <input type="checkbox"/> Bed Bumper / Locator Height: <input type="text" value="1350 mm"/> <input type="checkbox"/> Crash Rails <input type="checkbox"/> Chair Rail		<b>GLAZING</b> <input checked="" type="checkbox"/> Interior Glazing		<b>FLOORING TYPES</b> Material: <input type="text" value="VSF"/> Base: <input type="text" value="RB"/>		<b>ROOM ACCESSORIES</b> <input type="checkbox"/> Coat Hooks <input type="checkbox"/> Ceiling Lift <input type="checkbox"/> Magnetic Whiteboard <input type="checkbox"/> Mirror <input type="checkbox"/> Infant Change Table <input type="checkbox"/> Privacy Curtain	
--	--	---	--	--	--	---	--	--	--

- LEGEND:**
- WALL AND CEILING LEGEND:**
- AC Architectural Ceiling
  - ACT Acoustic Ceiling Tile
  - ACT-C Cleanroom
  - ARGB Abuse-Resistant Gypsum Board
  - GB Gypsum Board
  - IRGB Impact-Resistant Gypsum Board
  - KLCT Kitchen Lay-in Ceiling Tile
  - MMRGB Moisture and Mould-Resistant Gypsum Board
  - SACT Security Acoustic Ceiling Tile
- WALL FINISHES LEGEND:**
- EWC Epoxy Wall Coating
  - HPC High Performance Coating
  - PT Paint
- CEILING FINISHES LEGEND:**
- ECC Epoxy Ceiling Coating
  - HPC High Performance Coating
  - PF Prefinished
  - PT Paint
- WALL PROTECTION LEGEND:**
- ESRP Extruded Semi-Rigid PVCu Panel
  - FRL Fibre Reinforced Laminate
  - FRP Fibreglass Reinforced Plastic
  - PVV Protective Vinyl Wallcovering
  - RHIS Rigid High Impact Sheet
  - WSSP Wetwall Solid Surface Panel
  - WVV Wetroom Vinyl Wallcovering
- FLOOR FINISHES LEGEND:**
- CFS Concrete Floor Sealer
  - EFC Epoxy Floor Coating
  - PFC Polyurethane Floor Coating
  - RAF Rubber Athletic Flooring
  - RSF Rubber Sheet Flooring
  - SCF Seamless Cushioned Flooring
  - SDRF Static-Dissipative Rubber Sheet Flooring
  - SDVF Static-Dissipative Vinyl Sheet Flooring
  - VSF Vinyl Sheet Flooring
  - WSVF Wetroom Safety Vinyl Sheet Flooring
- FLOOR BASE LEGEND:**
- FCB Flash Cove Base
  - RB Rubber Base
  - SCF Seamless Cushioned Flooring

**DOORS**

Types:

Type	Qty	Size (mm)	Material	Finish	Side Lt	Blinds	Protect	Privacy Film	Function	Card Reader	Mag Lock	Auto Opener	Hold Open	Hinges	Accessory 1	Accessory 2	Accessory 3	Closer
C	1	1065 x 2135	Solid Core	FRL	<input type="checkbox"/>	<input type="checkbox"/>	1 Low	<input checked="" type="checkbox"/>	Classroom	<input type="checkbox"/>	<input type="checkbox"/>	<input type="checkbox"/>	<input checked="" type="checkbox"/>	Butt Hinge				Surface

Door Remarks:  Security Grille  Anti-barricade strategy

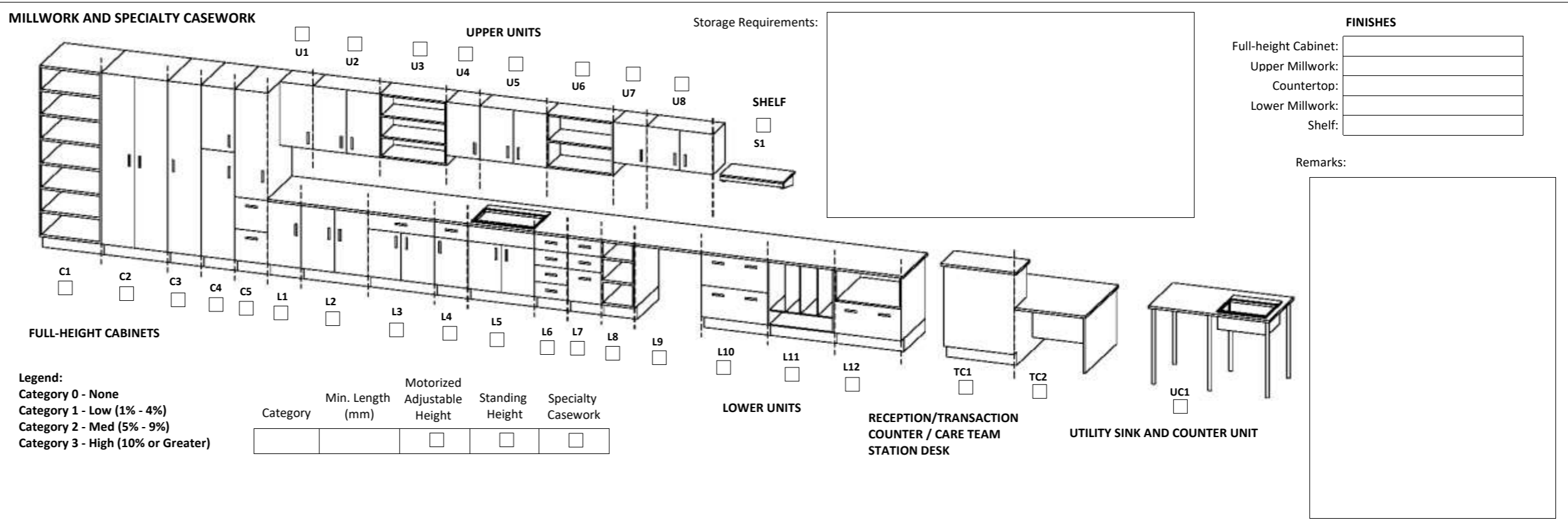

**MECHANICAL REQUIREMENTS**

<b>PLUMBING</b> (Quantity) Hand Hygiene Sink: <input type="text" value="1"/> Lavatory: <input type="text"/> Kitchen Sink: <input type="text"/> Seamless Kitchen Sink: <input type="text"/> Utility / Process Sink: <input type="text"/> Scrub Sink: <input type="text"/> Floor Sink: <input type="text"/>		Other Fixtures: <input type="checkbox"/> Shower <input type="checkbox"/> Eyewash Station <input type="checkbox"/> Tub <input type="checkbox"/> Eyewash/Shower Station <input type="checkbox"/> Ice Maker <input type="checkbox"/> Emergency Shower <input type="checkbox"/> Water Closet <input type="checkbox"/> Flush Rim Sink <input type="checkbox"/> Instantaneous Hot Water <input type="checkbox"/> Floor Drain <input type="checkbox"/> Water Bottle Refill Station Other: <input type="text"/>		<b>MED / NON-MED GASES</b> (Quantity) Oxygen: <input type="text"/> Medical Air: <input type="text"/> Medical Vacuum: <input type="text"/> Nitrous Oxide: <input type="text"/> CO2: <input type="text"/> AGSS: <input type="text"/> Nitrogen: <input type="text"/> Laboratory Air: <input type="text"/> Laboratory Vacuum: <input type="text"/> Utility Compressed Air: <input type="text"/>	
Plumbing Remarks: <input type="text"/>		Gas Remarks: <input type="text"/>			



**Appendix 1B Minimum Room Requirements**

Room Name:

Program Number(s):

1. T1.02.02	7.	13.	19.	25.	31.	37.	43.
2.	8.	14.	20.	26.	32.	38.	44.
3.	9.	15.	21.	27.	33.	39.	45.
4.	10.	16.	22.	28.	34.	40.	46.
5.	11.	17.	23.	29.	35.	41.	47.
6.	12.	18.	24.	30.	36.	42.	48.

**ARCHITECTURAL REQUIREMENTS**

<b>WALL AND CEILING</b> Wall Material: <input type="text" value="ARGB 1.2m AFF, GB above"/> Finish: <input type="text" value="PT"/> Ceiling Material: <input type="text" value="ACT"/> Finish: <input type="text" value="PF"/>	<b>WALL PROTECTION</b> Type: <input type="text" value="WVW"/> <input type="checkbox"/> Corner Guards <input type="checkbox"/> Hand Rails <input type="checkbox"/> Bed Bumper / Locator Height: <input type="text" value="1350 mm"/> <input type="checkbox"/> Crash Rails <input type="checkbox"/> Chair Rail	<b>GLAZING</b> <input type="checkbox"/> Interior Glazing	<b>FLOORING TYPES</b> Material: <input type="text" value="VSF"/> Base: <input type="text" value="FCB"/>	<b>ROOM ACCESSORIES</b> <input type="checkbox"/> Coat Hooks <input type="checkbox"/> Ceiling Lift <input type="checkbox"/> Magnetic Whiteboard <input type="checkbox"/> Mirror <input type="checkbox"/> Infant Change Table <input type="checkbox"/> Privacy Curtain
--	--	---	--	--

- LEGEND:**
- WALL AND CEILING LEGEND:**
- AC Architectural Ceiling
  - ACT Acoustic Ceiling Tile
  - ACT-C Cleanroom
  - ARGB Abuse-Resistant Gypsum Board
  - GB Gypsum Board
  - IRGB Impact-Resistant Gypsum Board
  - KLCT Kitchen Lay-in Ceiling Tile
  - MMRGB Moisture and Mould-Resistant Gypsum Board
  - SACT Security Acoustic Ceiling Tile
- WALL FINISHES LEGEND:**
- EWC Epoxy Wall Coating
  - HPC High Performance Coating
  - PT Paint
- CEILING FINISHES LEGEND:**
- ECC Epoxy Ceiling Coating
  - HPC High Performance Coating
  - PF Prefinished
  - PT Paint
- WALL PROTECTION LEGEND:**
- ESRP Extruded Semi-Rigid PVCu Panel
  - FRL Fibre Reinforced Laminate
  - FRP Fibreglass Reinforced Plastic
  - PVW Protective Vinyl Wallcovering
  - RHIS Rigid High Impact Sheet
  - WSSP Wetwall Solid Surface Panel
  - WVV Wetroom Vinyl Wallcovering
- FLOOR FINISHES LEGEND:**
- CFS Concrete Floor Sealer
  - EFC Epoxy Floor Coating
  - PFC Polyurethane Floor Coating
  - RAF Rubber Athletic Flooring
  - RSF Rubber Sheet Flooring
  - SCF Seamless Cushioned Flooring
  - SDRF Static-Dissipative Rubber Sheet Flooring
  - SDVF Static-Dissipative Vinyl Sheet Flooring
  - VSF Vinyl Sheet Flooring
  - WSVF Wetroom Safety Vinyl Sheet Flooring
- FLOOR BASE LEGEND:**
- FCB Flash Cove Base
  - RB Rubber Base
  - SCF Seamless Cushioned Flooring

**DOORS**

Types:

Type	Qty	Size (mm)	Material	Finish	Side Lt	Blinds	Protect	Privacy Film	Function	Card Reader	Mag Lock	Auto Opener	Hold Open	Hinges	Accessory 1	Accessory 2	Accessory 3	Closer

Door Remarks:  Security Grille  Anti-barricade strategy

**MILLWORK AND SPECIALTY CASEWORK**

Storage Requirements:

**UPPER UNITS** (U1-U8) **SHELF** (S1)

**LOWER UNITS** (L1-L12) **RECEPTION/TRANSACTION COUNTER / CARE TEAM STATION DESK** (TC1, TC2) **UTILITY SINK AND COUNTER UNIT** (UC1)

**FULL-HEIGHT CABINETS** (C1-C5)

**Legend:**

Category	Min. Length (mm)	Motorized Adjustable Height	Standing Height	Specialty Casework
Category 0 - None				
Category 1 - Low (1% - 4%)				
Category 2 - Med (5% - 9%)				
Category 3 - High (10% or Greater)				

**FINISHES**

Full-height Cabinet:   
 Upper Millwork:   
 Countertop:   
 Lower Millwork:   
 Shelf:

Remarks:

**MECHANICAL REQUIREMENTS**

**PLUMBING**

Hand Hygiene Sink:	Lavatory:	Kitchen Sink:	Seamless Kitchen Sink:	Utility / Process Sink:	Scrub Sink:	Floor Sink:
<input type="text"/>	<input type="text"/>	<input type="text"/>	<input type="text"/>	<input type="text"/>	<input type="text"/>	<input type="text"/>

Plumbing Remarks:

**Other Fixtures:**

- Shower
- Tub
- Ice Maker
- Water Closet
- Instantaneous Hot Water
- Eyewash Station
- Eyewash/Shower Station
- Emergency Shower
- Flush Rim Sink
- Floor Drain
- Water Bottle Refill Station

Other:

**MED / NON-MED GASES**

Oxygen:	Medical Air:	Medical Vacuum:	Nitrous Oxide:	CO2:	AGSS:	Nitrogen:	Laboratory Air:	Laboratory Vacuum:	Utility Compressed Air:
<input type="text"/>	<input type="text"/>	<input type="text"/>	<input type="text"/>	<input type="text"/>	<input type="text"/>	<input type="text"/>	<input type="text"/>	<input type="text"/>	<input type="text"/>

Gas Remarks:

**Appendix 1B Minimum Room Requirements**

Room Name:

Program Number(s):

1. T1.02.01	7.	13.	19.	25.	31.	37.	43.
2.	8.	14.	20.	26.	32.	38.	44.
3.	9.	15.	21.	27.	33.	39.	45.
4.	10.	16.	22.	28.	34.	40.	46.
5.	11.	17.	23.	29.	35.	41.	47.
6.	12.	18.	24.	30.	36.	42.	48.

**ARCHITECTURAL REQUIREMENTS**

<b>WALL AND CEILING</b> Wall Material: <input type="text" value="ARGB 1.2m AFF, GB above"/> Finish: <input type="text" value="PT"/> Ceiling Material: <input type="text" value="ACT"/> Finish: <input type="text" value="PF"/>	<b>WALL PROTECTION</b> Type: <input type="text"/> Height: <input type="text"/> <input type="checkbox"/> Corner Guards <input type="checkbox"/> Hand Rails <input type="checkbox"/> Bed Bumper / Locator <input type="checkbox"/> Crash Rails <input type="checkbox"/> Chair Rail	<b>GLAZING</b> <input type="checkbox"/> Interior Glazing	<b>FLOORING TYPES</b> Material: <input type="text" value="VSF"/> Base: <input type="text" value="FCB"/>	<b>ROOM ACCESSORIES</b> <input type="checkbox"/> Coat Hooks <input type="checkbox"/> Ceiling Lift <input type="checkbox"/> Magnetic Whiteboard <input type="checkbox"/> Mirror <input type="checkbox"/> Infant Change Table <input type="checkbox"/> Privacy Curtain
--	---	---	--	--

- LEGEND:**
- WALL AND CEILING LEGEND:**
- AC Architectural Ceiling
  - ACT Acoustic Ceiling Tile
  - ACT-C Cleanroom
  - ARGB Abuse-Resistant Gypsum Board
  - GB Gypsum Board
  - IRGB Impact-Resistant Gypsum Board
  - KLCT Kitchen Lay-in Ceiling Tile
  - MMRGB Moisture and Mould-Resistant Gypsum Board
  - SACT Security Acoustic Ceiling Tile
- WALL FINISHES LEGEND:**
- EWC Epoxy Wall Coating
  - HPC High Performance Coating
  - PT Paint
- CEILING FINISHES LEGEND:**
- ECC Epoxy Ceiling Coating
  - HPC High Performance Coating
  - PF Prefinished
  - PT Paint
- WALL PROTECTION LEGEND:**
- ESRP Extruded Semi-Rigid PVCu Panel
  - FRL Fibre Reinforced Laminate
  - FRP Fibreglass Reinforced Plastic
  - PVV Protective Vinyl Wallcovering
  - RHIS Rigid High Impact Sheet
  - WSSP Wetwall Solid Surface Panel
  - WVV Wetroom Vinyl Wallcovering
- FLOOR FINISHES LEGEND:**
- CFS Concrete Floor Sealer
  - EFC Epoxy Floor Coating
  - PFC Polyurethane Floor Coating
  - RAF Rubber Athletic Flooring
  - RSF Rubber Sheet Flooring
  - SCF Seamless Cushioned Flooring
  - SDRF Static-Dissipative Rubber Sheet Flooring
  - SDVF Static-Dissipative Vinyl Sheet Flooring
  - VSF Vinyl Sheet Flooring
  - WSVF Wetroom Safety Vinyl Sheet Flooring
- FLOOR BASE LEGEND:**
- FCB Flash Cove Base
  - RB Rubber Base
  - SCF Seamless Cushioned Flooring

**DOORS**

Types:

Type:Qty:	Size (mm):	Material:	Finish:	Side Lt:	Blinds:	Protect.:	Privacy Film:	Function:	Card Reader:	Mag Lock:	Auto Opener:	Hold Open:	Hinges:	Accessory 1:	Accessory 2:	Accessory 3:	Closer:

Door Remarks:

Security Grille  
 Anti-barricade strategy

**MILLWORK AND SPECIALTY CASEWORK**

Storage Requirements:

**UPPER UNITS** (U1-U8)

**LOWER UNITS** (L1-L12)

**RECEPTION/TRANSACTION COUNTER / CARE TEAM STATION DESK** (TC1, TC2)

**UTILITY SINK AND COUNTER UNIT** (UC1)

**SHELF** (S1)

**FULL-HEIGHT CABINETS** (C1-C5)

**Legend:**

Category	Min. Length (mm)	Motorized Adjustable Height	Standing Height	Specialty Casework
Category 0 - None				
Category 1 - Low (1% - 4%)				
Category 2 - Med (5% - 9%)				
Category 3 - High (10% or Greater)				

**FINISHES**

Full-height Cabinet:   
 Upper Millwork:   
 Countertop:   
 Lower Millwork:   
 Shelf:

Remarks:

**MECHANICAL REQUIREMENTS**

**PLUMBING** (Quantity)

Hygiene Sink:	Lavatory:	Kitchen Sink:	Seamless Kitchen Sink:	Utility / Process Sink:	Scrub Sink:	Floor Sink:

Plumbing Remarks:

**Other Fixtures:**

- Shower
- Tub
- Ice Maker
- Water Closet
- Instantaneous Hot Water
- Eyewash Station
- Eyewash/Shower Station
- Emergency Shower
- Flush Rim Sink
- Floor Drain
- Water Bottle Refill Station

Other:

**MED / NON-MED GASES** (Quantity)

Oxygen:	Medical Air:	Medical Vacuum:	Nitrous Oxide:	CO2:	AGSS:	Nitrogen:	Laboratory Air:	Laboratory Vacuum:	Utility Compressed Air:

Gas Remarks:

**Appendix 1B Minimum Room Requirements**

Room Name:

Program Number(s):

1. T1.02.05	7.	13.	19.	25.	31.	37.	43.
2.	8.	14.	20.	26.	32.	38.	44.
3.	9.	15.	21.	27.	33.	39.	45.
4.	10.	16.	22.	28.	34.	40.	46.
5.	11.	17.	23.	29.	35.	41.	47.
6.	12.	18.	24.	30.	36.	42.	48.

**ARCHITECTURAL REQUIREMENTS**

<b>WALL AND CEILING</b> Wall Material: <input type="text" value="ARGB 1.2m AFF, GB above"/> Finish: <input type="text" value="PT"/> Ceiling Material: <input type="text" value="ACT"/> Finish: <input type="text" value="PF"/>	<b>WALL PROTECTION</b> Type: <input type="text" value="PVW"/> <input checked="" type="checkbox"/> Corner Guards <input type="checkbox"/> Hand Rails <input type="checkbox"/> Bed Bumper / Locator Height: <input type="text" value="1350 mm"/> <input type="checkbox"/> Crash Rails <input type="checkbox"/> Chair Rail	<b>GLAZING</b> <input type="checkbox"/> Interior Glazing	<b>FLOORING TYPES</b> Material: <input type="text" value="VSF"/> Base: <input type="text" value="FCB"/>	<b>ROOM ACCESSORIES</b> <input type="checkbox"/> Coat Hooks <input type="checkbox"/> Ceiling Lift <input type="checkbox"/> Magnetic Whiteboard <input type="checkbox"/> Mirror <input type="checkbox"/> Infant Change Table <input type="checkbox"/> Privacy Curtain
--	---	---	--	--

- LEGEND:**
- WALL AND CEILING LEGEND:**
- AC Architectural Ceiling
  - ACT Acoustic Ceiling Tile
  - ACT-C Cleanroom
  - ARGB Abuse-Resistant Gypsum Board
  - GB Gypsum Board
  - IRGB Impact-Resistant Gypsum Board
  - KLCT Kitchen Lay-in Ceiling Tile
  - MMRGB Moisture and Mould-Resistant Gypsum Board
  - SACT Security Acoustic Ceiling Tile
- WALL FINISHES LEGEND:**
- EWC Epoxy Wall Coating
  - HPC High Performance Coating
  - PT Paint
- CEILING FINISHES LEGEND:**
- ECC Epoxy Ceiling Coating
  - HPC High Performance Coating
  - PF Prefinished
  - PT Paint
- WALL PROTECTION LEGEND:**
- ESRP Extruded Semi-Rigid PVCu Panel
  - FRL Fibre Reinforced Laminate
  - FRP Fibreglass Reinforced Plastic
  - PVW Protective Vinyl Wallcovering
  - RHIS Rigid High Impact Sheet
  - WSSP Wetwall Solid Surface Panel
  - WVV Wetroom Vinyl Wallcovering
- FLOOR FINISHES LEGEND:**
- CFS Concrete Floor Sealer
  - EFC Epoxy Floor Coating
  - PFC Polyurethane Floor Coating
  - RAF Rubber Athletic Flooring
  - RSF Rubber Sheet Flooring
  - SCF Seamless Cushioned Flooring
  - SDRF Static-Dissipative Rubber Sheet Flooring
  - SDVF Static-Dissipative Vinyl Sheet Flooring
  - VSF Vinyl Sheet Flooring
  - WSVF Wetroom Safety Vinyl Sheet Flooring
- FLOOR BASE LEGEND:**
- FCB Flash Cove Base
  - RB Rubber Base
  - SCF Seamless Cushioned Flooring

**DOORS**

Types:

Type	Qty	Size (mm)	Material	Finish	Side Lt	Blinds	Protect	Privacy Film	Function	Card Reader	Mag Lock	Auto Opener	Hold Open	Hinges	Accessory 1	Accessory 2	Accessory 3	Closer
C	1	915 x 2135	Solid Core	FRL	<input type="checkbox"/>	<input type="checkbox"/>	2 High	<input checked="" type="checkbox"/>	Storeroom	<input checked="" type="checkbox"/>	<input type="checkbox"/>	<input type="checkbox"/>	<input type="checkbox"/>	Cont. Swing Clear				Surface

**DOOR REMARKS:**

Security Grille  
 Anti-barricade strategy

**MILLWORK AND SPECIALTY CASEWORK**

Storage Requirements:

**UPPER UNITS:** U1, U2, U3, U4, U5, U6, U7, U8

**LOWER UNITS:** L1, L2, L3, L4, L5, L6, L7, L8, L9, L10, L11, L12

**RECEPTION/TRANSACTION COUNTER / CARE TEAM STATION DESK:** TC1, TC2

**UTILITY SINK AND COUNTER UNIT:** UC1

**SHELF:** S1

**FULL-HEIGHT CABINETS:** C1, C2, C3, C4, C5

**Legend:**

Category	Min. Length (mm)	Motorized Adjustable Height	Standing Height	Specialty Casework
Category 0 - None		<input type="checkbox"/>	<input type="checkbox"/>	<input type="checkbox"/>
Category 1 - Low (1% - 4%)		<input type="checkbox"/>	<input type="checkbox"/>	<input type="checkbox"/>
Category 2 - Med (5% - 9%)		<input type="checkbox"/>	<input type="checkbox"/>	<input type="checkbox"/>
Category 3 - High (10% or Greater)		<input type="checkbox"/>	<input type="checkbox"/>	<input type="checkbox"/>

**FINISHES**

Full-height Cabinet:   
 Upper Millwork:   
 Countertop:   
 Lower Millwork:   
 Shelf:

**REMARKS:**

**MECHANICAL REQUIREMENTS**

<b>PLUMBING</b> (Quantity) Hand Hygiene Sink: <input type="text"/> Lavatory: <input type="text"/> Kitchen Sink: <input type="text"/> Seamless Kitchen Sink: <input type="text"/> Utility / Process Sink: <input type="text"/> Scrub Sink: <input type="text"/> Floor Sink: <input type="text"/> Plumbing Remarks: <input type="text"/>	Other Fixtures: <input type="checkbox"/> Shower <input type="checkbox"/> Tub <input type="checkbox"/> Ice Maker <input type="checkbox"/> Water Closet <input type="checkbox"/> Instantaneous Hot Water <input type="checkbox"/> Eyewash Station <input type="checkbox"/> Eyewash/Shower Station <input type="checkbox"/> Emergency Shower <input type="checkbox"/> Flush Rim Sink <input type="checkbox"/> Floor Drain <input type="checkbox"/> Water Bottle Refill Station Other: <input type="text"/>	<b>MED / NON-MED GASES</b> (Quantity) Oxygen: <input type="text"/> Medical Air: <input type="text"/> Medical Vacuum: <input type="text"/> Nitrous Oxide: <input type="text"/> CO2: <input type="text"/> AGSS: <input type="text"/> Nitrogen: <input type="text"/> Laboratory Air: <input type="text"/> Laboratory Vacuum: <input type="text"/> Utility Compressed Air: <input type="text"/> Gas Remarks: <input type="text"/>
---	---	---



**Appendix 1B Minimum Room Requirements**

Room Name:

Program Number(s):	1. T3.04	7.	13.	19.	25.	31.	37.	43.
	2.	8.	14.	20.	26.	32.	38.	44.
	3.	9.	15.	21.	27.	33.	39.	45.
	4.	10.	16.	22.	28.	34.	40.	46.
	5.	11.	17.	23.	29.	35.	41.	47.
	6.	12.	18.	24.	30.	36.	42.	48.

**ARCHITECTURAL REQUIREMENTS**

<b>WALL AND CEILING</b> Wall Material: <input type="text" value="ARGB 1.2m AFF, GB above"/> Finish: <input type="text" value="PT"/> Ceiling Material: <input type="text" value="ACT"/> Finish: <input type="text" value="PF"/>	<b>WALL PROTECTION</b> Type: <input type="text"/> <input type="checkbox"/> Corner Guards <input type="checkbox"/> Hand Rails <input type="checkbox"/> Bed Bumper / Locator Height: <input type="text"/> <input type="checkbox"/> Crash Rails <input type="checkbox"/> Chair Rail	<b>GLAZING</b> <input type="checkbox"/> Interior Glazing	<b>FLOORING TYPES</b> Material: <input type="text"/> Base: <input type="text"/>	<b>ROOM ACCESSORIES</b> <input type="checkbox"/> Coat Hooks <input type="checkbox"/> Ceiling Lift <input type="checkbox"/> Magnetic Whiteboard <input type="checkbox"/> Mirror <input type="checkbox"/> Infant Change Table <input type="checkbox"/> Privacy Curtain
				Door Remarks: <input type="text"/>

- LEGEND:**
- WALL AND CEILING LEGEND:**
- AC Architectural Ceiling
  - ACT Acoustic Ceiling Tile
  - ACT-C Cleanroom
  - ARGB Abuse-Resistant Gypsum Board
  - GB Gypsum Board
  - IRGB Impact-Resistant Gypsum Board
  - KLCT Kitchen Lay-in Ceiling Tile
  - MMRGB Moisture and Mould-Resistant Gypsum Board
  - SACT Security Acoustic Ceiling Tile
- WALL FINISHES LEGEND:**
- EWC Epoxy Wall Coating
  - HPC High Performance Coating
  - PT Paint
- CEILING FINISHES LEGEND:**
- ECC Epoxy Ceiling Coating
  - HPC High Performance Coating
  - PF Prefinished
  - PT Paint
- WALL PROTECTION LEGEND:**
- ESRP Extruded Semi-Rigid PVCu Panel
  - FRL Fibre Reinforced Laminate
  - FRP Fibreglass Reinforced Plastic
  - PVV Protective Vinyl Wallcovering
  - RHIS Rigid High Impact Sheet
  - WSSP Wetwall Solid Surface Panel
  - WVV Wetroom Vinyl Wallcovering
- FLOOR FINISHES LEGEND:**
- CFS Concrete Floor Sealer
  - EFC Epoxy Floor Coating
  - PFC Polyurethane Floor Coating
  - RAF Rubber Athletic Flooring
  - RSF Rubber Sheet Flooring
  - SCF Seamless Cushioned Flooring
  - SDRF Static-Dissipative Rubber Sheet Flooring
  - SDVF Static-Dissipative Vinyl Sheet Flooring
  - VSF Vinyl Sheet Flooring
  - WSVF Wetroom Safety Vinyl Sheet Flooring
- FLOOR BASE LEGEND:**
- FCB Flash Cove Base
  - RB Rubber Base
  - SCF Seamless Cushioned Flooring

**DOORS**

Types:

Type	Qty	Size (mm)	Material	Finish	Side Lt.	Blinds	Protect.	Privacy Film	Function	Card Reader	Mag Lock	Auto Opener	Hold Open	Hinges	Accessory 1	Accessory 2	Accessory 3	Closer
C	2	1220 x 2135	Solid Core	FRL	<input type="checkbox"/>	<input type="checkbox"/>	2 High	<input checked="" type="checkbox"/>	Storeroom	<input checked="" type="checkbox"/>	<input type="checkbox"/>	<input type="checkbox"/>	<input checked="" type="checkbox"/>	Cont. Swing Clear				Surface

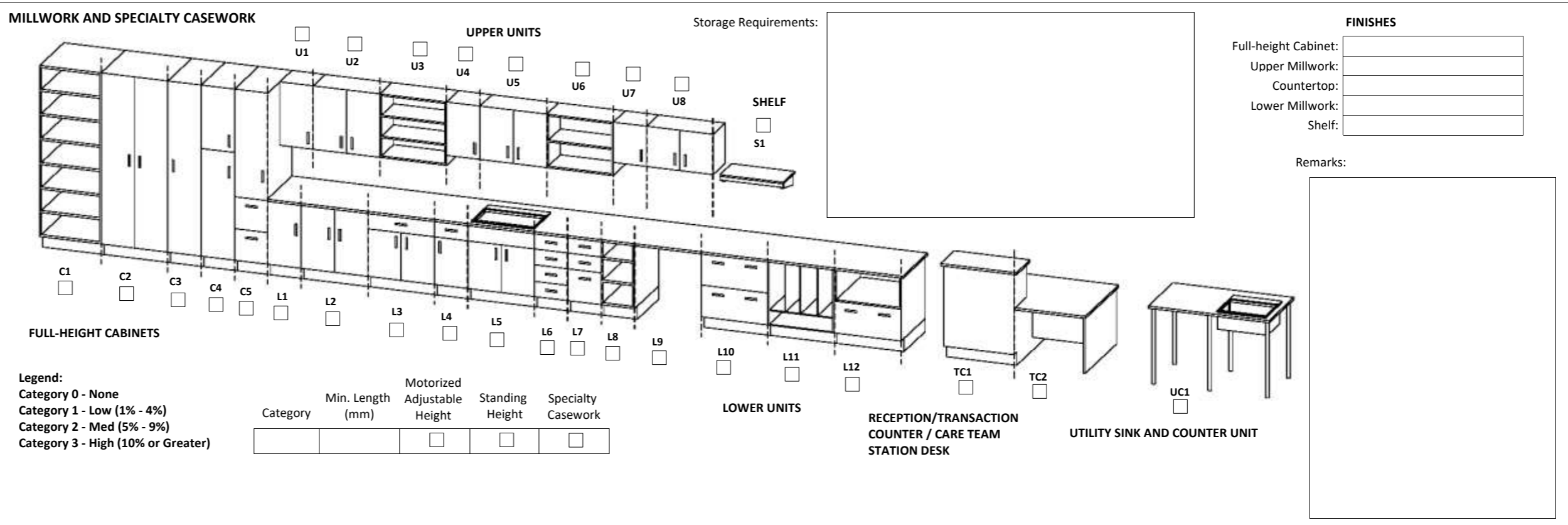

**MECHANICAL REQUIREMENTS**

<b>PLUMBING</b> (Quantity) Hygiene Sink: <input type="text"/> Lavatory: <input type="text"/> Kitchen Sink: <input type="text"/> Seamless Kitchen Sink: <input type="text"/> Utility / Process Sink: <input type="text"/> Scrub Sink: <input type="text"/> Floor Sink: <input type="text"/> Plumbing Remarks: <input type="text"/>	Other Fixtures: <input type="checkbox"/> Shower <input type="checkbox"/> Tub <input type="checkbox"/> Ice Maker <input type="checkbox"/> Water Closet <input type="checkbox"/> Instantaneous Hot Water	<input type="checkbox"/> Eyewash Station <input type="checkbox"/> Eyewash/Shower Station <input type="checkbox"/> Emergency Shower <input type="checkbox"/> Flush Rim Sink <input type="checkbox"/> Floor Drain <input type="checkbox"/> Water Bottle Refill Station Other: <input type="text"/>	<b>MED / NON-MED GASES</b> (Quantity) Oxygen: <input type="text"/> Medical Air: <input type="text"/> Medical Vacuum: <input type="text"/> Nitrous Oxide: <input type="text"/> CO2: <input type="text"/> AGSS: <input type="text"/> Nitrogen: <input type="text"/> Laboratory Air: <input type="text"/> Laboratory Vacuum: <input type="text"/> Utility Compressed Air: <input type="text"/> Gas Remarks: <input type="text"/>
---	---	---	---

**Appendix 1B Minimum Room Requirements**

Room Name:

Program Number(s):

1. T3.02	7.	13.	19.	25.	31.	37.	43.
2.	8.	14.	20.	26.	32.	38.	44.
3.	9.	15.	21.	27.	33.	39.	45.
4.	10.	16.	22.	28.	34.	40.	46.
5.	11.	17.	23.	29.	35.	41.	47.
6.	12.	18.	24.	30.	36.	42.	48.

**ARCHITECTURAL REQUIREMENTS**

<b>WALL AND CEILING</b> Wall Material: <input type="text" value="ARGB 1.2m AFF, GB above"/> Finish: <input type="text" value="PT"/> Ceiling Material: <input type="text" value="ACT"/> Finish: <input type="text" value="PF"/>	<b>WALL PROTECTION</b> Type: <input type="text"/> <input type="checkbox"/> Corner Guards <input type="checkbox"/> Hand Rails <input type="checkbox"/> Bed Bumper / Locator Height: <input type="text"/> <input type="checkbox"/> Crash Rails <input type="checkbox"/> Chair Rail	<b>GLAZING</b> <input type="checkbox"/> Interior Glazing	<b>FLOORING TYPES</b> Material: <input type="text"/> Base: <input type="text"/>	<b>ROOM ACCESSORIES</b> <input type="checkbox"/> Coat Hooks <input type="checkbox"/> Ceiling Lift <input type="checkbox"/> Magnetic Whiteboard <input type="checkbox"/> Mirror <input type="checkbox"/> Infant Change Table <input type="checkbox"/> Privacy Curtain
--	--	---	--	--

- LEGEND:**
- WALL AND CEILING LEGEND:**
- AC Architectural Ceiling
  - ACT Acoustic Ceiling Tile
  - ACT-C Cleanroom
  - ARGB Abuse-Resistant Gypsum Board
  - GB Gypsum Board
  - IRGB Impact-Resistant Gypsum Board
  - KLCT Kitchen Lay-in Ceiling Tile
  - MMRGB Moisture and Mould-Resistant Gypsum Board
  - SACT Security Acoustic Ceiling Tile
- WALL FINISHES LEGEND:**
- EWC Epoxy Wall Coating
  - HPC High Performance Coating
  - PT Paint
- CEILING FINISHES LEGEND:**
- ECC Epoxy Ceiling Coating
  - HPC High Performance Coating
  - PF Prefinished
  - PT Paint
- WALL PROTECTION LEGEND:**
- ESRP Extruded Semi-Rigid PVCu Panel
  - FRL Fibre Reinforced Laminate
  - FRP Fibreglass Reinforced Plastic
  - PVV Protective Vinyl Wallcovering
  - RHIS Rigid High Impact Sheet
  - WSSP Wetwall Solid Surface Panel
  - WVV Wetroom Vinyl Wallcovering
- FLOOR FINISHES LEGEND:**
- CFS Concrete Floor Sealer
  - EFC Epoxy Floor Coating
  - PFC Polyurethane Floor Coating
  - RAF Rubber Athletic Flooring
  - RSF Rubber Sheet Flooring
  - SCF Seamless Cushioned Flooring
  - SDRF Static-Dissipative Rubber Sheet Flooring
  - SDVF Static-Dissipative Vinyl Sheet Flooring
  - VSF Vinyl Sheet Flooring
  - WSVF Wetroom Safety Vinyl Sheet Flooring
- FLOOR BASE LEGEND:**
- FCB Flash Cove Base
  - RB Rubber Base
  - SCF Seamless Cushioned Flooring

**DOORS**

Types:

Type	Qty	Size (mm)	Material	Finish	Side Lt.	Blinds	Protect.	Privacy Film	Function	Card Reader	Mag Lock	Auto Opener	Hold Open	Hinges	Accessory 1	Accessory 2	Accessory 3	Closer
C	2	1220 x 2135	Solid Core	FRL	<input type="checkbox"/>	<input type="checkbox"/>	2 High	<input checked="" type="checkbox"/>	Storeroom	<input checked="" type="checkbox"/>	<input type="checkbox"/>	<input type="checkbox"/>	<input checked="" type="checkbox"/>	Cont. Swing Clear				Surface

Door Remarks:  Security Grille  Anti-barricade strategy



**MECHANICAL REQUIREMENTS**

<b>PLUMBING</b> (Quantity) Hand Hygiene Sink: <input type="text"/> Lavatory: <input type="text"/> Kitchen Sink: <input type="text"/> Seamless Kitchen Sink: <input type="text"/> Utility / Process Sink: <input type="text"/> Scrub Sink: <input type="text"/> Floor Sink: <input type="text"/> Plumbing Remarks: <input type="text"/>	Other Fixtures: <input type="checkbox"/> Shower <input type="checkbox"/> Eyewash Station <input type="checkbox"/> Tub <input type="checkbox"/> Eyewash/Shower Station <input type="checkbox"/> Ice Maker <input type="checkbox"/> Emergency Shower <input type="checkbox"/> Water Closet <input type="checkbox"/> Flush Rim Sink <input type="checkbox"/> Instantaneous Hot Water <input type="checkbox"/> Floor Drain <input type="checkbox"/> <input type="checkbox"/> Water Bottle Refill Station Other <input type="text"/>	<b>MED / NON-MED GASES</b> (Quantity) Oxygen: <input type="text"/> Medical Air: <input type="text"/> Medical Vacuum: <input type="text"/> Nitrous Oxide: <input type="text"/> CO2: <input type="text"/> AGSS: <input type="text"/> Nitrogen: <input type="text"/> Laboratory Air: <input type="text"/> Laboratory Vacuum: <input type="text"/> Utility Compressed Air: <input type="text"/> Gas Remarks: <input type="text"/>
---	--	---

**Appendix 1B Minimum Room Requirements**

Room Name:

Program Number(s):

1. T4.03	7.	13.	19.	25.	31.	37.	43.
2.	8.	14.	20.	26.	32.	38.	44.
3.	9.	15.	21.	27.	33.	39.	45.
4.	10.	16.	22.	28.	34.	40.	46.
5.	11.	17.	23.	29.	35.	41.	47.
6.	12.	18.	24.	30.	36.	42.	48.

**ARCHITECTURAL REQUIREMENTS**

<b>WALL AND CEILING</b> Wall Material: <input type="text" value="ARGB 1.2m AFF, GB above"/> Finish: <input type="text" value="PT"/> Ceiling Material: <input type="text" value="ACT"/> Finish: <input type="text" value="PF"/>	<b>WALL PROTECTION</b> Type: <input type="text" value="PVW"/> <input checked="" type="checkbox"/> Corner Guards <input type="checkbox"/> Hand Rails <input type="checkbox"/> Bed Bumper / Locator Height: <input type="text" value="1350 mm"/> <input type="checkbox"/> Crash Rails <input type="checkbox"/> Chair Rail	<b>GLAZING</b> <input type="checkbox"/> Interior Glazing	<b>FLOORING TYPES</b> Material: <input type="text" value="VSF"/> Base: <input type="text" value="FCB"/>	<b>ROOM ACCESSORIES</b> <input type="checkbox"/> Coat Hooks <input type="checkbox"/> Ceiling Lift <input type="checkbox"/> Magnetic Whiteboard <input type="checkbox"/> Mirror <input type="checkbox"/> Infant Change Table <input type="checkbox"/> Privacy Curtain
--	---	---	--	--

- LEGEND:**
- WALL AND CEILING LEGEND:**
- AC Architectural Ceiling
  - ACT Acoustic Ceiling Tile
  - ACT-C Cleanroom
  - ARGB Abuse-Resistant Gypsum Board
  - GB Gypsum Board
  - IRGB Impact-Resistant Gypsum Board
  - KLCT Kitchen Lay-in Ceiling Tile
  - MMRGB Moisture and Mould-Resistant Gypsum Board
  - SACT Security Acoustic Ceiling Tile
- WALL FINISHES LEGEND:**
- EWC Epoxy Wall Coating
  - HPC High Performance Coating
  - PT Paint
- CEILING FINISHES LEGEND:**
- ECC Epoxy Ceiling Coating
  - HPC High Performance Coating
  - PF Prefinished
  - PT Paint
- WALL PROTECTION LEGEND:**
- ESRP Extruded Semi-Rigid PVCu Panel
  - FRL Fibre Reinforced Laminate
  - FRP Fibreglass Reinforced Plastic
  - PVW Protective Vinyl Wallcovering
  - RHIS Rigid High Impact Sheet
  - WSSP Wetwall Solid Surface Panel
  - WVV Wetroom Vinyl Wallcovering
- FLOOR FINISHES LEGEND:**
- CFS Concrete Floor Sealer
  - EFC Epoxy Floor Coating
  - PFC Polyurethane Floor Coating
  - RAF Rubber Athletic Flooring
  - RSF Rubber Sheet Flooring
  - SCF Seamless Cushioned Flooring
  - SDRF Static-Dissipative Rubber Sheet Flooring
  - SDVF Static-Dissipative Vinyl Sheet Flooring
  - VSF Vinyl Sheet Flooring
  - WSVF Wetroom Safety Vinyl Sheet Flooring
- FLOOR BASE LEGEND:**
- FCB Flash Cove Base
  - RB Rubber Base
  - SCF Seamless Cushioned Flooring

**DOORS**

Types:

Note: for Type F doors, the door panels will be approximately 465/1065 unless otherwise required by the Authority

Type	Qty	Size (mm)	Material	Finish	Side Lt.	Blinds	Protect.	Privacy Film	Function	Card Reader	Mag Lock	Auto Opener	Hold Open	Hinges	Accessory 1	Accessory 2	Accessory 3	Closer
F2	1	1530 x 2135	Solid Core	FRL	<input type="checkbox"/>	<input type="checkbox"/>	2 High	<input checked="" type="checkbox"/>	Storeroom	<input checked="" type="checkbox"/>	<input type="checkbox"/>	<input type="checkbox"/>	<input type="checkbox"/>	Cont. Swing Clear	Astragal	Flush Bolt		Surface

**DOOR REMARKS:**

Security Grille  
 Anti-barricade strategy

**MILLWORK AND SPECIALTY CASEWORK**

Storage Requirements:

**UPPER UNITS:** U1, U2, U3, U4, U5, U6, U7, U8

**LOWER UNITS:** L1, L2, L3, L4, L5, L6, L7, L8, L9, L10, L11, L12

**RECEPTION/TRANSACTION COUNTER / CARE TEAM STATION DESK:** TC1, TC2

**UTILITY SINK AND COUNTER UNIT:** UC1

**SHELF:** S1

**FULL-HEIGHT CABINETS:** C1, C2, C3, C4, C5

**Legend:**

Category	Min. Length (mm)	Motorized Adjustable Height	Standing Height	Specialty Casework
Category 0 - None		<input type="checkbox"/>	<input type="checkbox"/>	<input type="checkbox"/>
Category 1 - Low (1% - 4%)		<input type="checkbox"/>	<input type="checkbox"/>	<input type="checkbox"/>
Category 2 - Med (5% - 9%)		<input type="checkbox"/>	<input type="checkbox"/>	<input type="checkbox"/>
Category 3 - High (10% or Greater)		<input type="checkbox"/>	<input type="checkbox"/>	<input type="checkbox"/>

**FINISHES**

Full-height Cabinet:   
 Upper Millwork:   
 Countertop:   
 Lower Millwork:   
 Shelf:

**REMARKS:**

**MECHANICAL REQUIREMENTS**

**PLUMBING**

Hand Hygiene Sink:	Lavatory:	Kitchen Sink:	Seamless Kitchen Sink:	Utility / Process Sink:	Scrub Sink:	Floor Sink:
<input type="text"/>	<input type="text"/>	<input type="text"/>	<input type="text"/>	<input type="text"/>	<input type="text"/>	<input type="text"/>

Plumbing Remarks:

**Other Fixtures:**

- Shower
- Tub
- Ice Maker
- Water Closet
- Instantaneous Hot Water
- Eyewash Station
- Eyewash/Shower Station
- Emergency Shower
- Flush Rim Sink
- Floor Drain
- Water Bottle Refill Station

Other:

**MED / NON-MED GASES**

Oxygen:	Medical Air:	Medical Vacuum:	Nitrous Oxide:	CO2:	AGSS:	Nitrogen:	Laboratory Air:	Laboratory Vacuum:	Utility Compressed Air:
<input type="text"/>	<input type="text"/>	<input type="text"/>	<input type="text"/>	<input type="text"/>	<input type="text"/>	<input type="text"/>	<input type="text"/>	<input type="text"/>	<input type="text"/>

Gas Remarks:



**Appendix 1B Minimum Room Requirements**

Room Name:

Program Number(s):

1. T1.01	7.	13.	19.	25.	31.	37.	43.
2.	8.	14.	20.	26.	32.	38.	44.
3.	9.	15.	21.	27.	33.	39.	45.
4.	10.	16.	22.	28.	34.	40.	46.
5.	11.	17.	23.	29.	35.	41.	47.
6.	12.	18.	24.	30.	36.	42.	48.

**ARCHITECTURAL REQUIREMENTS**

<b>WALL AND CEILING</b> Wall Material: <input type="text" value="GB"/> Finish: <input type="text" value="PT"/> Ceiling Material: <input type="text" value="ACT"/> Finish: <input type="text" value="PF"/>	<b>WALL PROTECTION</b> Type: <input type="text" value="PVW"/> <input checked="" type="checkbox"/> Corner Guards <input checked="" type="checkbox"/> Hand Rails <input type="checkbox"/> Bed Bumper / Locator Height: <input type="text" value="2185 mm"/> <input type="checkbox"/> Crash Rails <input type="checkbox"/> Chair Rail	<b>GLAZING</b> <input checked="" type="checkbox"/> Interior Glazing	<b>FLOORING TYPES</b> Material: <input type="text" value="VSF"/> Base: <input type="text" value="FCB"/>	<b>ROOM ACCESSORIES</b> <input type="checkbox"/> Coat Hooks <input type="checkbox"/> Ceiling Lift <input type="checkbox"/> Magnetic Whiteboard <input type="checkbox"/> Mirror <input type="checkbox"/> Infant Change Table <input type="checkbox"/> Privacy Curtain
---	--	--	--	--

- LEGEND:**
- WALL AND CEILING LEGEND:**
- AC Architectural Ceiling
  - ACT Acoustic Ceiling Tile
  - ACT-C Cleanroom
  - ARGB Abuse-Resistant Gypsum Board
  - GB Gypsum Board
  - IRGB Impact-Resistant Gypsum Board
  - KLCT Kitchen Lay-in Ceiling Tile
  - MMRGB Moisture and Mould-Resistant Gypsum Board
  - SACT Security Acoustic Ceiling Tile
- WALL FINISHES LEGEND:**
- EWC Epoxy Wall Coating
  - HPC High Performance Coating
  - PT Paint
- CEILING FINISHES LEGEND:**
- ECC Epoxy Ceiling Coating
  - HPC High Performance Coating
  - PF Prefinished
  - PT Paint
- WALL PROTECTION LEGEND:**
- ESRP Extruded Semi-Rigid PVCu Panel
  - FRL Fibre Reinforced Laminate
  - FRP Fibreglass Reinforced Plastic
  - PVW Protective Vinyl Wallcovering
  - RHIS Rigid High Impact Sheet
  - WSSP Wetwall Solid Surface Panel
  - WVV Wetroom Vinyl Wallcovering
- FLOOR FINISHES LEGEND:**
- CFS Concrete Floor Sealer
  - EFC Epoxy Floor Coating
  - PFC Polyurethane Floor Coating
  - RAF Rubber Athletic Flooring
  - RSF Rubber Sheet Flooring
  - SCF Seamless Cushioned Flooring
  - SDRF Static-Dissipative Rubber Sheet Flooring
  - SDVF Static-Dissipative Vinyl Sheet Flooring
  - VSF Vinyl Sheet Flooring
  - WSVF Wetroom Safety Vinyl Sheet Flooring
- FLOOR BASE LEGEND:**
- FCB Flash Cove Base
  - RB Rubber Base
  - SCF Seamless Cushioned Flooring

**DOORS**

Types:

Type	Qty	Size (mm)	Material	Finish	Side Lt.	Blinds	Protect.	Privacy Film	Function	Card Reader	Mag Lock	Auto Opener	Hold Open	Hinges	Accessory 1	Accessory 2	Accessory 3	Closer
E2	2	1830 x 2135	Aluminum	Prefinished	<input type="checkbox"/>	<input type="checkbox"/>		<input checked="" type="checkbox"/>	Storeroom	<input checked="" type="checkbox"/>	<input type="checkbox"/>	<input checked="" type="checkbox"/>	<input checked="" type="checkbox"/>	Butt Hinge	Astragal	Flush Bolt	Elec. Strike	Surface

Door Remarks:  Security Grille  Anti-barricade strategy



**MECHANICAL REQUIREMENTS**

<b>PLUMBING</b> (Quantity) Hand Hygiene Sink: <input type="text"/> Lavatory: <input type="text"/> Kitchen Sink: <input type="text"/> Seamless Kitchen Sink: <input type="text"/> Utility / Process Sink: <input type="text"/> Scrub Sink: <input type="text"/> Floor Sink: <input type="text"/> Plumbing Remarks: <input type="text"/>	Other Fixtures: <input type="checkbox"/> Shower <input type="checkbox"/> Eyewash Station <input type="checkbox"/> Tub <input type="checkbox"/> Eyewash/Shower Station <input type="checkbox"/> Ice Maker <input type="checkbox"/> Emergency Shower <input type="checkbox"/> Water Closet <input checked="" type="checkbox"/> Floor Drain <input type="checkbox"/> Instantaneous Hot Water <input type="checkbox"/> Water Bottle Refill Station Other: <input type="text"/>	<b>MED / NON-MED GASES</b> (Quantity) Oxygen: <input type="text"/> Medical Air: <input type="text"/> Medical Vacuum: <input type="text"/> Nitrous Oxide: <input type="text"/> CO2: <input type="text"/> AGSS: <input type="text"/> Nitrogen: <input type="text"/> Laboratory Air: <input type="text"/> Laboratory Vacuum: <input type="text"/> Utility Compressed Air: <input type="text"/> Gas Remarks: <input type="text"/>
---	--	---

**Appendix 1B Minimum Room Requirements**

Room Name:

Program Number(s):

1. T4.01	7.	13.	19.	25.	31.	37.	43.
2.	8.	14.	20.	26.	32.	38.	44.
3.	9.	15.	21.	27.	33.	39.	45.
4.	10.	16.	22.	28.	34.	40.	46.
5.	11.	17.	23.	29.	35.	41.	47.
6.	12.	18.	24.	30.	36.	42.	48.

**ARCHITECTURAL REQUIREMENTS**

<b>WALL AND CEILING</b> Wall Material: <input type="text" value="ARGB 1.2m AFF, GB above"/> Finish: <input type="text" value="PT"/> Ceiling Material: <input type="text" value="ACT"/> Finish: <input type="text" value="PF"/>	<b>WALL PROTECTION</b> Type: <input type="text" value="PVW"/> <input checked="" type="checkbox"/> Corner Guards <input type="checkbox"/> Hand Rails <input type="checkbox"/> Bed Bumper / Locator Height: <input type="text" value="1350 mm"/> <input type="checkbox"/> Crash Rails <input type="checkbox"/> Chair Rail	<b>GLAZING</b> <input checked="" type="checkbox"/> Interior Glazing	<b>FLOORING TYPES</b> Material: <input type="text" value="VSF"/> Base: <input type="text" value="FCB"/>	<b>ROOM ACCESSORIES</b> <input checked="" type="checkbox"/> Coat Hooks <input type="checkbox"/> Ceiling Lift <input type="checkbox"/> Magnetic Whiteboard <input type="checkbox"/> Mirror <input type="checkbox"/> Infant Change Table <input type="checkbox"/> Privacy Curtain
--	---	--	--	---

- LEGEND:**
- WALL AND CEILING LEGEND:**
- AC Architectural Ceiling
  - ACT Acoustic Ceiling Tile
  - ACT-C Cleanroom
  - ARGB Abuse-Resistant Gypsum Board
  - GB Gypsum Board
  - IRGB Impact-Resistant Gypsum Board
  - KLCT Kitchen Lay-in Ceiling Tile
  - MMRGB Moisture and Mould-Resistant Gypsum Board
  - SACT Security Acoustic Ceiling Tile
- WALL FINISHES LEGEND:**
- EWC Epoxy Wall Coating
  - HPC High Performance Coating
  - PT Paint
- CEILING FINISHES LEGEND:**
- ECC Epoxy Ceiling Coating
  - HPC High Performance Coating
  - PF Prefinished
  - PT Paint
- WALL PROTECTION LEGEND:**
- ESRP Extruded Semi-Rigid PVCu Panel
  - FRL Fibre Reinforced Laminate
  - FRP Fibreglass Reinforced Plastic
  - PVW Protective Vinyl Wallcovering
  - RHIS Rigid High Impact Sheet
  - WSSP Wetwall Solid Surface Panel
  - WVV Wetroom Vinyl Wallcovering
- FLOOR FINISHES LEGEND:**
- CFS Concrete Floor Sealer
  - EFC Epoxy Floor Coating
  - PFC Polyurethane Floor Coating
  - RAF Rubber Athletic Flooring
  - RSF Rubber Sheet Flooring
  - SCF Seamless Cushioned Flooring
  - SDRF Static-Dissipative Rubber Sheet Flooring
  - SDVF Static-Dissipative Vinyl Sheet Flooring
  - VSF Vinyl Sheet Flooring
  - WSVF Wetroom Safety Vinyl Sheet Flooring
- FLOOR BASE LEGEND:**
- FCB Flash Cove Base
  - RB Rubber Base
  - SCF Seamless Cushioned Flooring

**DOORS**

Types:

Type	Qty	Size (mm)	Material	Finish	Side Lt.	Blinds	Protect.	Privacy Film	Function	Card Reader	Mag Lock	Auto Opener	Hold Open	Hinges	Accessory 1	Accessory 2	Accessory 3	Closer
E2	2	1830 x 2135	Solid Core	FRL	<input type="checkbox"/>	<input checked="" type="checkbox"/>	1 Low	<input checked="" type="checkbox"/>	Storeroom	<input checked="" type="checkbox"/>	<input type="checkbox"/>	<input type="checkbox"/>	<input checked="" type="checkbox"/>	Butt Hinge	Astragal	Flush Bolt		Surface

Door Remarks:  Security Grille  Anti-barricade strategy

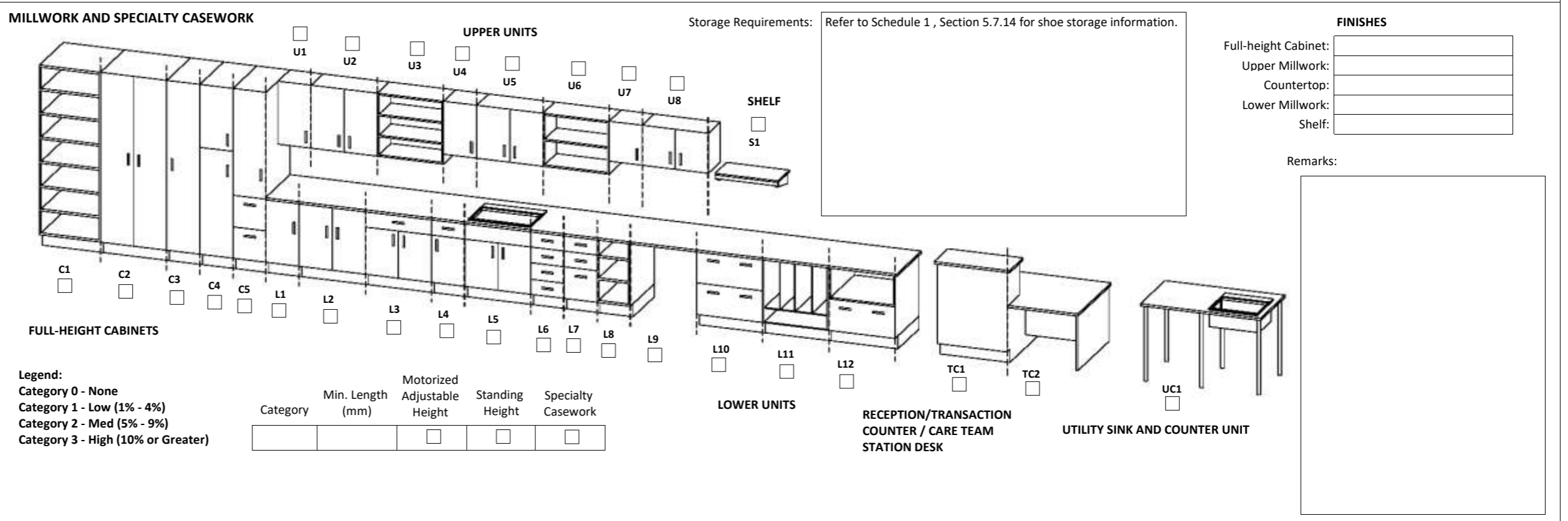

**MECHANICAL REQUIREMENTS**

<b>PLUMBING</b> (Quantity) Hand Hygiene Sink: <input type="text" value="1"/> Lavatory: <input type="text"/> Kitchen Sink: <input type="text"/> Seamless Kitchen Sink: <input type="text"/> Utility / Process Sink: <input type="text"/> Scrub Sink: <input type="text"/> Floor Sink: <input type="text"/> Plumbing Remarks: <input type="text"/>	Other Fixtures: <input type="checkbox"/> Shower <input type="checkbox"/> Tub <input type="checkbox"/> Ice Maker <input type="checkbox"/> Water Closet <input type="checkbox"/> Instantaneous Hot Water <input type="checkbox"/> Eyewash Station <input type="checkbox"/> Eyewash/Shower Station <input type="checkbox"/> Emergency Shower <input type="checkbox"/> Flush Rim Sink <input type="checkbox"/> Floor Drain <input type="checkbox"/> Water Bottle Refill Station Other: <input type="text"/>	<b>MED / NON-MED GASES</b> (Quantity) Oxygen: <input type="text"/> Medical Air: <input type="text"/> Medical Vacuum: <input type="text"/> Nitrous Oxide: <input type="text"/> CO2: <input type="text"/> AGSS: <input type="text"/> Nitrogen: <input type="text"/> Laboratory Air: <input type="text"/> Laboratory Vacuum: <input type="text"/> Utility Compressed Air: <input type="text"/> Gas Remarks: <input type="text"/>
---	--	---

# Appendix 1B Minimum Room Requirements

Room Name:

Program Number(s):

1.	T1.05	7.		13.		19.		25.		31.		37.		43.
2.		8.		14.		20.		26.		32.		38.		44.
3.		9.		15.		21.		27.		33.		39.		45.
4.		10.		16.		22.		28.		34.		40.		46.
5.		11.		17.		23.		29.		35.		41.		47.
6.		12.		18.		24.		30.		36.		42.		48.

## ARCHITECTURAL REQUIREMENTS

<b>WALL AND CEILING</b> Wall Material: <input type="text" value="ARGB 1.2m AFF, GB above"/> Finish: <input type="text" value="PT"/> Ceiling Material: <input type="text" value="ACT"/> Finish: <input type="text" value="PF"/>		<b>WALL PROTECTION</b> Type: <input type="text" value="PVW"/> <input checked="" type="checkbox"/> Corner Guards <input type="checkbox"/> Hand Rails <input type="checkbox"/> Bed Bumper / Locator Height: <input type="text" value="1350 mm"/> <input type="checkbox"/> Crash Rails <input checked="" type="checkbox"/> Chair Rail			<b>GLAZING</b> <input type="checkbox"/> Interior Glazing		<b>FLOORING TYPES</b> Material: <input type="text" value="VSF"/> Base: <input type="text" value="FCB"/>		<b>ROOM ACCESSORIES</b> <input checked="" type="checkbox"/> Coat Hooks <input type="checkbox"/> Ceiling Lift <input checked="" type="checkbox"/> Magnetic Whiteboard <input type="checkbox"/> Mirror <input type="checkbox"/> Infant Change Table <input type="checkbox"/> Privacy Curtain		
--	--	--	--	--	---	--	--	--	--	--	--

- LEGEND:**
- WALL AND CEILING LEGEND:**
- AC Architectural Ceiling
  - ACT Acoustic Ceiling Tile
  - ACT-C Cleanroom
  - ARGB Abuse-Resistant Gypsum Board
  - GB Gypsum Board
  - IRGB Impact-Resistant Gypsum Board
  - KLCT Kitchen Lay-in Ceiling Tile
  - MMRGB Moisture and Mould-Resistant Gypsum Board
  - SACT Security Acoustic Ceiling Tile
- WALL FINISHES LEGEND:**
- EWC Epoxy Wall Coating
  - HPC High Performance Coating
  - PT Paint
- CEILING FINISHES LEGEND:**
- ECC Epoxy Ceiling Coating
  - HPC High Performance Coating
  - PF Prefinished
  - PT Paint
- WALL PROTECTION LEGEND:**
- ESRP Extruded Semi-Rigid PVCu Panel
  - FRL Fibre Reinforced Laminated
  - FRP Fibreglass Reinforced Plastic
  - PVW Protective Vinyl Wallcovering
  - RHIS Rigid High Impact Sheet
  - WSSP Wetwall Solid Surface Panel
  - WVV Wetroom Vinyl Wallcovering
- FLOOR FINISHES LEGEND:**
- CFS Concrete Floor Sealer
  - EFC Epoxy Floor Coating
  - PFC Polyurethane Floor Coating
  - RAF Rubber Athletic Flooring
  - RSF Rubber Sheet Flooring
  - SCF Seamless Cushioned Flooring
  - SDRF Static-Dissipative Rubber Sheet Flooring
  - SDVF Static-Dissipative Vinyl Sheet Flooring
  - VSF Vinyl Sheet Flooring
  - WSVF Wetroom Safety Vinyl Sheet Flooring
- FLOOR BASE LEGEND:**
- FCB Flash Cove Base
  - RB Rubber Base
  - SCF Seamless Cushioned Flooring

**DOORS**

Types:

Type	Qty	Size (mm)	Material	Finish	Side Lt.	Blinds	Protect.	Privacy Film	Function	Card Reader	Mag Lock	Auto Opener	Hold Open	Hinges	Accessory 1	Accessory 2	Accessory 3	Closer
B	1	1650 x 2135	Solid Core	FRL	<input type="checkbox"/>	<input type="checkbox"/>	1 Low	<input checked="" type="checkbox"/>	Storeroom	<input checked="" type="checkbox"/>	<input type="checkbox"/>	<input type="checkbox"/>	<input checked="" type="checkbox"/>	Butt Hinge				Surface

Door Remarks:  Security Grille  Anti-barricade strategy

**MILLWORK AND SPECIALTY CASEWORK**

Storage Requirements: Provide (12) half lockers.

**UPPER UNITS** (U1-U8)

**LOWER UNITS** (L1-L12)

**RECEPTION/TRANSACTION COUNTER / CARE TEAM STATION DESK** (TC1, TC2)

**UTILITY SINK AND COUNTER UNIT** (UC1)

**FINISHES**

Full-height Cabinet:	Plastic Laminate
Upper Millwork:	Plastic Laminate
Countertop:	Solid Surfacing
Lower Millwork:	Plastic Laminate
Shelf:	

Remarks:

## MECHANICAL REQUIREMENTS

**PLUMBING**

Hand Hygiene Sink: <input type="text" value="1"/>	Lavatory: <input type="text"/>	Kitchen Sink: <input type="text"/>	Seamless Kitchen Sink: <input type="text"/>	Utility / Process Sink: <input type="text"/>	Scrub Sink: <input type="text"/>	Floor Sink: <input type="text"/>
---	--------------------------------	------------------------------------	---	--	----------------------------------	----------------------------------

Plumbing Remarks:

**Other Fixtures:**

- Shower
- Tub
- Ice Maker
- Water Closet
- Instantaneous Hot Water
- Ewewash Station
- Eyewash/Shower Station
- Emergency Shower
- Flush Rim Sink
- Floor Drain
- Water Bottle Refill Station

Other:

**MED / NON-MED GASES**

Oxygen:	Medical Air:	Medical Vacuum:	Nitrous Oxide:	CO2:	AGSS:	Nitrogen:	Laboratory Air:	Laboratory Vacuum:	Utility Compressed Air:
<input type="text"/>	<input type="text"/>	<input type="text"/>	<input type="text"/>	<input type="text"/>	<input type="text"/>	<input type="text"/>	<input type="text"/>	<input type="text"/>	<input type="text"/>

Gas Remarks:



---

# New Surrey Hospital & BC Cancer Centre

MINIMUM ROOM REQUIREMENTS

## U. Administration

---

# Appendix 1B Minimum Room Requirements

Room Name: Meeting Room - EOC

Program Number(s):

1. U6.04	7.	13.	19.	25.	31.	37.	43.
2.	8.	14.	20.	26.	32.	38.	44.
3.	9.	15.	21.	27.	33.	39.	45.
4.	10.	16.	22.	28.	34.	40.	46.
5.	11.	17.	23.	29.	35.	41.	47.
6.	12.	18.	24.	30.	36.	42.	48.

## ARCHITECTURAL REQUIREMENTS

<b>WALL AND CEILING</b> Wall Material: <input type="text" value="GB"/> Finish: <input type="text" value="PT"/> Ceiling Material: <input type="text" value="ACT"/> Finish: <input type="text" value="PF"/>	<b>WALL PROTECTION</b> Type: <input type="text" value="PVW"/> <input checked="" type="checkbox"/> Corner Guards <input type="checkbox"/> Hand Rails <input type="checkbox"/> Bed Bumper / Locator Height: <input type="text" value="1350 mm"/> <input type="checkbox"/> Crash Rails <input checked="" type="checkbox"/> Chair Rail	<b>GLAZING</b> <input type="checkbox"/> Interior Glazing	<b>FLOORING TYPES</b> Material: <input type="text" value="RSF"/> Base: <input type="text" value="RB"/>	<b>ROOM ACCESSORIES</b> <input checked="" type="checkbox"/> Coat Hooks <input type="checkbox"/> Ceiling Lift <input checked="" type="checkbox"/> Magnetic Whiteboard <input type="checkbox"/> Mirror <input type="checkbox"/> Infant Change Table <input type="checkbox"/> Privacy Curtain
---	--	---	---	--

- LEGEND:**
- WALL AND CEILING LEGEND:**
- AC Architectural Ceiling
  - ACT Acoustic Ceiling Tile
  - ACT-C Cleanroom
  - ARGB Abuse-Resistant Gypsum Board
  - GB Gypsum Board
  - IRGB Impact-Resistant Gypsum Board
  - KLCT Kitchen Lay-in Ceiling Tile
  - MMRGB Moisture and Mould-Resistant Gypsum Board
  - SACT Security Acoustic Ceiling Tile
- WALL FINISHES LEGEND:**
- EWC Epoxy Wall Coating
  - HPC High Performance Coating
  - PT Paint
- CEILING FINISHES LEGEND:**
- ECC Epoxy Ceiling Coating
  - HPC High Performance Coating
  - PF Prefinished
  - PT Paint
- WALL PROTECTION LEGEND:**
- ESRP Extruded Semi-Rigid PVCu Panel
  - FRL Fibre Reinforced Laminate
  - FRP Fibreglass Reinforced Plastic
  - PVW Protective Vinyl Wallcovering
  - RHIS Rigid High Impact Sheet
  - WSSP Wetwall Solid Surface Panel
  - WVV Wetroom Vinyl Wallcovering
- FLOOR FINISHES LEGEND:**
- CFS Concrete Floor Sealer
  - EFC Epoxy Floor Coating
  - PFC Polyurethane Floor Coating
  - RAF Rubber Athletic Flooring
  - RSF Rubber Sheet Flooring
  - SCF Seamless Cushioned Flooring
  - SDRF Static-Dissipative Rubber Sheet Flooring
  - SDVF Static-Dissipative Vinyl Sheet Flooring
  - VSF Vinyl Sheet Flooring
  - WSVF Wetroom Safety Vinyl Sheet Flooring
- FLOOR BASE LEGEND:**
- FCB Flash Cove Base
  - RB Rubber Base
  - SCF Seamless Cushioned Flooring

**DOORS**

Types:

Type	Qty	Size (mm)	Material	Finish	Side Lt.	Blinds	Protect.	Film	Function	Card Reader	Mag Lock	Auto Opener	Hold Open	Hinges	Accessory 1	Accessory 2	Accessory 3	Closer
C	1	915 x 2135	Solid Core	FRL	<input type="checkbox"/>	<input type="checkbox"/>	1 Low	<input type="checkbox"/>	Storeroom	<input checked="" type="checkbox"/>	<input type="checkbox"/>	<input type="checkbox"/>	<input type="checkbox"/>	Butt Hinge				Surface

Door Remarks:  Security Grille  Anti-barricade strategy

**MILLWORK AND SPECIALTY CASEWORK**

Storage Requirements:

**UPPER UNITS** (U1-U8)

**LOWER UNITS** (L1-L9)

**RECEPTION/TRANSACTION COUNTER / CARE TEAM STATION DESK** (TC1, TC2)

**UTILITY SINK AND COUNTER UNIT** (UC1)

**SHELF** (S1)

**FULL-HEIGHT CABINETS** (C1-C5)

**Legend:**

Category	Min. Length (mm)	Motorized Adjustable Height	Standing Height	Specialty Casework
2	3900	<input type="checkbox"/>	<input type="checkbox"/>	<input type="checkbox"/>

**FINISHES**

- Full-height Cabinet: Plastic Laminate
- Upper Millwork: Plastic Laminate
- Countertop: Plastic Laminate
- Lower Millwork: Plastic Laminate
- Shelf:

Remarks:

## MECHANICAL REQUIREMENTS

**PLUMBING**

Hand Hygiene Sink:	Lavatory:	Kitchen Sink:	Seamless Kitchen Sink:	Utility / Process Sink:	Scrub Sink:	Floor Sink:
<input type="text"/>	<input type="text"/>	<input type="text"/>	<input type="text"/>	<input type="text"/>	<input type="text"/>	<input type="text"/>

Plumbing Remarks:

**Other Fixtures:**

- Shower
- Tub
- Ice Maker
- Water Closet
- Instantaneous Hot Water
- Eyewash Station
- Eyewash/Shower Station
- Emergency Shower
- Flush Rim Sink
- Floor Drain
- Water Bottle Refill Station
- Other:

**MED / NON-MED GASES**

Oxygen:	Medical Air:	Medical Vacuum:	Nitrous Oxide:	CO2:	AGSS:	Nitrogen:	Laboratory Air:	Laboratory Vacuum:	Utility Compressed Air:
<input type="text"/>	<input type="text"/>	<input type="text"/>	<input type="text"/>	<input type="text"/>	<input type="text"/>	<input type="text"/>	<input type="text"/>	<input type="text"/>	<input type="text"/>

Gas Remarks:

**Appendix 1B Minimum Room Requirements**

Room Name:

Program Number(s):	1. U1.01	7.	13.	19.	25.	31.	37.	43.
	2.	8.	14.	20.	26.	32.	38.	44.
	3.	9.	15.	21.	27.	33.	39.	45.
	4.	10.	16.	22.	28.	34.	40.	46.
	5.	11.	17.	23.	29.	35.	41.	47.
	6.	12.	18.	24.	30.	36.	42.	48.

**ARCHITECTURAL REQUIREMENTS**

<b>WALL AND CEILING</b> Wall Material: <input type="text" value="ARGB 1.2m AFF, GB above"/> Finish: <input type="text" value="PT"/> Ceiling Material: <input type="text" value="ACT"/> Finish: <input type="text" value="PF"/>		<b>WALL PROTECTION</b> Type: <input type="text"/> Height: <input type="text"/> <input type="checkbox"/> Corner Guards <input type="checkbox"/> Hand Rails <input type="checkbox"/> Bed Bumper / Locator <input type="checkbox"/> Crash Rails <input checked="" type="checkbox"/> Chair Rail		<b>GLAZING</b> <input checked="" type="checkbox"/> Interior Glazing		<b>FLOORING TYPES</b> Material: <input type="text" value="VSF"/> Base: <input type="text" value="FCB"/>		<b>ROOM ACCESSORIES</b> <input checked="" type="checkbox"/> Coat Hooks <input type="checkbox"/> Ceiling Lift <input type="checkbox"/> Magnetic Whiteboard <input type="checkbox"/> Mirror <input type="checkbox"/> Infant Change Table <input type="checkbox"/> Privacy Curtain	
--	--	--	--	--	--	--	--	---	--

- LEGEND:**
- WALL AND CEILING LEGEND:**
- AC Architectural Ceiling
  - ACT Acoustic Ceiling Tile
  - ACT-C Cleanroom
  - ARGB Abuse-Resistant Gypsum Board
  - GB Gypsum Board
  - IRGB Impact-Resistant Gypsum Board
  - KLCT Kitchen Lay-in Ceiling Tile
  - MMRGB Moisture and Mould-Resistant Gypsum Board
  - SACT Security Acoustic Ceiling Tile
- WALL FINISHES LEGEND:**
- EWC Epoxy Wall Coating
  - HPC High Performance Coating
  - PT Paint
- CEILING FINISHES LEGEND:**
- ECC Epoxy Ceiling Coating
  - HPC High Performance Coating
  - PF Prefinished
  - PT Paint
- WALL PROTECTION LEGEND:**
- ESRP Extruded Semi-Rigid PVCu Panel
  - FRL Fibre Reinforced Laminiate
  - FRP Fibreglass Reinforced Plastic
  - PVV Protective Vinyl Wallcovering
  - RHIS Rigid High Impact Sheet
  - WSSP Wetwall Solid Surface Panel
  - WVV Wetroom Vinyl Wallcovering
- FLOOR FINISHES LEGEND:**
- CFS Concrete Floor Sealer
  - EFC Epoxy Floor Coating
  - PFC Polyurethane Floor Coating
  - RAF Rubber Athletic Flooring
  - RSF Rubber Sheet Flooring
  - SCF Seamless Cushioned Flooring
  - SDRF Static-Dissipative Rubber Sheet Flooring
  - SDVF Static-Dissipative Vinyl Sheet Flooring
  - VSF Vinyl Sheet Flooring
  - WSVF Wetroom Safety Vinyl Sheet Flooring
- FLOOR BASE LEGEND:**
- FCB Flash Cove Base
  - RB Rubber Base
  - SCF Seamless Cushioned Flooring

**DOORS**

Types:

Type	Qty	Size (mm)	Material	Finish	Side Lt.	Blinds	Protect.	Privacy Film	Function	Card Reader	Mag Lock	Auto Opener	Hold Open	Hinges	Accessory 1	Accessory 2	Accessory 3	Closer
C	1	915 x 2135	Solid Core	FRL	<input type="checkbox"/>	<input type="checkbox"/>	1 Low	<input checked="" type="checkbox"/>	Storeroom	<input checked="" type="checkbox"/>	<input type="checkbox"/>	<input type="checkbox"/>	<input type="checkbox"/>	Butt Hinge				Surface

**Door Remarks:**  
To provide a card reader access from both Public and Staff areas.

Security Grille  
 Anti-barricade strategy

**MILLWORK AND SPECIALTY CASEWORK**

Storage Requirements:

**UPPER UNITS:** U1, U2, U3, U4, U5, U6, U7, U8

**LOWER UNITS:** L1, L2, L3, L4, L5, L6, L7, L8, L9, L10, L11, L12

**RECEPTION/TRANSACTION COUNTER / CARE TEAM STATION DESK:** TC1, TC2

**UTILITY SINK AND COUNTER UNIT:** UC1

**SHELF:** S1

**FULL-HEIGHT CABINETS:** C1, C2, C3, C4, C5

**Legend:**

Category	Min. Length (mm)	Motorized Adjustable Height	Standing Height	Specialty Casework
3	4800	<input checked="" type="checkbox"/>	<input type="checkbox"/>	<input checked="" type="checkbox"/>

**FINISHES**

Full-height Cabinet:   
 Upper Millwork:   
 Countertop:   
 Lower Millwork:   
 Shelf:

**Remarks:**  
Refer to Schedule 1, Section 6.12 (Division 12) for Specialty Casework. Items indicated are diagrammatic, provide specialty casework appropriate for the specific and specialized functions to be performed in the space and to accommodate Equipment. Refer to Appendix 1A, Section 2.21 U. Administration for reception requirements

**MECHANICAL REQUIREMENTS**

<b>PLUMBING</b> (Quantity) Hand Hygiene Sink: <input type="text"/> Lavatory: <input type="text"/> Kitchen Sink: <input type="text"/> Seamless Kitchen Sink: <input type="text"/> Utility / Process Sink: <input type="text"/> Scrub Sink: <input type="text"/> Floor Sink: <input type="text"/>							Other Fixtures: <input type="checkbox"/> Shower <input type="checkbox"/> Eyewash Station <input type="checkbox"/> Tub <input type="checkbox"/> Eyewash/Shower Station <input type="checkbox"/> Ice Maker <input type="checkbox"/> Emergency Shower <input type="checkbox"/> Water Closet <input type="checkbox"/> Flush Rim Sink <input type="checkbox"/> Instantaneous Hot Water <input type="checkbox"/> Floor Drain <input type="checkbox"/> Water Bottle Refill Station Other: <input type="text"/>				<b>MED / NON-MED GASES</b> (Quantity) Oxygen: <input type="text"/> Medical Air: <input type="text"/> Medical Vacuum: <input type="text"/> Nitrous Oxide: <input type="text"/> CO2: <input type="text"/> AGSS: <input type="text"/> Nitrogen: <input type="text"/> Laboratory Air: <input type="text"/> Laboratory Vacuum: <input type="text"/> Utility Compressed Air: <input type="text"/>					
Plumbing Remarks: <input type="text"/>											Gas Remarks: <input type="text"/>					



**Appendix 1B Minimum Room Requirements**

Room Name:

Program Number(s):

1. U1.04	7.	13.	19.	25.	31.	37.	43.
2.	8.	14.	20.	26.	32.	38.	44.
3.	9.	15.	21.	27.	33.	39.	45.
4.	10.	16.	22.	28.	34.	40.	46.
5.	11.	17.	23.	29.	35.	41.	47.
6.	12.	18.	24.	30.	36.	42.	48.

**ARCHITECTURAL REQUIREMENTS**

<b>WALL AND CEILING</b> Wall Material: <input type="text" value="ARGB 1.2m AFF, GB above"/> Finish: <input type="text" value="PT"/> Ceiling Material: <input type="text" value="ACT"/> Finish: <input type="text" value="PF"/>	<b>WALL PROTECTION</b> Type: <input type="text"/> Height: <input type="text"/> <input type="checkbox"/> Corner Guards <input type="checkbox"/> Hand Rails <input type="checkbox"/> Bed Bumper / Locator <input type="checkbox"/> Crash Rails <input checked="" type="checkbox"/> Chair Rail	<b>GLAZING</b> <input checked="" type="checkbox"/> Interior Glazing	<b>FLOORING TYPES</b> Material: <input type="text" value="VSF"/> Base: <input type="text" value="FCB"/>	<b>ROOM ACCESSORIES</b> <input checked="" type="checkbox"/> Coat Hooks <input type="checkbox"/> Ceiling Lift <input checked="" type="checkbox"/> Magnetic Whiteboard <input type="checkbox"/> Mirror <input type="checkbox"/> Infant Change Table <input type="checkbox"/> Privacy Curtain
--	--	--	--	--

- LEGEND:**
- WALL AND CEILING LEGEND:**
- AC Architectural Ceiling
  - ACT Acoustic Ceiling Tile
  - ACT-C Cleanroom
  - ARGB Abuse-Resistant Gypsum Board
  - GB Gypsum Board
  - IRGB Impact-Resistant Gypsum Board
  - KLCT Kitchen Lay-in Ceiling Tile
  - MMRGB Moisture and Mould-Resistant Gypsum Board
  - SACT Security Acoustic Ceiling Tile
- WALL FINISHES LEGEND:**
- EWC Epoxy Wall Coating
  - HPC High Performance Coating
  - PT Paint
- CEILING FINISHES LEGEND:**
- ECC Epoxy Ceiling Coating
  - HPC High Performance Coating
  - PF Prefinished
  - PT Paint
- WALL PROTECTION LEGEND:**
- ESRP Extruded Semi-Rigid PVCu Panel
  - FRL Fibre Reinforced Laminata
  - FRP Fibreglass Reinforced Plastic
  - PVV Protective Vinyl Wallcovering
  - RHIS Rigid High Impact Sheet
  - WSSP Wetwall Solid Surface Panel
  - WWW Wetroom Vinyl Wallcovering
- FLOOR FINISHES LEGEND:**
- CFS Concrete Floor Sealer
  - EFC Epoxy Floor Coating
  - PFC Polyurethane Floor Coating
  - RAF Rubber Athletic Flooring
  - RSF Rubber Sheet Flooring
  - SCF Seamless Cushioned Flooring
  - SDRF Static-Dissipative Rubber Sheet Flooring
  - SDVF Static-Dissipative Vinyl Sheet Flooring
  - VSF Vinyl Sheet Flooring
  - WSVF Wetroom Safety Vinyl Sheet Flooring
- FLOOR BASE LEGEND:**
- FCB Flash Cove Base
  - RB Rubber Base
  - SCF Seamless Cushioned Flooring

**DOORS**

Types:

Type	Qty	Size (mm)	Material	Finish	Side Lt.	Blinds	Protect.	Privacy Film	Function	Card Reader	Mag Lock	Auto Opener	Hold Open	Hinges	Accessory 1	Accessory 2	Accessory 3	Closer
C	1	915 x 2135	Solid Core	FRL	<input type="checkbox"/>	<input type="checkbox"/>	1 Low	<input checked="" type="checkbox"/>	Storeroom	<input checked="" type="checkbox"/>	<input type="checkbox"/>	<input type="checkbox"/>	<input type="checkbox"/>	Butt Hinge				Surface

Door Remarks:  Security Grille  Anti-barricade strategy

**MILLWORK AND SPECIALTY CASEWORK**

Storage Requirements:

**UPPER UNITS** (U1-U8) **SHELF** (S1)

**FULL-HEIGHT CABINETS** (C1-C5) **LOWER UNITS** (L1-L12) **RECEPTION/TRANSACTION COUNTER / CARE TEAM STATION DESK** (TC1, TC2) **UTILITY SINK AND COUNTER UNIT** (UC1)

Category	Min. Length (mm)	Motorized Adjustable Height	Standing Height	Specialty Casework
3	3900	<input checked="" type="checkbox"/>	<input type="checkbox"/>	<input checked="" type="checkbox"/>

**FINISHES**

Full-height Cabinet:   
 Upper Millwork:   
 Countertop:   
 Lower Millwork:   
 Shelf:

Remarks: Refer to Schedule 1, Section 6.12 (Division 12) for Specialty Casework. Items indicated are diagrammatic, provide specialty casework appropriate for the specific and specialized functions to be performed in the space and to accommodate Equipment. Refer to Appendix 1A, Section 2.21 U. Administration for reception requirements

**MECHANICAL REQUIREMENTS**

<b>PLUMBING</b> (Quantity) Hand Hygiene Sink: <input type="text"/> Lavatory: <input type="text"/> Kitchen Sink: <input type="text"/> Seamless Kitchen Sink: <input type="text"/> Utility / Process Sink: <input type="text"/> Scrub Sink: <input type="text"/> Floor Sink: <input type="text"/> Plumbing Remarks: <input type="text"/>	Other Fixtures: <input type="checkbox"/> Shower <input type="checkbox"/> Tub <input type="checkbox"/> Ice Maker <input type="checkbox"/> Water Closet <input type="checkbox"/> Instantaneous Hot Water <input type="checkbox"/> Eyewash Station <input type="checkbox"/> Eyewash/Shower Station <input type="checkbox"/> Emergency Shower <input type="checkbox"/> Flush Rim Sink <input type="checkbox"/> Floor Drain <input type="checkbox"/> Water Bottle Refill Station Other: <input type="text"/>	<b>MED / NON-MED GASES</b> (Quantity) Oxygen: <input type="text"/> Medical Air: <input type="text"/> Medical Vacuum: <input type="text"/> Nitrous Oxide: <input type="text"/> CO2: <input type="text"/> AGSS: <input type="text"/> Nitrogen: <input type="text"/> Laboratory Air: <input type="text"/> Laboratory Vacuum: <input type="text"/> Utility Compressed Air: <input type="text"/> Gas Remarks: <input type="text"/>
--	--	---

**Appendix 1B Minimum Room Requirements**

Room Name:

Program Number(s):

1. U5.08	7.	13.	19.	25.	31.	37.	43.
2.	8.	14.	20.	26.	32.	38.	44.
3.	9.	15.	21.	27.	33.	39.	45.
4.	10.	16.	22.	28.	34.	40.	46.
5.	11.	17.	23.	29.	35.	41.	47.
6.	12.	18.	24.	30.	36.	42.	48.

**ARCHITECTURAL REQUIREMENTS**

<b>WALL AND CEILING</b> Wall Material: <input type="text" value="GB"/> Finish: <input type="text" value="PT"/> Ceiling Material: <input type="text" value="ACT"/> Finish: <input type="text" value="PF"/>	<b>WALL PROTECTION</b> Type: <input type="text" value="PVW"/> <input checked="" type="checkbox"/> Corner Guards <input type="checkbox"/> Hand Rails <input type="checkbox"/> Bed Bumper / Locator Height: <input type="text" value="1350 mm"/> <input type="checkbox"/> Crash Rails <input type="checkbox"/> Chair Rail	<b>GLAZING</b> <input type="checkbox"/> Interior Glazing	<b>FLOORING TYPES</b> Material: <input type="text" value="VSF"/> Base: <input type="text" value="FCB"/>	<b>ROOM ACCESSORIES</b> <input checked="" type="checkbox"/> Coat Hooks <input type="checkbox"/> Ceiling Lift <input checked="" type="checkbox"/> Magnetic Whiteboard <input type="checkbox"/> Mirror <input type="checkbox"/> Infant Change Table <input type="checkbox"/> Privacy Curtain
---	---	---	--	--

- LEGEND:**
- WALL AND CEILING LEGEND:**
- AC Architectural Ceiling
  - ACT Acoustic Ceiling Tile
  - ACT-C Cleanroom
  - ARGB Abuse-Resistant Gypsum Board
  - GB Gypsum Board
  - IRGB Impact-Resistant Gypsum Board
  - KLCT Kitchen Lay-in Ceiling Tile
  - MMRGB Moisture and Mould-Resistant Gypsum Board
  - SACT Security Acoustic Ceiling Tile
- WALL FINISHES LEGEND:**
- EWC Epoxy Wall Coating
  - HPC High Performance Coating
  - PT Paint
- CEILING FINISHES LEGEND:**
- ECC Epoxy Ceiling Coating
  - HPC High Performance Coating
  - PF Prefinished
  - PT Paint
- WALL PROTECTION LEGEND:**
- ESRP Extruded Semi-Rigid PVCu Panel
  - FRL Fibre Reinforced Laminata
  - FRP Fibreglass Reinforced Plastic
  - PVW Protective Vinyl Wallcovering
  - RHIS Rigid High Impact Sheet
  - WSSP Wetwall Solid Surface Panel
  - WVV Wetroom Vinyl Wallcovering
- FLOOR FINISHES LEGEND:**
- CFS Concrete Floor Sealer
  - EFC Epoxy Floor Coating
  - PFC Polyurethane Floor Coating
  - RAF Rubber Athletic Flooring
  - RSF Rubber Sheet Flooring
  - SCF Seamless Cushioned Flooring
  - SDRF Static-Dissipative Rubber Sheet Flooring
  - SDVF Static-Dissipative Vinyl Sheet Flooring
  - VSF Vinyl Sheet Flooring
  - WSVF Wetroom Safety Vinyl Sheet Flooring
- FLOOR BASE LEGEND:**
- FCB Flash Cove Base
  - RB Rubber Base
  - SCF Seamless Cushioned Flooring

**DOORS**

Types:

Type	Qty	Size (mm)	Material	Finish	Side Lt.	Blinds	Protect.	Privacy Film	Function	Card Reader	Mag Lock	Auto Opener	Hold Open	Hinges	Accessory 1	Accessory 2	Accessory 3	Closer
C2	1	1830 x 2135	Solid Core	FRL	<input type="checkbox"/>	<input type="checkbox"/>	2 High	<input type="checkbox"/>	Classroom	<input checked="" type="checkbox"/>	<input type="checkbox"/>	<input type="checkbox"/>	<input type="checkbox"/>	Butt Hinge	Astragal	Flush Bolt		Surface

Door Remarks:  Security Grille  Anti-barricade strategy

**MILLWORK AND SPECIALTY CASEWORK**

**UPPER UNITS** U1-U8

**LOWER UNITS** L1-L12

**RECEPTION/TRANSACTION COUNTER / CARE TEAM STATION DESK** TC1-TC2

**UTILITY SINK AND COUNTER UNIT** UC1

**Storage Requirements:**

**FINISHES**

- Full-height Cabinet:
- Upper Millwork:
- Countertop:
- Lower Millwork:
- Shelf:

Remarks:

**Legend:**

Category	Min. Length (mm)	Motorized Adjustable Height	Standing Height	Specialty Casework
3	12200	<input type="checkbox"/>	<input type="checkbox"/>	<input type="checkbox"/>

**MECHANICAL REQUIREMENTS**

**PLUMBING**

Hand Hygiene Sink:	Lavatory:	Kitchen Sink:	Seamless Kitchen Sink:	Utility / Process Sink:	Scrub Sink:	Floor Sink:
<input type="text"/>	<input type="text"/>	<input type="text"/>	<input type="text"/>	<input type="text"/>	<input type="text"/>	<input type="text"/>

Plumbing Remarks:

**Other Fixtures:**

- Shower
- Tub
- Ice Maker
- Water Closet
- Instantaneous Hot Water
- Eyewash Station
- Eyewash/Shower Station
- Emergency Shower
- Flush Rim Sink
- Floor Drain
- Water Bottle Refill Station
- Other:

**MED / NON-MED GASES**

Oxygen:	Medical Air:	Medical Vacuum:	Nitrous Oxide:	CO2:	AGSS:	Nitrogen:	Laboratory Air:	Laboratory Vacuum:	Utility Compressed Air:
<input type="text"/>	<input type="text"/>	<input type="text"/>	<input type="text"/>	<input type="text"/>	<input type="text"/>	<input type="text"/>	<input type="text"/>	<input type="text"/>	<input type="text"/>

Gas Remarks:

**Appendix 1B Minimum Room Requirements**

Room Name:

Program Number(s):

1. U6.07	7.	13.	19.	25.	31.	37.	43.
2.	8.	14.	20.	26.	32.	38.	44.
3.	9.	15.	21.	27.	33.	39.	45.
4.	10.	16.	22.	28.	34.	40.	46.
5.	11.	17.	23.	29.	35.	41.	47.
6.	12.	18.	24.	30.	36.	42.	48.

**ARCHITECTURAL REQUIREMENTS**

<b>WALL AND CEILING</b> Wall Material: <input type="text" value="ARGB 1.2m AFF, GB above"/> Finish: <input type="text" value="PT"/> Ceiling Material: <input type="text" value="ACT"/> Finish: <input type="text" value="PF"/>	<b>WALL PROTECTION</b> Type: <input type="text"/> Height: <input type="text"/> <input checked="" type="checkbox"/> Corner Guards <input type="checkbox"/> Hand Rails <input type="checkbox"/> Bed Bumper / Locator <input type="checkbox"/> Crash Rails <input type="checkbox"/> Chair Rail	<b>GLAZING</b> <input type="checkbox"/> Interior Glazing	<b>FLOORING TYPES</b> Material: <input type="text" value="VSF"/> Base: <input type="text" value="FCB"/>	<b>ROOM ACCESSORIES</b> <input type="checkbox"/> Coat Hooks <input type="checkbox"/> Ceiling Lift <input type="checkbox"/> Magnetic Whiteboard <input type="checkbox"/> Mirror <input type="checkbox"/> Infant Change Table <input type="checkbox"/> Privacy Curtain
--	--	---	--	--

- LEGEND:**
- WALL AND CEILING LEGEND:**
- AC Architectural Ceiling
  - ACT Acoustic Ceiling Tile
  - ACT-C Cleanroom
  - ARGB Abuse-Resistant Gypsum Board
  - GB Gypsum Board
  - IRGB Impact-Resistant Gypsum Board
  - KLCT Kitchen Lay-in Ceiling Tile
  - MMRGB Moisture and Mould-Resistant Gypsum Board
  - SACT Security Acoustic Ceiling Tile
- WALL FINISHES LEGEND:**
- EWC Epoxy Wall Coating
  - HPC High Performance Coating
  - PT Paint
- CEILING FINISHES LEGEND:**
- ECC Epoxy Ceiling Coating
  - HPC High Performance Coating
  - PF Prefinished
  - PT Paint
- WALL PROTECTION LEGEND:**
- ESRP Extruded Semi-Rigid PVCu Panel
  - FRL Fibre Reinforced Laminate
  - FRP Fibreglass Reinforced Plastic
  - PVV Protective Vinyl Wallcovering
  - RHIS Rigid High Impact Sheet
  - WSSP Wetwall Solid Surface Panel
  - WVV Wetroom Vinyl Wallcovering
- FLOOR FINISHES LEGEND:**
- CFS Concrete Floor Sealer
  - EFC Epoxy Floor Coating
  - PFC Polyurethane Floor Coating
  - RAF Rubber Athletic Flooring
  - RSF Rubber Sheet Flooring
  - SCF Seamless Cushioned Flooring
  - SDRF Static-Dissipative Rubber Sheet Flooring
  - SDVF Static-Dissipative Vinyl Sheet Flooring
  - VSF Vinyl Sheet Flooring
  - WSVF Wetroom Safety Vinyl Sheet Flooring
- FLOOR BASE LEGEND:**
- FCB Flash Cove Base
  - RB Rubber Base
  - SCF Seamless Cushioned Flooring

**DOORS**

Types:

Type	Qty	Size (mm)	Material	Finish	Side Lt.	Blinds	Protect.	Privacy Film	Function	Card Reader	Mag Lock	Auto Opener	Hold Open	Hinges	Accessory 1	Accessory 2	Accessory 3	Closer
C	1	1065 x 2135	Solid Core	FRL	<input type="checkbox"/>	<input type="checkbox"/>	2 High	<input checked="" type="checkbox"/>	Storeroom	<input checked="" type="checkbox"/>	<input type="checkbox"/>	<input type="checkbox"/>	<input type="checkbox"/>	Cont. Swing Clear				Surface

**DOOR REMARKS:**

Security Grille  
 Anti-barricade strategy

**MILLWORK AND SPECIALTY CASEWORK**

**UPPER UNITS:** U1, U2, U3, U4, U5, U6, U7, U8

**LOWER UNITS:** L1, L2, L3, L4, L5, L6, L7, L8, L9, L10, L11, L12

**RECEPTION/TRANSACTION COUNTER / CARE TEAM STATION DESK:** TC1, TC2

**UTILITY SINK AND COUNTER UNIT:** UC1

**SHELF:** S1

**Storage Requirements:**

**FINISHES**

Full-height Cabinet:   
 Upper Millwork:   
 Countertop:   
 Lower Millwork:   
 Shelf:

**Remarks:**

**Legend:**

Category	Min. Length (mm)	Motorized Adjustable Height	Standing Height	Specialty Casework
3	1800	<input type="checkbox"/>	<input type="checkbox"/>	<input type="checkbox"/>

**MECHANICAL REQUIREMENTS**

<b>PLUMBING</b> (Quantity) Hand Hygiene Sink: <input type="text"/> Lavatory: <input type="text"/> Kitchen Sink: <input type="text"/> Seamless Kitchen Sink: <input type="text"/> Utility / Process Sink: <input type="text"/> Scrub Sink: <input type="text"/> Floor Sink: <input type="text"/> Plumbing Remarks: <input type="text"/>	Other Fixtures: <input type="checkbox"/> Shower <input type="checkbox"/> Tub <input type="checkbox"/> Ice Maker <input type="checkbox"/> Water Closet <input type="checkbox"/> Instantaneous Hot Water <input type="checkbox"/> Eyewash Station <input type="checkbox"/> Eyewash/Shower Station <input type="checkbox"/> Emergency Shower <input type="checkbox"/> Flush Rim Sink <input type="checkbox"/> Floor Drain <input type="checkbox"/> Water Bottle Refill Station Other: <input type="text"/>	<b>MED / NON-MED GASES</b> (Quantity) Oxygen: <input type="text"/> Medical Air: <input type="text"/> Medical Vacuum: <input type="text"/> Nitrous Oxide: <input type="text"/> CO2: <input type="text"/> AGSS: <input type="text"/> Nitrogen: <input type="text"/> Laboratory Air: <input type="text"/> Laboratory Vacuum: <input type="text"/> Utility Compressed Air: <input type="text"/> Gas Remarks: <input type="text"/>
---	---	---



**Appendix 1B Minimum Room Requirements**

Room Name:

Program Number(s):

1. U6.01	7.	13.	19.	25.	31.	37.	43.
2.	8.	14.	20.	26.	32.	38.	44.
3.	9.	15.	21.	27.	33.	39.	45.
4.	10.	16.	22.	28.	34.	40.	46.
5.	11.	17.	23.	29.	35.	41.	47.
6.	12.	18.	24.	30.	36.	42.	48.

**ARCHITECTURAL REQUIREMENTS**

<b>WALL AND CEILING</b> Wall Material: <input type="text" value="ARGB 1.2m AFF, GB above"/> Finish: <input type="text" value="PT"/> Ceiling Material: <input type="text" value="ACT"/> Finish: <input type="text" value="PF"/>	<b>WALL PROTECTION</b> Type: <input type="text" value="PVW"/> <input checked="" type="checkbox"/> Corner Guards <input type="checkbox"/> Hand Rails <input type="checkbox"/> Bed Bumper / Locator Height: <input type="text" value="1350 mm"/> <input type="checkbox"/> Crash Rails <input checked="" type="checkbox"/> Chair Rail	<b>GLAZING</b> <input type="checkbox"/> Interior Glazing	<b>FLOORING TYPES</b> Material: <input type="text" value="RSF"/> Base: <input type="text" value="RB"/>	<b>ROOM ACCESSORIES</b> <input checked="" type="checkbox"/> Coat Hooks <input type="checkbox"/> Ceiling Lift <input checked="" type="checkbox"/> Magnetic Whiteboard <input type="checkbox"/> Mirror <input type="checkbox"/> Infant Change Table <input type="checkbox"/> Privacy Curtain
--	--	---	---	--

- LEGEND:**
- WALL AND CEILING LEGEND:**
- AC Architectural Ceiling
  - ACT Acoustic Ceiling Tile
  - ACT-C Cleanroom
  - ARGB Abuse-Resistant Gypsum Board
  - GB Gypsum Board
  - IRGB Impact-Resistant Gypsum Board
  - KLCT Kitchen Lay-in Ceiling Tile
  - MMRGB Moisture and Mould-Resistant Gypsum Board
  - SACT Security Acoustic Ceiling Tile
- WALL FINISHES LEGEND:**
- EWC Epoxy Wall Coating
  - HPC High Performance Coating
  - PT Paint
- CEILING FINISHES LEGEND:**
- ECC Epoxy Ceiling Coating
  - HPC High Performance Coating
  - PF Prefinished
  - PT Paint
- WALL PROTECTION LEGEND:**
- ESRP Extruded Semi-Rigid PVCu Panel
  - FRL Fibre Reinforced Laminate
  - FRP Fibreglass Reinforced Plastic
  - PVW Protective Vinyl Wallcovering
  - RHIS Rigid High Impact Sheet
  - WSSP Wetwall Solid Surface Panel
  - WVV Wetroom Vinyl Wallcovering
- FLOOR FINISHES LEGEND:**
- CFS Concrete Floor Sealer
  - EFC Epoxy Floor Coating
  - PFC Polyurethane Floor Coating
  - RAF Rubber Athletic Flooring
  - RSF Rubber Sheet Flooring
  - SCF Seamless Cushioned Flooring
  - SDRF Static-Dissipative Rubber Sheet Flooring
  - SDVF Static-Dissipative Vinyl Sheet Flooring
  - VSF Vinyl Sheet Flooring
  - WSVF Wetroom Safety Vinyl Sheet Flooring
- FLOOR BASE LEGEND:**
- FCB Flash Cove Base
  - RB Rubber Base
  - SCF Seamless Cushioned Flooring

**DOORS**

Types:

Type	Qty	Size (mm)	Material	Finish	Side Lt.	Blinds	Protect.	Privacy Film	Function	Card Reader	Mag Lock	Auto Opener	Hold Open	Hinges	Accessory 1	Accessory 2	Accessory 3	Closer
C	2	1065 x 2135	Solid Core	FRL	<input type="checkbox"/>	<input type="checkbox"/>	2 High	<input type="checkbox"/>	Storeroom	<input checked="" type="checkbox"/>	<input type="checkbox"/>	<input type="checkbox"/>	<input type="checkbox"/>	Butt Hinge				Surface

Door Remarks:  Security Grille  Anti-barricade strategy



**MECHANICAL REQUIREMENTS**

<b>PLUMBING</b> (Quantity) Hand Hygiene Sink: <input type="text"/> Lavatory: <input type="text"/> Kitchen Sink: <input type="text"/> Seamless Kitchen Sink: <input type="text"/> Utility / Process Sink: <input type="text"/> Scrub Sink: <input type="text"/> Floor Sink: <input type="text"/> Plumbing Remarks: <input type="text"/>	Other Fixtures: <input type="checkbox"/> Shower <input type="checkbox"/> Eyewash Station <input type="checkbox"/> Tub <input type="checkbox"/> Eyewash/Shower Station <input type="checkbox"/> Ice Maker <input type="checkbox"/> Emergency Shower <input type="checkbox"/> Water Closet <input type="checkbox"/> Flush Rim Sink <input type="checkbox"/> Instantaneous Hot Water <input type="checkbox"/> Floor Drain <input type="checkbox"/> <input type="checkbox"/> Water Bottle Refill Station Other: <input type="text"/>	<b>MED / NON-MED GASES</b> (Quantity) Oxygen: <input type="text"/> Medical Air: <input type="text"/> Medical Vacuum: <input type="text"/> Nitrous Oxide: <input type="text"/> CO2: <input type="text"/> AGSS: <input type="text"/> Nitrogen: <input type="text"/> Laboratory Air: <input type="text"/> Laboratory Vacuum: <input type="text"/> Utility Compressed Air: <input type="text"/> Gas Remarks: <input type="text"/>
---	---	---

---

# New Surrey Hospital & BC Cancer Centre

MINIMUM ROOM REQUIREMENTS

## V. Meeting and Education

---

**Appendix 1B Minimum Room Requirements**

Room Name:

Program Number(s):	1. V1.08	7.	13.	19.	25.	31.	37.	43.
	2.	8.	14.	20.	26.	32.	38.	44.
	3.	9.	15.	21.	27.	33.	39.	45.
	4.	10.	16.	22.	28.	34.	40.	46.
	5.	11.	17.	23.	29.	35.	41.	47.
	6.	12.	18.	24.	30.	36.	42.	48.

**ARCHITECTURAL REQUIREMENTS**

<b>WALL AND CEILING</b> Wall Material: <input type="text" value="GB"/> Finish: <input type="text" value="PT"/> Ceiling Material: <input type="text" value="ACT"/> Finish: <input type="text" value="PF"/>		<b>WALL PROTECTION</b> Type: <input type="text" value="RHIS"/> <input checked="" type="checkbox"/> Corner Guards <input type="checkbox"/> Hand Rails <input type="checkbox"/> Bed Bumper / Locator Height: <input type="text" value="1350 mm"/> <input type="checkbox"/> Crash Rails <input checked="" type="checkbox"/> Chair Rail		<b>GLAZING</b> <input type="checkbox"/> Interior Glazing		<b>FLOORING TYPES</b> Material: <input type="text" value="RSF"/> Base: <input type="text" value="FCB"/>		<b>ROOM ACCESSORIES</b> <input checked="" type="checkbox"/> Coat Hooks <input type="checkbox"/> Ceiling Lift <input checked="" type="checkbox"/> Magnetic Whiteboard <input type="checkbox"/> Mirror <input type="checkbox"/> Infant Change Table <input type="checkbox"/> Privacy Curtain	
---	--	---	--	---	--	--	--	--	--

- LEGEND:**
- WALL AND CEILING LEGEND:**
- AC Architectural Ceiling
  - ACT Acoustic Ceiling Tile
  - ACT-C Cleanroom
  - ARGB Abuse-Resistant Gypsum Board
  - GB Gypsum Board
  - IRGB Impact-Resistant Gypsum Board
  - KLCT Kitchen Lay-in Ceiling Tile
  - MMRGB Moisture and Mould-Resistant Gypsum Board
  - SACT Security Acoustic Ceiling Tile
- WALL FINISHES LEGEND:**
- EWC Epoxy Wall Coating
  - HPC High Performance Coating
  - PT Paint
- CEILING FINISHES LEGEND:**
- ECC Epoxy Ceiling Coating
  - HPC High Performance Coating
  - PF Prefinished
  - PT Paint
- WALL PROTECTION LEGEND:**
- ESRP Extruded Semi-Rigid PVCu Panel
  - FRL Fibre Reinforced Laminate
  - FRP Fibreglass Reinforced Plastic
  - PVV Protective Vinyl Wallcovering
  - RHIS Rigid High Impact Sheet
  - WSSP Wetwall Solid Surface Panel
  - WVV Wetroom Vinyl Wallcovering
- FLOOR FINISHES LEGEND:**
- CFS Concrete Floor Sealer
  - EFC Epoxy Floor Coating
  - PFC Polyurethane Floor Coating
  - RAF Rubber Athletic Flooring
  - RSF Rubber Sheet Flooring
  - SCF Seamless Cushioned Flooring
  - SDRF Static-Dissipative Rubber Sheet Flooring
  - SDVF Static-Dissipative Vinyl Sheet Flooring
  - VSF Vinyl Sheet Flooring
  - WSVF Wetroom Safety Vinyl Sheet Flooring
- FLOOR BASE LEGEND:**
- FCB Flash Cove Base
  - RB Rubber Base
  - SCF Seamless Cushioned Flooring

**DOORS**

Types:

Type	Qty	Size (mm)	Material	Finish	Side Lt.	Blinds	Protect.	Privacy Film	Function	Card Reader	Mag Lock	Auto Opener	Hold Open	Hinges	Accessory 1	Accessory 2	Accessory 3	Closer
C	1	1065 x 2135	Solid Core	FRL	<input type="checkbox"/>	<input type="checkbox"/>	1 Low	<input type="checkbox"/>	Storeroom	<input checked="" type="checkbox"/>	<input type="checkbox"/>	<input type="checkbox"/>	<input type="checkbox"/>	Butt Hinge				Surface

**Door Remarks:**

Security Grille  
 Anti-barricade strategy

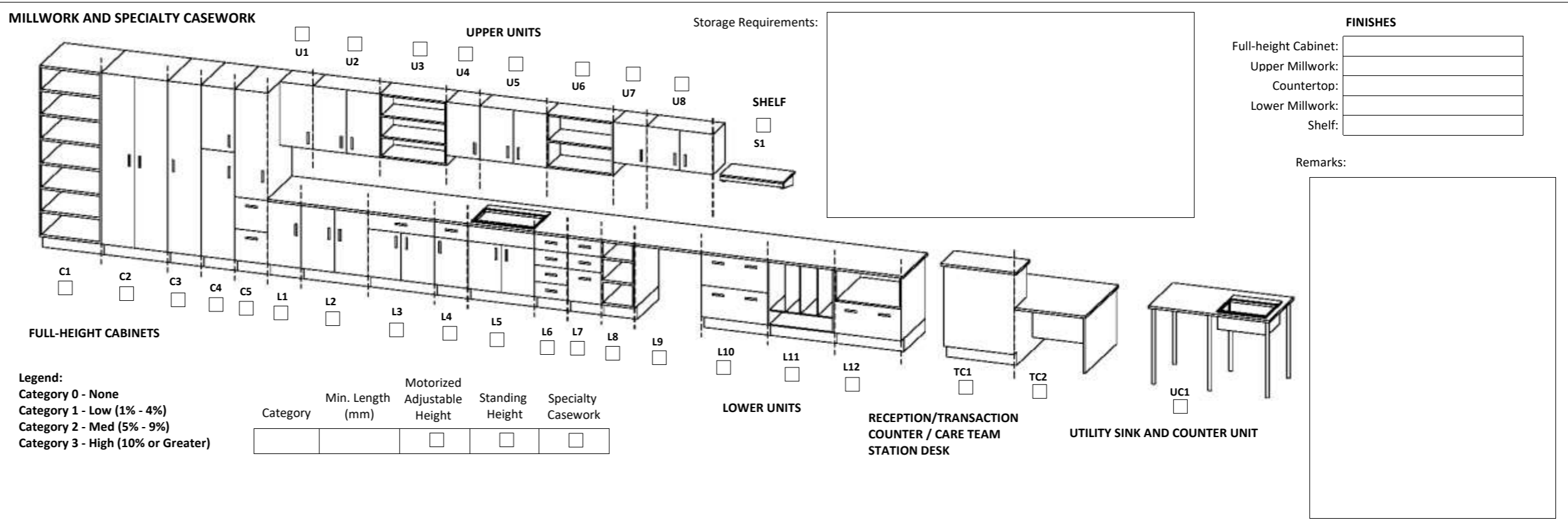

**MECHANICAL REQUIREMENTS**

<b>PLUMBING</b> (Quantity) Hand Hygiene Sink: <input type="text"/> Lavatory: <input type="text"/> Kitchen Sink: <input type="text"/> Seamless Kitchen Sink: <input type="text"/> Utility / Process Sink: <input type="text"/> Scrub Sink: <input type="text"/> Floor Sink: <input type="text"/> Plumbing Remarks: <input type="text"/>		Other Fixtures: <input type="checkbox"/> Shower <input type="checkbox"/> Eyewash Station <input type="checkbox"/> Tub <input type="checkbox"/> Eyewash/Shower Station <input type="checkbox"/> Ice Maker <input type="checkbox"/> Emergency Shower <input type="checkbox"/> Water Closet <input type="checkbox"/> Flush Rim Sink <input type="checkbox"/> Instantaneous Hot Water <input type="checkbox"/> Floor Drain <input type="checkbox"/> <input type="checkbox"/> Water Bottle Refill Station Other <input type="text"/>		<b>MED / NON-MED GASES</b> (Quantity) Oxygen: <input type="text"/> Medical Air: <input type="text"/> Medical Vacuum: <input type="text"/> Nitrous Oxide: <input type="text"/> CO2: <input type="text"/> AGSS: <input type="text"/> Nitrogen: <input type="text"/> Laboratory Air: <input type="text"/> Laboratory Vacuum: <input type="text"/> Utility Compressed Air: <input type="text"/> Gas Remarks: <input type="text"/>	
---	--	--	--	--	--



**Appendix 1B Minimum Room Requirements**

Room Name:

Program Number(s):	1. V1.13	7.	13.	19.	25.	31.	37.	43.
	2.	8.	14.	20.	26.	32.	38.	44.
	3.	9.	15.	21.	27.	33.	39.	45.
	4.	10.	16.	22.	28.	34.	40.	46.
	5.	11.	17.	23.	29.	35.	41.	47.
	6.	12.	18.	24.	30.	36.	42.	48.

**ARCHITECTURAL REQUIREMENTS**

<b>WALL AND CEILING</b> Wall Material: <input type="text" value="GB"/> Finish: <input type="text" value="PT"/> Ceiling Material: <input type="text" value="ACT"/> Finish: <input type="text" value="PF"/>	<b>WALL PROTECTION</b> Type: <input type="text"/> Height: <input type="text"/> <input checked="" type="checkbox"/> Corner Guards <input type="checkbox"/> Hand Rails <input type="checkbox"/> Bed Bumper / Locator <input type="checkbox"/> Crash Rails <input checked="" type="checkbox"/> Chair Rail	<b>GLAZING</b> <input type="checkbox"/> Interior Glazing	<b>FLOORING TYPES</b> Material: <input type="text" value="RSF"/> Base: <input type="text" value="RB"/>	<b>ROOM ACCESSORIES</b> <input checked="" type="checkbox"/> Coat Hooks <input type="checkbox"/> Ceiling Lift <input checked="" type="checkbox"/> Magnetic Whiteboard <input type="checkbox"/> Mirror <input type="checkbox"/> Infant Change Table <input type="checkbox"/> Privacy Curtain
---	---	---	---	--

- LEGEND:**
- WALL AND CEILING LEGEND:**
- AC Architectural Ceiling
  - ACT Acoustic Ceiling Tile
  - ACT-C Cleanroom
  - ARGB Abuse-Resistant Gypsum Board
  - GB Gypsum Board
  - IRGB Impact-Resistant Gypsum Board
  - KLCT Kitchen Lay-in Ceiling Tile
  - MMRGB Moisture and Mould-Resistant Gypsum Board
  - SACT Security Acoustic Ceiling Tile
- WALL FINISHES LEGEND:**
- EWC Epoxy Wall Coating
  - HPC High Performance Coating
  - PT Paint
- CEILING FINISHES LEGEND:**
- ECC Epoxy Ceiling Coating
  - HPC High Performance Coating
  - PF Prefinished
  - PT Paint
- WALL PROTECTION LEGEND:**
- ESRP Extruded Semi-Rigid PVCu Panel
  - FRL Fibre Reinforced Laminate
  - FRP Fibreglass Reinforced Plastic
  - PVV Protective Vinyl Wallcovering
  - RHIS Rigid High Impact Sheet
  - WSSP Wetwall Solid Surface Panel
  - WVV Wetroom Vinyl Wallcovering
- FLOOR FINISHES LEGEND:**
- CFS Concrete Floor Sealer
  - EFC Epoxy Floor Coating
  - PFC Polyurethane Floor Coating
  - RAF Rubber Athletic Flooring
  - RSF Rubber Sheet Flooring
  - SCF Seamless Cushioned Flooring
  - SDRF Static-Dissipative Rubber Sheet Flooring
  - SDVF Static-Dissipative Vinyl Sheet Flooring
  - VSF Vinyl Sheet Flooring
  - WSVF Wetroom Safety Vinyl Sheet Flooring
- FLOOR BASE LEGEND:**
- FCB Flash Cove Base
  - RB Rubber Base
  - SCF Seamless Cushioned Flooring

**DOORS**

Types:

Type	Qty	Size (mm)	Material	Finish	Side Lt.	Blinds	Protect.	Privacy Film	Function	Card Reader	Mag Lock	Auto Opener	Hold Open	Hinges	Accessory 1	Accessory 2	Accessory 3	Closer
C	2	915 x 2135	Solid Core	FRL	<input type="checkbox"/>	<input type="checkbox"/>	1 Low	<input type="checkbox"/>	Storeroom	<input checked="" type="checkbox"/>	<input type="checkbox"/>	<input type="checkbox"/>	<input type="checkbox"/>	Butt Hinge				Surface

Door Remarks:

Security Grille  
 Anti-barricade strategy

**MILLWORK AND SPECIALTY CASEWORK**

**UPPER UNITS** (U1-U8) **LOWER UNITS** (L1-L12) **RECEPTION/TRANSACTION COUNTER / CARE TEAM STATION DESK** (TC1-TC2) **UTILITY SINK AND COUNTER UNIT** (UC1)

Storage Requirements:

**FINISHES**

Full-height Cabinet:   
 Upper Millwork:   
 Countertop:   
 Lower Millwork:   
 Shelf:

Remarks:

Category	Min. Length (mm)	Motorized Adjustable Height	Standing Height	Specialty Casework
1	1800	<input type="checkbox"/>	<input type="checkbox"/>	<input type="checkbox"/>

**MECHANICAL REQUIREMENTS**

<b>PLUMBING</b> (Quantity) Hand Hygiene Sink: <input type="text"/> Lavatory: <input type="text"/> Kitchen Sink: <input type="text"/> Seamless Kitchen Sink: <input type="text"/> Utility / Process Sink: <input type="text"/> Scrub Sink: <input type="text"/> Floor Sink: <input type="text"/> Plumbing Remarks: <input type="text"/>	Other Fixtures: <input type="checkbox"/> Shower <input type="checkbox"/> Tub <input type="checkbox"/> Ice Maker <input type="checkbox"/> Water Closet <input type="checkbox"/> Instantaneous Hot Water <input type="checkbox"/> Eyewash Station <input type="checkbox"/> Eyewash/Shower Station <input type="checkbox"/> Emergency Shower <input type="checkbox"/> Flush Rim Sink <input type="checkbox"/> Floor Drain <input type="checkbox"/> Water Bottle Refill Station Other: <input type="text"/>	<b>MED / NON-MED GASES</b> (Quantity) Oxygen: <input type="text"/> Medical Air: <input type="text"/> Medical Vacuum: <input type="text"/> Nitrous Oxide: <input type="text"/> CO2: <input type="text"/> AGSS: <input type="text"/> Nitrogen: <input type="text"/> Laboratory Air: <input type="text"/> Laboratory Vacuum: <input type="text"/> Utility Compressed Air: <input type="text"/> Gas Remarks: <input type="text"/>
--	--	---

---

# New Surrey Hospital & BC Cancer Centre

MINIMUM ROOM REQUIREMENTS

**W. Back Of House**

---

**Appendix 1B Minimum Room Requirements**

Room Name:

Program Number(s):

1. W2.09	7.	13.	19.	25.	31.	37.	43.
2.	8.	14.	20.	26.	32.	38.	44.
3.	9.	15.	21.	27.	33.	39.	45.
4.	10.	16.	22.	28.	34.	40.	46.
5.	11.	17.	23.	29.	35.	41.	47.
6.	12.	18.	24.	30.	36.	42.	48.

**ARCHITECTURAL REQUIREMENTS**

<b>WALL AND CEILING</b> Wall Material: <input type="text" value="MMRGB"/> Finish: <input type="text" value="PT"/> Ceiling Material: <input type="text" value="GB"/> Finish: <input type="text" value="PT"/>	<b>WALL PROTECTION</b> Type: <input type="text" value="WVW"/> <input checked="" type="checkbox"/> Corner Guards <input type="checkbox"/> Hand Rails <input type="checkbox"/> Bed Bumper / Locator Height: <input type="text" value="2185 mm"/> <input checked="" type="checkbox"/> Crash Rails <input type="checkbox"/> Chair Rail	<b>GLAZING</b> <input type="checkbox"/> Interior Glazing	<b>FLOORING TYPES</b> Material: <input type="text" value="WSVF"/> Base: <input type="text" value="FCB"/>	<b>ROOM ACCESSORIES</b> <input type="checkbox"/> Coat Hooks <input type="checkbox"/> Ceiling Lift <input type="checkbox"/> Magnetic Whiteboard <input type="checkbox"/> Mirror <input type="checkbox"/> Infant Change Table <input type="checkbox"/> Privacy Curtain
---	--	---	---	--

- LEGEND:**
- WALL AND CEILING LEGEND:**
- AC Architectural Ceiling
  - ACT Acoustic Ceiling Tile
  - ACT-C Cleanroom
  - ARGB Abuse-Resistant Gypsum Board
  - GB Gypsum Board
  - IRGB Impact-Resistant Gypsum Board
  - KLCT Kitchen Lay-in Ceiling Tile
  - MMRGB Moisture and Mould-Resistant Gypsum Board
  - SACT Security Acoustic Ceiling Tile
- WALL FINISHES LEGEND:**
- EWC Epoxy Wall Coating
  - HPC High Performance Coating
  - PT Paint
- CEILING FINISHES LEGEND:**
- ECC Epoxy Ceiling Coating
  - HPC High Performance Coating
  - PF Prefinished
  - PT Paint
- WALL PROTECTION LEGEND:**
- ESRP Extruded Semi-Rigid PVCu Panel
  - FRL Fibre Reinforced Laminate
  - FRP Fibreglass Reinforced Plastic
  - PVW Protective Vinyl Wallcovering
  - RHIS Rigid High Impact Sheet
  - WSSP Wetwall Solid Surface Panel
  - WVV Wetroom Vinyl Wallcovering
- FLOOR FINISHES LEGEND:**
- CFS Concrete Floor Sealer
  - EFC Epoxy Floor Coating
  - PFC Polyurethane Floor Coating
  - RAF Rubber Athletic Flooring
  - RSF Rubber Sheet Flooring
  - SCF Seamless Cushioned Flooring
  - SDRF Static-Dissipative Rubber Sheet Flooring
  - SDVF Static-Dissipative Vinyl Sheet Flooring
  - VSF Vinyl Sheet Flooring
  - WSVF Wetroom Safety Vinyl Sheet Flooring
- FLOOR BASE LEGEND:**
- FCB Flash Cove Base
  - RB Rubber Base
  - SCF Seamless Cushioned Flooring

**DOORS**

Types:

Type	Qty	Size (mm)	Material	Finish	Side Lt.	Blinds	Protect.	Privacy Film	Function	Card Reader	Mag Lock	Auto Opener	Hold Open	Hinges	Accessory 1	Accessory 2	Accessory 3	Closer

Door Remarks:  Security Grille  Anti-barricade strategy

**MILLWORK AND SPECIALTY CASEWORK**

Storage Requirements:

**UPPER UNITS** (U1-U8) **SHELF** (S1)

**FULL-HEIGHT CABINETS** (C1-C5) **LOWER UNITS** (L1-L12) **RECEPTION/TRANSACTION COUNTER / CARE TEAM STATION DESK** (TC1-TC2) **UTILITY SINK AND COUNTER UNIT** (UC1)

Category	Min. Length (mm)	Motorized Adjustable Height	Standing Height	Specialty Casework
Category 0 - None				
Category 1 - Low (1% - 4%)				
Category 2 - Med (5% - 9%)				
Category 3 - High (10% or Greater)				

**FINISHES**

Full-height Cabinet:   
 Upper Millwork:   
 Countertop:   
 Lower Millwork:   
 Shelf:

Remarks:

**MECHANICAL REQUIREMENTS**

<b>PLUMBING</b> (Quantity) Hand Hygiene Sink: <input type="text" value="1"/> Lavatory: <input type="text"/> Kitchen Sink: <input type="text"/> Seamless Kitchen Sink: <input type="text"/> Utility / Process Sink: <input type="text"/> Scrub Sink: <input type="text"/> Floor Sink: <input type="text"/> Plumbing Remarks: <input type="text"/>	Other Fixtures: <input type="checkbox"/> Shower <input type="checkbox"/> Tub <input type="checkbox"/> Ice Maker <input type="checkbox"/> Water Closet <input type="checkbox"/> Instantaneous Hot Water <input type="checkbox"/> Eyewash Station <input type="checkbox"/> Eyewash/Shower Station <input type="checkbox"/> Emergency Shower <input type="checkbox"/> Flush Rim Sink <input checked="" type="checkbox"/> Floor Drain <input type="checkbox"/> Water Bottle Refill Station Other: <input type="text"/>	<b>MED / NON-MED GASES</b> (Quantity) Oxygen: <input type="text"/> Medical Air: <input type="text"/> Medical Vacuum: <input type="text"/> Nitrous Oxide: <input type="text"/> CO2: <input type="text"/> AGSS: <input type="text"/> Nitrogen: <input type="text"/> Laboratory Air: <input type="text"/> Laboratory Vacuum: <input type="text"/> Utility Compressed Air: <input type="text"/> Gas Remarks: <input type="text"/>
--	---	---



**Appendix 1B Minimum Room Requirements**

Room Name:

Program Number(s):

1.	W3.04	7.		13.		19.		25.		31.		37.		43.
2.		8.		14.		20.		26.		32.		38.		44.
3.		9.		15.		21.		27.		33.		39.		45.
4.		10.		16.		22.		28.		34.		40.		46.
5.		11.		17.		23.		29.		35.		41.		47.
6.		12.		18.		24.		30.		36.		42.		48.

**ARCHITECTURAL REQUIREMENTS**

<b>WALL AND CEILING</b> Wall Material: <input type="text" value="ARGB 1.2m AFF, GB above"/> Finish: <input type="text" value="PT"/> Ceiling Material: <input type="text" value="ACT"/> Finish: <input type="text" value="PF"/>		<b>WALL PROTECTION</b> Type: <input type="text" value="RHIS"/> <input checked="" type="checkbox"/> Corner Guards <input type="checkbox"/> Hand Rails <input type="checkbox"/> Bed Bumper / Locator Height: <input type="text" value="2185 mm"/> <input checked="" type="checkbox"/> Crash Rails <input type="checkbox"/> Chair Rail			<b>GLAZING</b> <input type="checkbox"/> Interior Glazing		<b>FLOORING TYPES</b> Material: <input type="text" value="VSF"/> Base: <input type="text" value="FCB"/>		<b>ROOM ACCESSORIES</b> <input type="checkbox"/> Coat Hooks <input type="checkbox"/> Ceiling Lift <input checked="" type="checkbox"/> Magnetic Whiteboard <input type="checkbox"/> Mirror <input type="checkbox"/> Infant Change Table <input type="checkbox"/> Privacy Curtain		
--	--	---	--	--	---	--	--	--	---	--	--

- LEGEND:**
- WALL AND CEILING LEGEND:**
- AC Architectural Ceiling
  - ACT Acoustic Ceiling Tile
  - ACT-C Cleanroom
  - ARGB Abuse-Resistant Gypsum Board
  - GB Gypsum Board
  - IRGB Impact-Resistant Gypsum Board
  - KLCT Kitchen Lay-in Ceiling Tile
  - MMRGB Moisture and Mould-Resistant Gypsum Board
  - SACT Security Acoustic Ceiling Tile
- WALL FINISHES LEGEND:**
- EWC Epoxy Wall Coating
  - HPC High Performance Coating
  - PT Paint
- CEILING FINISHES LEGEND:**
- ECC Epoxy Ceiling Coating
  - HPC High Performance Coating
  - PF Prefinished
  - PT Paint
- WALL PROTECTION LEGEND:**
- ESRP Extruded Semi-Rigid PVCu Panel
  - FRL Fibre Reinforced Laminate
  - FRP Fibreglass Reinforced Plastic
  - PVV Protective Vinyl Wallcovering
  - RHIS Rigid High Impact Sheet
  - WSSP Wetwall Solid Surface Panel
  - WVV Wetroom Vinyl Wallcovering
- FLOOR FINISHES LEGEND:**
- CFS Concrete Floor Sealer
  - EFC Epoxy Floor Coating
  - PFC Polyurethane Floor Coating
  - RAF Rubber Athletic Flooring
  - RSF Rubber Sheet Flooring
  - SCF Seamless Cushioned Flooring
  - SDRF Static-Dissipative Rubber Sheet Flooring
  - SDVF Static-Dissipative Vinyl Sheet Flooring
  - VSF Vinyl Sheet Flooring
  - WSVF Wetroom Safety Vinyl Sheet Flooring
- FLOOR BASE LEGEND:**
- FCB Flash Cove Base
  - RB Rubber Base
  - SCF Seamless Cushioned Flooring

**DOORS**

Types:

Type:Qty:	Size (mm):	Material:	Finish:	Side Lt:	Blinds:	Protect.:	Privacy Film:	Function:	Card Reader:	Mag Lock:	Auto Opener:	Hold Open:	Hinges:	Accessory 1:	Accessory 2:	Accessory 3:	Closer:
C2 1	1830 x 2135	Solid Core	FRL	<input type="checkbox"/>	<input type="checkbox"/>	2 High	<input checked="" type="checkbox"/>	Storeroom	<input checked="" type="checkbox"/>	<input type="checkbox"/>	<input checked="" type="checkbox"/>	<input checked="" type="checkbox"/>	Cont. Swing Clear	Astragal	Flush Bolt	Elec. Strike	Surface

Door Remarks:  Security Grille  Anti-barricade strategy



**MECHANICAL REQUIREMENTS**

<b>PLUMBING</b> (Quantity) Hand Hygiene Sink: <input type="text"/> Lavatory: <input type="text"/> Kitchen Sink: <input type="text"/> Seamless Kitchen Sink: <input type="text"/> Utility / Process Sink: <input type="text"/> Scrub Sink: <input type="text"/> Floor Sink: <input type="text"/>							Other Fixtures: <input type="checkbox"/> Shower <input type="checkbox"/> Eyewash Station <input type="checkbox"/> Tub <input type="checkbox"/> Eyewash/Shower Station <input type="checkbox"/> Ice Maker <input type="checkbox"/> Emergency Shower <input type="checkbox"/> Water Closet <input type="checkbox"/> Flush Rim Sink <input type="checkbox"/> Instantaneous Hot Water <input type="checkbox"/> Floor Drain <input type="checkbox"/> Water Bottle Refill Station Other: <input type="text"/>				<b>MED / NON-MED GASES</b> (Quantity) Oxygen: <input type="text"/> Medical Air: <input type="text"/> Medical Vacuum: <input type="text"/> Nitrous Oxide: <input type="text"/> CO2: <input type="text"/> AGSS: <input type="text"/> Nitrogen: <input type="text"/> Laboratory Air: <input type="text"/> Laboratory Vacuum: <input type="text"/> Utility Compressed Air: <input type="text"/>					
Plumbing Remarks: <input type="text"/>											Gas Remarks: <input type="text"/>					

**Appendix 1B Minimum Room Requirements**

Room Name:

Program Number(s):

1. W2.06	7.	13.	19.	25.	31.	37.	43.
2.	8.	14.	20.	26.	32.	38.	44.
3.	9.	15.	21.	27.	33.	39.	45.
4.	10.	16.	22.	28.	34.	40.	46.
5.	11.	17.	23.	29.	35.	41.	47.
6.	12.	18.	24.	30.	36.	42.	48.

**ARCHITECTURAL REQUIREMENTS**

<b>WALL AND CEILING</b> Wall Material: <input type="text" value="ARGB 1.2m AFF, GB above"/> Finish: <input type="text" value="PT"/> Ceiling Material: <input type="text" value="ACT"/> Finish: <input type="text" value="PF"/>	<b>WALL PROTECTION</b> Type: <input type="text" value="PVW"/> <input checked="" type="checkbox"/> Corner Guards <input type="checkbox"/> Hand Rails <input type="checkbox"/> Bed Bumper / Locator Height: <input type="text" value="2185 mm"/> <input checked="" type="checkbox"/> Crash Rails <input type="checkbox"/> Chair Rail	<b>GLAZING</b> <input type="checkbox"/> Interior Glazing	<b>FLOORING TYPES</b> Material: <input type="text" value="WSVF"/> Base: <input type="text" value="FCB"/>	<b>ROOM ACCESSORIES</b> <input type="checkbox"/> Coat Hooks <input type="checkbox"/> Ceiling Lift <input checked="" type="checkbox"/> Magnetic Whiteboard <input type="checkbox"/> Mirror <input type="checkbox"/> Infant Change Table <input type="checkbox"/> Privacy Curtain
--	--	---	---	---

- LEGEND:**
- WALL AND CEILING LEGEND:**
- AC Architectural Ceiling
  - ACT Acoustic Ceiling Tile
  - ACT-C Cleanroom
  - ARGB Abuse-Resistant Gypsum Board
  - GB Gypsum Board
  - IRGB Impact-Resistant Gypsum Board
  - KLCT Kitchen Lay-in Ceiling Tile
  - MMRGB Moisture and Mould-Resistant Gypsum Board
  - SACT Security Acoustic Ceiling Tile
- WALL FINISHES LEGEND:**
- EWC Epoxy Wall Coating
  - HPC High Performance Coating
  - PT Paint
- CEILING FINISHES LEGEND:**
- ECC Epoxy Ceiling Coating
  - HPC High Performance Coating
  - PF Prefinished
  - PT Paint
- WALL PROTECTION LEGEND:**
- ESRP Extruded Semi-Rigid PVCu Panel
  - FRL Fibre Reinforced Laminate
  - FRP Fibreglass Reinforced Plastic
  - PVW Protective Vinyl Wallcovering
  - RHIS Rigid High Impact Sheet
  - WSSP Wetwall Solid Surface Panel
  - WVV Wetroom Vinyl Wallcovering
- FLOOR FINISHES LEGEND:**
- CFS Concrete Floor Sealer
  - EFC Epoxy Floor Coating
  - PFC Polyurethane Floor Coating
  - RAF Rubber Athletic Flooring
  - RSF Rubber Sheet Flooring
  - SCF Seamless Cushioned Flooring
  - SDRF Static-Dissipative Rubber Sheet Flooring
  - SDVF Static-Dissipative Vinyl Sheet Flooring
  - VSF Vinyl Sheet Flooring
  - WSVF Wetroom Safety Vinyl Sheet Flooring
- FLOOR BASE LEGEND:**
- FCB Flash Cove Base
  - RB Rubber Base
  - SCF Seamless Cushioned Flooring

**DOORS**

Types:

Type	Qty	Size (mm)	Material	Finish	Side Lt.	Blinds	Protect.	Privacy Film	Function	Card Reader	Mag Lock	Auto Opener	Hold Open	Hinges	Accessory 1	Accessory 2	Accessory 3	Closer
C2	2	1830 x 2135	Hollow Metal	Paint	<input type="checkbox"/>	<input type="checkbox"/>	2 High	<input type="checkbox"/>	Storeroom	<input checked="" type="checkbox"/>	<input type="checkbox"/>	<input checked="" type="checkbox"/>	<input checked="" type="checkbox"/>	Butt Hinge	Astragal	Flush Bolt	Elec. Strike	Surface

Door Remarks:  Security Grille  Anti-barricade strategy



**MECHANICAL REQUIREMENTS**

<b>PLUMBING</b> (Quantity) Hand Hygiene Sink: <input type="text"/> Lavatory: <input type="text"/> Kitchen Sink: <input type="text"/> Seamless Kitchen Sink: <input type="text"/> Utility / Process Sink: <input type="text"/> Scrub Sink: <input type="text"/> Floor Sink: <input type="text"/> Plumbing Remarks: <input type="text"/>	Other Fixtures: <input type="checkbox"/> Shower <input type="checkbox"/> Eyewash Station <input type="checkbox"/> Tub <input type="checkbox"/> Eyewash/Shower Station <input type="checkbox"/> Ice Maker <input type="checkbox"/> Emergency Shower <input type="checkbox"/> Water Closet <input type="checkbox"/> Flush Rim Sink <input type="checkbox"/> Instantaneous Hot Water <input type="checkbox"/> Floor Drain <input type="checkbox"/> <input type="checkbox"/> Water Bottle Refill Station Other: <input type="text"/>	<b>MED / NON-MED GASES</b> (Quantity) Oxygen: <input type="text"/> Medical Air: <input type="text"/> Medical Vacuum: <input type="text"/> Nitrous Oxide: <input type="text"/> CO2: <input type="text"/> AGSS: <input type="text"/> Nitrogen: <input type="text"/> Laboratory Air: <input type="text"/> Laboratory Vacuum: <input type="text"/> Utility Compressed Air: <input type="text"/> Gas Remarks: <input type="text"/>
---	---	---

**Appendix 1B Minimum Room Requirements**

Room Name:

Program Number(s):

1.	W4.23	7.		13.		19.		25.		31.		37.		43.
2.		8.		14.		20.		26.		32.		38.		44.
3.		9.		15.		21.		27.		33.		39.		45.
4.		10.		16.		22.		28.		34.		40.		46.
5.		11.		17.		23.		29.		35.		41.		47.
6.		12.		18.		24.		30.		36.		42.		48.

**ARCHITECTURAL REQUIREMENTS**

<b>WALL AND CEILING</b> Wall Material: <input type="text" value="ARGB 1.2m AFF, GB above"/> Finish: <input type="text" value="PT"/> Ceiling Material: <input type="text" value="MMRGB"/> Finish: <input type="text" value="ECC"/>	<b>WALL PROTECTION</b> Type: <input type="text" value="RHIS"/> <input checked="" type="checkbox"/> Corner Guards <input type="checkbox"/> Hand Rails <input type="checkbox"/> Bed Bumper / Locator Height: <input type="text" value="2185 mm"/> <input type="checkbox"/> Crash Rails <input type="checkbox"/> Chair Rail	<b>GLAZING</b> <input type="checkbox"/> Interior Glazing	<b>FLOORING TYPES</b> Material: <input type="text" value="WSVF"/> Base: <input type="text" value="FCB"/>	<b>ROOM ACCESSORIES</b> <input type="checkbox"/> Coat Hooks <input type="checkbox"/> Ceiling Lift <input checked="" type="checkbox"/> Magnetic Whiteboard <input type="checkbox"/> Mirror <input type="checkbox"/> Infant Change Table <input type="checkbox"/> Privacy Curtain
---	--	---	---	---

- LEGEND:**
- WALL AND CEILING LEGEND:**
- AC Architectural Ceiling
  - ACT Acoustic Ceiling Tile
  - ACT-C Cleanroom
  - ARGB Abuse-Resistant Gypsum Board
  - GB Gypsum Board
  - IRGB Impact-Resistant Gypsum Board
  - KLCT Kitchen Lay-in Ceiling Tile
  - MMRGB Moisture and Mould-Resistant Gypsum Board
  - SACT Security Acoustic Ceiling Tile
- WALL FINISHES LEGEND:**
- EWC Epoxy Wall Coating
  - HPC High Performance Coating
  - PT Paint
- CEILING FINISHES LEGEND:**
- ECC Epoxy Ceiling Coating
  - HPC High Performance Coating
  - PF Prefinished
  - PT Paint
- WALL PROTECTION LEGEND:**
- ESRP Extruded Semi-Rigid PVCu Panel
  - FRL Fibre Reinforced Laminate
  - FRP Fibreglass Reinforced Plastic
  - PVV Protective Vinyl Wallcovering
  - RHIS Rigid High Impact Sheet
  - WSSP Wetwall Solid Surface Panel
  - WVV Wetroom Vinyl Wallcovering
- FLOOR FINISHES LEGEND:**
- CFS Concrete Floor Sealer
  - EFC Epoxy Floor Coating
  - PFC Polyurethane Floor Coating
  - RAF Rubber Athletic Flooring
  - RSF Rubber Sheet Flooring
  - SCF Seamless Cushioned Flooring
  - SDRF Static-Dissipative Rubber Sheet Flooring
  - SDVF Static-Dissipative Vinyl Sheet Flooring
  - VSF Vinyl Sheet Flooring
  - WSVF Wetroom Safety Vinyl Sheet Flooring
- FLOOR BASE LEGEND:**
- FCB Flash Cove Base
  - RB Rubber Base
  - SCF Seamless Cushioned Flooring

**DOORS**

Types:

Type	Qty	Size (mm)	Material	Finish	Side Lt.	Blinds	Protect.	Privacy Film	Function	Card Reader	Mag Lock	Auto Opener	Hold Open	Hinges	Accessory 1	Accessory 2	Accessory 3	Closer
C2	1	1830 x 2135	Solid Core	FRL	<input type="checkbox"/>	<input type="checkbox"/>	2 High	<input type="checkbox"/>	Storeroom	<input checked="" type="checkbox"/>	<input type="checkbox"/>	<input type="checkbox"/>	<input checked="" type="checkbox"/>	Butt Hinge	Astragal	Flush Bolt		Surface

Door Remarks:  Security Grille  Anti-barricade strategy

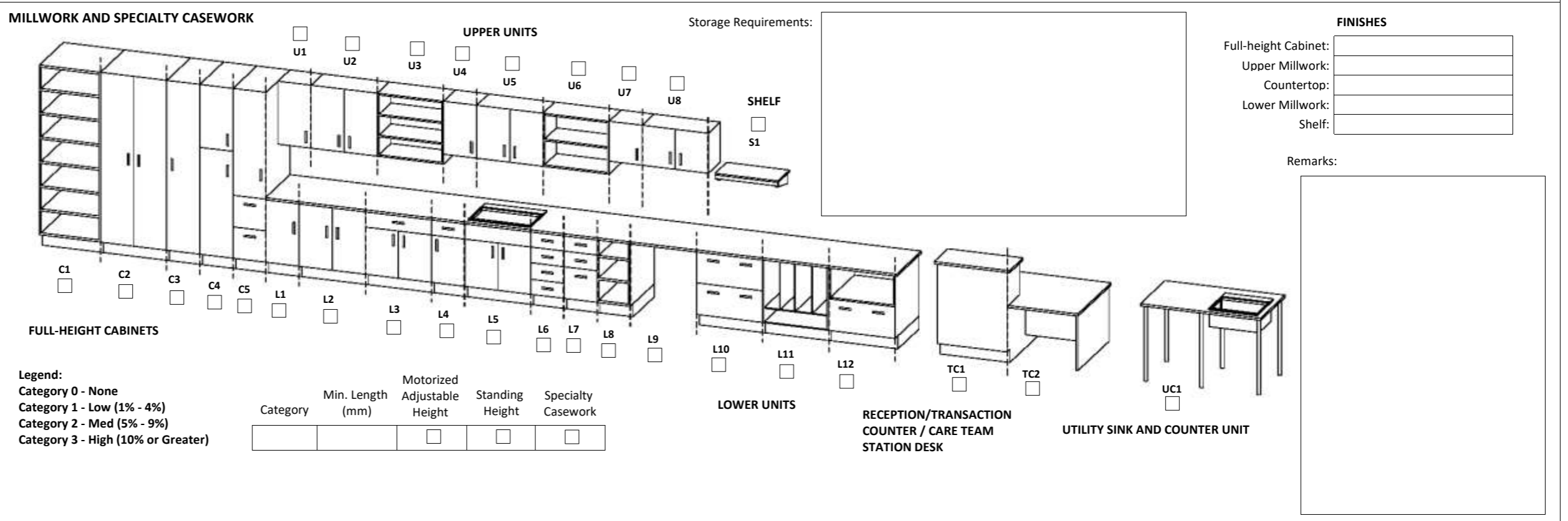

**MECHANICAL REQUIREMENTS**

<b>PLUMBING</b> (Quantity) Hand Hygiene Sink: <input type="text"/> Lavatory: <input type="text"/> Kitchen Sink: <input type="text"/> Seamless Kitchen Sink: <input type="text"/> Utility / Process Sink: <input type="text"/> Scrub Sink: <input type="text"/> Floor Sink: <input type="text"/> Plumbing Remarks: <input type="text"/>	Other Fixtures: <input type="checkbox"/> Shower <input type="checkbox"/> Eyewash Station <input type="checkbox"/> Tub <input type="checkbox"/> Eyewash/Shower Station <input type="checkbox"/> Ice Maker <input type="checkbox"/> Emergency Shower <input type="checkbox"/> Water Closet <input type="checkbox"/> Flush Rim Sink <input type="checkbox"/> Instantaneous Hot Water <input type="checkbox"/> Floor Drain <input type="checkbox"/> <input type="checkbox"/> Water Bottle Refill Station Other: <input type="text"/>	<b>MED / NON-MED GASES</b> (Quantity) Oxygen: <input type="text"/> Medical Air: <input type="text"/> Medical Vacuum: <input type="text"/> Nitrous Oxide: <input type="text"/> CO2: <input type="text"/> AGSS: <input type="text"/> Nitrogen: <input type="text"/> Laboratory Air: <input type="text"/> Laboratory Vacuum: <input type="text"/> Utility Compressed Air: <input type="text"/> Gas Remarks: <input type="text"/>
---	---	--



**Appendix 1B Minimum Room Requirements**

Room Name:

Program Number(s):

1. W2.04	7.	13.	19.	25.	31.	37.	43.
2.	8.	14.	20.	26.	32.	38.	44.
3.	9.	15.	21.	27.	33.	39.	45.
4.	10.	16.	22.	28.	34.	40.	46.
5.	11.	17.	23.	29.	35.	41.	47.
6.	12.	18.	24.	30.	36.	42.	48.

**ARCHITECTURAL REQUIREMENTS**

<b>WALL AND CEILING</b> Wall Material: <input type="text" value="ARGB 1.2m AFF, GB above"/> Finish: <input type="text" value="PT"/> Ceiling Material: <input type="text" value="MMRGB"/> Finish: <input type="text" value="ECC"/>	<b>WALL PROTECTION</b> Type: <input type="text" value="RHIS"/> <input checked="" type="checkbox"/> Corner Guards <input type="checkbox"/> Hand Rails <input type="checkbox"/> Bed Bumper / Locator Height: <input type="text" value="2185 mm"/> <input checked="" type="checkbox"/> Crash Rails <input type="checkbox"/> Chair Rail	<b>GLAZING</b> <input type="checkbox"/> Interior Glazing	<b>FLOORING TYPES</b> Material: <input type="text" value="WSVF"/> Base: <input type="text" value="FCB"/>	<b>ROOM ACCESSORIES</b> <input type="checkbox"/> Coat Hooks <input type="checkbox"/> Ceiling Lift <input checked="" type="checkbox"/> Magnetic Whiteboard <input type="checkbox"/> Mirror <input type="checkbox"/> Infant Change Table <input type="checkbox"/> Privacy Curtain
---	---	---	---	---

- LEGEND:**
- WALL AND CEILING LEGEND:**
- AC Architectural Ceiling
  - ACT Acoustic Ceiling Tile
  - ACT-C Cleanroom
  - ARGB Abuse-Resistant Gypsum Board
  - GB Gypsum Board
  - IRGB Impact-Resistant Gypsum Board
  - KLCT Kitchen Lay-in Ceiling Tile
  - MMRGB Moisture and Mould-Resistant Gypsum Board
  - SACT Security Acoustic Ceiling Tile
- WALL FINISHES LEGEND:**
- EWC Epoxy Wall Coating
  - HPC High Performance Coating
  - PT Paint
- CEILING FINISHES LEGEND:**
- ECC Epoxy Ceiling Coating
  - HPC High Performance Coating
  - PF Prefinished
  - PT Paint
- WALL PROTECTION LEGEND:**
- ESRP Extruded Semi-Rigid PVCu Panel
  - FRL Fibre Reinforced Laminate
  - FRP Fibreglass Reinforced Plastic
  - PVV Protective Vinyl Wallcovering
  - RHIS Rigid High Impact Sheet
  - WSSP Wetwall Solid Surface Panel
  - WVV Wetroom Vinyl Wallcovering
- FLOOR FINISHES LEGEND:**
- CFS Concrete Floor Sealer
  - EFC Epoxy Floor Coating
  - PFC Polyurethane Floor Coating
  - RAF Rubber Athletic Flooring
  - RSF Rubber Sheet Flooring
  - SCF Seamless Cushioned Flooring
  - SDRF Static-Dissipative Rubber Sheet Flooring
  - SDVF Static-Dissipative Vinyl Sheet Flooring
  - VSF Vinyl Sheet Flooring
  - WSVF Wetroom Safety Vinyl Sheet Flooring
- FLOOR BASE LEGEND:**
- FCB Flash Cove Base
  - RB Rubber Base
  - SCF Seamless Cushioned Flooring

**DOORS**

Types:

Type	Qty	Size (mm)	Material	Finish	Side Lt.	Blinds	Protect.	Privacy Film	Function	Card Reader	Mag Lock	Auto Opener	Hold Open	Hinges	Accessory 1	Accessory 2	Accessory 3	Closer
C2	1	1830 x 2135	Solid Core	FRL	<input type="checkbox"/>	<input type="checkbox"/>	2 High	<input type="checkbox"/>	Storeroom	<input checked="" type="checkbox"/>	<input type="checkbox"/>	<input checked="" type="checkbox"/>	<input checked="" type="checkbox"/>	Butt Hinge	Astragal	Flush Bolt	Elec. Strike	Surface

Door Remarks:  Security Grille  Anti-barricade strategy



**MECHANICAL REQUIREMENTS**

<b>PLUMBING</b> (Quantity) Hand Hygiene Sink: <input type="text" value="1"/> Lavatory: <input type="text"/> Kitchen Sink: <input type="text"/> Seamless Kitchen Sink: <input type="text"/> Utility / Process Sink: <input type="text"/> Scrub Sink: <input type="text"/> Floor Sink: <input type="text" value="1"/> Plumbing Remarks: <input type="text"/>	Other Fixtures: <input type="checkbox"/> Shower <input type="checkbox"/> Eyewash Station <input type="checkbox"/> Tub <input type="checkbox"/> Eyewash/Shower Station <input type="checkbox"/> Ice Maker <input type="checkbox"/> Emergency Shower <input type="checkbox"/> Water Closet <input checked="" type="checkbox"/> Floor Drain <input type="checkbox"/> Instantaneous Hot Water <input type="checkbox"/> Water Bottle Refill Station Other: <input type="text"/>	<b>MED / NON-MED GASES</b> (Quantity) Oxygen: <input type="text"/> Medical Air: <input type="text"/> Medical Vacuum: <input type="text"/> Nitrous Oxide: <input type="text"/> CO2: <input type="text"/> AGSS: <input type="text"/> Nitrogen: <input type="text"/> Laboratory Air: <input type="text"/> Laboratory Vacuum: <input type="text"/> Utility Compressed Air: <input type="text"/> Gas Remarks: <input type="text"/>
---	--	---

**Appendix 1B Minimum Room Requirements**

Room Name:

Program Number(s):

1. W3.06	7.	13.	19.	25.	31.	37.	43.
2.	8.	14.	20.	26.	32.	38.	44.
3.	9.	15.	21.	27.	33.	39.	45.
4.	10.	16.	22.	28.	34.	40.	46.
5.	11.	17.	23.	29.	35.	41.	47.
6.	12.	18.	24.	30.	36.	42.	48.

**ARCHITECTURAL REQUIREMENTS**

<b>WALL AND CEILING</b> Wall Material: <input type="text" value="GB"/> Finish: <input type="text" value="PT"/> Ceiling Material: <input type="text" value="ACT"/> Finish: <input type="text" value="PF"/>	<b>WALL PROTECTION</b> Type: <input type="text"/> Height: <input type="text"/> <input checked="" type="checkbox"/> Corner Guards <input type="checkbox"/> Hand Rails <input type="checkbox"/> Bed Bumper / Locator <input type="checkbox"/> Crash Rails <input type="checkbox"/> Chair Rail	<b>GLAZING</b> <input type="checkbox"/> Interior Glazing	<b>FLOORING TYPES</b> Material: <input type="text" value="VSF"/> Base: <input type="text" value="FCB"/>	<b>ROOM ACCESSORIES</b> <input type="checkbox"/> Coat Hooks <input type="checkbox"/> Ceiling Lift <input checked="" type="checkbox"/> Magnetic Whiteboard <input type="checkbox"/> Mirror <input type="checkbox"/> Infant Change Table <input type="checkbox"/> Privacy Curtain
---	--	---	--	---

- LEGEND:**
- WALL AND CEILING LEGEND:**
- AC Architectural Ceiling
  - ACT Acoustic Ceiling Tile
  - ACT-C Cleanroom
  - ARGB Abuse-Resistant Gypsum Board
  - GB Gypsum Board
  - IRGB Impact-Resistant Gypsum Board
  - KLCT Kitchen Lay-in Ceiling Tile
  - MMRGB Moisture and Mould-Resistant Gypsum Board
  - SACT Security Acoustic Ceiling Tile
- WALL FINISHES LEGEND:**
- EWC Epoxy Wall Coating
  - HPC High Performance Coating
  - PT Paint
- CEILING FINISHES LEGEND:**
- ECC Epoxy Ceiling Coating
  - HPC High Performance Coating
  - PF Prefinished
  - PT Paint
- WALL PROTECTION LEGEND:**
- ESRP Extruded Semi-Rigid PVCu Panel
  - FRL Fibre Reinforced Laminate
  - FRP Fibreglass Reinforced Plastic
  - PVV Protective Vinyl Wallcovering
  - RHIS Rigid High Impact Sheet
  - WSSP Wetwall Solid Surface Panel
  - WVV Wetroom Vinyl Wallcovering
- FLOOR FINISHES LEGEND:**
- CFS Concrete Floor Sealer
  - EFC Epoxy Floor Coating
  - PFC Polyurethane Floor Coating
  - RAF Rubber Athletic Flooring
  - RSF Rubber Sheet Flooring
  - SCF Seamless Cushioned Flooring
  - SDRF Static-Dissipative Rubber Sheet Flooring
  - SDVF Static-Dissipative Vinyl Sheet Flooring
  - VSF Vinyl Sheet Flooring
  - WSVF Wetroom Safety Vinyl Sheet Flooring
- FLOOR BASE LEGEND:**
- FCB Flash Cove Base
  - RB Rubber Base
  - SCF Seamless Cushioned Flooring

**DOORS**

Types:

Type	Qty	Size (mm)	Material	Finish	Side Lt	Blinds	Protect	Privacy Film	Function	Card Reader	Mag Lock	Auto Opener	Hold Open	Hinges	Accessory 1	Accessory 2	Accessory 3	Closer
A	1	915 x 2135	Solid Core	FRL	<input checked="" type="checkbox"/>	<input type="checkbox"/>	2 High	<input type="checkbox"/>	Storeroom	<input checked="" type="checkbox"/>	<input type="checkbox"/>	<input type="checkbox"/>	<input checked="" type="checkbox"/>	Butt Hinge				Surface

Door Remarks:  Security Grille  Anti-barricade strategy

**MILLWORK AND SPECIALTY CASEWORK**

Storage Requirements:

**UPPER UNITS** (U1-U8)  U1  U2  U3  U4  U5  U6  U7  U8

**LOWER UNITS** (L1-L9)  L1  L2  L3  L4  L5  L6  L7  L8  L9

**RECEPTION/TRANSACTION COUNTER / CARE TEAM STATION DESK** (TC1, TC2)  TC1  TC2

**UTILITY SINK AND COUNTER UNIT** (UC1)  UC1

**FINISHES**

Full-height Cabinet:

Upper Millwork:

Countertop:

Lower Millwork:

Shelf:

Remarks:

Category	Min. Length (mm)	Motorized Adjustable Height	Standing Height	Specialty Casework
3	13500	<input type="checkbox"/>	<input checked="" type="checkbox"/>	<input type="checkbox"/>

**MECHANICAL REQUIREMENTS**

<b>PLUMBING</b> (Quantity) Hand Hygiene Sink: <input type="text"/> Lavatory: <input type="text"/> Kitchen Sink: <input type="text"/> Seamless Kitchen Sink: <input type="text"/> Utility / Process Sink: <input type="text"/> Scrub Sink: <input type="text"/> Floor Sink: <input type="text"/> Plumbing Remarks: <input type="text"/>	Other Fixtures: <input type="checkbox"/> Shower <input type="checkbox"/> Tub <input type="checkbox"/> Ice Maker <input type="checkbox"/> Water Closet <input type="checkbox"/> Instantaneous Hot Water <input type="checkbox"/> Ewwash Station <input type="checkbox"/> Ewwash/Shower Station <input type="checkbox"/> Emergency Shower <input type="checkbox"/> Flush Rim Sink <input type="checkbox"/> Floor Drain <input type="checkbox"/> Water Bottle Refill Station Other: <input type="text"/>	<b>MED / NON-MED GASES</b> (Quantity) Oxygen: <input type="text"/> Medical Air: <input type="text"/> Medical Vacuum: <input type="text"/> Nitrous Oxide: <input type="text"/> CO2: <input type="text"/> AGSS: <input type="text"/> Nitrogen: <input type="text"/> Laboratory Air: <input type="text"/> Laboratory Vacuum: <input type="text"/> Utility Compressed Air: <input type="text"/> Gas Remarks: <input type="text"/>
--	--	---

**Appendix 1B Minimum Room Requirements**

Room Name:

Program Number(s):

1. W1.09	7.	13.	19.	25.	31.	37.	43.
2.	8.	14.	20.	26.	32.	38.	44.
3.	9.	15.	21.	27.	33.	39.	45.
4.	10.	16.	22.	28.	34.	40.	46.
5.	11.	17.	23.	29.	35.	41.	47.
6.	12.	18.	24.	30.	36.	42.	48.

**ARCHITECTURAL REQUIREMENTS**

<b>WALL AND CEILING</b> Wall Material: <input type="text" value="ARGB 1.2m AFF, GB above"/> Finish: <input type="text" value="PT"/> Ceiling Material: <input type="text" value="ACT"/> Finish: <input type="text" value="PF"/>	<b>WALL PROTECTION</b> Type: <input type="text" value="ESRP"/> <input checked="" type="checkbox"/> Corner Guards <input type="checkbox"/> Hand Rails <input type="checkbox"/> Bed Bumper / Locator Height: <input type="text" value="2185 mm"/> <input checked="" type="checkbox"/> Crash Rails <input type="checkbox"/> Chair Rail	<b>GLAZING</b> <input type="checkbox"/> Interior Glazing	<b>FLOORING TYPES</b> Material: <input type="text" value="EFC"/> Base: <input type="text" value="FCB"/>	<b>ROOM ACCESSORIES</b> <input type="checkbox"/> Coat Hooks <input type="checkbox"/> Ceiling Lift <input type="checkbox"/> Magnetic Whiteboard <input type="checkbox"/> Mirror <input type="checkbox"/> Infant Change Table <input type="checkbox"/> Privacy Curtain
--	---	---	--	--

- LEGEND:**
- WALL AND CEILING LEGEND:**
- AC Architectural Ceiling
  - ACT Acoustic Ceiling Tile
  - ACT-C Cleanroom
  - ARGB Abuse-Resistant Gypsum Board
  - GB Gypsum Board
  - IRGB Impact-Resistant Gypsum Board
  - KLCT Kitchen Lay-in Ceiling Tile
  - MMRGB Moisture and Mould-Resistant Gypsum Board
  - SACT Security Acoustic Ceiling Tile
- WALL FINISHES LEGEND:**
- EWC Epoxy Wall Coating
  - HPC High Performance Coating
  - PT Paint
- CEILING FINISHES LEGEND:**
- ECC Epoxy Ceiling Coating
  - HPC High Performance Coating
  - PF Prefinished
  - PT Paint
- WALL PROTECTION LEGEND:**
- ESRP Extruded Semi-Rigid PVCu Panel
  - FRL Fibre Reinforced Laminate
  - FRP Fibreglass Reinforced Plastic
  - PVV Protective Vinyl Wallcovering
  - RHIS Rigid High Impact Sheet
  - WSSP Wetwall Solid Surface Panel
  - WVV Wetroom Vinyl Wallcovering
- FLOOR FINISHES LEGEND:**
- CFS Concrete Floor Sealer
  - EFC Epoxy Floor Coating
  - PFC Polyurethane Floor Coating
  - RAF Rubber Athletic Flooring
  - RSF Rubber Sheet Flooring
  - SCF Seamless Cushioned Flooring
  - SDRF Static-Dissipative Rubber Sheet Flooring
  - SDVF Static-Dissipative Vinyl Sheet Flooring
  - VSF Vinyl Sheet Flooring
  - WSVF Wetroom Safety Vinyl Sheet Flooring
- FLOOR BASE LEGEND:**
- FCB Flash Cove Base
  - RB Rubber Base
  - SCF Seamless Cushioned Flooring

**DOORS**

Types:

Type	Qty	Size (mm)	Material	Finish	Side Lt.	Blinds	Protect.	Privacy Film	Function	Card Reader	Mag Lock	Auto Opener	Hold Open	Hinges	Accessory 1	Accessory 2	Accessory 3	Closer
A	1	1065 x 2135	Solid Core	FRL	<input type="checkbox"/>	<input type="checkbox"/>	2 High	<input type="checkbox"/>	Storeroom	<input checked="" type="checkbox"/>	<input type="checkbox"/>	<input type="checkbox"/>	<input checked="" type="checkbox"/>	Butt Hinge				Surface

Door Remarks:  Security Grille  Anti-barricade strategy

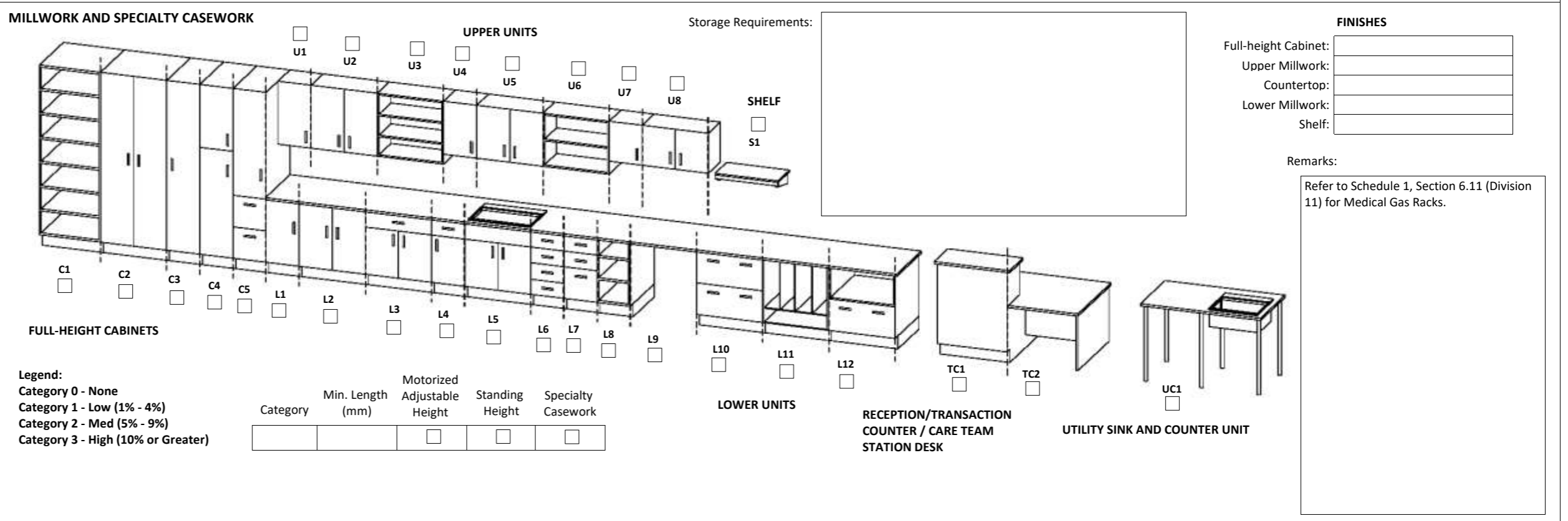

**MECHANICAL REQUIREMENTS**

<b>PLUMBING</b> (Quantity) Hand Hygiene Sink: <input type="text"/> Lavatory: <input type="text"/> Kitchen Sink: <input type="text"/> Seamless Kitchen Sink: <input type="text"/> Utility / Process Sink: <input type="text"/> Scrub Sink: <input type="text"/> Floor Sink: <input type="text"/> Plumbing Remarks: <input type="text"/>	Other Fixtures: <input type="checkbox"/> Shower <input type="checkbox"/> Eyewash Station <input type="checkbox"/> Tub <input type="checkbox"/> Eyewash/Shower Station <input type="checkbox"/> Ice Maker <input type="checkbox"/> Emergency Shower <input type="checkbox"/> Water Closet <input type="checkbox"/> Flush Rim Sink <input type="checkbox"/> Instantaneous Hot Water <input type="checkbox"/> Floor Drain <input type="checkbox"/> <input type="checkbox"/> Water Bottle Refill Station Other: <input type="text"/>	<b>MED / NON-MED GASES</b> (Quantity) Oxygen: <input type="text"/> Medical Air: <input type="text"/> Medical Vacuum: <input type="text"/> Nitrous Oxide: <input type="text"/> CO2: <input type="text"/> AGSS: <input type="text"/> Nitrogen: <input type="text"/> Laboratory Air: <input type="text"/> Laboratory Vacuum: <input type="text"/> Utility Compressed Air: <input type="text"/> Gas Remarks: <input type="text"/>
---	---	---



**Appendix 1B Minimum Room Requirements**

Room Name:

Program Number(s):

1. W2.07	7.	13.	19.	25.	31.	37.	43.
2.	8.	14.	20.	26.	32.	38.	44.
3.	9.	15.	21.	27.	33.	39.	45.
4.	10.	16.	22.	28.	34.	40.	46.
5.	11.	17.	23.	29.	35.	41.	47.
6.	12.	18.	24.	30.	36.	42.	48.

**ARCHITECTURAL REQUIREMENTS**

<b>WALL AND CEILING</b> Wall Material: <input type="text" value="ARGB 1.2m AFF, GB above"/> Finish: <input type="text" value="PT"/> Ceiling Material: <input type="text" value="ACT"/> Finish: <input type="text" value="PF"/>	<b>WALL PROTECTION</b> Type: <input type="text" value="ESRP"/> <input checked="" type="checkbox"/> Corner Guards <input type="checkbox"/> Hand Rails <input type="checkbox"/> Bed Bumper / Locator Height: <input type="text" value="2185 mm"/> <input checked="" type="checkbox"/> Crash Rails <input type="checkbox"/> Chair Rail	<b>GLAZING</b> <input type="checkbox"/> Interior Glazing	<b>FLOORING TYPES</b> Material: <input type="text" value="WSVF"/> Base: <input type="text" value="FCB"/>	<b>ROOM ACCESSORIES</b> <input type="checkbox"/> Coat Hooks <input type="checkbox"/> Ceiling Lift <input checked="" type="checkbox"/> Magnetic Whiteboard <input type="checkbox"/> Mirror <input type="checkbox"/> Infant Change Table <input type="checkbox"/> Privacy Curtain
--	---	---	---	---

- LEGEND:**
- WALL AND CEILING LEGEND:**
- AC Architectural Ceiling
  - ACT Acoustic Ceiling Tile
  - ACT-C Cleanroom
  - ARGB Abuse-Resistant Gypsum Board
  - GB Gypsum Board
  - IRGB Impact-Resistant Gypsum Board
  - KLCT Kitchen Lay-in Ceiling Tile
  - MMRGB Moisture and Mould-Resistant Gypsum Board
  - SACT Security Acoustic Ceiling Tile
- WALL FINISHES LEGEND:**
- EWC Epoxy Wall Coating
  - HPC High Performance Coating
  - PT Paint
- CEILING FINISHES LEGEND:**
- ECC Epoxy Ceiling Coating
  - HPC High Performance Coating
  - PF Prefinished
  - PT Paint
- WALL PROTECTION LEGEND:**
- ESRP Extruded Semi-Rigid PVCu Panel
  - FRL Fibre Reinforced Laminate
  - FRP Fibreglass Reinforced Plastic
  - PVV Protective Vinyl Wallcovering
  - RHIS Rigid High Impact Sheet
  - WSSP Wetwall Solid Surface Panel
  - WVV Wetroom Vinyl Wallcovering
- FLOOR FINISHES LEGEND:**
- CFS Concrete Floor Sealer
  - EFC Epoxy Floor Coating
  - PFC Polyurethane Floor Coating
  - RAF Rubber Athletic Flooring
  - RSF Rubber Sheet Flooring
  - SCF Seamless Cushioned Flooring
  - SDRF Static-Dissipative Rubber Sheet Flooring
  - SDVF Static-Dissipative Vinyl Sheet Flooring
  - VSF Vinyl Sheet Flooring
  - WSVF Wetroom Safety Vinyl Sheet Flooring
- FLOOR BASE LEGEND:**
- FCB Flash Cove Base
  - RB Rubber Base
  - SCF Seamless Cushioned Flooring

**DOORS**

Types:

Type	Qty	Size (mm)	Material	Finish	Side Lt.	Blinds	Protect.	Privacy Film	Function	Card Reader	Mag Lock	Auto Opener	Hold Open	Hinges	Accessory 1	Accessory 2	Accessory 3	Closer
C2	2	1830 x 2135	Hollow Metal	Paint	<input type="checkbox"/>	<input type="checkbox"/>	2 High	<input type="checkbox"/>	Storeroom	<input checked="" type="checkbox"/>	<input type="checkbox"/>	<input checked="" type="checkbox"/>	<input checked="" type="checkbox"/>	Butt Hinge	Astragal	Flush Bolt	Elec. Strike	Surface

Door Remarks:  Security Grille  Anti-barricade strategy



**MECHANICAL REQUIREMENTS**

<b>PLUMBING</b> (Quantity) Hand Hygiene Sink: <input type="text" value="1"/> Lavatory: <input type="text"/> Kitchen Sink: <input type="text"/> Seamless Kitchen Sink: <input type="text"/> Utility / Process Sink: <input type="text"/> Scrub Sink: <input type="text"/> Floor Sink: <input type="text"/> Plumbing Remarks: <input type="text"/>	Other Fixtures: <input type="checkbox"/> Shower <input type="checkbox"/> Eyewash Station <input type="checkbox"/> Tub <input type="checkbox"/> Eyewash/Shower Station <input type="checkbox"/> Ice Maker <input type="checkbox"/> Emergency Shower <input type="checkbox"/> Water Closet <input type="checkbox"/> Flush Rim Sink <input type="checkbox"/> Instantaneous Hot Water <input type="checkbox"/> Floor Drain <input type="checkbox"/> <input type="checkbox"/> Water Bottle Refill Station Other: <input type="text"/>	<b>MED / NON-MED GASES</b> (Quantity) Oxygen: <input type="text"/> Medical Air: <input type="text"/> Medical Vacuum: <input type="text"/> Nitrous Oxide: <input type="text"/> CO2: <input type="text"/> AGSS: <input type="text"/> Nitrogen: <input type="text"/> Laboratory Air: <input type="text"/> Laboratory Vacuum: <input type="text"/> Utility Compressed Air: <input type="text"/> Gas Remarks: <input type="text"/>
---	---	---

**Appendix 1B Minimum Room Requirements**

Room Name:

Program Number(s):

1.	W1.02	7.		13.		19.		25.		31.		37.		43.
2.		8.		14.		20.		26.		32.		38.		44.
3.		9.		15.		21.		27.		33.		39.		45.
4.		10.		16.		22.		28.		34.		40.		46.
5.		11.		17.		23.		29.		35.		41.		47.
6.		12.		18.		24.		30.		36.		42.		48.

**ARCHITECTURAL REQUIREMENTS**

<b>WALL AND CEILING</b> Wall Material: <input type="text" value="MMRGB"/> Finish: <input type="text" value="PT"/> Ceiling Material: <input type="text" value="ACT"/> Finish: <input type="text" value="PF"/>		<b>WALL PROTECTION</b> Type: <input type="text" value="ESRP"/> <input checked="" type="checkbox"/> Corner Guards <input type="checkbox"/> Hand Rails <input type="checkbox"/> Bed Bumper / Locator Height: <input type="text" value="2185 mm"/> <input checked="" type="checkbox"/> Crash Rails <input type="checkbox"/> Chair Rail		<b>GLAZING</b> <input type="checkbox"/> Interior Glazing		<b>FLOORING TYPES</b> Material: <input type="text" value="RSF"/> Base: <input type="text" value="FCB"/>		<b>ROOM ACCESSORIES</b> <input type="checkbox"/> Coat Hooks <input type="checkbox"/> Ceiling Lift <input checked="" type="checkbox"/> Magnetic Whiteboard <input type="checkbox"/> Mirror <input type="checkbox"/> Infant Change Table <input type="checkbox"/> Privacy Curtain	
--	--	---	--	---	--	--	--	---	--

- LEGEND:**
- WALL AND CEILING LEGEND:**
- AC Architectural Ceiling
  - ACT Acoustic Ceiling Tile
  - ACT-C Cleanroom
  - ARGB Abuse-Resistant Gypsum Board
  - GB Gypsum Board
  - IRGB Impact-Resistant Gypsum Board
  - KLCT Kitchen Lay-in Ceiling Tile
  - MMRGB Moisture and Mould-Resistant Gypsum Board
  - SACT Security Acoustic Ceiling Tile
- WALL FINISHES LEGEND:**
- EWC Epoxy Wall Coating
  - HPC High Performance Coating
  - PT Paint
- CEILING FINISHES LEGEND:**
- ECC Epoxy Ceiling Coating
  - HPC High Performance Coating
  - PF Prefinished
  - PT Paint
- WALL PROTECTION LEGEND:**
- ESRP Extruded Semi-Rigid PVCu Panel
  - FRL Fibre Reinforced Laminate
  - FRP Fibreglass Reinforced Plastic
  - PVV Protective Vinyl Wallcovering
  - RHIS Rigid High Impact Sheet
  - WSSP Wetwall Solid Surface Panel
  - WVV Wetroom Vinyl Wallcovering
- FLOOR FINISHES LEGEND:**
- CFS Concrete Floor Sealer
  - EFC Epoxy Floor Coating
  - PFC Polyurethane Floor Coating
  - RAF Rubber Athletic Flooring
  - RSF Rubber Sheet Flooring
  - SCF Seamless Cushioned Flooring
  - SDRF Static-Dissipative Rubber Sheet Flooring
  - SDVF Static-Dissipative Vinyl Sheet Flooring
  - VSF Vinyl Sheet Flooring
  - WSVF Wetroom Safety Vinyl Sheet Flooring
- FLOOR BASE LEGEND:**
- FCB Flash Cove Base
  - RB Rubber Base
  - SCF Seamless Cushioned Flooring

**DOORS**

Types:

Type	Qty	Size (mm)	Material	Finish	Side Lt.	Blinds	Protect.	Privacy Film	Function	Card Reader	Mag Lock	Auto Opener	Hold Open	Hinges	Accessory 1	Accessory 2	Accessory 3	Closer
A2	2	1830 x 2135	Hollow Metal	Paint	<input type="checkbox"/>	<input type="checkbox"/>		<input type="checkbox"/>	Storeroom	<input checked="" type="checkbox"/>	<input type="checkbox"/>	<input checked="" type="checkbox"/>	<input checked="" type="checkbox"/>	Cont. Swing Clear	Astragal	Flush Bolt	Elec. Strike	Surface

Door Remarks:  Security Grille  Anti-barricade strategy



**MECHANICAL REQUIREMENTS**

<b>PLUMBING</b> (Quantity) Hand Hygiene Sink: <input type="text" value="1"/> Lavatory: <input type="text"/> Kitchen Sink: <input type="text"/> Seamless Kitchen Sink: <input type="text"/> Utility / Process Sink: <input type="text"/> Scrub Sink: <input type="text"/> Floor Sink: <input type="text"/> Plumbing Remarks: <input type="text"/>		Other Fixtures: <input type="checkbox"/> Shower <input type="checkbox"/> Tub <input type="checkbox"/> Ice Maker <input type="checkbox"/> Water Closet <input type="checkbox"/> Instantaneous Hot Water <input type="checkbox"/> Eyewash Station <input type="checkbox"/> Eyewash/Shower Station <input type="checkbox"/> Emergency Shower <input type="checkbox"/> Flush Rim Sink <input type="checkbox"/> Floor Drain <input type="checkbox"/> Water Bottle Refill Station Other: <input type="text"/>		<b>MED / NON-MED GASES</b> (Quantity) Oxygen: <input type="text"/> Medical Air: <input type="text"/> Medical Vacuum: <input type="text"/> Nitrous Oxide: <input type="text"/> CO2: <input type="text"/> AGSS: <input type="text"/> Nitrogen: <input type="text"/> Laboratory Air: <input type="text"/> Laboratory Vacuum: <input type="text"/> Utility Compressed Air: <input type="text"/> Gas Remarks: <input type="text"/>	
--	--	--	--	---	--

**Appendix 1B Minimum Room Requirements**

Room Name:

Program Number(s):

1. W2.08	7.	13.	19.	25.	31.	37.	43.
2.	8.	14.	20.	26.	32.	38.	44.
3.	9.	15.	21.	27.	33.	39.	45.
4.	10.	16.	22.	28.	34.	40.	46.
5.	11.	17.	23.	29.	35.	41.	47.
6.	12.	18.	24.	30.	36.	42.	48.

**ARCHITECTURAL REQUIREMENTS**

<b>WALL AND CEILING</b> Wall Material: <input type="text" value="ARGB 1.2m AFF, GB above"/> Finish: <input type="text" value="PT"/> Ceiling Material: <input type="text" value="ACT"/> Finish: <input type="text" value="PF"/>	<b>WALL PROTECTION</b> Type: <input type="text" value="ESRP"/> <input checked="" type="checkbox"/> Corner Guards <input type="checkbox"/> Hand Rails <input type="checkbox"/> Bed Bumper / Locator Height: <input type="text" value="2185 mm"/> <input type="checkbox"/> Crash Rails <input type="checkbox"/> Chair Rail	<b>GLAZING</b> <input type="checkbox"/> Interior Glazing	<b>FLOORING TYPES</b> Material: <input type="text" value="EFC"/> Base: <input type="text" value="FCB"/>	<b>ROOM ACCESSORIES</b> <input type="checkbox"/> Coat Hooks <input type="checkbox"/> Ceiling Lift <input checked="" type="checkbox"/> Magnetic Whiteboard <input type="checkbox"/> Mirror <input type="checkbox"/> Infant Change Table <input type="checkbox"/> Privacy Curtain
--	--	---	--	---

- LEGEND:**
- WALL AND CEILING LEGEND:**
- AC Architectural Ceiling
  - ACT Acoustic Ceiling Tile
  - ACT-C Cleanroom
  - ARGB Abuse-Resistant Gypsum Board
  - GB Gypsum Board
  - IRGB Impact-Resistant Gypsum Board
  - KLCT Kitchen Lay-in Ceiling Tile
  - MMRGB Moisture and Mould-Resistant Gypsum Board
  - SACT Security Acoustic Ceiling Tile
- WALL FINISHES LEGEND:**
- EWC Epoxy Wall Coating
  - HPC High Performance Coating
  - PT Paint
- CEILING FINISHES LEGEND:**
- ECC Epoxy Ceiling Coating
  - HPC High Performance Coating
  - PF Prefinished
  - PT Paint
- WALL PROTECTION LEGEND:**
- ESRP Extruded Semi-Rigid PVCu Panel
  - FRL Fibre Reinforced Laminate
  - FRP Fibreglass Reinforced Plastic
  - PVV Protective Vinyl Wallcovering
  - RHIS Rigid High Impact Sheet
  - WSSP Wetwall Solid Surface Panel
  - WVV Wetroom Vinyl Wallcovering
- FLOOR FINISHES LEGEND:**
- CFS Concrete Floor Sealer
  - EFC Epoxy Floor Coating
  - PFC Polyurethane Floor Coating
  - RAF Rubber Athletic Flooring
  - RSF Rubber Sheet Flooring
  - SCF Seamless Cushioned Flooring
  - SDRF Static-Dissipative Rubber Sheet Flooring
  - SDVF Static-Dissipative Vinyl Sheet Flooring
  - VSF Vinyl Sheet Flooring
  - WSVF Wetroom Safety Vinyl Sheet Flooring
- FLOOR BASE LEGEND:**
- FCB Flash Cove Base
  - RB Rubber Base
  - SCF Seamless Cushioned Flooring

**DOORS**

Types:

Type	Qty	Size (mm)	Material	Finish	Side Lt.	Blinds	Protect.	Privacy Film	Function	Card Reader	Mag Lock	Auto Opener	Hold Open	Hinges	Accessory 1	Accessory 2	Accessory 3	Closer
A2	1	1830 x 2135	Hollow Metal	Paint	<input type="checkbox"/>	<input type="checkbox"/>		<input type="checkbox"/>	Storeroom	<input checked="" type="checkbox"/>	<input type="checkbox"/>	<input checked="" type="checkbox"/>	<input checked="" type="checkbox"/>	Cont. Swing Clear	Astragal	Flush Bolt	Elec. Strike	Surface

Door Remarks:  Security Grille  Anti-barricade strategy

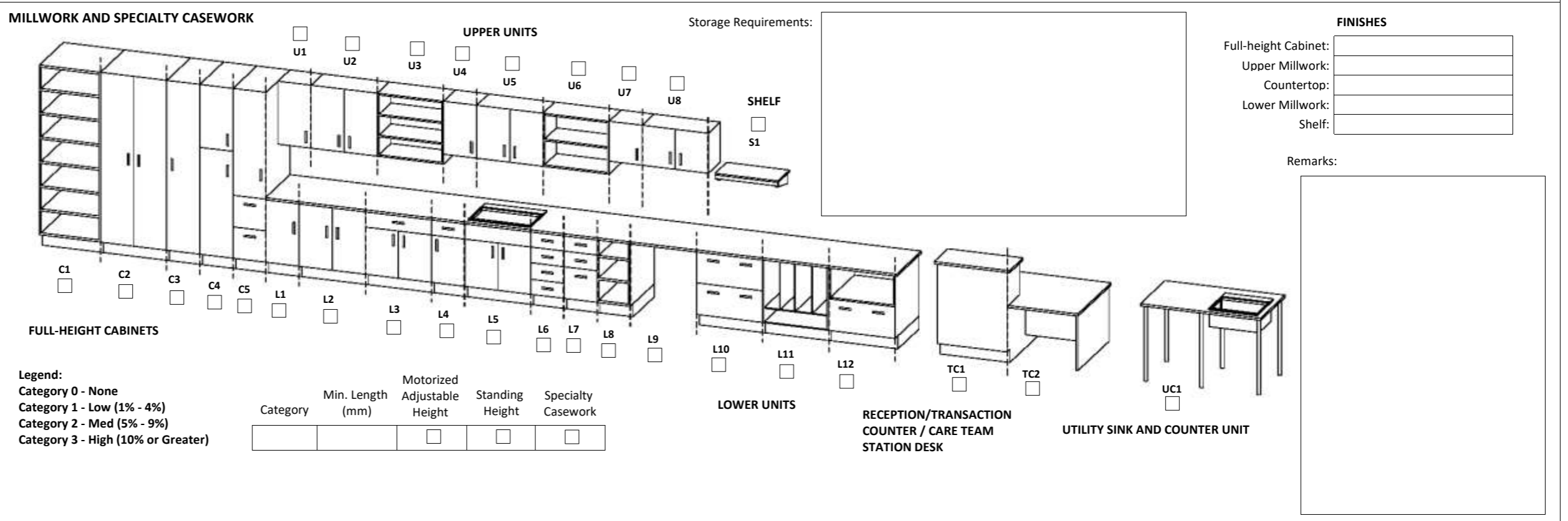

**MECHANICAL REQUIREMENTS**

<b>PLUMBING</b> (Quantity) Hand Hygiene Sink: <input type="text" value="1"/> Lavatory: <input type="text"/> Kitchen Sink: <input type="text"/> Seamless Kitchen Sink: <input type="text"/> Utility / Process Sink: <input type="text"/> Scrub Sink: <input type="text"/> Floor Sink: <input type="text"/> Plumbing Remarks: <input type="text"/>	Other Fixtures: <input type="checkbox"/> Shower <input type="checkbox"/> Tub <input type="checkbox"/> Ice Maker <input type="checkbox"/> Water Closet <input type="checkbox"/> Instantaneous Hot Water <input type="checkbox"/> Eyewash Station <input type="checkbox"/> Eyewash/Shower Station <input type="checkbox"/> Emergency Shower <input type="checkbox"/> Flush Rim Sink <input type="checkbox"/> Floor Drain <input type="checkbox"/> Water Bottle Refill Station Other: <input type="text"/>	<b>MED / NON-MED GASES</b> (Quantity) Oxygen: <input type="text"/> Medical Air: <input type="text"/> Medical Vacuum: <input type="text"/> Nitrous Oxide: <input type="text"/> CO2: <input type="text"/> AGSS: <input type="text"/> Nitrogen: <input type="text"/> Laboratory Air: <input type="text"/> Laboratory Vacuum: <input type="text"/> Utility Compressed Air: <input type="text"/> Gas Remarks: <input type="text"/>
--	--	---



**Appendix 1B Minimum Room Requirements**

Room Name:

Program Number(s):

1.	W2.03	7.		13.		19.		25.		31.		37.		43.
2.		8.		14.		20.		26.		32.		38.		44.
3.		9.		15.		21.		27.		33.		39.		45.
4.		10.		16.		22.		28.		34.		40.		46.
5.		11.		17.		23.		29.		35.		41.		47.
6.		12.		18.		24.		30.		36.		42.		48.

**ARCHITECTURAL REQUIREMENTS**

<b>WALL AND CEILING</b> Wall Material: <input type="text" value="ARGB 1.2m AFF, GB above"/> Finish: <input type="text" value="PT"/> Ceiling Material: <input type="text" value="ACT"/> Finish: <input type="text" value="PF"/>		<b>WALL PROTECTION</b> Type: <input type="text" value="PVW"/> <input checked="" type="checkbox"/> Corner Guards <input type="checkbox"/> Hand Rails <input type="checkbox"/> Bed Bumper / Locator Height: <input type="text" value="2185 mm"/> <input checked="" type="checkbox"/> Crash Rails <input type="checkbox"/> Chair Rail			<b>GLAZING</b> <input type="checkbox"/> Interior Glazing		<b>FLOORING TYPES</b> Material: <input type="text" value="EFC"/> Base: <input type="text" value="FCB"/>		<b>ROOM ACCESSORIES</b> <input type="checkbox"/> Coat Hooks <input type="checkbox"/> Ceiling Lift <input checked="" type="checkbox"/> Magnetic Whiteboard <input type="checkbox"/> Mirror <input type="checkbox"/> Infant Change Table <input type="checkbox"/> Privacy Curtain		
--	--	--	--	--	---	--	--	--	---	--	--

- LEGEND:**
- WALL AND CEILING LEGEND:**
- AC Architectural Ceiling
  - ACT Acoustic Ceiling Tile
  - ACT-C Cleanroom
  - ARGB Abuse-Resistant Gypsum Board
  - GB Gypsum Board
  - IRGB Impact-Resistant Gypsum Board
  - KLCT Kitchen Lay-in Ceiling Tile
  - MMRGB Moisture and Mould-Resistant Gypsum Board
  - SACT Security Acoustic Ceiling Tile
- WALL FINISHES LEGEND:**
- EWC Epoxy Wall Coating
  - HPC High Performance Coating
  - PT Paint
- CEILING FINISHES LEGEND:**
- ECC Epoxy Ceiling Coating
  - HPC High Performance Coating
  - PF Prefinished
  - PT Paint
- WALL PROTECTION LEGEND:**
- ESRP Extruded Semi-Rigid PVCu Panel
  - FRL Fibre Reinforced Laminate
  - FRP Fibreglass Reinforced Plastic
  - PVW Protective Vinyl Wallcovering
  - RHIS Rigid High Impact Sheet
  - WSSP Wetwall Solid Surface Panel
  - WVV Wetroom Vinyl Wallcovering
- FLOOR FINISHES LEGEND:**
- CFS Concrete Floor Sealer
  - EFC Epoxy Floor Coating
  - PFC Polyurethane Floor Coating
  - RAF Rubber Athletic Flooring
  - RSF Rubber Sheet Flooring
  - SCF Seamless Cushioned Flooring
  - SDRF Static-Dissipative Rubber Sheet Flooring
  - SDVF Static-Dissipative Vinyl Sheet Flooring
  - VSF Vinyl Sheet Flooring
  - WSVF Wetroom Safety Vinyl Sheet Flooring
- FLOOR BASE LEGEND:**
- FCB Flash Cove Base
  - RB Rubber Base
  - SCF Seamless Cushioned Flooring

**DOORS**

Types:

Type	Qty	Size (mm)	Material	Finish	Side Lt.	Blinds	Protect.	Privacy Film	Function	Card Reader	Mag Lock	Auto Opener	Hold Open	Hinges	Accessory 1	Accessory 2	Accessory 3	Closer
C2	1	1830 x 2135	Solid Core	FRL	<input type="checkbox"/>	<input type="checkbox"/>	2 High	<input type="checkbox"/>	Storeroom	<input checked="" type="checkbox"/>	<input type="checkbox"/>	<input checked="" type="checkbox"/>	<input type="checkbox"/>	Cont. Swing Clear	Astragal	Flush Bolt	Elec. Strike	Surface

Door Remarks:  Security Grille  Anti-barricade strategy



**MECHANICAL REQUIREMENTS**

<b>PLUMBING</b> (Quantity) Hand Hygiene Sink: <input type="text"/> Lavatory: <input type="text"/> Kitchen Sink: <input type="text"/> Seamless Kitchen Sink: <input type="text"/> Utility / Process Sink: <input type="text"/> Scrub Sink: <input type="text"/> Floor Sink: <input type="text"/>							Other Fixtures: <input type="checkbox"/> Shower <input type="checkbox"/> Eyewash Station <input type="checkbox"/> Tub <input type="checkbox"/> Eyewash/Shower Station <input type="checkbox"/> Ice Maker <input type="checkbox"/> Emergency Shower <input type="checkbox"/> Water Closet <input type="checkbox"/> Flush Rim Sink <input type="checkbox"/> Instantaneous Hot Water <input type="checkbox"/> Floor Drain <input type="checkbox"/> <input type="checkbox"/> Water Bottle Refill Station Other <input type="text"/>				<b>MED / NON-MED GASES</b> (Quantity) Oxygen: <input type="text"/> Medical Air: <input type="text"/> Medical Vacuum: <input type="text"/> Nitrous Oxide: <input type="text"/> CO2: <input type="text"/> AGSS: <input type="text"/> Nitrogen: <input type="text"/> Laboratory Air: <input type="text"/> Laboratory Vacuum: <input type="text"/> Utility Compressed Air: <input type="text"/>					
Plumbing Remarks: <input type="text"/>							Gas Remarks: <input type="text"/>									

**Appendix 1B Minimum Room Requirements**

Room Name:

Program Number(s):

1. W4.07	7.	13.	19.	25.	31.	37.	43.
2.	8.	14.	20.	26.	32.	38.	44.
3.	9.	15.	21.	27.	33.	39.	45.
4.	10.	16.	22.	28.	34.	40.	46.
5.	11.	17.	23.	29.	35.	41.	47.
6.	12.	18.	24.	30.	36.	42.	48.

**ARCHITECTURAL REQUIREMENTS**

<b>WALL AND CEILING</b> Wall Material: <input type="text" value="ARGB 1.2m AFF, GB above"/> Finish: <input type="text" value="PT"/> Ceiling Material: <input type="text" value="ACT"/> Finish: <input type="text" value="PF"/>	<b>WALL PROTECTION</b> Type: <input type="text" value="RHIS"/> <input checked="" type="checkbox"/> Corner Guards <input type="checkbox"/> Hand Rails <input type="checkbox"/> Bed Bumper / Locator Height: <input type="text" value="2185 mm"/> <input checked="" type="checkbox"/> Crash Rails <input type="checkbox"/> Chair Rail	<b>GLAZING</b> <input type="checkbox"/> Interior Glazing	<b>FLOORING TYPES</b> Material: <input type="text" value="RSF"/> Base: <input type="text" value="FCB"/>	<b>ROOM ACCESSORIES</b> <input type="checkbox"/> Coat Hooks <input type="checkbox"/> Ceiling Lift <input checked="" type="checkbox"/> Magnetic Whiteboard <input type="checkbox"/> Mirror <input type="checkbox"/> Infant Change Table <input type="checkbox"/> Privacy Curtain
--	---	---	--	---

- LEGEND:**
- WALL AND CEILING LEGEND:**
- AC Architectural Ceiling
  - ACT Acoustic Ceiling Tile
  - ACT-C Cleanroom
  - ARGB Abuse-Resistant Gypsum Board
  - GB Gypsum Board
  - IRGB Impact-Resistant Gypsum Board
  - KLCT Kitchen Lay-in Ceiling Tile
  - MMRGB Moisture and Mould-Resistant Gypsum Board
  - SACT Security Acoustic Ceiling Tile
- WALL FINISHES LEGEND:**
- EWC Epoxy Wall Coating
  - HPC High Performance Coating
  - PT Paint
- CEILING FINISHES LEGEND:**
- ECC Epoxy Ceiling Coating
  - HPC High Performance Coating
  - PF Prefinished
  - PT Paint
- WALL PROTECTION LEGEND:**
- ESRP Extruded Semi-Rigid PVCu Panel
  - FRL Fibre Reinforced Laminate
  - FRP Fibreglass Reinforced Plastic
  - PVV Protective Vinyl Wallcovering
  - RHIS Rigid High Impact Sheet
  - WSSP Wetwall Solid Surface Panel
  - WVV Wetroom Vinyl Wallcovering
- FLOOR FINISHES LEGEND:**
- CFS Concrete Floor Sealer
  - EFC Epoxy Floor Coating
  - PFC Polyurethane Floor Coating
  - RAF Rubber Athletic Flooring
  - RSF Rubber Sheet Flooring
  - SCF Seamless Cushioned Flooring
  - SDRF Static-Dissipative Rubber Sheet Flooring
  - SDVF Static-Dissipative Vinyl Sheet Flooring
  - VSF Vinyl Sheet Flooring
  - WSVF Wetroom Safety Vinyl Sheet Flooring
- FLOOR BASE LEGEND:**
- FCB Flash Cove Base
  - RB Rubber Base
  - SCF Seamless Cushioned Flooring

**DOORS**

Types:

Type	Qty	Size (mm)	Material	Finish	Side Lt.	Blinds	Protect.	Privacy Film	Function	Card Reader	Mag Lock	Auto Opener	Hold Open	Hinges	Accessory 1	Accessory 2	Accessory 3	Closer
C2	1	1830 x 2135	Solid Core	FRL	<input type="checkbox"/>	<input type="checkbox"/>	2 High	<input type="checkbox"/>	Storeroom	<input checked="" type="checkbox"/>	<input type="checkbox"/>	<input type="checkbox"/>	<input checked="" type="checkbox"/>	Cont. Swing Clear	Astragal	Flush Bolt		Surface

Door Remarks:  Security Grille  Anti-barricade strategy



**MECHANICAL REQUIREMENTS**

<b>PLUMBING</b> (Quantity) Hand Hygiene Sink: <input type="text"/> Lavatory: <input type="text"/> Kitchen Sink: <input type="text"/> Seamless Kitchen Sink: <input type="text"/> Utility / Process Sink: <input type="text"/> Scrub Sink: <input type="text"/> Floor Sink: <input type="text"/> Plumbing Remarks: <input type="text"/>	Other Fixtures: <input type="checkbox"/> Shower <input type="checkbox"/> Eyewash Station <input type="checkbox"/> Tub <input type="checkbox"/> Eyewash/Shower Station <input type="checkbox"/> Ice Maker <input type="checkbox"/> Emergency Shower <input type="checkbox"/> Water Closet <input type="checkbox"/> Flush Rim Sink <input type="checkbox"/> Instantaneous Hot Water <input type="checkbox"/> Floor Drain <input type="checkbox"/> <input type="checkbox"/> Water Bottle Refill Station Other <input type="text"/>	<b>MED / NON-MED GASES</b> (Quantity) Oxygen: <input type="text"/> Medical Air: <input type="text"/> Medical Vacuum: <input type="text"/> Nitrous Oxide: <input type="text"/> CO2: <input type="text"/> AGSS: <input type="text"/> Nitrogen: <input type="text"/> Laboratory Air: <input type="text"/> Laboratory Vacuum: <input type="text"/> Utility Compressed Air: <input type="text"/> Gas Remarks: <input type="text"/>
---	--	---

**Appendix 1B Minimum Room Requirements**

Room Name:

Program Number(s):

1. W1.06	7.	13.	19.	25.	31.	37.	43.
2.	8.	14.	20.	26.	32.	38.	44.
3.	9.	15.	21.	27.	33.	39.	45.
4.	10.	16.	22.	28.	34.	40.	46.
5.	11.	17.	23.	29.	35.	41.	47.
6.	12.	18.	24.	30.	36.	42.	48.

**ARCHITECTURAL REQUIREMENTS**

<b>WALL AND CEILING</b> Wall Material: <input type="text" value="ARGB 1.2m AFF, GB above"/> Finish: <input type="text" value="PT"/> Ceiling Material: <input type="text" value="ACT"/> Finish: <input type="text" value="PF"/>	<b>WALL PROTECTION</b> Type: <input type="text" value="ESRP"/> <input checked="" type="checkbox"/> Corner Guards <input type="checkbox"/> Hand Rails <input type="checkbox"/> Bed Bumper / Locator Height: <input type="text" value="2185 mm"/> <input checked="" type="checkbox"/> Crash Rails <input type="checkbox"/> Chair Rail	<b>GLAZING</b> <input type="checkbox"/> Interior Glazing	<b>FLOORING TYPES</b> Material: <input type="text" value="EFC"/> Base: <input type="text" value="FCB"/>	<b>ROOM ACCESSORIES</b> <input type="checkbox"/> Coat Hooks <input type="checkbox"/> Ceiling Lift <input type="checkbox"/> Magnetic Whiteboard <input type="checkbox"/> Mirror <input type="checkbox"/> Infant Change Table <input type="checkbox"/> Privacy Curtain
--	---	---	--	--

- LEGEND:**
- WALL AND CEILING LEGEND:**
- AC Architectural Ceiling
  - ACT Acoustic Ceiling Tile
  - ACT-C Cleanroom
  - ARGB Abuse-Resistant Gypsum Board
  - GB Gypsum Board
  - IRGB Impact-Resistant Gypsum Board
  - KLCT Kitchen Lay-in Ceiling Tile
  - MMRGB Moisture and Mould-Resistant Gypsum Board
  - SACT Security Acoustic Ceiling Tile
- WALL FINISHES LEGEND:**
- EWC Epoxy Wall Coating
  - HPC High Performance Coating
  - PT Paint
- CEILING FINISHES LEGEND:**
- ECC Epoxy Ceiling Coating
  - HPC High Performance Coating
  - PF Prefinished
  - PT Paint
- WALL PROTECTION LEGEND:**
- ESRP Extruded Semi-Rigid PVCu Panel
  - FRL Fibre Reinforced Laminated
  - FRP Fibreglass Reinforced Plastic
  - PVV Protective Vinyl Wallcovering
  - RHIS Rigid High Impact Sheet
  - WSSP Wetwall Solid Surface Panel
  - WVV Wetroom Vinyl Wallcovering
- FLOOR FINISHES LEGEND:**
- CFS Concrete Floor Sealer
  - EFC Epoxy Floor Coating
  - PFC Polyurethane Floor Coating
  - RAF Rubber Athletic Flooring
  - RSF Rubber Sheet Flooring
  - SCF Seamless Cushioned Flooring
  - SDRF Static-Dissipative Rubber Sheet Flooring
  - SDVF Static-Dissipative Vinyl Sheet Flooring
  - VSF Vinyl Sheet Flooring
  - WSVF Wetroom Safety Vinyl Sheet Flooring
- FLOOR BASE LEGEND:**
- FCB Flash Cove Base
  - RB Rubber Base
  - SCF Seamless Cushioned Flooring

**DOORS**

Types:

Type	Qty	Size (mm)	Material	Finish	Side Lt.	Blinds	Protect.	Privacy Film	Function	Card Reader	Mag Lock	Auto Opener	Hold Open	Hinges	Accessory 1	Accessory 2	Accessory 3	Closer
A2	1	1830 x 2135	Hollow Metal	Paint	<input type="checkbox"/>	<input type="checkbox"/>		<input type="checkbox"/>	Storeroom	<input checked="" type="checkbox"/>	<input type="checkbox"/>	<input type="checkbox"/>	<input type="checkbox"/>	Cont. Swing Clear	Astragal	Flush Bolt		Surface
A	2	1065 x 2135	Solid Core	FRL	<input type="checkbox"/>	<input type="checkbox"/>	2 High	<input type="checkbox"/>	Storeroom	<input checked="" type="checkbox"/>	<input type="checkbox"/>	<input type="checkbox"/>	<input checked="" type="checkbox"/>	Butt Hinge				Surface

Door Remarks:  Security Grille  Anti-barricade strategy

**MILLWORK AND SPECIALTY CASEWORK**

Storage Requirements:

**FINISHES**

Full-height Cabinet:

Upper Millwork:

Countertop:

Lower Millwork:

Shelf:

Remarks: Refer to Schedule 1, Section 6.11 (Division 11) for Medical Gas Racks.

**MECHANICAL REQUIREMENTS**

<b>PLUMBING</b> (Quantity) Hand Hygiene Sink: <input type="text"/> Lavatory: <input type="text"/> Kitchen Sink: <input type="text"/> Seamless Kitchen Sink: <input type="text"/> Utility / Process Sink: <input type="text"/> Scrub Sink: <input type="text"/> Floor Sink: <input type="text"/> Plumbing Remarks: <input type="text"/>	Other Fixtures: <input type="checkbox"/> Shower <input type="checkbox"/> Eyewash Station <input type="checkbox"/> Tub <input type="checkbox"/> Eyewash/Shower Station <input type="checkbox"/> Ice Maker <input type="checkbox"/> Emergency Shower <input type="checkbox"/> Water Closet <input type="checkbox"/> Flush Rim Sink <input type="checkbox"/> Instantaneous Hot Water <input type="checkbox"/> Floor Drain <input type="checkbox"/> <input type="checkbox"/> Water Bottle Refill Station Other: <input type="text"/>	<b>MED / NON-MED GASES</b> (Quantity) Oxygen: <input type="text"/> Medical Air: <input type="text"/> Medical Vacuum: <input type="text"/> Nitrous Oxide: <input type="text"/> CO2: <input type="text"/> AGSS: <input type="text"/> Nitrogen: <input type="text"/> Laboratory Air: <input type="text"/> Laboratory Vacuum: <input type="text"/> Utility Compressed Air: <input type="text"/> Gas Remarks: <input type="text"/>
---	---	---



**Appendix 1B Minimum Room Requirements**

Room Name:

Program Number(s):

1. W1.04	7.	13.	19.	25.	31.	37.	43.
2.	8.	14.	20.	26.	32.	38.	44.
3.	9.	15.	21.	27.	33.	39.	45.
4.	10.	16.	22.	28.	34.	40.	46.
5.	11.	17.	23.	29.	35.	41.	47.
6.	12.	18.	24.	30.	36.	42.	48.

**ARCHITECTURAL REQUIREMENTS**

<b>WALL AND CEILING</b> Wall Material: <input type="text" value="ARGB 1.2m AFF, GB above"/> Finish: <input type="text" value="PT"/> Ceiling Material: <input type="text" value="ACT"/> Finish: <input type="text" value="PF"/>	<b>WALL PROTECTION</b> Type: <input type="text" value="RHIS"/> <input checked="" type="checkbox"/> Corner Guards <input type="checkbox"/> Hand Rails <input type="checkbox"/> Bed Bumper / Locator Height: <input type="text" value="2185 mm"/> <input type="checkbox"/> Crash Rails <input type="checkbox"/> Chair Rail	<b>GLAZING</b> <input type="checkbox"/> Interior Glazing	<b>FLOORING TYPES</b> Material: <input type="text" value="EFC"/> Base: <input type="text" value="FCB"/>	<b>ROOM ACCESSORIES</b> <input type="checkbox"/> Coat Hooks <input type="checkbox"/> Ceiling Lift <input type="checkbox"/> Magnetic Whiteboard <input type="checkbox"/> Mirror <input type="checkbox"/> Infant Change Table <input type="checkbox"/> Privacy Curtain
--	--	---	--	--

- LEGEND:**
- WALL AND CEILING LEGEND:**
- AC Architectural Ceiling
  - ACT Acoustic Ceiling Tile
  - ACT-C Cleanroom
  - ARGB Abuse-Resistant Gypsum Board
  - GB Gypsum Board
  - IRGB Impact-Resistant Gypsum Board
  - KLCT Kitchen Lay-in Ceiling Tile
  - MMRGB Moisture and Mould-Resistant Gypsum Board
  - SACT Security Acoustic Ceiling Tile
- WALL FINISHES LEGEND:**
- EWC Epoxy Wall Coating
  - HPC High Performance Coating
  - PT Paint
- CEILING FINISHES LEGEND:**
- ECC Epoxy Ceiling Coating
  - HPC High Performance Coating
  - PF Prefinished
  - PT Paint
- WALL PROTECTION LEGEND:**
- ESRP Extruded Semi-Rigid PVCu Panel
  - FRL Fibre Reinforced Laminate
  - FRP Fibreglass Reinforced Plastic
  - PVV Protective Vinyl Wallcovering
  - RHIS Rigid High Impact Sheet
  - WSSP Wetwall Solid Surface Panel
  - WVV Wetroom Vinyl Wallcovering
- FLOOR FINISHES LEGEND:**
- CFS Concrete Floor Sealer
  - EFC Epoxy Floor Coating
  - PFC Polyurethane Floor Coating
  - RAF Rubber Athletic Flooring
  - RSF Rubber Sheet Flooring
  - SCF Seamless Cushioned Flooring
  - SDRF Static-Dissipative Rubber Sheet Flooring
  - SDVF Static-Dissipative Vinyl Sheet Flooring
  - VSF Vinyl Sheet Flooring
  - WSVF Wetroom Safety Vinyl Sheet Flooring
- FLOOR BASE LEGEND:**
- FCB Flash Cove Base
  - RB Rubber Base
  - SCF Seamless Cushioned Flooring

**DOORS**

Types:

Type	Qty	Size (mm)	Material	Finish	Side Lt.	Blinds	Protect.	Privacy Film	Function	Card Reader	Mag Lock	Auto Opener	Hold Open	Hinges	Accessory 1	Accessory 2	Accessory 3	Closer
A	1	1065 x 2135	Hollow Metal	Paint	<input type="checkbox"/>	<input type="checkbox"/>		<input type="checkbox"/>	Storeroom	<input checked="" type="checkbox"/>	<input type="checkbox"/>	<input type="checkbox"/>	<input checked="" type="checkbox"/>	Cont. Swing Clear				Surface

Door Remarks:  Security Grille  Anti-barricade strategy



**MECHANICAL REQUIREMENTS**

<b>PLUMBING</b> (Quantity) Hand Hygiene Sink: <input type="text" value="1"/> Lavatory: <input type="text"/> Kitchen Sink: <input type="text"/> Seamless Kitchen Sink: <input type="text"/> Utility / Process Sink: <input type="text"/> Scrub Sink: <input type="text"/> Floor Sink: <input type="text"/> Plumbing Remarks: <input type="text"/>	Other Fixtures: <input type="checkbox"/> Shower <input type="checkbox"/> Tub <input type="checkbox"/> Ice Maker <input type="checkbox"/> Water Closet <input type="checkbox"/> Instantaneous Hot Water <input type="checkbox"/> Eyewash Station <input type="checkbox"/> Eyewash/Shower Station <input type="checkbox"/> Emergency Shower <input type="checkbox"/> Flush Rim Sink <input type="checkbox"/> Floor Drain <input type="checkbox"/> Water Bottle Refill Station Other: <input type="text"/>	<b>MED / NON-MED GASES</b> (Quantity) Oxygen: <input type="text"/> Medical Air: <input type="text"/> Medical Vacuum: <input type="text"/> Nitrous Oxide: <input type="text"/> CO2: <input type="text"/> AGSS: <input type="text"/> Nitrogen: <input type="text"/> Laboratory Air: <input type="text"/> Laboratory Vacuum: <input type="text"/> Utility Compressed Air: <input type="text"/> Gas Remarks: <input type="text"/>
--	--	---

**Appendix 1B Minimum Room Requirements**

Room Name:

Program Number(s):

1. W5.04	7.	13.	19.	25.	31.	37.	43.
2.	8.	14.	20.	26.	32.	38.	44.
3.	9.	15.	21.	27.	33.	39.	45.
4.	10.	16.	22.	28.	34.	40.	46.
5.	11.	17.	23.	29.	35.	41.	47.
6.	12.	18.	24.	30.	36.	42.	48.

**ARCHITECTURAL REQUIREMENTS**

<b>WALL AND CEILING</b> Wall Material: <input type="text" value="ARGB 1.2m AFF, GB above"/> Finish: <input type="text" value="PT"/> Ceiling Material: <input type="text" value="ACT"/> Finish: <input type="text" value="PF"/>	<b>WALL PROTECTION</b> Type: <input type="text" value="RHIS"/> <input checked="" type="checkbox"/> Corner Guards <input type="checkbox"/> Hand Rails <input type="checkbox"/> Bed Bumper / Locator Height: <input type="text" value="2185 mm"/> <input type="checkbox"/> Crash Rails <input type="checkbox"/> Chair Rail	<b>GLAZING</b> <input type="checkbox"/> Interior Glazing	<b>FLOORING TYPES</b> Material: <input type="text" value="VSF"/> Base: <input type="text" value="FCB"/>	<b>ROOM ACCESSORIES</b> <input type="checkbox"/> Coat Hooks <input type="checkbox"/> Ceiling Lift <input type="checkbox"/> Magnetic Whiteboard <input type="checkbox"/> Mirror <input type="checkbox"/> Infant Change Table <input type="checkbox"/> Privacy Curtain
--	--	---	--	--

- LEGEND:**
- WALL AND CEILING LEGEND:**
- AC Architectural Ceiling
  - ACT Acoustic Ceiling Tile
  - ACT-C Cleanroom
  - ARGB Abuse-Resistant Gypsum Board
  - GB Gypsum Board
  - IRGB Impact-Resistant Gypsum Board
  - KLCT Kitchen Lay-in Ceiling Tile
  - MMRGB Moisture and Mould-Resistant Gypsum Board
  - SACT Security Acoustic Ceiling Tile
- WALL FINISHES LEGEND:**
- EWC Epoxy Wall Coating
  - HPC High Performance Coating
  - PT Paint
- CEILING FINISHES LEGEND:**
- ECC Epoxy Ceiling Coating
  - HPC High Performance Coating
  - PF Prefinished
  - PT Paint
- WALL PROTECTION LEGEND:**
- ESRP Extruded Semi-Rigid PVCu Panel
  - FRL Fibre Reinforced Laminate
  - FRP Fibreglass Reinforced Plastic
  - PVV Protective Vinyl Wallcovering
  - RHIS Rigid High Impact Sheet
  - WSSP Wetwall Solid Surface Panel
  - WVV Wetroom Vinyl Wallcovering
- FLOOR FINISHES LEGEND:**
- CFS Concrete Floor Sealer
  - EFC Epoxy Floor Coating
  - PFC Polyurethane Floor Coating
  - RAF Rubber Athletic Flooring
  - RSF Rubber Sheet Flooring
  - SCF Seamless Cushioned Flooring
  - SDRF Static-Dissipative Rubber Sheet Flooring
  - SDVF Static-Dissipative Vinyl Sheet Flooring
  - VSF Vinyl Sheet Flooring
  - WSVF Wetroom Safety Vinyl Sheet Flooring
- FLOOR BASE LEGEND:**
- FCB Flash Cove Base
  - RB Rubber Base
  - SCF Seamless Cushioned Flooring

**DOORS**

Types:

Type	Qty	Size (mm)	Material	Finish	Side Lt.	Blinds	Protect.	Privacy Film	Function	Card Reader	Mag Lock	Auto Opener	Hold Open	Hinges	Accessory 1	Accessory 2	Accessory 3	Closer
C2	1	1830 x 2135	Solid Core	FRL	<input type="checkbox"/>	<input type="checkbox"/>	2 High	<input type="checkbox"/>	Storeroom	<input checked="" type="checkbox"/>	<input type="checkbox"/>	<input type="checkbox"/>	<input type="checkbox"/>	Cont. Swing Clear	Astragal	Flush Bolt		Surface

Door Remarks:  Security Grille  Anti-barricade strategy

**MILLWORK AND SPECIALTY CASEWORK**

Storage Requirements:

**UPPER UNITS** (U1-U8)

**LOWER UNITS** (L1-L12)

**RECEPTION/TRANSACTION COUNTER / CARE TEAM STATION DESK** (TC1, TC2)

**UTILITY SINK AND COUNTER UNIT** (UC1)

**FINISHES**

- Full-height Cabinet:
- Upper Millwork:
- Countertop:
- Lower Millwork:
- Shelf:

Remarks:

**Legend:**

Category	Min. Length (mm)	Motorized Adjustable Height	Standing Height	Specialty Casework
3	3000	<input type="checkbox"/>	<input type="checkbox"/>	<input type="checkbox"/>

**MECHANICAL REQUIREMENTS**

<b>PLUMBING</b> (Quantity) Hand Hygiene Sink: <input type="text"/> Lavatory: <input type="text"/> Kitchen Sink: <input type="text"/> Seamless Kitchen Sink: <input type="text"/> Utility / Process Sink: <input type="text"/> Scrub Sink: <input type="text"/> Floor Sink: <input type="text"/> Plumbing Remarks: <input type="text"/>	Other Fixtures: <input type="checkbox"/> Shower <input type="checkbox"/> Eyewash Station <input type="checkbox"/> Tub <input type="checkbox"/> Eyewash/Shower Station <input type="checkbox"/> Ice Maker <input type="checkbox"/> Emergency Shower <input type="checkbox"/> Water Closet <input type="checkbox"/> Flush Rim Sink <input type="checkbox"/> Instantaneous Hot Water <input type="checkbox"/> Floor Drain <input type="checkbox"/> <input type="checkbox"/> Water Bottle Refill Station Other: <input type="text"/>	<b>MED / NON-MED GASES</b> (Quantity) Oxygen: <input type="text"/> Medical Air: <input type="text"/> Medical Vacuum: <input type="text"/> Nitrous Oxide: <input type="text"/> CO2: <input type="text"/> AGSS: <input type="text"/> Nitrogen: <input type="text"/> Laboratory Air: <input type="text"/> Laboratory Vacuum: <input type="text"/> Utility Compressed Air: <input type="text"/> Gas Remarks: <input type="text"/>
---	---	--

**Appendix 1B Minimum Room Requirements**

Room Name:

Program Number(s):

1. W2.02	7.	13.	19.	25.	31.	37.	43.
2.	8.	14.	20.	26.	32.	38.	44.
3.	9.	15.	21.	27.	33.	39.	45.
4.	10.	16.	22.	28.	34.	40.	46.
5.	11.	17.	23.	29.	35.	41.	47.
6.	12.	18.	24.	30.	36.	42.	48.

**ARCHITECTURAL REQUIREMENTS**

<b>WALL AND CEILING</b> Wall Material: <input type="text" value="ARGB 1.2m AFF, GB above"/> Finish: <input type="text" value="PT"/> Ceiling Material: <input type="text" value="ACT"/> Finish: <input type="text" value="PF"/>	<b>WALL PROTECTION</b> Type: <input type="text" value="RHIS"/> <input checked="" type="checkbox"/> Corner Guards <input type="checkbox"/> Hand Rails <input type="checkbox"/> Bed Bumper / Locator Height: <input type="text" value="2185 mm"/> <input type="checkbox"/> Crash Rails <input type="checkbox"/> Chair Rail	<b>GLAZING</b> <input type="checkbox"/> Interior Glazing	<b>FLOORING TYPES</b> Material: <input type="text" value="VSF"/> Base: <input type="text" value="FCB"/>	<b>ROOM ACCESSORIES</b> <input type="checkbox"/> Coat Hooks <input type="checkbox"/> Ceiling Lift <input type="checkbox"/> Magnetic Whiteboard <input type="checkbox"/> Mirror <input type="checkbox"/> Infant Change Table <input type="checkbox"/> Privacy Curtain
--	--	---	--	--

- LEGEND:**
- WALL AND CEILING LEGEND:**
- AC Architectural Ceiling
  - ACT Acoustic Ceiling Tile
  - ACT-C Cleanroom
  - ARGB Abuse-Resistant Gypsum Board
  - GB Gypsum Board
  - IRGB Impact-Resistant Gypsum Board
  - KLCT Kitchen Lay-in Ceiling Tile
  - MMRGB Moisture and Mould-Resistant Gypsum Board
  - SACT Security Acoustic Ceiling Tile
- WALL FINISHES LEGEND:**
- EWC Epoxy Wall Coating
  - HPC High Performance Coating
  - PT Paint
- CEILING FINISHES LEGEND:**
- ECC Epoxy Ceiling Coating
  - HPC High Performance Coating
  - PF Prefinished
  - PT Paint
- WALL PROTECTION LEGEND:**
- ESRP Extruded Semi-Rigid PVCu Panel
  - FRL Fibre Reinforced Laminate
  - FRP Fibreglass Reinforced Plastic
  - PVV Protective Vinyl Wallcovering
  - RHIS Rigid High Impact Sheet
  - WSSP Wetwall Solid Surface Panel
  - WVV Wetroom Vinyl Wallcovering
- FLOOR FINISHES LEGEND:**
- CFS Concrete Floor Sealer
  - EFC Epoxy Floor Coating
  - PFC Polyurethane Floor Coating
  - RAF Rubber Athletic Flooring
  - RSF Rubber Sheet Flooring
  - SCF Seamless Cushioned Flooring
  - SDRF Static-Dissipative Rubber Sheet Flooring
  - SDVF Static-Dissipative Vinyl Sheet Flooring
  - VSF Vinyl Sheet Flooring
  - WSVF Wetroom Safety Vinyl Sheet Flooring
- FLOOR BASE LEGEND:**
- FCB Flash Cove Base
  - RB Rubber Base
  - SCF Seamless Cushioned Flooring

**DOORS**

Types:

Type	Qty	Size (mm)	Material	Finish	Side Lt.	Blinds	Protect.	Privacy Film	Function	Card Reader	Mag Lock	Auto Opener	Hold Open	Hinges	Accessory 1	Accessory 2	Accessory 3	Closer
A	1	915 x 2135	Solid Core	FRL	<input type="checkbox"/>	<input type="checkbox"/>	2 High	<input type="checkbox"/>	Storeroom	<input checked="" type="checkbox"/>	<input type="checkbox"/>	<input type="checkbox"/>	<input type="checkbox"/>	Cont. Swing Clear				Surface

**DOOR REMARKS:**

Security Grille  
 Anti-barricade strategy

**MILLWORK AND SPECIALTY CASEWORK**

Storage Requirements:

**UPPER UNITS:** U1, U2, U3, U4, U5, U6, U7, U8

**LOWER UNITS:** L1, L2, L3, L4, L5, L6, L7, L8, L9, L10, L11, L12

**RECEPTION/TRANSACTION COUNTER / CARE TEAM STATION DESK:** TC1, TC2

**UTILITY SINK AND COUNTER UNIT:** UC1

**SHELF:** S1

**FULL-HEIGHT CABINETS:** C1, C2, C3, C4, C5

**Legend:**

Category	Min. Length (mm)	Motorized Adjustable Height	Standing Height	Specialty Casework
Category 0 - None		<input type="checkbox"/>	<input type="checkbox"/>	<input type="checkbox"/>
Category 1 - Low (1% - 4%)		<input type="checkbox"/>	<input type="checkbox"/>	<input type="checkbox"/>
Category 2 - Med (5% - 9%)		<input type="checkbox"/>	<input type="checkbox"/>	<input type="checkbox"/>
Category 3 - High (10% or Greater)		<input type="checkbox"/>	<input type="checkbox"/>	<input type="checkbox"/>

**FINISHES**

Full-height Cabinet:   
 Upper Millwork:   
 Countertop:   
 Lower Millwork:   
 Shelf:

**REMARKS:**

**MECHANICAL REQUIREMENTS**

<b>PLUMBING</b> (Quantity) Hand Hygiene Sink: <input type="text"/> Lavatory: <input type="text"/> Kitchen Sink: <input type="text"/> Kitchen Sink: <input type="text"/> Utility / Process Sink: <input type="text"/> Scrub Sink: <input type="text"/> Floor Sink: <input type="text"/> Plumbing Remarks: <input type="text"/>	Other Fixtures: <input type="checkbox"/> Shower <input type="checkbox"/> Tub <input type="checkbox"/> Ice Maker <input type="checkbox"/> Water Closet <input type="checkbox"/> Instantaneous Hot Water <input type="checkbox"/> Eyewash Station <input type="checkbox"/> Eyewash/Shower Station <input type="checkbox"/> Emergency Shower <input type="checkbox"/> Flush Rim Sink <input type="checkbox"/> Floor Drain <input type="checkbox"/> Water Bottle Refill Station Other: <input type="text"/>	<b>MED / NON-MED GASES</b> (Quantity) Oxygen: <input type="text"/> Medical Air: <input type="text"/> Medical Vacuum: <input type="text"/> Nitrous Oxide: <input type="text"/> CO2: <input type="text"/> AGSS: <input type="text"/> Nitrogen: <input type="text"/> Laboratory Air: <input type="text"/> Laboratory Vacuum: <input type="text"/> Utility Compressed Air: <input type="text"/> Gas Remarks: <input type="text"/>
--	---	---



**Appendix 1B Minimum Room Requirements**

Room Name:

Program Number(s):

1.	W1.01	7.	13.	19.	25.	31.	37.	43.
2.		8.	14.	20.	26.	32.	38.	44.
3.		9.	15.	21.	27.	33.	39.	45.
4.		10.	16.	22.	28.	34.	40.	46.
5.		11.	17.	23.	29.	35.	41.	47.
6.		12.	18.	24.	30.	36.	42.	48.

**ARCHITECTURAL REQUIREMENTS**

<b>WALL AND CEILING</b> Wall Material: <input type="text" value="MMRGB"/> Finish: <input type="text" value="PT"/> Ceiling Material: <input type="text" value="ACT"/> Finish: <input type="text" value="PF"/>		<b>WALL PROTECTION</b> Type: <input type="text" value="RHIS"/> <input checked="" type="checkbox"/> Corner Guards <input type="checkbox"/> Hand Rails <input type="checkbox"/> Bed Bumper / Locator Height: <input type="text" value="2185 mm"/> <input type="checkbox"/> Crash Rails <input type="checkbox"/> Chair Rail		<b>GLAZING</b> <input type="checkbox"/> Interior Glazing		<b>FLOORING TYPES</b> Material: <input type="text" value="EFC"/> Base: <input type="text" value="FCB"/>		<b>ROOM ACCESSORIES</b> <input type="checkbox"/> Coat Hooks <input type="checkbox"/> Ceiling Lift <input type="checkbox"/> Magnetic Whiteboard <input type="checkbox"/> Mirror <input type="checkbox"/> Infant Change Table <input type="checkbox"/> Privacy Curtain	
--	--	--	--	---	--	--	--	--	--

- LEGEND:**
- WALL AND CEILING LEGEND:**
- AC Architectural Ceiling
  - ACT Acoustic Ceiling Tile
  - ACT-C Cleanroom
  - ARGB Abuse-Resistant Gypsum Board
  - GB Gypsum Board
  - IRGB Impact-Resistant Gypsum Board
  - KLCT Kitchen Lay-in Ceiling Tile
  - MMRGB Moisture and Mould-Resistant Gypsum Board
  - SACT Security Acoustic Ceiling Tile
- WALL FINISHES LEGEND:**
- EWC Epoxy Wall Coating
  - HPC High Performance Coating
  - PT Paint
- CEILING FINISHES LEGEND:**
- ECC Epoxy Ceiling Coating
  - HPC High Performance Coating
  - PF Prefinished
  - PT Paint
- WALL PROTECTION LEGEND:**
- ESRP Extruded Semi-Rigid PVCu Panel
  - FRL Fibre Reinforced Laminate
  - FRP Fibreglass Reinforced Plastic
  - PVV Protective Vinyl Wallcovering
  - RHIS Rigid High Impact Sheet
  - WSSP Wetwall Solid Surface Panel
  - WVV Wetroom Vinyl Wallcovering
- FLOOR FINISHES LEGEND:**
- CFS Concrete Floor Sealer
  - EFC Epoxy Floor Coating
  - PFC Polyurethane Floor Coating
  - RAF Rubber Athletic Flooring
  - RSF Rubber Sheet Flooring
  - SCF Seamless Cushioned Flooring
  - SDRF Static-Dissipative Rubber Sheet Flooring
  - SDVF Static-Dissipative Vinyl Sheet Flooring
  - VSF Vinyl Sheet Flooring
  - WSVF Wetroom Safety Vinyl Sheet Flooring
- FLOOR BASE LEGEND:**
- FCB Flash Cove Base
  - RB Rubber Base
  - SCF Seamless Cushioned Flooring

**DOORS**

Types:

Type	Qty	Size (mm)	Material	Finish	Side Lt.	Blinds	Protect.	Privacy Film	Function	Card Reader	Mag Lock	Auto Opener	Hold Open	Hinges	Accessory 1	Accessory 2	Accessory 3	Closer
C2	1	1830 x 2135	Hollow Metal	Paint	<input type="checkbox"/>	<input type="checkbox"/>		<input type="checkbox"/>	Storeroom	<input checked="" type="checkbox"/>	<input type="checkbox"/>	<input checked="" type="checkbox"/>	<input checked="" type="checkbox"/>	Cont. Swing Clear	Astragal	Flush Bolt		Surface

Door Remarks: Provide interior high-speed service doors; refer to Schedule 1.

Security Grille  
 Anti-barricade strategy



**MECHANICAL REQUIREMENTS**

<b>PLUMBING</b> (Quantity) Hand Hygiene Sink: <input type="text" value="1"/> Lavatory: <input type="text"/> Kitchen Sink: <input type="text" value="1"/> Seamless Kitchen Sink: <input type="text"/> Utility / Process Sink: <input type="text"/> Scrub Sink: <input type="text"/> Floor Sink: <input type="text"/> Plumbing Remarks: <input type="text"/>		Other Fixtures: <input type="checkbox"/> Shower <input type="checkbox"/> Tub <input checked="" type="checkbox"/> Ice Maker <input type="checkbox"/> Water Closet <input checked="" type="checkbox"/> Instantaneous Hot Water <input type="checkbox"/> Eyewash Station <input type="checkbox"/> Eyewash/Shower Station <input type="checkbox"/> Emergency Shower <input type="checkbox"/> Flush Rim Sink <input type="checkbox"/> Floor Drain <input type="checkbox"/> Water Bottle Refill Station Other: <input type="text"/>		<b>MED / NON-MED GASES</b> (Quantity) Oxygen: <input type="text"/> Medical Air: <input type="text"/> Medical Vacuum: <input type="text"/> Nitrous Oxide: <input type="text"/> CO2: <input type="text"/> AGSS: <input type="text"/> Nitrogen: <input type="text"/> Laboratory Air: <input type="text"/> Laboratory Vacuum: <input type="text"/> Utility Compressed Air: <input type="text"/> Gas Remarks: <input type="text"/>	
---	--	--	--	---	--

**Appendix 1B Minimum Room Requirements**

Room Name:

Program Number(s):

1. W5.01	7.	13.	19.	25.	31.	37.	43.
2.	8.	14.	20.	26.	32.	38.	44.
3.	9.	15.	21.	27.	33.	39.	45.
4.	10.	16.	22.	28.	34.	40.	46.
5.	11.	17.	23.	29.	35.	41.	47.
6.	12.	18.	24.	30.	36.	42.	48.

**ARCHITECTURAL REQUIREMENTS**

<b>WALL AND CEILING</b> Wall Material: <input type="text" value="ARGB 1.2m AFF, GB above"/> Finish: <input type="text" value="PT"/> Ceiling Material: <input type="text" value="ACT"/> Finish: <input type="text" value="PF"/>	<b>WALL PROTECTION</b> Type: <input type="text" value="FRP"/> <input checked="" type="checkbox"/> Corner Guards <input type="checkbox"/> Hand Rails <input type="checkbox"/> Bed Bumper / Locator Height: <input type="text" value="2185 mm"/> <input type="checkbox"/> Crash Rails <input checked="" type="checkbox"/> Chair Rail	<b>GLAZING</b> <input type="checkbox"/> Interior Glazing	<b>FLOORING TYPES</b> Material: <input type="text" value="EFC"/> Base: <input type="text" value="RB"/>	<b>ROOM ACCESSORIES</b> <input checked="" type="checkbox"/> Coat Hooks <input type="checkbox"/> Ceiling Lift <input checked="" type="checkbox"/> Magnetic Whiteboard <input type="checkbox"/> Mirror <input type="checkbox"/> Infant Change Table <input type="checkbox"/> Privacy Curtain
--	--	---	---	--

- LEGEND:**
- WALL AND CEILING LEGEND:**
- AC Architectural Ceiling
  - ACT Acoustic Ceiling Tile
  - ACT-C Cleanroom
  - ARGB Abuse-Resistant Gypsum Board
  - GB Gypsum Board
  - IRGB Impact-Resistant Gypsum Board
  - KLCT Kitchen Lay-in Ceiling Tile
  - MMRGB Moisture and Mould-Resistant Gypsum Board
  - SACT Security Acoustic Ceiling Tile
- WALL FINISHES LEGEND:**
- EWC Epoxy Wall Coating
  - HPC High Performance Coating
  - PT Paint
- CEILING FINISHES LEGEND:**
- ECC Epoxy Ceiling Coating
  - HPC High Performance Coating
  - PF Prefinished
  - PT Paint
- WALL PROTECTION LEGEND:**
- ESRP Extruded Semi-Rigid PVCu Panel
  - FRL Fibre Reinforced Laminate
  - FRP Fibreglass Reinforced Plastic
  - PVV Protective Vinyl Wallcovering
  - RHIS Rigid High Impact Sheet
  - WSSP Wetwall Solid Surface Panel
  - WVV Wetroom Vinyl Wallcovering
- FLOOR FINISHES LEGEND:**
- CFS Concrete Floor Sealer
  - EFC Epoxy Floor Coating
  - PFC Polyurethane Floor Coating
  - RAF Rubber Athletic Flooring
  - RSF Rubber Sheet Flooring
  - SCF Seamless Cushioned Flooring
  - SDRF Static-Dissipative Rubber Sheet Flooring
  - SDVF Static-Dissipative Vinyl Sheet Flooring
  - VSF Vinyl Sheet Flooring
  - WSVF Wetroom Safety Vinyl Sheet Flooring
- FLOOR BASE LEGEND:**
- FCB Flash Cove Base
  - RB Rubber Base
  - SCF Seamless Cushioned Flooring

**DOORS**

Types:

Type	Qty	Size (mm)	Material	Finish	Side Lt.	Blinds	Protect.	Privacy Film	Function	Card Reader	Mag Lock	Auto Opener	Hold Open	Hinges	Accessory 1	Accessory 2	Accessory 3	Closer
C2	1	2440 x 2135	Solid Core	FRL	<input type="checkbox"/>	<input type="checkbox"/>	2 High	<input type="checkbox"/>	Storeroom	<input checked="" type="checkbox"/>	<input type="checkbox"/>	<input type="checkbox"/>	<input checked="" type="checkbox"/>	Butt Hinge	Astragal	Flush Bolt		Surface

Door Remarks:  Security Grille  Anti-barricade strategy



**MECHANICAL REQUIREMENTS**

<b>PLUMBING</b> (Quantity) Hand Hygiene Sink: <input type="text"/> Lavatory: <input type="text"/> Kitchen Sink: <input type="text"/> Seamless Kitchen Sink: <input type="text"/> Utility / Process Sink: <input type="text"/> Scrub Sink: <input type="text"/> Floor Sink: <input type="text"/> Plumbing Remarks: <input type="text"/>	Other Fixtures: <input type="checkbox"/> Shower <input type="checkbox"/> Eyewash Station <input type="checkbox"/> Tub <input type="checkbox"/> Eyewash/Shower Station <input type="checkbox"/> Ice Maker <input type="checkbox"/> Emergency Shower <input type="checkbox"/> Water Closet <input type="checkbox"/> Flush Rim Sink <input type="checkbox"/> Instantaneous Hot Water <input type="checkbox"/> Floor Drain <input type="checkbox"/> Water Bottle Refill Station Other: <input type="text"/>	<b>MED / NON-MED GASES</b> (Quantity) Oxygen: <input type="text"/> Medical Air: <input type="text"/> Medical Vacuum: <input type="text"/> Nitrous Oxide: <input type="text"/> CO2: <input type="text"/> AGSS: <input type="text"/> Nitrogen: <input type="text"/> Laboratory Air: <input type="text"/> Laboratory Vacuum: <input type="text"/> Utility Compressed Air: <input type="text"/> Gas Remarks: <input type="text"/>
---	--	---

**Appendix 1B Minimum Room Requirements**

Room Name:

Program Number(s):

1. W4.09	7.	13.	19.	25.	31.	37.	43.
2.	8.	14.	20.	26.	32.	38.	44.
3.	9.	15.	21.	27.	33.	39.	45.
4.	10.	16.	22.	28.	34.	40.	46.
5.	11.	17.	23.	29.	35.	41.	47.
6.	12.	18.	24.	30.	36.	42.	48.

**ARCHITECTURAL REQUIREMENTS**

<b>WALL AND CEILING</b> Wall Material: <input type="text" value="ARGB 1.2m AFF, GB above"/> Finish: <input type="text" value="PT"/> Ceiling Material: <input type="text" value="ACT"/> Finish: <input type="text" value="PF"/>	<b>WALL PROTECTION</b> Type: <input type="text" value="RHIS"/> <input checked="" type="checkbox"/> Corner Guards <input type="checkbox"/> Hand Rails <input type="checkbox"/> Bed Bumper / Locator Height: <input type="text" value="2185 mm"/> <input type="checkbox"/> Crash Rails <input checked="" type="checkbox"/> Chair Rail	<b>GLAZING</b> <input checked="" type="checkbox"/> Interior Glazing	<b>FLOORING TYPES</b> Material: <input type="text" value="RSF"/> Base: <input type="text" value="RB"/>	<b>ROOM ACCESSORIES</b> <input checked="" type="checkbox"/> Coat Hooks <input type="checkbox"/> Ceiling Lift <input checked="" type="checkbox"/> Magnetic Whiteboard <input type="checkbox"/> Mirror <input type="checkbox"/> Infant Change Table <input type="checkbox"/> Privacy Curtain
--	---	--	---	--

- LEGEND:**
- WALL AND CEILING LEGEND:**
- AC Architectural Ceiling
  - ACT Acoustic Ceiling Tile
  - ACT-C Cleanroom
  - ARGB Abuse-Resistant Gypsum Board
  - GB Gypsum Board
  - IRGB Impact-Resistant Gypsum Board
  - KLCT Kitchen Lay-in Ceiling Tile
  - MMRGB Moisture and Mould-Resistant Gypsum Board
  - SACT Security Acoustic Ceiling Tile
- WALL FINISHES LEGEND:**
- EWC Epoxy Wall Coating
  - HPC High Performance Coating
  - PT Paint
- CEILING FINISHES LEGEND:**
- ECC Epoxy Ceiling Coating
  - HPC High Performance Coating
  - PF Prefinished
  - PT Paint
- WALL PROTECTION LEGEND:**
- ESRP Extruded Semi-Rigid PVCu Panel
  - FRL Fibre Reinforced Laminata
  - FRP Fibreglass Reinforced Plastic
  - PVV Protective Vinyl Wallcovering
  - RHIS Rigid High Impact Sheet
  - WSSP Wetwall Solid Surface Panel
  - WWW Wetroom Vinyl Wallcovering
- FLOOR FINISHES LEGEND:**
- CFS Concrete Floor Sealer
  - EFC Epoxy Floor Coating
  - PFC Polyurethane Floor Coating
  - RAF Rubber Athletic Flooring
  - RSF Rubber Sheet Flooring
  - SCF Seamless Cushioned Flooring
  - SDRF Static-Dissipative Rubber Sheet Flooring
  - SDVF Static-Dissipative Vinyl Sheet Flooring
  - VSF Vinyl Sheet Flooring
  - WSVF Wetroom Safety Vinyl Sheet Flooring
- FLOOR BASE LEGEND:**
- FCB Flash Cove Base
  - RB Rubber Base
  - SCF Seamless Cushioned Flooring

**DOORS**

Types:

Type	Qty	Size (mm)	Material	Finish	Side Lt.	Blinds	Protect.	Privacy Film	Function	Card Reader	Mag Lock	Auto Opener	Hold Open	Hinges	Accessory 1	Accessory 2	Accessory 3	Closer
B	1	915 x 2135	Solid Core	FRL	<input type="checkbox"/>	<input type="checkbox"/>	2 High	<input type="checkbox"/>	Storeroom	<input checked="" type="checkbox"/>	<input type="checkbox"/>	<input type="checkbox"/>	<input checked="" type="checkbox"/>	Butt Hinge				Surface

Door Remarks:  Security Grille  Anti-barricade strategy

**MILLWORK AND SPECIALTY CASEWORK**

Storage Requirements: Refer to Schedule 1 for Digital Device Locker requirements.

**UPPER UNITS** (U1-U8)

**LOWER UNITS** (L1-L12)

**RECEPTION/TRANSACTION COUNTER / CARE TEAM STATION DESK** (TC1, TC2)

**UTILITY SINK AND COUNTER UNIT** (UC1)

**FINISHES**

Full-height Cabinet:	Plastic Laminate
Upper Millwork:	Plastic Laminate
Countertop:	Hardwood
Lower Millwork:	Plastic Laminate
Shelf:	

Remarks: Refer to Schedule 1, Section 6.12 (Division 12) for Specialty Casework. Items indicated are diagrammatic, provide specialty casework appropriate for the specific and specialized functions to be performed in the space and to accommodate Equipment. Refer to Appendix 1A, Section 2.23.4 W4. FMO/AM for reception requirements

**MECHANICAL REQUIREMENTS**

<b>PLUMBING</b> (Quantity) Hand Hygiene Sink: <input type="text"/> Lavatory: <input type="text"/> Kitchen Sink: <input type="text"/> Seamless Kitchen Sink: <input type="text"/> Utility / Process Sink: <input type="text"/> Scrub Sink: <input type="text"/> Floor Sink: <input type="text"/> Plumbing Remarks: <input type="text"/>	Other Fixtures: <input type="checkbox"/> Shower <input type="checkbox"/> Eyewash Station <input type="checkbox"/> Tub <input type="checkbox"/> Eyewash/Shower Station <input type="checkbox"/> Ice Maker <input type="checkbox"/> Emergency Shower <input type="checkbox"/> Water Closet <input type="checkbox"/> Flush Rim Sink <input type="checkbox"/> Instantaneous Hot Water <input type="checkbox"/> Floor Drain <input type="checkbox"/> <input type="checkbox"/> Water Bottle Refill Station Other: <input type="text"/>	<b>MED / NON-MED GASES</b> (Quantity) Oxygen: <input type="text"/> Medical Air: <input type="text"/> Medical Vacuum: <input type="text"/> Nitrous Oxide: <input type="text"/> CO2: <input type="text"/> AGSS: <input type="text"/> Nitrogen: <input type="text"/> Laboratory Air: <input type="text"/> Laboratory Vacuum: <input type="text"/> Utility Compressed Air: <input type="text"/> Gas Remarks: <input type="text"/>
---	---	---



# Appendix 1B Minimum Room Requirements

Room Name:

Program Number(s):

1. W4.02	7.	13.	19.	25.	31.	37.	43.
2.	8.	14.	20.	26.	32.	38.	44.
3.	9.	15.	21.	27.	33.	39.	45.
4.	10.	16.	22.	28.	34.	40.	46.
5.	11.	17.	23.	29.	35.	41.	47.
6.	12.	18.	24.	30.	36.	42.	48.

## ARCHITECTURAL REQUIREMENTS

<b>WALL AND CEILING</b> Wall Material: <input type="text" value="ARGB"/> Finish: <input type="text" value="PT"/> Ceiling Material: <input type="text" value="ACT"/> Finish: <input type="text" value="PF"/>	<b>WALL PROTECTION</b> Type: <input type="text" value="RHIS"/> <input checked="" type="checkbox"/> Corner Guards <input type="checkbox"/> Hand Rails <input type="checkbox"/> Bed Bumper / Locator Height: <input type="text" value="2480 mm"/> <input type="checkbox"/> Crash Rails <input type="checkbox"/> Chair Rail	<b>GLAZING</b> <input type="checkbox"/> Interior Glazing	<b>FLOORING TYPES</b> Material: <input type="text" value="CFS"/> Base: <input type="text" value="FCB"/>	<b>ROOM ACCESSORIES</b> <input checked="" type="checkbox"/> Coat Hooks <input type="checkbox"/> Ceiling Lift <input checked="" type="checkbox"/> Magnetic Whiteboard <input type="checkbox"/> Mirror <input type="checkbox"/> Infant Change Table <input type="checkbox"/> Privacy Curtain
---	--	---	--	--

- LEGEND:**
- WALL AND CEILING LEGEND:**
- AC Architectural Ceiling
  - ACT Acoustic Ceiling Tile
  - ACT-C Cleanroom
  - ARGB Abuse-Resistant Gypsum Board
  - GB Gypsum Board
  - IRGB Impact-Resistant Gypsum Board
  - KLCT Kitchen Lay-in Ceiling Tile
  - MMRGB Moisture and Mould-Resistant Gypsum Board
  - SACT Security Acoustic Ceiling Tile
- WALL FINISHES LEGEND:**
- EWC Epoxy Wall Coating
  - HPC High Performance Coating
  - PT Paint
- CEILING FINISHES LEGEND:**
- ECC Epoxy Ceiling Coating
  - HPC High Performance Coating
  - PF Prefinished
  - PT Paint
- WALL PROTECTION LEGEND:**
- ESRP Extruded Semi-Rigid PVCu Panel
  - FRL Fibre Reinforced Laminate
  - FRP Fibreglass Reinforced Plastic
  - PVV Protective Vinyl Wallcovering
  - RHIS Rigid High Impact Sheet
  - WSSP Wetwall Solid Surface Panel
  - WVV Wetroom Vinyl Wallcovering
- FLOOR FINISHES LEGEND:**
- CFS Concrete Floor Sealer
  - EFC Epoxy Floor Coating
  - PFC Polyurethane Floor Coating
  - RAF Rubber Athletic Flooring
  - RSF Rubber Sheet Flooring
  - SCF Seamless Cushioned Flooring
  - SDRF Static-Dissipative Rubber Sheet Flooring
  - SDVF Static-Dissipative Vinyl Sheet Flooring
  - VSF Vinyl Sheet Flooring
  - WSVF Wetroom Safety Vinyl Sheet Flooring
- FLOOR BASE LEGEND:**
- FCB Flash Cove Base
  - RB Rubber Base
  - SCF Seamless Cushioned Flooring

**DOORS**

Types:

Type	Qty	Size (mm)	Material	Finish	Side Lt.	Blinds	Protect.	Privacy Film	Function	Card Reader	Mag Lock	Auto Opener	Hold Open	Hinges	Accessory 1	Accessory 2	Accessory 3	Closer
C2	1	1830 x 2440	Hollow Metal	Paint	<input type="checkbox"/>	<input type="checkbox"/>		<input type="checkbox"/>	Storeroom	<input checked="" type="checkbox"/>	<input type="checkbox"/>	<input type="checkbox"/>	<input checked="" type="checkbox"/>	Butt Hinge	Astragal	Flush Bolt		Surface

Door Remarks:  Security Grille  Anti-barricade strategy

**MILLWORK AND SPECIALTY CASEWORK**

Storage Requirements:

**UPPER UNITS** (U1-U8)

**LOWER UNITS** (L1-L12)

**RECEPTION/TRANSACTION COUNTER / CARE TEAM STATION DESK** (TC1, TC2)

**UTILITY SINK AND COUNTER UNIT** (UC1)

**SHELF** (S1)

**FULL-HEIGHT CABINETS** (C1-C5)

Category	Min. Length (mm)	Motorized Adjustable Height	Standing Height	Specialty Casework
2	9000	<input checked="" type="checkbox"/>	<input checked="" type="checkbox"/>	<input type="checkbox"/>

**FINISHES**

Full-height Cabinet:

Upper Millwork:

Countertop:

Lower Millwork:

Shelf:

Remarks:

## MECHANICAL REQUIREMENTS

<b>PLUMBING</b> (Quantity) Hand Hygiene Sink: <input type="text" value="1"/> Lavatory: <input type="text"/> Kitchen Sink: <input type="text"/> Seamless Kitchen Sink: <input type="text"/> Utility / Process Sink: <input type="text" value="1"/> Scrub Sink: <input type="text"/> Floor Sink: <input type="text"/> Plumbing Remarks: <input type="text"/>	Other Fixtures: <input type="checkbox"/> Shower <input type="checkbox"/> Tub <input type="checkbox"/> Ice Maker <input type="checkbox"/> Water Closet <input type="checkbox"/> Instantaneous Hot Water <input checked="" type="checkbox"/> Eyewash Station <input type="checkbox"/> Eyewash/Shower Station <input type="checkbox"/> Emergency Shower <input type="checkbox"/> Flush Rim Sink <input checked="" type="checkbox"/> Floor Drain <input type="checkbox"/> Water Bottle Refill Station Other: <input type="text"/>	<b>MED / NON-MED GASES</b> (Quantity) Oxygen: <input type="text"/> Medical Air: <input type="text"/> Medical Vacuum: <input type="text"/> Nitrous Oxide: <input type="text"/> CO2: <input type="text"/> AGSS: <input type="text"/> Nitrogen: <input type="text"/> Laboratory Air: <input type="text"/> Laboratory Vacuum: <input type="text"/> Utility Compressed Air: <input type="text" value="2"/> Gas Remarks: <input type="text"/>
---	---	---

**Appendix 1B Minimum Room Requirements**

Room Name:

Program Number(s):

1. W4.01	7.	13.	19.	25.	31.	37.	43.
2.	8.	14.	20.	26.	32.	38.	44.
3.	9.	15.	21.	27.	33.	39.	45.
4.	10.	16.	22.	28.	34.	40.	46.
5.	11.	17.	23.	29.	35.	41.	47.
6.	12.	18.	24.	30.	36.	42.	48.

**ARCHITECTURAL REQUIREMENTS**

<b>WALL AND CEILING</b> Wall Material: <input type="text" value="ARGB"/> Finish: <input type="text" value="PT"/> Ceiling Material: <input type="text" value="ACT"/> Finish: <input type="text" value="PF"/>	<b>WALL PROTECTION</b> Type: <input type="text" value="RHIS"/> <input checked="" type="checkbox"/> Corner Guards <input type="checkbox"/> Hand Rails <input type="checkbox"/> Bed Bumper / Locator Height: <input type="text" value="2480 mm"/> <input type="checkbox"/> Crash Rails <input type="checkbox"/> Chair Rail	<b>GLAZING</b> <input type="checkbox"/> Interior Glazing	<b>FLOORING TYPES</b> Material: <input type="text" value="CFS"/> Base: <input type="text" value="FCB"/>	<b>ROOM ACCESSORIES</b> <input checked="" type="checkbox"/> Coat Hooks <input checked="" type="checkbox"/> Ceiling Lift <input checked="" type="checkbox"/> Magnetic Whiteboard <input type="checkbox"/> Mirror <input type="checkbox"/> Infant Change Table <input type="checkbox"/> Privacy Curtain
---	--	---	--	---

- LEGEND:**
- WALL AND CEILING LEGEND:**
- AC Architectural Ceiling
  - ACT Acoustic Ceiling Tile
  - ACT-C Cleanroom
  - ARGB Abuse-Resistant Gypsum Board
  - GB Gypsum Board
  - IRGB Impact-Resistant Gypsum Board
  - KLCT Kitchen Lay-in Ceiling Tile
  - MMRGB Moisture and Mould-Resistant Gypsum Board
  - SACT Security Acoustic Ceiling Tile
- WALL FINISHES LEGEND:**
- EWC Epoxy Wall Coating
  - HPC High Performance Coating
  - PT Paint
- CEILING FINISHES LEGEND:**
- ECC Epoxy Ceiling Coating
  - HPC High Performance Coating
  - PF Prefinished
  - PT Paint
- WALL PROTECTION LEGEND:**
- ESRP Extruded Semi-Rigid PVCu Panel
  - FRL Fibre Reinforced Laminate
  - FRP Fibreglass Reinforced Plastic
  - PVV Protective Vinyl Wallcovering
  - RHIS Rigid High Impact Sheet
  - WSSP Wetwall Solid Surface Panel
  - WVV Wetroom Vinyl Wallcovering
- FLOOR FINISHES LEGEND:**
- CFS Concrete Floor Sealer
  - EFC Epoxy Floor Coating
  - PFC Polyurethane Floor Coating
  - RAF Rubber Athletic Flooring
  - RSF Rubber Sheet Flooring
  - SCF Seamless Cushioned Flooring
  - SDRF Static-Dissipative Rubber Sheet Flooring
  - SDVF Static-Dissipative Vinyl Sheet Flooring
  - VSF Vinyl Sheet Flooring
  - WSVF Wetroom Safety Vinyl Sheet Flooring
- FLOOR BASE LEGEND:**
- FCB Flash Cove Base
  - RB Rubber Base
  - SCF Seamless Cushioned Flooring

**DOORS**

Types:

Type	Qty	Size (mm)	Material	Finish	Side Lt.	Blinds	Protect.	Privacy Film	Function	Card Reader	Mag Lock	Auto Opener	Hold Open	Hinges	Accessory 1	Accessory 2	Accessory 3	Closer
C2	1	1830 x 2440	Hollow Metal	Paint	<input type="checkbox"/>	<input type="checkbox"/>		<input type="checkbox"/>	Storeroom	<input checked="" type="checkbox"/>	<input type="checkbox"/>	<input type="checkbox"/>	<input checked="" type="checkbox"/>	Butt Hinge	Astragal	Flush Bolt		Surface

Door Remarks:  Security Grille  Anti-barricade strategy

**MILLWORK AND SPECIALTY CASEWORK**

Storage Requirements: Refer to Schedule 1 for Digital Device Locker requirements.

**UPPER UNITS** (U1-U8)

**LOWER UNITS** (L1-L12)

**RECEPTION/TRANSACTION COUNTER / CARE TEAM STATION DESK** (TC1, TC2)

**UTILITY SINK AND COUNTER UNIT** (UC1)

**FINISHES**

- Full-height Cabinet:
- Upper Millwork:
- Countertop:
- Lower Millwork:
- Shelf:

Remarks:

Category	Min. Length (mm)	Motorized Adjustable Height	Standing Height	Specialty Casework
1	7200	<input checked="" type="checkbox"/>	<input checked="" type="checkbox"/>	<input type="checkbox"/>

**MECHANICAL REQUIREMENTS**

**PLUMBING**

Hand Hygiene Sink: <input type="text" value="1"/>	Lavatory: <input type="text"/>	Kitchen Sink: <input type="text"/>	Seamless Kitchen Sink: <input type="text"/>	Utility / Process Sink: <input type="text" value="1"/>	Scrub Sink: <input type="text"/>	Floor Sink: <input type="text"/>
---	--------------------------------	------------------------------------	---	--	----------------------------------	----------------------------------

Plumbing Remarks:

**Other Fixtures:**

- Shower
- Tub
- Ice Maker
- Water Closet
- Instantaneous Hot Water
- Ewewash Station
- Eyewash/Shower Station
- Emergency Shower
- Flush Rim Sink
- Floor Drain
- Water Bottle Refill Station
- Other:

**MED / NON-MED GASES**

Oxygen:	Medical Air:	Medical Vacuum:	Nitrous Oxide:	CO2:	AGSS:	Nitrogen:	Laboratory Air:	Laboratory Vacuum:	Utility Compressed Air:
<input type="text"/>	<input type="text"/>	<input type="text"/>	<input type="text"/>	<input type="text"/>	<input type="text"/>	<input type="text"/>	<input type="text"/>	<input type="text"/>	<input type="text" value="6"/>

Gas Remarks:

# Appendix 1B Minimum Room Requirements

Room Name:

Program Number(s):

1. W4.04	7.	13.	19.	25.	31.	37.	43.
2.	8.	14.	20.	26.	32.	38.	44.
3.	9.	15.	21.	27.	33.	39.	45.
4.	10.	16.	22.	28.	34.	40.	46.
5.	11.	17.	23.	29.	35.	41.	47.
6.	12.	18.	24.	30.	36.	42.	48.

## ARCHITECTURAL REQUIREMENTS

<b>WALL AND CEILING</b> Wall Material: <input type="text" value="ARGB"/> Finish: <input type="text" value="PT"/> Ceiling Material: <input type="text" value="ACT"/> Finish: <input type="text" value="PF"/>	<b>WALL PROTECTION</b> Type: <input type="text" value="RHIS"/> <input checked="" type="checkbox"/> Corner Guards <input type="checkbox"/> Hand Rails <input type="checkbox"/> Bed Bumper / Locator Height: <input type="text" value="2480 mm"/> <input type="checkbox"/> Crash Rails <input type="checkbox"/> Chair Rail	<b>GLAZING</b> <input type="checkbox"/> Interior Glazing	<b>FLOORING TYPES</b> Material: <input type="text" value="CFS"/> Base: <input type="text" value="FCB"/>	<b>ROOM ACCESSORIES</b> <input checked="" type="checkbox"/> Coat Hooks <input type="checkbox"/> Ceiling Lift <input checked="" type="checkbox"/> Magnetic Whiteboard <input type="checkbox"/> Mirror <input type="checkbox"/> Infant Change Table <input type="checkbox"/> Privacy Curtain
---	--	---	--	--

- LEGEND:**
- WALL AND CEILING LEGEND:**
- AC Architectural Ceiling
  - ACT Acoustic Ceiling Tile
  - ACT-C Cleanroom
  - ARGB Abuse-Resistant Gypsum Board
  - GB Gypsum Board
  - IRGB Impact-Resistant Gypsum Board
  - KLCT Kitchen Lay-in Ceiling Tile
  - MMRGB Moisture and Mould-Resistant Gypsum Board
  - SACT Security Acoustic Ceiling Tile
- WALL FINISHES LEGEND:**
- EWC Epoxy Wall Coating
  - HPC High Performance Coating
  - PT Paint
- CEILING FINISHES LEGEND:**
- ECC Epoxy Ceiling Coating
  - HPC High Performance Coating
  - PF Prefinished
  - PT Paint
- WALL PROTECTION LEGEND:**
- ESRP Extruded Semi-Rigid PVCu Panel
  - FRL Fibre Reinforced Laminate
  - FRP Fibreglass Reinforced Plastic
  - PVV Protective Vinyl Wallcovering
  - RHIS Rigid High Impact Sheet
  - WSSP Wetwall Solid Surface Panel
  - WVV Wetroom Vinyl Wallcovering
- FLOOR FINISHES LEGEND:**
- CFS Concrete Floor Sealer
  - EFC Epoxy Floor Coating
  - PFC Polyurethane Floor Coating
  - RAF Rubber Athletic Flooring
  - RSF Rubber Sheet Flooring
  - SCF Seamless Cushioned Flooring
  - SDRF Static-Dissipative Rubber Sheet Flooring
  - SDVF Static-Dissipative Vinyl Sheet Flooring
  - VSF Vinyl Sheet Flooring
  - WSVF Wetroom Safety Vinyl Sheet Flooring
- FLOOR BASE LEGEND:**
- FCB Flash Cove Base
  - RB Rubber Base
  - SCF Seamless Cushioned Flooring

**DOORS**

Types:

Type	Qty	Size (mm)	Material	Finish	Side Lt.	Blinds	Protect.	Privacy Film	Function	Card Reader	Mag Lock	Auto Opener	Hold Open	Hinges	Accessory 1	Accessory 2	Accessory 3	Closer
C2	2	1830 x 2440	Hollow Metal	Paint	<input type="checkbox"/>	<input type="checkbox"/>		<input type="checkbox"/>	Storeroom	<input checked="" type="checkbox"/>	<input type="checkbox"/>	<input type="checkbox"/>	<input checked="" type="checkbox"/>	Butt Hinge	Astragal	Flush Bolt		Surface

Door Remarks:  Security Grille  Anti-barricade strategy

**MILLWORK AND SPECIALTY CASEWORK**

Storage Requirements:

**UPPER UNITS** (U1-U8)

**LOWER UNITS** (L1-L12)

**RECEPTION/TRANSACTION COUNTER / CARE TEAM STATION DESK** (TC1, TC2)

**UTILITY SINK AND COUNTER UNIT** (UC1)

**SHelf** (S1)

**Full-height Cabinets** (C1-C5)

Category	Min. Length (mm)	Motorized Adjustable Height	Standing Height	Specialty Casework
2	7200	<input checked="" type="checkbox"/>	<input checked="" type="checkbox"/>	<input type="checkbox"/>

**FINISHES**

Full-height Cabinet:

Upper Millwork:

Countertop:

Lower Millwork:

Shelf:

Remarks:

## MECHANICAL REQUIREMENTS

**PLUMBING**

(Quantity)	Hand Hygiene Sink:	Lavatory:	Kitchen Sink:	Seamless Kitchen Sink:	Utility / Process Sink:	Scrub Sink:	Floor Sink:
1					1		

Plumbing Remarks:

**Other Fixtures:**

- Shower
- Tub
- Ice Maker
- Water Closet
- Instantaneous Hot Water
- Eyewash Station
- Eyewash/Shower Station
- Emergency Shower
- Flush Rim Sink
- Floor Drain
- Water Bottle Refill Station

Other:

**MED / NON-MED GASES**

(Quantity)	Oxygen:	Medical Air:	Medical Vacuum:	Nitrous Oxide:	CO2:	AGSS:	Nitrogen:	Laboratory Air:	Laboratory Vacuum:	Utility Compressed Air:
										2

Gas Remarks:



---

# New Surrey Hospital & BC Cancer Centre

MINIMUM ROOM REQUIREMENTS

## X. Patient Food Services

---

**Appendix 1B Minimum Room Requirements**

Room Name:

Program Number(s):

1. X2.01.06	7.	13.	19.	25.	31.	37.	43.
2.	8.	14.	20.	26.	32.	38.	44.
3.	9.	15.	21.	27.	33.	39.	45.
4.	10.	16.	22.	28.	34.	40.	46.
5.	11.	17.	23.	29.	35.	41.	47.
6.	12.	18.	24.	30.	36.	42.	48.

**ARCHITECTURAL REQUIREMENTS**

<b>WALL AND CEILING</b> Wall Material: <input type="text" value="MMRGB"/> Finish: <input type="text" value="HPC"/> Ceiling Material: <input type="text" value="KLCT"/> Finish: <input type="text" value="PF"/>	<b>WALL PROTECTION</b> Type: <input type="text" value="FRP"/> <input type="checkbox"/> Corner Guards <input type="checkbox"/> Hand Rails <input type="checkbox"/> Bed Bumper / Locator Height: <input type="text" value="2185 mm"/> <input type="checkbox"/> Crash Rails <input type="checkbox"/> Chair Rail	<b>GLAZING</b> <input type="checkbox"/> Interior Glazing	<b>FLOORING TYPES</b> Material: <input type="text" value="PFC"/> Base: <input type="text" value="FCB"/>	<b>ROOM ACCESSORIES</b> <input type="checkbox"/> Coat Hooks <input type="checkbox"/> Ceiling Lift <input type="checkbox"/> Magnetic Whiteboard <input type="checkbox"/> Mirror <input type="checkbox"/> Infant Change Table <input type="checkbox"/> Privacy Curtain
--	--	---	--	--

- LEGEND:**
- WALL AND CEILING LEGEND:**
- AC Architectural Ceiling
  - ACT Acoustic Ceiling Tile
  - ACT-C Cleanroom
  - ARGB Abuse-Resistant Gypsum Board
  - GB Gypsum Board
  - IRGB Impact-Resistant Gypsum Board
  - KLCT Kitchen Lay-in Ceiling Tile
  - MMRGB Moisture and Mould-Resistant Gypsum Board
  - SACT Security Acoustic Ceiling Tile
- WALL FINISHES LEGEND:**
- EWC Epoxy Wall Coating
  - HPC High Performance Coating
  - PT Paint
- CEILING FINISHES LEGEND:**
- ECC Epoxy Ceiling Coating
  - HPC High Performance Coating
  - PF Prefinished
  - PT Paint
- WALL PROTECTION LEGEND:**
- ESRP Extruded Semi-Rigid PVCu Panel
  - FRL Fibre Reinforced Laminate
  - FRP Fibreglass Reinforced Plastic
  - PVV Protective Vinyl Wallcovering
  - RHIS Rigid High Impact Sheet
  - WSSP Wetwall Solid Surface Panel
  - WVV Wetroom Vinyl Wallcovering
- FLOOR FINISHES LEGEND:**
- CFS Concrete Floor Sealer
  - EFC Epoxy Floor Coating
  - PFC Polyurethane Floor Coating
  - RAF Rubber Athletic Flooring
  - RSF Rubber Sheet Flooring
  - SCF Seamless Cushioned Flooring
  - SDRF Static-Dissipative Rubber Sheet Flooring
  - SDVF Static-Dissipative Vinyl Sheet Flooring
  - VSF Vinyl Sheet Flooring
  - WSVF Wetroom Safety Vinyl Sheet Flooring
- FLOOR BASE LEGEND:**
- FCB Flash Cove Base
  - RB Rubber Base
  - SCF Seamless Cushioned Flooring

**DOORS**

Types:

Type	Qty	Size (mm)	Material	Finish	Side Lt.	Blinds	Protect.	Privacy Film	Function	Card Reader	Mag Lock	Auto Opener	Hold Open	Hinges	Accessory 1	Accessory 2	Accessory 3	Closer

Door Remarks:  Security Grille  Anti-barricade strategy

**MILLWORK AND SPECIALTY CASEWORK**

Storage Requirements:

**UPPER UNITS** (U1-U8) **SHELF** (S1)

**LOWER UNITS** (L1-L12) **RECEPTION/TRANSACTION COUNTER / CARE TEAM STATION DESK** (TC1-TC2) **UTILITY SINK AND COUNTER UNIT** (UC1)

**FULL-HEIGHT CABINETS** (C1-C5)

**Legend:**

Category	Min. Length (mm)	Motorized Adjustable Height	Standing Height	Specialty Casework
Category 0 - None				
Category 1 - Low (1% - 4%)				
Category 2 - Med (5% - 9%)				
Category 3 - High (10% or Greater)				

**FINISHES**

Full-height Cabinet:   
 Upper Millwork:   
 Countertop:   
 Lower Millwork:   
 Shelf:

Remarks:

**MECHANICAL REQUIREMENTS**

**PLUMBING** (Quantity)

Hygiene Sink:	Lavatory:	Kitchen Sink:	Seamless Kitchen Sink:	Utility / Process Sink:	Scrub Sink:	Floor Sink:

Plumbing Remarks:

**Other Fixtures:**

- Shower
- Tub
- Ice Maker
- Water Closet
- Instantaneous Hot Water
- Eyewash Station
- Eyewash/Shower Station
- Emergency Shower
- Flush Rim Sink
- Floor Drain
- Water Bottle Refill Station

Other:

**MED / NON-MED GASES** (Quantity)

Oxygen:	Medical Air:	Medical Vacuum:	Nitrous Oxide:	CO2:	AGSS:	Nitrogen:	Laboratory Air:	Laboratory Vacuum:	Utility Compressed Air:

Gas Remarks:

**Appendix 1B Minimum Room Requirements**

Room Name:

Program Number(s):

1.	X3.02.03	7.		13.		19.		25.		31.		37.		43.
2.		8.		14.		20.		26.		32.		38.		44.
3.		9.		15.		21.		27.		33.		39.		45.
4.		10.		16.		22.		28.		34.		40.		46.
5.		11.		17.		23.		29.		35.		41.		47.
6.		12.		18.		24.		30.		36.		42.		48.

**ARCHITECTURAL REQUIREMENTS**

<b>WALL AND CEILING</b> Wall Material: <input type="text" value="MMRGB"/> Finish: <input type="text" value="HPC"/> Ceiling Material: <input type="text" value="KLCT"/> Finish: <input type="text" value="PF"/>		<b>WALL PROTECTION</b> Type: <input type="text" value="FRP"/> <input checked="" type="checkbox"/> Corner Guards <input type="checkbox"/> Hand Rails <input type="checkbox"/> Bed Bumper / Locator Height: <input type="text" value="2185 mm"/> <input type="checkbox"/> Crash Rails <input type="checkbox"/> Chair Rail		<b>GLAZING</b> <input type="checkbox"/> Interior Glazing		<b>FLOORING TYPES</b> Material: <input type="text" value="PFC"/> Base: <input type="text" value="FCB"/>		<b>ROOM ACCESSORIES</b> <input type="checkbox"/> Coat Hooks <input type="checkbox"/> Ceiling Lift <input type="checkbox"/> Magnetic Whiteboard <input type="checkbox"/> Mirror <input type="checkbox"/> Infant Change Table <input type="checkbox"/> Privacy Curtain		
--	--	---	--	---	--	--	--	--	--	--

- LEGEND:**
- WALL AND CEILING LEGEND:**
- AC Architectural Ceiling
  - ACT Acoustic Ceiling Tile
  - ACT-C Cleanroom
  - ARGB Abuse-Resistant Gypsum Board
  - GB Gypsum Board
  - IRGB Impact-Resistant Gypsum Board
  - KLCT Kitchen Lay-in Ceiling Tile
  - MMRGB Moisture and Mould-Resistant Gypsum Board
  - SACT Security Acoustic Ceiling Tile
- WALL FINISHES LEGEND:**
- EWC Epoxy Wall Coating
  - HPC High Performance Coating
  - PT Paint
- CEILING FINISHES LEGEND:**
- ECC Epoxy Ceiling Coating
  - HPC High Performance Coating
  - PF Prefinished
  - PT Paint
- WALL PROTECTION LEGEND:**
- ESRP Extruded Semi-Rigid PVCu Panel
  - FRL Fibre Reinforced Laminate
  - FRP Fibreglass Reinforced Plastic
  - PVV Protective Vinyl Wallcovering
  - RHIS Rigid High Impact Sheet
  - WSSP Wetwall Solid Surface Panel
  - WWW Wetroom Vinyl Wallcovering
- FLOOR FINISHES LEGEND:**
- CFS Concrete Floor Sealer
  - EFC Epoxy Floor Coating
  - PFC Polyurethane Floor Coating
  - RAF Rubber Athletic Flooring
  - RSF Rubber Sheet Flooring
  - SCF Seamless Cushioned Flooring
  - SDRF Static-Dissipative Rubber Sheet Flooring
  - SDVF Static-Dissipative Vinyl Sheet Flooring
  - VSF Vinyl Sheet Flooring
  - WSVF Wetroom Safety Vinyl Sheet Flooring
- FLOOR BASE LEGEND:**
- FCB Flash Cove Base
  - RB Rubber Base
  - SCF Seamless Cushioned Flooring

**DOORS**

Types:

Type	Qty	Size (mm)	Material	Finish	Side Lt.	Blinds	Protect.	Privacy Film	Function	Card Reader	Mag Lock	Auto Opener	Hold Open	Hinges	Accessory 1	Accessory 2	Accessory 3	Closer

Door Remarks:  Security Grille  Anti-barricade strategy

**MILLWORK AND SPECIALTY CASEWORK**

**UPPER UNITS** (U1-U8) **LOWER UNITS** (L1-L12) **RECEPTION/TRANSACTION COUNTER / CARE TEAM STATION DESK** (TC1-TC2) **UTILITY SINK AND COUNTER UNIT** (UC1)

Storage Requirements:  SHELF (S1)

**FULL-HEIGHT CABINETS** (C1-C5)

Category	Min. Length (mm)	Motorized Adjustable Height	Standing Height	Specialty Casework
Category 0 - None				
Category 1 - Low (1% - 4%)				
Category 2 - Med (5% - 9%)				
Category 3 - High (10% or Greater)				

**FINISHES**

Full-height Cabinet:   
 Upper Millwork:   
 Countertop:   
 Lower Millwork:   
 Shelf:

Remarks: Floor depression to accommodate custom fabricated trench drain(s), length and width to suit design x 150mm deep as noted in Appendix 11 [Food Service Equipment Specifications.]

**MECHANICAL REQUIREMENTS**

<b>PLUMBING</b> (Quantity) Hand Hygiene Sink: <input type="text"/> Lavatory: <input type="text"/> Kitchen Sink: <input type="text"/> Seamless Kitchen Sink: <input type="text"/> Utility / Process Sink: <input type="text"/> Scrub Sink: <input type="text"/> Floor Sink: <input type="text"/>							Other Fixtures: <input type="checkbox"/> Shower <input type="checkbox"/> Eyewash Station <input type="checkbox"/> Tub <input type="checkbox"/> Eyewash/Shower Station <input type="checkbox"/> Ice Maker <input type="checkbox"/> Emergency Shower <input type="checkbox"/> Water Closet <input type="checkbox"/> Flush Rim Sink <input type="checkbox"/> Instantaneous Hot Water <input type="checkbox"/> Floor Drain <input type="checkbox"/> Water Bottle Refill Station				<b>MED / NON-MED GASES</b> (Quantity) Oxygen: <input type="text"/> Medical Air: <input type="text"/> Medical Vacuum: <input type="text"/> Nitrous Oxide: <input type="text"/> CO2: <input type="text"/> AGSS: <input type="text"/> Nitrogen: <input type="text"/> Laboratory Air: <input type="text"/> Laboratory Vacuum: <input type="text"/> Utility Compressed Air: <input type="text"/>				
Plumbing Remarks: <input type="text" value="Trench drains to direct drain to grease trap."/>							Gas Remarks: <input type="text"/>								



**Appendix 1B Minimum Room Requirements**

Room Name:

Program Number(s):

1.	X3.03	7.		13.		19.		25.		31.		37.		43.
2.		8.		14.		20.		26.		32.		38.		44.
3.		9.		15.		21.		27.		33.		39.		45.
4.		10.		16.		22.		28.		34.		40.		46.
5.		11.		17.		23.		29.		35.		41.		47.
6.		12.		18.		24.		30.		36.		42.		48.

**ARCHITECTURAL REQUIREMENTS**

<b>WALL AND CEILING</b> Wall Material: <input type="text" value="ARGB 1.2m AFF, GB above"/> Finish: <input type="text" value="HPC"/> Ceiling Material: <input type="text" value="KLCT"/> Finish: <input type="text" value="PF"/>		<b>WALL PROTECTION</b> Type: <input type="text" value="PVW"/> <input checked="" type="checkbox"/> Corner Guards <input type="checkbox"/> Hand Rails <input type="checkbox"/> Bed Bumper / Locator Height: <input type="text" value="2185 mm"/> <input checked="" type="checkbox"/> Crash Rails <input type="checkbox"/> Chair Rail		<b>GLAZING</b> <input type="checkbox"/> Interior Glazing		<b>FLOORING TYPES</b> Material: <input type="text" value="PFC"/> Base: <input type="text" value="FCB"/>		<b>ROOM ACCESSORIES</b> <input type="checkbox"/> Coat Hooks <input type="checkbox"/> Ceiling Lift <input type="checkbox"/> Magnetic Whiteboard <input type="checkbox"/> Mirror <input type="checkbox"/> Infant Change Table <input type="checkbox"/> Privacy Curtain	
--	--	--	--	---	--	--	--	--	--

- LEGEND:**
- WALL AND CEILING LEGEND:**
- AC Architectural Ceiling
  - ACT Acoustic Ceiling Tile
  - ACT-C Cleanroom
  - ARGB Abuse-Resistant Gypsum Board
  - GB Gypsum Board
  - IRGB Impact-Resistant Gypsum Board
  - KLCT Kitchen Lay-in Ceiling Tile
  - MMRGB Moisture and Mould-Resistant Gypsum Board
  - SACT Security Acoustic Ceiling Tile
- WALL FINISHES LEGEND:**
- EWC Epoxy Wall Coating
  - HPC High Performance Coating
  - PT Paint
- CEILING FINISHES LEGEND:**
- ECC Epoxy Ceiling Coating
  - HPC High Performance Coating
  - PF Prefinished
  - PT Paint
- WALL PROTECTION LEGEND:**
- ESRP Extruded Semi-Rigid PVCu Panel
  - FRL Fibre Reinforced Laminate
  - FRP Fibreglass Reinforced Plastic
  - PVW Protective Vinyl Wallcovering
  - RHIS Rigid High Impact Sheet
  - WSSP Wetwall Solid Surface Panel
  - WVV Wetroom Vinyl Wallcovering
- FLOOR FINISHES LEGEND:**
- CFS Concrete Floor Sealer
  - EFC Epoxy Floor Coating
  - PFC Polyurethane Floor Coating
  - RAF Rubber Athletic Flooring
  - RSF Rubber Sheet Flooring
  - SCF Seamless Cushioned Flooring
  - SDRF Static-Dissipative Rubber Sheet Flooring
  - SDVF Static-Dissipative Vinyl Sheet Flooring
  - VSF Vinyl Sheet Flooring
  - WSVF Wetroom Safety Vinyl Sheet Flooring
- FLOOR BASE LEGEND:**
- FCB Flash Cove Base
  - RB Rubber Base
  - SCF Seamless Cushioned Flooring

**DOORS**

Types:

Type	Qty	Size (mm)	Material	Finish	Side Lt.	Blinds	Protect.	Privacy Film	Function	Card Reader	Mag Lock	Auto Opener	Hold Open	Hinges	Accessory 1	Accessory 2	Accessory 3	Closer
C2	1	1830 x 2135	Hollow Metal	Paint	<input type="checkbox"/>	<input type="checkbox"/>	2 High	<input checked="" type="checkbox"/>	Storeroom	<input checked="" type="checkbox"/>	<input type="checkbox"/>	<input checked="" type="checkbox"/>	<input type="checkbox"/>	Butt Hinge	Astragal	Flush Bolt	Elec. Strike	Surface

Door Remarks:  Security Grille  Anti-barricade strategy



**MECHANICAL REQUIREMENTS**

<b>PLUMBING</b> (Quantity) Hand Hygiene Sink: <input type="text"/> Lavatory: <input type="text"/> Kitchen Sink: <input type="text"/> Seamless Kitchen Sink: <input type="text"/> Utility / Process Sink: <input type="text"/> Scrub Sink: <input type="text"/> Floor Sink: <input type="text"/> Plumbing Remarks: <input type="text"/>		Other Fixtures: <input type="checkbox"/> Shower <input type="checkbox"/> Eyewash Station <input type="checkbox"/> Tub <input type="checkbox"/> Eyewash/Shower Station <input type="checkbox"/> Ice Maker <input type="checkbox"/> Emergency Shower <input type="checkbox"/> Water Closet <input checked="" type="checkbox"/> Floor Drain <input type="checkbox"/> Instantaneous Hot Water <input type="checkbox"/> Water Bottle Refill Station Other: <input type="text"/>		<b>MED / NON-MED GASES</b> (Quantity) Oxygen: <input type="text"/> Medical Air: <input type="text"/> Medical Vacuum: <input type="text"/> Nitrous Oxide: <input type="text"/> CO2: <input type="text"/> AGSS: <input type="text"/> Nitrogen: <input type="text"/> Laboratory Air: <input type="text"/> Laboratory Vacuum: <input type="text"/> Utility Compressed Air: <input type="text"/> Gas Remarks: <input type="text"/>	
--	--	--	--	--	--

**Appendix 1B Minimum Room Requirements**

Room Name:

Program Number(s):

1. X2.01.05	7.	13.	19.	25.	31.	37.	43.
2.	8.	14.	20.	26.	32.	38.	44.
3.	9.	15.	21.	27.	33.	39.	45.
4.	10.	16.	22.	28.	34.	40.	46.
5.	11.	17.	23.	29.	35.	41.	47.
6.	12.	18.	24.	30.	36.	42.	48.

**ARCHITECTURAL REQUIREMENTS**

<b>WALL AND CEILING</b> Wall Material: <input type="text" value="MMRGB"/> Finish: <input type="text" value="HPC"/> Ceiling Material: <input type="text" value="KLCT"/> Finish: <input type="text" value="PF"/>		<b>WALL PROTECTION</b> Type: <input type="text" value="FRP"/> <input checked="" type="checkbox"/> Corner Guards <input type="checkbox"/> Hand Rails <input type="checkbox"/> Bed Bumper / Locator Height: <input type="text" value="2185 mm"/> <input checked="" type="checkbox"/> Crash Rails <input type="checkbox"/> Chair Rail		<b>GLAZING</b> <input type="checkbox"/> Interior Glazing		<b>FLOORING TYPES</b> Material: <input type="text" value="PFC"/> Base: <input type="text" value="FCB"/>		<b>ROOM ACCESSORIES</b> <input type="checkbox"/> Coat Hooks <input type="checkbox"/> Ceiling Lift <input checked="" type="checkbox"/> Magnetic Whiteboard <input type="checkbox"/> Mirror <input type="checkbox"/> Infant Change Table <input type="checkbox"/> Privacy Curtain	
--	--	--	--	---	--	--	--	---	--

- LEGEND:**
- WALL AND CEILING LEGEND:**
- AC Architectural Ceiling
  - ACT Acoustic Ceiling Tile
  - ACT-C Cleanroom
  - ARGB Abuse-Resistant Gypsum Board
  - GB Gypsum Board
  - IRGB Impact-Resistant Gypsum Board
  - KLCT Kitchen Lay-in Ceiling Tile
  - MMRGB Moisture and Mould-Resistant Gypsum Board
  - SACT Security Acoustic Ceiling Tile
- WALL FINISHES LEGEND:**
- EWC Epoxy Wall Coating
  - HPC High Performance Coating
  - PT Paint
- CEILING FINISHES LEGEND:**
- ECC Epoxy Ceiling Coating
  - HPC High Performance Coating
  - PF Prefinished
  - PT Paint
- WALL PROTECTION LEGEND:**
- ESRP Extruded Semi-Rigid PVCu Panel
  - FRL Fibre Reinforced Laminate
  - FRP Fibreglass Reinforced Plastic
  - PVV Protective Vinyl Wallcovering
  - RHIS Rigid High Impact Sheet
  - WSSP Wetwall Solid Surface Panel
  - WVV Wetroom Vinyl Wallcovering
- FLOOR FINISHES LEGEND:**
- CFS Concrete Floor Sealer
  - EFC Epoxy Floor Coating
  - PFC Polyurethane Floor Coating
  - RAF Rubber Athletic Flooring
  - RSF Rubber Sheet Flooring
  - SCF Seamless Cushioned Flooring
  - SDRF Static-Dissipative Rubber Sheet Flooring
  - SDVF Static-Dissipative Vinyl Sheet Flooring
  - VSF Vinyl Sheet Flooring
  - WSVF Wetroom Safety Vinyl Sheet Flooring
- FLOOR BASE LEGEND:**
- FCB Flash Cove Base
  - RB Rubber Base
  - SCF Seamless Cushioned Flooring

**DOORS**

Types:

Type:Qty:	Size (mm):	Material:	Finish:	Side Lt:	Blinds:	Protect.:	Privacy Film:	Function:	Card Reader:	Mag Lock:	Auto Opener:	Hold Open:	Hinges:	Accessory 1:	Accessory 2:	Accessory 3:	Closer:

Door Remarks:  Security Grille  Anti-barricade strategy



**MECHANICAL REQUIREMENTS**

<b>PLUMBING</b> (Quantity) Hygiene Sink: <input type="text" value="1"/> Lavatory: <input type="text"/> Kitchen Sink: <input type="text"/> Kitchen Sink: <input type="text"/> Process Sink: <input type="text"/> Scrub Sink: <input type="text"/> Floor Sink: <input type="text"/>		Other Fixtures: <input type="checkbox"/> Shower <input type="checkbox"/> Tub <input type="checkbox"/> Ice Maker <input type="checkbox"/> Water Closet <input type="checkbox"/> Instantaneous Hot Water		<input type="checkbox"/> Eyewash Station <input type="checkbox"/> Eyewash/Shower Station <input type="checkbox"/> Emergency Shower <input type="checkbox"/> Flush Rim Sink <input checked="" type="checkbox"/> Floor Drain <input type="checkbox"/> Water Bottle Refill Station		<b>MED / NON-MED GASES</b> (Quantity) Oxygen: <input type="text"/> Medical Air: <input type="text"/> Medical Vacuum: <input type="text"/> Nitrous Oxide: <input type="text"/> CO2: <input type="text"/> AGSS: <input type="text"/> Nitrogen: <input type="text"/> Laboratory Air: <input type="text"/> Laboratory Vacuum: <input type="text"/> Utility Compressed Air: <input type="text"/>	
Plumbing Remarks: <input type="text" value="To accommodate stainless steel work tables with sinks as noted in Appendix 1I Food Service Equipment Specifications."/>		<input type="checkbox"/> Other: <input type="text"/>		Gas Remarks: <input type="text"/>			

**Appendix 1B Minimum Room Requirements**

Room Name:

Program Number(s):

1.	X1.07	7.		13.		19.		25.		31.		37.		43.
2.		8.		14.		20.		26.		32.		38.		44.
3.		9.		15.		21.		27.		33.		39.		45.
4.		10.		16.		22.		28.		34.		40.		46.
5.		11.		17.		23.		29.		35.		41.		47.
6.		12.		18.		24.		30.		36.		42.		48.

**ARCHITECTURAL REQUIREMENTS**

<b>WALL AND CEILING</b> Wall Material: <input type="text" value="MMRGB"/> Finish: <input type="text" value="HPC"/> Ceiling Material: <input type="text" value="KLCT"/> Finish: <input type="text" value="PF"/>		<b>WALL PROTECTION</b> Type: <input type="text" value="FRP"/> <input checked="" type="checkbox"/> Corner Guards <input type="checkbox"/> Hand Rails <input type="checkbox"/> Bed Bumper / Locator Height: <input type="text" value="2185 mm"/> <input type="checkbox"/> Crash Rails <input type="checkbox"/> Chair Rail			<b>GLAZING</b> <input type="checkbox"/> Interior Glazing		<b>FLOORING TYPES</b> Material: <input type="text" value="PFC"/> Base: <input type="text" value="FCB"/>		<b>ROOM ACCESSORIES</b> <input type="checkbox"/> Coat Hooks <input type="checkbox"/> Ceiling Lift <input type="checkbox"/> Magnetic Whiteboard <input type="checkbox"/> Mirror <input type="checkbox"/> Infant Change Table <input type="checkbox"/> Privacy Curtain		
--	--	---	--	--	---	--	--	--	--	--	--

- LEGEND:**
- WALL AND CEILING LEGEND:**
- AC Architectural Ceiling
  - ACT Acoustic Ceiling Tile
  - ACT-C Cleanroom
  - ARGB Abuse-Resistant Gypsum Board
  - GB Gypsum Board
  - IRGB Impact-Resistant Gypsum Board
  - KLCT Kitchen Lay-in Ceiling Tile
  - MMRGB Moisture and Mould-Resistant Gypsum Board
  - SACT Security Acoustic Ceiling Tile
- WALL FINISHES LEGEND:**
- EWC Epoxy Wall Coating
  - HPC High Performance Coating
  - PT Paint
- CEILING FINISHES LEGEND:**
- ECC Epoxy Ceiling Coating
  - HPC High Performance Coating
  - PF Prefinished
  - PT Paint
- WALL PROTECTION LEGEND:**
- ESRP Extruded Semi-Rigid PVCu Panel
  - FRL Fibre Reinforced Laminate
  - FRP Fibreglass Reinforced Plastic
  - PVV Protective Vinyl Wallcovering
  - RHIS Rigid High Impact Sheet
  - WSSP Wetwall Solid Surface Panel
  - WVV Wetroom Vinyl Wallcovering
- FLOOR FINISHES LEGEND:**
- CFS Concrete Floor Sealer
  - EFC Epoxy Floor Coating
  - PFC Polyurethane Floor Coating
  - RAF Rubber Athletic Flooring
  - RSF Rubber Sheet Flooring
  - SCF Seamless Cushioned Flooring
  - SDRF Static-Dissipative Rubber Sheet Flooring
  - SDVF Static-Dissipative Vinyl Sheet Flooring
  - VSF Vinyl Sheet Flooring
  - WSVF Wetroom Safety Vinyl Sheet Flooring
- FLOOR BASE LEGEND:**
- FCB Flash Cove Base
  - RB Rubber Base
  - SCF Seamless Cushioned Flooring

**DOORS**

Types:

Type	Qty	Size (mm)	Material	Finish	Side Lt.	Blinds	Protect.	Privacy Film	Function	Card Reader	Mag Lock	Auto Opener	Hold Open	Hinges	Accessory 1	Accessory 2	Accessory 3	Closer
C	1	1220 x 2135	Solid Core	FRL	<input type="checkbox"/>	<input type="checkbox"/>	2 High	<input type="checkbox"/>	Storeroom	<input checked="" type="checkbox"/>	<input type="checkbox"/>	<input type="checkbox"/>	<input type="checkbox"/>	Butt Hinge				Surface

**Door Remarks:**

Security Grille  
 Anti-barricade strategy

**MILLWORK AND SPECIALTY CASEWORK**

**UPPER UNITS** (U1-U8) **SHELF** (S1)

**LOWER UNITS** (L1-L12) **RECEPTION/TRANSACTION COUNTER / CARE TEAM STATION DESK** (TC1, TC2) **UTILITY SINK AND COUNTER UNIT** (UC1)

**Storage Requirements:**

Category	Min. Length (mm)	Motorized Adjustable Height	Standing Height	Specialty Casework
Category 0 - None		<input type="checkbox"/>	<input type="checkbox"/>	<input type="checkbox"/>
Category 1 - Low (1% - 4%)		<input type="checkbox"/>	<input type="checkbox"/>	<input type="checkbox"/>
Category 2 - Med (5% - 9%)		<input type="checkbox"/>	<input type="checkbox"/>	<input type="checkbox"/>
Category 3 - High (10% or Greater)		<input type="checkbox"/>	<input type="checkbox"/>	<input type="checkbox"/>

**FINISHES**

Full-height Cabinet:   
 Upper Millwork:   
 Countertop:   
 Lower Millwork:   
 Shelf:

**Remarks:**

**MECHANICAL REQUIREMENTS**

<b>PLUMBING</b> (Quantity) Hand Hygiene Sink: <input type="text"/> Lavatory: <input type="text"/> Kitchen Sink: <input type="text"/> Seamless Kitchen Sink: <input type="text"/> Utility / Process Sink: <input type="text"/> Scrub Sink: <input type="text"/> Floor Sink: <input type="text"/>							Other Fixtures: <input type="checkbox"/> Shower <input type="checkbox"/> Eyewash Station <input type="checkbox"/> Tub <input type="checkbox"/> Eyewash/Shower Station <input type="checkbox"/> Ice Maker <input type="checkbox"/> Emergency Shower <input type="checkbox"/> Water Closet <input type="checkbox"/> Flush Rim Sink <input type="checkbox"/> Instantaneous Hot Water <input type="checkbox"/> Floor Drain <input type="checkbox"/> Water Bottle Refill Station Other: <input type="text"/>			<b>MED / NON-MED GASES</b> (Quantity) Oxygen: <input type="text"/> Medical Air: <input type="text"/> Medical Vacuum: <input type="text"/> Nitrous Oxide: <input type="text"/> CO2: <input type="text"/> AGSS: <input type="text"/> Nitrogen: <input type="text"/> Laboratory Air: <input type="text"/> Laboratory Vacuum: <input type="text"/> Utility Compressed Air: <input type="text"/>				
Plumbing Remarks: <div style="border: 1px solid black; height: 50px; width: 100%;"></div>							Gas Remarks: <div style="border: 1px solid black; height: 50px; width: 100%;"></div>							



**Appendix 1B Minimum Room Requirements**

Room Name:

Program Number(s):

1. X3.02.02	7.	13.	19.	25.	31.	37.	43.
2.	8.	14.	20.	26.	32.	38.	44.
3.	9.	15.	21.	27.	33.	39.	45.
4.	10.	16.	22.	28.	34.	40.	46.
5.	11.	17.	23.	29.	35.	41.	47.
6.	12.	18.	24.	30.	36.	42.	48.

**ARCHITECTURAL REQUIREMENTS**

<b>WALL AND CEILING</b> Wall Material: <input type="text" value="MMRGB"/> Finish: <input type="text" value="HPC"/> Ceiling Material: <input type="text" value="KLCT"/> Finish: <input type="text" value="PF"/>	<b>WALL PROTECTION</b> Type: <input type="text" value="FRP"/> <input checked="" type="checkbox"/> Corner Guards <input type="checkbox"/> Hand Rails <input type="checkbox"/> Bed Bumper / Locator Height: <input type="text" value="2185 mm"/> <input type="checkbox"/> Crash Rails <input type="checkbox"/> Chair Rail	<b>GLAZING</b> <input type="checkbox"/> Interior Glazing	<b>FLOORING TYPES</b> Material: <input type="text" value="PFC"/> Base: <input type="text" value="FCB"/>	<b>ROOM ACCESSORIES</b> <input type="checkbox"/> Coat Hooks <input type="checkbox"/> Ceiling Lift <input checked="" type="checkbox"/> Magnetic Whiteboard <input type="checkbox"/> Mirror <input type="checkbox"/> Infant Change Table <input type="checkbox"/> Privacy Curtain
--	---	---	--	---

- LEGEND:**
- WALL AND CEILING LEGEND:**
- AC Architectural Ceiling
  - ACT Acoustic Ceiling Tile
  - ACT-C Cleanroom
  - ARGB Abuse-Resistant Gypsum Board
  - GB Gypsum Board
  - IRGB Impact-Resistant Gypsum Board
  - KLCT Kitchen Lay-in Ceiling Tile
  - MMRGB Moisture and Mould-Resistant Gypsum Board
  - SACT Security Acoustic Ceiling Tile
- WALL FINISHES LEGEND:**
- EWC Epoxy Wall Coating
  - HPC High Performance Coating
  - PT Paint
- CEILING FINISHES LEGEND:**
- ECC Epoxy Ceiling Coating
  - HPC High Performance Coating
  - PF Prefinished
  - PT Paint
- WALL PROTECTION LEGEND:**
- ESRP Extruded Semi-Rigid PVCu Panel
  - FRL Fibre Reinforced Laminate
  - FRP Fibreglass Reinforced Plastic
  - PVV Protective Vinyl Wallcovering
  - RHIS Rigid High Impact Sheet
  - WSSP Wetwall Solid Surface Panel
  - WVV Wetroom Vinyl Wallcovering
- FLOOR FINISHES LEGEND:**
- CFS Concrete Floor Sealer
  - EFC Epoxy Floor Coating
  - PFC Polyurethane Floor Coating
  - RAF Rubber Athletic Flooring
  - RSF Rubber Sheet Flooring
  - SCF Seamless Cushioned Flooring
  - SDRF Static-Dissipative Rubber Sheet Flooring
  - SDVF Static-Dissipative Vinyl Sheet Flooring
  - VSF Vinyl Sheet Flooring
  - WSVF Wetroom Safety Vinyl Sheet Flooring
- FLOOR BASE LEGEND:**
- FCB Flash Cove Base
  - RB Rubber Base
  - SCF Seamless Cushioned Flooring

**DOORS**

Types:

Type	Qty	Size (mm)	Material	Finish	Side Lt.	Blinds	Protect.	Privacy Film	Function	Card Reader	Mag Lock	Auto Opener	Hold Open	Hinges	Accessory 1	Accessory 2	Accessory 3	Closer

Door Remarks:  Security Grille  Anti-barricade strategy

**MILLWORK AND SPECIALTY CASEWORK**

**UPPER UNITS** U1 U2 U3 U4 U5 U6 U7 U8

**LOWER UNITS** L1 L2 L3 L4 L5 L6 L7 L8 L9 L10 L11 L12

**RECEPTION/TRANSACTION COUNTER / CARE TEAM STATION DESK** TC1 TC2

**UTILITY SINK AND COUNTER UNIT** UC1

**Storage Requirements:**

**FINISHES**

Full-height Cabinet:

Upper Millwork:

Countertop:

Lower Millwork:

Shelf:

Remarks:

**Legend:**

Category	Min. Length (mm)	Motorized Adjustable Height	Standing Height	Specialty Casework
Category 0 - None				
Category 1 - Low (1% - 4%)				
Category 2 - Med (5% - 9%)				
Category 3 - High (10% or Greater)				

**MECHANICAL REQUIREMENTS**

**PLUMBING**

Hand Hygiene Sink:  Lavatory:  Kitchen Sink:  Kitchen Sink:  Utility / Process Sink:  Scrub Sink:  Floor Sink:

Plumbing Remarks:

**Other Fixtures:**

- Shower
- Tub
- Ice Maker
- Water Closet
- Instantaneous Hot Water
- Eyewash Station
- Eyewash/Shower Station
- Emergency Shower
- Flush Rim Sink
- Floor Drain
- Water Bottle Refill Station

Other:

**MED / NON-MED GASES**

(Quantity)

Oxygen	Medical Air	Medical Vacuum	Nitrous Oxide	CO2	AGSS	Nitrogen	Laboratory Air	Laboratory Vacuum	Utility Compressed Air
<input type="text"/>	<input type="text"/>	<input type="text"/>	<input type="text"/>	<input type="text"/>	<input type="text"/>	<input type="text"/>	<input type="text"/>	<input type="text"/>	<input type="text"/>

Gas Remarks:

**Appendix 1B Minimum Room Requirements**

Room Name:

Program Number(s):

1. X2.01.04	7.	13.	19.	25.	31.	37.	43.
2.	8.	14.	20.	26.	32.	38.	44.
3.	9.	15.	21.	27.	33.	39.	45.
4.	10.	16.	22.	28.	34.	40.	46.
5.	11.	17.	23.	29.	35.	41.	47.
6.	12.	18.	24.	30.	36.	42.	48.

**ARCHITECTURAL REQUIREMENTS**

<b>WALL AND CEILING</b> Wall Material: <input type="text" value="MMRGB"/> Finish: <input type="text" value="HPC"/> Ceiling Material: <input type="text" value="KLCT"/> Finish: <input type="text" value="PF"/>	<b>WALL PROTECTION</b> Type: <input type="text" value="FRP"/> <input checked="" type="checkbox"/> Corner Guards <input type="checkbox"/> Hand Rails <input type="checkbox"/> Bed Bumper / Locator Height: <input type="text" value="2185 mm"/> <input checked="" type="checkbox"/> Crash Rails <input type="checkbox"/> Chair Rail	<b>GLAZING</b> <input type="checkbox"/> Interior Glazing	<b>FLOORING TYPES</b> Material: <input type="text" value="PFC"/> Base: <input type="text" value="FCB"/>	<b>ROOM ACCESSORIES</b> <input type="checkbox"/> Coat Hooks <input type="checkbox"/> Ceiling Lift <input checked="" type="checkbox"/> Magnetic Whiteboard <input type="checkbox"/> Mirror <input type="checkbox"/> Infant Change Table <input type="checkbox"/> Privacy Curtain
--	--	---	--	---

- LEGEND:**
- WALL AND CEILING LEGEND:**
- AC Architectural Ceiling
  - ACT Acoustic Ceiling Tile
  - ACT-C Cleanroom
  - ARGB Abuse-Resistant Gypsum Board
  - GB Gypsum Board
  - IRGB Impact-Resistant Gypsum Board
  - KLCT Kitchen Lay-in Ceiling Tile
  - MMRGB Moisture and Mould-Resistant Gypsum Board
  - SACT Security Acoustic Ceiling Tile
- WALL FINISHES LEGEND:**
- EWC Epoxy Wall Coating
  - HPC High Performance Coating
  - PT Paint
- CEILING FINISHES LEGEND:**
- ECC Epoxy Ceiling Coating
  - HPC High Performance Coating
  - PF Prefinished
  - PT Paint
- WALL PROTECTION LEGEND:**
- ESRP Extruded Semi-Rigid PVCu Panel
  - FRL Fibre Reinforced Laminate
  - FRP Fibreglass Reinforced Plastic
  - PVV Protective Vinyl Wallcovering
  - RHIS Rigid High Impact Sheet
  - WSSP Wetwall Solid Surface Panel
  - WWW Wetroom Vinyl Wallcovering
- FLOOR FINISHES LEGEND:**
- CFS Concrete Floor Sealer
  - EFC Epoxy Floor Coating
  - PFC Polyurethane Floor Coating
  - RAF Rubber Athletic Flooring
  - RSF Rubber Sheet Flooring
  - SCF Seamless Cushioned Flooring
  - SDRF Static-Dissipative Rubber Sheet Flooring
  - SDVF Static-Dissipative Vinyl Sheet Flooring
  - VSF Vinyl Sheet Flooring
  - WSVF Wetroom Safety Vinyl Sheet Flooring
- FLOOR BASE LEGEND:**
- FCB Flash Cove Base
  - RB Rubber Base
  - SCF Seamless Cushioned Flooring

**DOORS**

Types:

Type:Qty:	Size (mm):	Material:	Finish:	Side Lt:	Blinds:	Protect.:	Privacy Film:	Function:	Card Reader:	Mag Lock:	Auto Opener:	Hold Open:	Hinges:	Accessory 1:	Accessory 2:	Accessory 3:	Closer:

Door Remarks:  Security Grille  Anti-barricade strategy

**MILLWORK AND SPECIALTY CASEWORK**

Storage Requirements:

**UPPER UNITS** U1 U2 U3 U4 U5 U6 U7 U8

**LOWER UNITS** L10 L11 L12

**RECEPTION/TRANSACTION COUNTER / CARE TEAM STATION DESK** TC1 TC2

**UTILITY SINK AND COUNTER UNIT** UC1

**FULL-HEIGHT CABINETS** C1 C2 C3 C4 C5

**SHELF** S1

**Legend:**

Category	Min. Length (mm)	Motorized Adjustable Height	Standing Height	Specialty Casework
Category 0 - None				
Category 1 - Low (1% - 4%)				
Category 2 - Med (5% - 9%)				
Category 3 - High (10% or Greater)				

**FINISHES**

Full-height Cabinet:

Upper Millwork:

Countertop:

Lower Millwork:

Shelf:

Remarks: Floor depression to accommodate custom fabricated trench drain(s), length and width to suit design x 150mm deep as noted in Appendix 11 [Food Service Equipment Specifications.]

**MECHANICAL REQUIREMENTS**

**PLUMBING**

Hand Hygiene Sink:	Lavatory:	Kitchen Sink:	Seamless Kitchen Sink:	Utility / Process Sink:	Scrub Sink:	Floor Sink:
1						

Plumbing Remarks: To accommodate equipment as noted in Appendix 11 Food Service Equipment Specifications. Trench drains(s) - direct drain to grease trap. Provide HHS every 7m.

**Other Fixtures:**

- Shower
- Tub
- Ice Maker
- Water Closet
- Instantaneous Hot Water
- Ewewash Station
- Eyewash/Shower Station
- Emergency Shower
- Flush Rim Sink
- Floor Drain
- Water Bottle Refill Station

Other:

**MED / NON-MED GASES**

Oxygen:	Medical Air:	Medical Vacuum:	Nitrous Oxide:	CO2:	AGSS:	Nitrogen:	Laboratory Air:	Laboratory Vacuum:	Utility Compressed Air:

Gas Remarks:

# Appendix 1B Minimum Room Requirements

Room Name:

Program Number(s):

1.	X2.02	7.		13.		19.		25.		31.		37.		43.
2.		8.		14.		20.		26.		32.		38.		44.
3.		9.		15.		21.		27.		33.		39.		45.
4.		10.		16.		22.		28.		34.		40.		46.
5.		11.		17.		23.		29.		35.		41.		47.
6.		12.		18.		24.		30.		36.		42.		48.

## ARCHITECTURAL REQUIREMENTS

<b>WALL AND CEILING</b> Wall Material: <input type="text" value="MMRGB"/> Finish: <input type="text" value="HPC"/> Ceiling Material: <input type="text" value="KLCT"/> Finish: <input type="text" value="PF"/>	<b>WALL PROTECTION</b> Type: <input type="text" value="FRP"/> <input checked="" type="checkbox"/> Corner Guards <input type="checkbox"/> Hand Rails <input type="checkbox"/> Bed Bumper / Locator Height: <input type="text" value="2185 mm"/> <input type="checkbox"/> Crash Rails <input type="checkbox"/> Chair Rail	<b>GLAZING</b> <input type="checkbox"/> Interior Glazing	<b>FLOORING TYPES</b> Material: <input type="text" value="PFC"/> Base: <input type="text" value="FCB"/>	<b>ROOM ACCESSORIES</b> <input type="checkbox"/> Coat Hooks <input type="checkbox"/> Ceiling Lift <input checked="" type="checkbox"/> Magnetic Whiteboard <input type="checkbox"/> Mirror <input type="checkbox"/> Infant Change Table <input type="checkbox"/> Privacy Curtain
--	---	---	--	---

- LEGEND:**
- WALL AND CEILING LEGEND:**
- AC Architectural Ceiling
  - ACT Acoustic Ceiling Tile
  - ACT-C Cleanroom
  - ARGB Abuse-Resistant Gypsum Board
  - GB Gypsum Board
  - IRGB Impact-Resistant Gypsum Board
  - KLCT Kitchen Lay-in Ceiling Tile
  - MMRGB Moisture and Mould-Resistant Gypsum Board
  - SACT Security Acoustic Ceiling Tile
- WALL FINISHES LEGEND:**
- EWC Epoxy Wall Coating
  - HPC High Performance Coating
  - PT Paint
- CEILING FINISHES LEGEND:**
- ECC Epoxy Ceiling Coating
  - HPC High Performance Coating
  - PF Prefinished
  - PT Paint
- WALL PROTECTION LEGEND:**
- ESRP Extruded Semi-Rigid PVCu Panel
  - FRL Fibre Reinforced Laminate
  - FRP Fibreglass Reinforced Plastic
  - PVV Protective Vinyl Wallcovering
  - RHIS Rigid High Impact Sheet
  - WSSP Wetwall Solid Surface Panel
  - WVV Wetroom Vinyl Wallcovering
- FLOOR FINISHES LEGEND:**
- CFS Concrete Floor Sealer
  - EFC Epoxy Floor Coating
  - PFC Polyurethane Floor Coating
  - RAF Rubber Athletic Flooring
  - RSF Rubber Sheet Flooring
  - SCF Seamless Cushioned Flooring
  - SDRF Static-Dissipative Rubber Sheet Flooring
  - SDVF Static-Dissipative Vinyl Sheet Flooring
  - VSF Vinyl Sheet Flooring
  - WSVF Wetroom Safety Vinyl Sheet Flooring
- FLOOR BASE LEGEND:**
- FCB Flash Cove Base
  - RB Rubber Base
  - SCF Seamless Cushioned Flooring

**DOORS**

Types:

Type	Qty	Size (mm)	Material	Finish	Side Lt.	Blinds	Protect.	Privacy Film	Function	Card Reader	Mag Lock	Auto Opener	Hold Open	Hinges	Accessory 1	Accessory 2	Accessory 3	Closer
B	1	915 x 2135	Hollow Metal	Paint	<input type="checkbox"/>	<input type="checkbox"/>		<input type="checkbox"/>	Storeroom	<input checked="" type="checkbox"/>	<input type="checkbox"/>	<input type="checkbox"/>	<input type="checkbox"/>	Butt Hinge				Surface

Door Remarks:  Security Grille  Anti-barricade strategy

**MILLWORK AND SPECIALTY CASEWORK**

**UPPER UNITS** U1 U2 U3 U4 U5 U6 U7 U8

**LOWER UNITS** L1 L2 L3 L4 L5 L6 L7 L8 L9 L10 L11 L12

**RECEPTION/TRANSACTION COUNTER / CARE TEAM STATION DESK** TC1 TC2

**UTILITY SINK AND COUNTER UNIT** UC1

**Storage Requirements:**

**FINISHES**

Full-height Cabinet:

Upper Millwork:

Countertop:

Lower Millwork:

Shelf:

Remarks:

Category	Min. Length (mm)	Motorized Adjustable Height	Standing Height	Specialty Casework
2	1200	<input type="checkbox"/>	<input checked="" type="checkbox"/>	<input type="checkbox"/>

## MECHANICAL REQUIREMENTS

<b>PLUMBING</b> (Quantity) Hand Hygiene Sink: <input type="text" value="1"/> Lavatory: <input type="text"/> Kitchen Sink: <input type="text"/> Seamless Kitchen Sink: <input type="text"/> Utility / Process Sink: <input type="text"/> Scrub Sink: <input type="text"/> Floor Sink: <input type="text"/> Plumbing Remarks: <input type="text"/>	Other Fixtures: <input type="checkbox"/> Shower <input type="checkbox"/> Tub <input type="checkbox"/> Ice Maker <input type="checkbox"/> Water Closet <input type="checkbox"/> Instantaneous Hot Water <input type="checkbox"/> Eyewash Station <input type="checkbox"/> Eyewash/Shower Station <input type="checkbox"/> Emergency Shower <input type="checkbox"/> Flush Rim Sink <input type="checkbox"/> Floor Drain <input type="checkbox"/> Water Bottle Refill Station Other: <input type="text"/>	<b>MED / NON-MED GASES</b> (Quantity) Oxygen: <input type="text"/> Medical Air: <input type="text"/> Medical Vacuum: <input type="text"/> Nitrous Oxide: <input type="text"/> CO2: <input type="text"/> AGSS: <input type="text"/> Nitrogen: <input type="text"/> Laboratory Air: <input type="text"/> Laboratory Vacuum: <input type="text"/> Utility Compressed Air: <input type="text"/> Gas Remarks: <input type="text"/>
--	--	---



# Appendix 1B Minimum Room Requirements

Room Name:

Program Number(s):

1.	X2.04	7.		13.		19.		25.		31.		37.		43.
2.		8.		14.		20.		26.		32.		38.		44.
3.		9.		15.		21.		27.		33.		39.		45.
4.		10.		16.		22.		28.		34.		40.		46.
5.		11.		17.		23.		29.		35.		41.		47.
6.		12.		18.		24.		30.		36.		42.		48.

## ARCHITECTURAL REQUIREMENTS

<b>WALL AND CEILING</b> Wall Material: <input type="text" value="MMRGB"/> Finish: <input type="text" value="HPC"/> Ceiling Material: <input type="text" value="KLCT"/> Finish: <input type="text" value="PF"/>	<b>WALL PROTECTION</b> Type: <input type="text" value="FRP"/> <input checked="" type="checkbox"/> Corner Guards <input type="checkbox"/> Hand Rails <input type="checkbox"/> Bed Bumper / Locator Height: <input type="text" value="2185 mm"/> <input type="checkbox"/> Crash Rails <input type="checkbox"/> Chair Rail	<b>GLAZING</b> <input type="checkbox"/> Interior Glazing	<b>FLOORING TYPES</b> Material: <input type="text" value="PFC"/> Base: <input type="text" value="FCB"/>	<b>ROOM ACCESSORIES</b> <input checked="" type="checkbox"/> Coat Hooks <input type="checkbox"/> Ceiling Lift <input type="checkbox"/> Magnetic Whiteboard <input type="checkbox"/> Mirror <input type="checkbox"/> Infant Change Table <input type="checkbox"/> Privacy Curtain
--	---	---	--	---

- LEGEND:**
- WALL AND CEILING LEGEND:**
- AC Architectural Ceiling
  - ACT Acoustic Ceiling Tile
  - ACT-C Cleanroom
  - ARGB Abuse-Resistant Gypsum Board
  - GB Gypsum Board
  - IRGB Impact-Resistant Gypsum Board
  - KLCT Kitchen Lay-in Ceiling Tile
  - MMRGB Moisture and Mould-Resistant Gypsum Board
  - SACT Security Acoustic Ceiling Tile
- WALL FINISHES LEGEND:**
- EWC Epoxy Wall Coating
  - HPC High Performance Coating
  - PT Paint
- CEILING FINISHES LEGEND:**
- ECC Epoxy Ceiling Coating
  - HPC High Performance Coating
  - PF Prefinished
  - PT Paint
- WALL PROTECTION LEGEND:**
- ESRP Extruded Semi-Rigid PVCu Panel
  - FRL Fibre Reinforced Laminate
  - FRP Fibreglass Reinforced Plastic
  - PVV Protective Vinyl Wallcovering
  - RHIS Rigid High Impact Sheet
  - WSSP Wetwall Solid Surface Panel
  - WVV Wetroom Vinyl Wallcovering
- FLOOR FINISHES LEGEND:**
- CFS Concrete Floor Sealer
  - EFC Epoxy Floor Coating
  - PFC Polyurethane Floor Coating
  - RAF Rubber Athletic Flooring
  - RSF Rubber Sheet Flooring
  - SCF Seamless Cushioned Flooring
  - SDRF Static-Dissipative Rubber Sheet Flooring
  - SDVF Static-Dissipative Vinyl Sheet Flooring
  - VSF Vinyl Sheet Flooring
  - WSVF Wetroom Safety Vinyl Sheet Flooring
- FLOOR BASE LEGEND:**
- FCB Flash Cove Base
  - RB Rubber Base
  - SCF Seamless Cushioned Flooring

**DOORS**

Types:

Type:Qty:	Size (mm):	Material:	Finish:	Side Lt:	Blinds:	Protect.:	Privacy Film:	Function:	Card Reader:	Mag Lock:	Auto Opener:	Hold Open:	Hinges:	Accessory 1:	Accessory 2:	Accessory 3:	Closer:	

Door Remarks: Refer to Appendix 3I [Food Services Equipment List]

- Security Grille
- Anti-barricade strategy

**MILLWORK AND SPECIALTY CASEWORK**

**UPPER UNITS** (U1-U8) **LOWER UNITS** (L1-L9)

**RECEPTION/TRANSACTION COUNTER / CARE TEAM STATION DESK** (TC1, TC2)

**UTILITY SINK AND COUNTER UNIT** (UC1)

**Storage Requirements:**

**FINISHES**

Full-height Cabinet:

Upper Millwork:

Countertop:

Lower Millwork:

Shelf:

Remarks: Room constructed of pre-fabricated walk in panels (ceiling, walls and floor) complete with pre-fabricated walk in door assembly, wall protection, corner guards and enclosure panels. Room complete with floor depression consisting of sand leveling, 4" pre-fabricated floor panel, poured slab and floor finish.

Category	Min. Length (mm)	Motorized Adjustable Height	Standing Height	Specialty Casework
Category 0 - None				
Category 1 - Low (1% - 4%)				
Category 2 - Med (5% - 9%)				
Category 3 - High (10% or Greater)				

## MECHANICAL REQUIREMENTS

<b>PLUMBING</b> (Quantity) Hygiene Sink: <input type="text"/> Lavatory: <input type="text"/> Kitchen Sink: <input type="text"/> Seamless Kitchen Sink: <input type="text"/> Utility / Process Sink: <input type="text"/> Scrub Sink: <input type="text"/> Floor Sink: <input type="text"/> Plumbing Remarks: Provide indirect drain to funnel floor drain located outside of the walk in. Placement not to impede door, path of travel and cart movement.	<b>Other Fixtures:</b> <input type="checkbox"/> Shower <input type="checkbox"/> Tub <input type="checkbox"/> Ice Maker <input type="checkbox"/> Water Closet <input type="checkbox"/> Instantaneous Hot Water <input type="checkbox"/> Eyewash Station <input type="checkbox"/> Eyewash/Shower Station <input type="checkbox"/> Emergency Shower <input type="checkbox"/> Flush Rim Sink <input checked="" type="checkbox"/> Floor Drain <input type="checkbox"/> Water Bottle Refill Station Other: <input type="text"/>	<b>MED / NON-MED GASES</b> (Quantity) Oxygen: <input type="text"/> Medical Air: <input type="text"/> Medical Vacuum: <input type="text"/> Nitrous Oxide: <input type="text"/> CO2: <input type="text"/> AGSS: <input type="text"/> Nitrogen: <input type="text"/> Laboratory Air: <input type="text"/> Laboratory Vacuum: <input type="text"/> Utility Compressed Air: <input type="text"/> Gas Remarks: <input type="text"/>
---	--	---

**Appendix 1B Minimum Room Requirements**

Room Name:

Program Number(s):

1.	X2.03	7.		13.		19.		25.		31.		37.		43.
2.		8.		14.		20.		26.		32.		38.		44.
3.		9.		15.		21.		27.		33.		39.		45.
4.		10.		16.		22.		28.		34.		40.		46.
5.		11.		17.		23.		29.		35.		41.		47.
6.		12.		18.		24.		30.		36.		42.		48.

**ARCHITECTURAL REQUIREMENTS**

<b>WALL AND CEILING</b> Wall Material: <input type="text" value="MMRGB"/> Finish: <input type="text" value="HPC"/> Ceiling Material: <input type="text" value="KLCT"/> Finish: <input type="text" value="PF"/>		<b>WALL PROTECTION</b> Type: <input type="text" value="FRP"/> <input checked="" type="checkbox"/> Corner Guards <input type="checkbox"/> Hand Rails <input type="checkbox"/> Bed Bumper / Locator Height: <input type="text" value="2185 mm"/> <input type="checkbox"/> Crash Rails <input type="checkbox"/> Chair Rail			<b>GLAZING</b> <input type="checkbox"/> Interior Glazing		<b>FLOORING TYPES</b> Material: <input type="text" value="PFC"/> Base: <input type="text" value="FCB"/>		<b>ROOM ACCESSORIES</b> <input checked="" type="checkbox"/> Coat Hooks <input type="checkbox"/> Ceiling Lift <input type="checkbox"/> Magnetic Whiteboard <input type="checkbox"/> Mirror <input type="checkbox"/> Infant Change Table <input type="checkbox"/> Privacy Curtain		
--	--	---	--	--	---	--	--	--	---	--	--

- LEGEND:**
- WALL AND CEILING LEGEND:**
- AC Architectural Ceiling
  - ACT Acoustic Ceiling Tile
  - ACT-C Cleanroom
  - ARGB Abuse-Resistant Gypsum Board
  - GB Gypsum Board
  - IRGB Impact-Resistant Gypsum Board
  - KLCT Kitchen Lay-in Ceiling Tile
  - MMRGB Moisture and Mould-Resistant Gypsum Board
  - SACT Security Acoustic Ceiling Tile
- WALL FINISHES LEGEND:**
- EWC Epoxy Wall Coating
  - HPC High Performance Coating
  - PT Paint
- CEILING FINISHES LEGEND:**
- ECC Epoxy Ceiling Coating
  - HPC High Performance Coating
  - PF Prefinished
  - PT Paint
- WALL PROTECTION LEGEND:**
- ESRP Extruded Semi-Rigid PVCu Panel
  - FRL Fibre Reinforced Laminate
  - FRP Fibreglass Reinforced Plastic
  - PVV Protective Vinyl Wallcovering
  - RHIS Rigid High Impact Sheet
  - WSSP Wetwall Solid Surface Panel
  - WVV Wetroom Vinyl Wallcovering
- FLOOR FINISHES LEGEND:**
- CFS Concrete Floor Sealer
  - EFC Epoxy Floor Coating
  - PFC Polyurethane Floor Coating
  - RAF Rubber Athletic Flooring
  - RSF Rubber Sheet Flooring
  - SCF Seamless Cushioned Flooring
  - SDRF Static-Dissipative Rubber Sheet Flooring
  - SDVF Static-Dissipative Vinyl Sheet Flooring
  - VSF Vinyl Sheet Flooring
  - WSVF Wetroom Safety Vinyl Sheet Flooring
- FLOOR BASE LEGEND:**
- FCB Flash Cove Base
  - RB Rubber Base
  - SCF Seamless Cushioned Flooring

**DOORS**

Types:

Type:Qty:	Size (mm):	Material:	Finish:	Side Lt:	Blinds:	Protect.:	Privacy Film:	Function:	Card Reader:	Mag Lock:	Auto Opener:	Hold Open:	Hinges:	Accessory 1:	Accessory 2:	Accessory 3:	Closer:	

Door Remarks: Refer to Appendix 3I [Food Services Equipment List]

- Security Grille
- Anti-barricade strategy

**MILLWORK AND SPECIALTY CASEWORK**

Storage Requirements:

**UPPER UNITS** (U1-U8)

**LOWER UNITS** (L1-L12)

**RECEPTION/TRANSACTION COUNTER / CARE TEAM STATION DESK** (TC1, TC2)

**UTILITY SINK AND COUNTER UNIT** (UC1)

**SHELF** (S1)

**FULL-HEIGHT CABINETS** (C1-C5)

**Legend:**

Category	Min. Length (mm)	Motorized Adjustable Height	Standing Height	Specialty Casework
Category 0 - None				
Category 1 - Low (1% - 4%)				
Category 2 - Med (5% - 9%)				
Category 3 - High (10% or Greater)				

**FINISHES**

Full-height Cabinet:

Upper Millwork:

Countertop:

Lower Millwork:

Shelf:

Remarks: Room constructed of pre-fabricated walk in panels (ceiling, walls and floor) complete with pre-fabricated walk in door assembly, wall protection, corner guards and enclosure panels. Room complete with floor depression consisting of sand leveling, 4" pre-fabricated floor panel, poured slab and floor finish.

**MECHANICAL REQUIREMENTS**

**PLUMBING**

Hand Hygiene Sink:	Laundry:	Kitchen Sink:	Seamless Kitchen Sink:	Utility / Process Sink:	Scrub Sink:	Floor Sink:

Plumbing Remarks: Provide indirect drain to funnel floor drain located outside of the walk in. Placement not to impede door, path of travel and cart movement.

**Other Fixtures:**

- Shower
- Tub
- Ice Maker
- Water Closet
- Instantaneous Hot Water
- Eyewash Station
- Eyewash/Shower Station
- Emergency Shower
- Flush Rim Sink
- Floor Drain
- Water Bottle Refill Station

Other:

**MED / NON-MED GASES**

Oxygen:	Medical Air:	Medical Vacuum:	Nitrous Oxide:	CO2:	AGSS:	Nitrogen:	Laboratory Air:	Laboratory Vacuum:	Utility Compressed Air:

Gas Remarks:

**Appendix 1B Minimum Room Requirements**

Room Name:

Program Number(s):

1. X2.01.01	7.	13.	19.	25.	31.	37.	43.
2.	8.	14.	20.	26.	32.	38.	44.
3.	9.	15.	21.	27.	33.	39.	45.
4.	10.	16.	22.	28.	34.	40.	46.
5.	11.	17.	23.	29.	35.	41.	47.
6.	12.	18.	24.	30.	36.	42.	48.

**ARCHITECTURAL REQUIREMENTS**

<b>WALL AND CEILING</b> Wall Material: <input type="text" value="MMRGB"/> Finish: <input type="text" value="HPC"/> Ceiling Material: <input type="text" value="KLCT"/> Finish: <input type="text" value="PF"/>	<b>WALL PROTECTION</b> Type: <input type="text" value="FRP"/> <input checked="" type="checkbox"/> Corner Guards <input type="checkbox"/> Hand Rails <input type="checkbox"/> Bed Bumper / Locator Height: <input type="text" value="2185 mm"/> <input checked="" type="checkbox"/> Crash Rails <input type="checkbox"/> Chair Rail	<b>GLAZING</b> <input type="checkbox"/> Interior Glazing	<b>FLOORING TYPES</b> Material: <input type="text" value="PFC"/> Base: <input type="text" value="FCB"/>	<b>ROOM ACCESSORIES</b> <input type="checkbox"/> Coat Hooks <input type="checkbox"/> Ceiling Lift <input checked="" type="checkbox"/> Magnetic Whiteboard <input type="checkbox"/> Mirror <input type="checkbox"/> Infant Change Table <input type="checkbox"/> Privacy Curtain
--	--	---	--	---

- LEGEND:**
- WALL AND CEILING LEGEND:**
- AC Architectural Ceiling
  - ACT Acoustic Ceiling Tile
  - ACT-C Cleanroom
  - ARGB Abuse-Resistant Gypsum Board
  - GB Gypsum Board
  - IRGB Impact-Resistant Gypsum Board
  - KLCT Kitchen Lay-in Ceiling Tile
  - MMRGB Moisture and Mould-Resistant Gypsum Board
  - SACT Security Acoustic Ceiling Tile
- WALL FINISHES LEGEND:**
- EWC Epoxy Wall Coating
  - HPC High Performance Coating
  - PT Paint
- CEILING FINISHES LEGEND:**
- ECC Epoxy Ceiling Coating
  - HPC High Performance Coating
  - PF Prefinished
  - PT Paint
- WALL PROTECTION LEGEND:**
- ESRP Extruded Semi-Rigid PVCu Panel
  - FRL Fibre Reinforced Laminate
  - FRP Fibreglass Reinforced Plastic
  - PVV Protective Vinyl Wallcovering
  - RHIS Rigid High Impact Sheet
  - WSSP Wetwall Solid Surface Panel
  - WVV Wetroom Vinyl Wallcovering
- FLOOR FINISHES LEGEND:**
- CFS Concrete Floor Sealer
  - EFC Epoxy Floor Coating
  - PFC Polyurethane Floor Coating
  - RAF Rubber Athletic Flooring
  - RSF Rubber Sheet Flooring
  - SCF Seamless Cushioned Flooring
  - SDRF Static-Dissipative Rubber Sheet Flooring
  - SDVF Static-Dissipative Vinyl Sheet Flooring
  - VSF Vinyl Sheet Flooring
  - WSVF Wetroom Safety Vinyl Sheet Flooring
- FLOOR BASE LEGEND:**
- FCB Flash Cove Base
  - RB Rubber Base
  - SCF Seamless Cushioned Flooring

**DOORS**

Types:

Type	Qty	Size (mm)	Material	Finish	Side Lt.	Blinds	Protect.	Privacy Film	Function	Card Reader	Mag Lock	Auto Opener	Hold Open	Hinges	Accessory 1	Accessory 2	Accessory 3	Closer
B2	1	1830 x 2135	Solid Core	FRL	<input type="checkbox"/>	<input type="checkbox"/>	2 High	<input type="checkbox"/>	Push/Pull	<input checked="" type="checkbox"/>	<input type="checkbox"/>	<input checked="" type="checkbox"/>	<input type="checkbox"/>	Butt Hinge	Elec. Strike			Concealed

Door Remarks:  Security Grille  Anti-barricade strategy

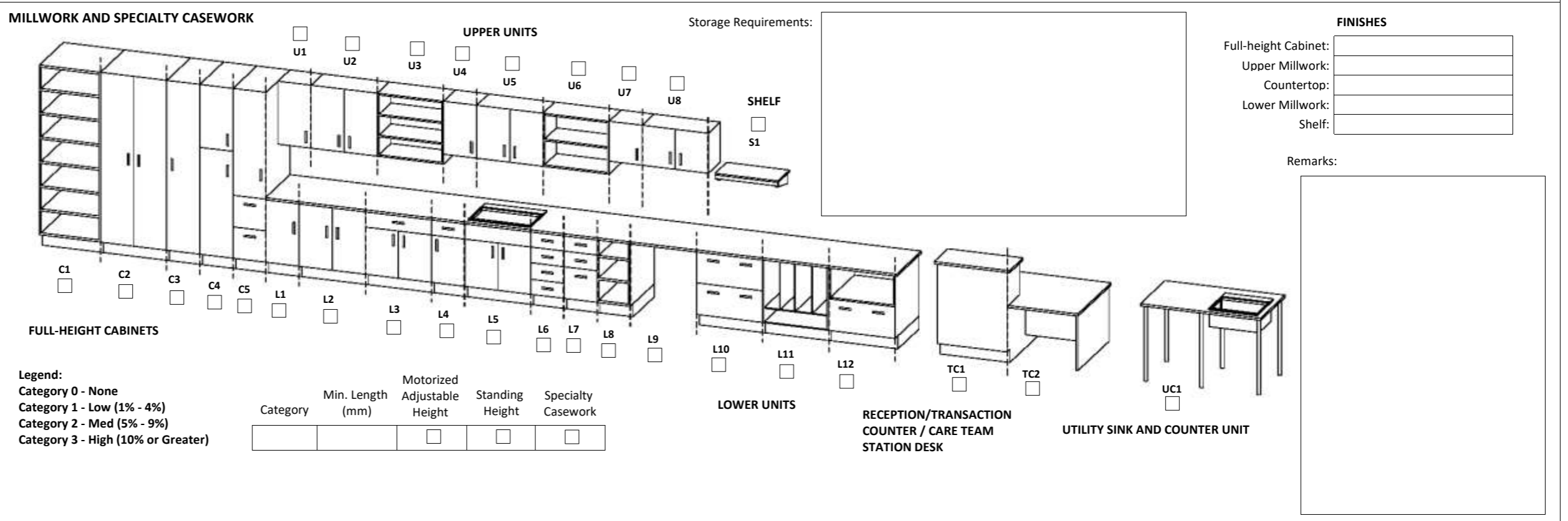

**MECHANICAL REQUIREMENTS**

<b>PLUMBING</b> (Quantity) Hand Hygiene Sink: <input type="text" value="1"/> Lavatory: <input type="text"/> Kitchen Sink: <input type="text"/> Seamless Kitchen Sink: <input type="text"/> Utility / Process Sink: <input type="text"/> Scrub Sink: <input type="text"/> Floor Sink: <input type="text"/> Plumbing Remarks: <input type="text" value="To accommodate equipment as noted in Appendix 1I Food Service Equipment Specifications."/>	Other Fixtures: <input type="checkbox"/> Shower <input type="checkbox"/> Tub <input type="checkbox"/> Ice Maker <input type="checkbox"/> Water Closet <input type="checkbox"/> Instantaneous Hot Water <input type="checkbox"/> Eyewash Station <input type="checkbox"/> Eyewash/Shower Station <input type="checkbox"/> Emergency Shower <input type="checkbox"/> Flush Rim Sink <input checked="" type="checkbox"/> Floor Drain <input type="checkbox"/> Water Bottle Refill Station Other: <input type="text"/>	<b>MED / NON-MED GASES</b> (Quantity) Oxygen: <input type="text"/> Medical Air: <input type="text"/> Medical Vacuum: <input type="text"/> Nitrous Oxide: <input type="text"/> CO2: <input type="text"/> AGSS: <input type="text"/> Nitrogen: <input type="text"/> Laboratory Air: <input type="text"/> Laboratory Vacuum: <input type="text"/> Utility Compressed Air: <input type="text"/> Gas Remarks: <input type="text"/>
--	---	---



**Appendix 1B Minimum Room Requirements**

Room Name:

Program Number(s):

1. X2.01.07	7.	13.	19.	25.	31.	37.	43.
2.	8.	14.	20.	26.	32.	38.	44.
3.	9.	15.	21.	27.	33.	39.	45.
4.	10.	16.	22.	28.	34.	40.	46.
5.	11.	17.	23.	29.	35.	41.	47.
6.	12.	18.	24.	30.	36.	42.	48.

**ARCHITECTURAL REQUIREMENTS**

<b>WALL AND CEILING</b> Wall Material: <input type="text" value="MMRGB"/> Finish: <input type="text" value="HPC"/> Ceiling Material: <input type="text" value="KLCT"/> Finish: <input type="text" value="PF"/>	<b>WALL PROTECTION</b> Type: <input type="text" value="FRP"/> <input checked="" type="checkbox"/> Corner Guards <input type="checkbox"/> Hand Rails <input type="checkbox"/> Bed Bumper / Locator Height: <input type="text" value="2185 mm"/> <input type="checkbox"/> Crash Rails <input type="checkbox"/> Chair Rail	<b>GLAZING</b> <input type="checkbox"/> Interior Glazing	<b>FLOORING TYPES</b> Material: <input type="text" value="PFC"/> Base: <input type="text" value="FCB"/>	<b>ROOM ACCESSORIES</b> <input type="checkbox"/> Coat Hooks <input type="checkbox"/> Ceiling Lift <input type="checkbox"/> Magnetic Whiteboard <input type="checkbox"/> Mirror <input type="checkbox"/> Infant Change Table <input type="checkbox"/> Privacy Curtain
--	---	---	--	--

- LEGEND:**
- WALL AND CEILING LEGEND:**
- AC Architectural Ceiling
  - ACT Acoustic Ceiling Tile
  - ACT-C Cleanroom
  - ARGB Abuse-Resistant Gypsum Board
  - GB Gypsum Board
  - IRGB Impact-Resistant Gypsum Board
  - KLCT Kitchen Lay-in Ceiling Tile
  - MMRGB Moisture and Mould-Resistant Gypsum Board
  - SACT Security Acoustic Ceiling Tile
- WALL FINISHES LEGEND:**
- EWC Epoxy Wall Coating
  - HPC High Performance Coating
  - PT Paint
- CEILING FINISHES LEGEND:**
- ECC Epoxy Ceiling Coating
  - HPC High Performance Coating
  - PF Prefinished
  - PT Paint
- WALL PROTECTION LEGEND:**
- ESRP Extruded Semi-Rigid PVCu Panel
  - FRL Fibre Reinforced Laminate
  - FRP Fibreglass Reinforced Plastic
  - PVV Protective Vinyl Wallcovering
  - RHIS Rigid High Impact Sheet
  - WSSP Wetwall Solid Surface Panel
  - WVV Wetroom Vinyl Wallcovering
- FLOOR FINISHES LEGEND:**
- CFS Concrete Floor Sealer
  - EFC Epoxy Floor Coating
  - PFC Polyurethane Floor Coating
  - RAF Rubber Athletic Flooring
  - RSF Rubber Sheet Flooring
  - SCF Seamless Cushioned Flooring
  - SDRF Static-Dissipative Rubber Sheet Flooring
  - SDVF Static-Dissipative Vinyl Sheet Flooring
  - VSF Vinyl Sheet Flooring
  - WSVF Wetroom Safety Vinyl Sheet Flooring
- FLOOR BASE LEGEND:**
- FCB Flash Cove Base
  - RB Rubber Base
  - SCF Seamless Cushioned Flooring

**DOORS**

Types:

Type	Qty	Size (mm)	Material	Finish	Side Lt	Blinds	Protect	Privacy Film	Function	Card Reader	Mag Lock	Auto Opener	Hold Open	Hinges	Accessory 1	Accessory 2	Accessory 3	Closer

Door Remarks:  Security Grille  Anti-barricade strategy

**MILLWORK AND SPECIALTY CASEWORK**

Storage Requirements:

**UPPER UNITS** (U1-U8) **SHELF** (S1)

**LOWER UNITS** (L1-L12) **RECEPTION/TRANSACTION COUNTER / CARE TEAM STATION DESK** (TC1, TC2) **UTILITY SINK AND COUNTER UNIT** (UC1)

**FULL-HEIGHT CABINETS** (C1-C5)

**Legend:**

Category	Min. Length (mm)	Motorized Adjustable Height	Standing Height	Specialty Casework
Category 0 - None				
Category 1 - Low (1% - 4%)				
Category 2 - Med (5% - 9%)				
Category 3 - High (10% or Greater)				

**FINISHES**

Full-height Cabinet:   
 Upper Millwork:   
 Countertop:   
 Lower Millwork:   
 Shelf:

Remarks:

**MECHANICAL REQUIREMENTS**

**PLUMBING** (Quantity)

Hand Hygiene Sink:	Lavatory:	Kitchen Sink:	Seamless Kitchen Sink:	Utility / Process Sink:	Scrub Sink:	Floor Sink:

Plumbing Remarks:

**Other Fixtures:**

- Shower
- Tub
- Ice Maker
- Water Closet
- Instantaneous Hot Water
- Eyewash Station
- Eyewash/Shower Station
- Emergency Shower
- Flush Rim Sink
- Floor Drain
- Water Bottle Refill Station

Other:

**MED / NON-MED GASES** (Quantity)

Oxygen:	Medical Air:	Medical Vacuum:	Nitrous Oxide:	CO2:	AGSS:	Nitrogen:	Laboratory Air:	Laboratory Vacuum:	Utility Compressed Air:

Gas Remarks:

**Appendix 1B Minimum Room Requirements**

Room Name:

Program Number(s):

1.	X3.01	7.		13.		19.		25.		31.		37.		43.
2.		8.		14.		20.		26.		32.		38.		44.
3.		9.		15.		21.		27.		33.		39.		45.
4.		10.		16.		22.		28.		34.		40.		46.
5.		11.		17.		23.		29.		35.		41.		47.
6.		12.		18.		24.		30.		36.		42.		48.

**ARCHITECTURAL REQUIREMENTS**

<b>WALL AND CEILING</b> Wall Material: <input type="text" value="MMRGB"/> Finish: <input type="text" value="HPC"/> Ceiling Material: <input type="text" value="KLCT"/> Finish: <input type="text" value="PF"/>		<b>WALL PROTECTION</b> Type: <input type="text" value="FRP"/> <input checked="" type="checkbox"/> Corner Guards <input type="checkbox"/> Hand Rails <input type="checkbox"/> Bed Bumper / Locator Height: <input type="text" value="2185 mm"/> <input checked="" type="checkbox"/> Crash Rails <input type="checkbox"/> Chair Rail		<b>GLAZING</b> <input type="checkbox"/> Interior Glazing		<b>FLOORING TYPES</b> Material: <input type="text" value="PFC"/> Base: <input type="text" value="FCB"/>		<b>ROOM ACCESSORIES</b> <input type="checkbox"/> Coat Hooks <input type="checkbox"/> Ceiling Lift <input type="checkbox"/> Magnetic Whiteboard <input type="checkbox"/> Mirror <input type="checkbox"/> Infant Change Table <input type="checkbox"/> Privacy Curtain	
--	--	--	--	---	--	--	--	--	--

- LEGEND:**
- WALL AND CEILING LEGEND:**
- AC Architectural Ceiling
  - ACT Acoustic Ceiling Tile
  - ACT-C Cleanroom
  - ARGB Abuse-Resistant Gypsum Board
  - GB Gypsum Board
  - IRGB Impact-Resistant Gypsum Board
  - KLCT Kitchen Lay-in Ceiling Tile
  - MMRGB Moisture and Mould-Resistant Gypsum Board
  - SACT Security Acoustic Ceiling Tile
- WALL FINISHES LEGEND:**
- EWC Epoxy Wall Coating
  - HPC High Performance Coating
  - PT Paint
- CEILING FINISHES LEGEND:**
- ECC Epoxy Ceiling Coating
  - HPC High Performance Coating
  - PF Prefinished
  - PT Paint
- WALL PROTECTION LEGEND:**
- ESRP Extruded Semi-Rigid PVCu Panel
  - FRL Fibre Reinforced Laminate
  - FRP Fibreglass Reinforced Plastic
  - PVV Protective Vinyl Wallcovering
  - RHIS Rigid High Impact Sheet
  - WSSP Wetwall Solid Surface Panel
  - WVV Wetroom Vinyl Wallcovering
- FLOOR FINISHES LEGEND:**
- CFS Concrete Floor Sealer
  - EFC Epoxy Floor Coating
  - PFC Polyurethane Floor Coating
  - RAF Rubber Athletic Flooring
  - RSF Rubber Sheet Flooring
  - SCF Seamless Cushioned Flooring
  - SDRF Static-Dissipative Rubber Sheet Flooring
  - SDVF Static-Dissipative Vinyl Sheet Flooring
  - VSF Vinyl Sheet Flooring
  - WSVF Wetroom Safety Vinyl Sheet Flooring
- FLOOR BASE LEGEND:**
- FCB Flash Cove Base
  - RB Rubber Base
  - SCF Seamless Cushioned Flooring

**DOORS**

Types:

Type	Qty	Size (mm)	Material	Finish	Side Lt.	Blinds	Protect.	Privacy Film	Function	Card Reader	Mag Lock	Auto Opener	Hold Open	Hinges	Accessory 1	Accessory 2	Accessory 3	Closer

Door Remarks:  Security Grille  Anti-barricade strategy



**MECHANICAL REQUIREMENTS**

<b>PLUMBING</b> (Quantity) Hygiene Sink: <input type="text" value="1"/> Lavatory: <input type="text"/> Kitchen Sink: <input type="text"/> Kitchen Sink: <input type="text"/> Process Sink: <input type="text"/> Scrub Sink: <input type="text"/> Floor Sink: <input type="text"/>		Other Fixtures: <input type="checkbox"/> Shower <input type="checkbox"/> Tub <input type="checkbox"/> Ice Maker <input type="checkbox"/> Water Closet <input type="checkbox"/> Instantaneous Hot Water		<input type="checkbox"/> Eyewash Station <input type="checkbox"/> Eyewash/Shower Station <input type="checkbox"/> Emergency Shower <input type="checkbox"/> Flush Rim Sink <input checked="" type="checkbox"/> Floor Drain <input type="checkbox"/> Water Bottle Refill Station		<b>MED / NON-MED GASES</b> (Quantity) Oxygen: <input type="text"/> Medical Air: <input type="text"/> Medical Vacuum: <input type="text"/> Nitrous Oxide: <input type="text"/> CO2: <input type="text"/> AGSS: <input type="text"/> Nitrogen: <input type="text"/> Laboratory Air: <input type="text"/> Laboratory Vacuum: <input type="text"/> Utility Compressed Air: <input type="text"/>	
Plumbing Remarks: To accommodate dishwashing equipment as noted in Appendix 1I Food Service Equipment Specifications. Trench Drains(s) - direct drain to grease trap.		Gas Remarks: <input type="text"/>					

**Appendix 1B Minimum Room Requirements**

Room Name:

Program Number(s):

1.	X2.01.03	7.		13.		19.		25.		31.		37.		43.
2.		8.		14.		20.		26.		32.		38.		44.
3.		9.		15.		21.		27.		33.		39.		45.
4.		10.		16.		22.		28.		34.		40.		46.
5.		11.		17.		23.		29.		35.		41.		47.
6.		12.		18.		24.		30.		36.		42.		48.

**ARCHITECTURAL REQUIREMENTS**

<b>WALL AND CEILING</b> Wall Material: <input type="text" value="MMRGB"/> Finish: <input type="text" value="HPC"/> Ceiling Material: <input type="text" value="KLCT"/> Finish: <input type="text" value="PF"/>		<b>WALL PROTECTION</b> Type: <input type="text" value="FRP"/> <input checked="" type="checkbox"/> Corner Guards <input type="checkbox"/> Hand Rails <input type="checkbox"/> Bed Bumper / Locator Height: <input type="text" value="2185 mm"/> <input type="checkbox"/> Crash Rails <input type="checkbox"/> Chair Rail			<b>GLAZING</b> <input type="checkbox"/> Interior Glazing		<b>FLOORING TYPES</b> Material: <input type="text" value="PFC"/> Base: <input type="text" value="FCB"/>		<b>ROOM ACCESSORIES</b> <input type="checkbox"/> Coat Hooks <input type="checkbox"/> Ceiling Lift <input checked="" type="checkbox"/> Magnetic Whiteboard <input type="checkbox"/> Mirror <input type="checkbox"/> Infant Change Table <input type="checkbox"/> Privacy Curtain		
--	--	---	--	--	---	--	--	--	---	--	--

- LEGEND:**
- WALL AND CEILING LEGEND:**
- AC Architectural Ceiling
  - ACT Acoustic Ceiling Tile
  - ACT-C Cleanroom
  - ARGB Abuse-Resistant Gypsum Board
  - GB Gypsum Board
  - IRGB Impact-Resistant Gypsum Board
  - KLCT Kitchen Lay-in Ceiling Tile
  - MMRGB Moisture and Mould-Resistant Gypsum Board
  - SACT Security Acoustic Ceiling Tile
- WALL FINISHES LEGEND:**
- EWC Epoxy Wall Coating
  - HPC High Performance Coating
  - PT Paint
- CEILING FINISHES LEGEND:**
- ECC Epoxy Ceiling Coating
  - HPC High Performance Coating
  - PF Prefinished
  - PT Paint
- WALL PROTECTION LEGEND:**
- ESRP Extruded Semi-Rigid PVCu Panel
  - FRL Fibre Reinforced Laminate
  - FRP Fibreglass Reinforced Plastic
  - PVV Protective Vinyl Wallcovering
  - RHIS Rigid High Impact Sheet
  - WSSP Wetwall Solid Surface Panel
  - WVV Wetroom Vinyl Wallcovering
- FLOOR FINISHES LEGEND:**
- CFS Concrete Floor Sealer
  - EFC Epoxy Floor Coating
  - PFC Polyurethane Floor Coating
  - RAF Rubber Athletic Flooring
  - RSF Rubber Sheet Flooring
  - SCF Seamless Cushioned Flooring
  - SDRF Static-Dissipative Rubber Sheet Flooring
  - SDVF Static-Dissipative Vinyl Sheet Flooring
  - VSF Vinyl Sheet Flooring
  - WSVF Wetroom Safety Vinyl Sheet Flooring
- FLOOR BASE LEGEND:**
- FCB Flash Cove Base
  - RB Rubber Base
  - SCF Seamless Cushioned Flooring

**DOORS**

Types:

Type	Qty	Size (mm)	Material	Finish	Side Lt.	Blinds	Protect.	Privacy Film	Function	Card Reader	Mag Lock	Auto Opener	Hold Open	Hinges	Accessory 1	Accessory 2	Accessory 3	Closer

Door Remarks:  Security Grille  Anti-barricade strategy

**MILLWORK AND SPECIALTY CASEWORK**

**UPPER UNITS** (U1-U8) **LOWER UNITS** (L1-L12) **RECEPTION/TRANSACTION COUNTER / CARE TEAM STATION DESK** (TC1-TC2) **UTILITY SINK AND COUNTER UNIT** (UC1)

Storage Requirements:

**FINISHES**

Full-height Cabinet:   
 Upper Millwork:   
 Countertop:   
 Lower Millwork:   
 Shelf:

Remarks:

**Legend:**

Category	Min. Length (mm)	Motorized Adjustable Height	Standing Height	Specialty Casework
Category 0 - None				
Category 1 - Low (1% - 4%)				
Category 2 - Med (5% - 9%)				
Category 3 - High (10% or Greater)				

**MECHANICAL REQUIREMENTS**

<b>PLUMBING</b> (Quantity) Hygiene Sink: <input type="text" value="1"/> Lavatory: <input type="text"/> Kitchen Sink: <input type="text"/> Kitchen Sink: <input type="text"/> Utility / Process Sink: <input type="text"/> Scrub Sink: <input type="text"/> Floor Sink: <input type="text"/>							Other Fixtures: <input type="checkbox"/> Shower <input type="checkbox"/> Eyewash Station <input type="checkbox"/> Tub <input type="checkbox"/> Eyewash/Shower Station <input type="checkbox"/> Ice Maker <input type="checkbox"/> Emergency Shower <input type="checkbox"/> Water Closet <input checked="" type="checkbox"/> Floor Drain <input type="checkbox"/> Instantaneous Hot Water <input type="checkbox"/> Water Bottle Refill Station Other <input type="text"/>				<b>MED / NON-MED GASES</b> (Quantity) Oxygen: <input type="text"/> Medical Air: <input type="text"/> Medical Vacuum: <input type="text"/> Nitrous Oxide: <input type="text"/> CO2: <input type="text"/> AGSS: <input type="text"/> Nitrogen: <input type="text"/> Laboratory Air: <input type="text"/> Laboratory Vacuum: <input type="text"/> Utility Compressed Air: <input type="text"/>				
Plumbing Remarks: <input type="text" value="To accommodate stainless steel work tables with sinks as noted in Appendix 1I Food Service Equipment Specifications."/>											Gas Remarks: <input type="text"/>				



**Appendix 1B Minimum Room Requirements**

Room Name:

Program Number(s):

1. X1.01	7.	13.	19.	25.	31.	37.	43.
2.	8.	14.	20.	26.	32.	38.	44.
3.	9.	15.	21.	27.	33.	39.	45.
4.	10.	16.	22.	28.	34.	40.	46.
5.	11.	17.	23.	29.	35.	41.	47.
6.	12.	18.	24.	30.	36.	42.	48.

**ARCHITECTURAL REQUIREMENTS**

<b>WALL AND CEILING</b> Wall Material: <input type="text" value="MMRGB"/> Finish: <input type="text" value="HPC"/> Ceiling Material: <input type="text" value="KLCT"/> Finish: <input type="text" value="PF"/>	<b>WALL PROTECTION</b> Type: <input type="text" value="FRP"/> <input checked="" type="checkbox"/> Corner Guards <input type="checkbox"/> Hand Rails <input type="checkbox"/> Bed Bumper / Locator Height: <input type="text" value="2185 mm"/> <input checked="" type="checkbox"/> Crash Rails <input type="checkbox"/> Chair Rail	<b>GLAZING</b> <input type="checkbox"/> Interior Glazing	<b>FLOORING TYPES</b> Material: <input type="text" value="PFC"/> Base: <input type="text" value="FCB"/>	<b>ROOM ACCESSORIES</b> <input type="checkbox"/> Coat Hooks <input type="checkbox"/> Ceiling Lift <input checked="" type="checkbox"/> Magnetic Whiteboard <input type="checkbox"/> Mirror <input type="checkbox"/> Infant Change Table <input type="checkbox"/> Privacy Curtain
--	--	---	--	---

- LEGEND:**
- WALL AND CEILING LEGEND:**
- AC Architectural Ceiling
  - ACT Acoustic Ceiling Tile
  - ACT-C Cleanroom
  - ARGB Abuse-Resistant Gypsum Board
  - GB Gypsum Board
  - IRGB Impact-Resistant Gypsum Board
  - KLCT Kitchen Lay-in Ceiling Tile
  - MMRGB Moisture and Mould-Resistant Gypsum Board
  - SACT Security Acoustic Ceiling Tile
- WALL FINISHES LEGEND:**
- EWC Epoxy Wall Coating
  - HPC High Performance Coating
  - PT Paint
- CEILING FINISHES LEGEND:**
- ECC Epoxy Ceiling Coating
  - HPC High Performance Coating
  - PF Prefinished
  - PT Paint
- WALL PROTECTION LEGEND:**
- ESRP Extruded Semi-Rigid PVCu Panel
  - FRL Fibre Reinforced Laminate
  - FRP Fibreglass Reinforced Plastic
  - PVV Protective Vinyl Wallcovering
  - RHIS Rigid High Impact Sheet
  - WSSP Wetwall Solid Surface Panel
  - WVV Wetroom Vinyl Wallcovering
- FLOOR FINISHES LEGEND:**
- CFS Concrete Floor Sealer
  - EFC Epoxy Floor Coating
  - PFC Polyurethane Floor Coating
  - RAF Rubber Athletic Flooring
  - RSF Rubber Sheet Flooring
  - SCF Seamless Cushioned Flooring
  - SDRF Static-Dissipative Rubber Sheet Flooring
  - SDVF Static-Dissipative Vinyl Sheet Flooring
  - VSF Vinyl Sheet Flooring
  - WSVF Wetroom Safety Vinyl Sheet Flooring
- FLOOR BASE LEGEND:**
- FCB Flash Cove Base
  - RB Rubber Base
  - SCF Seamless Cushioned Flooring

**DOORS**

Types:

Type	Qty	Size (mm)	Material	Finish	Side Lt.	Blinds	Protect.	Privacy Film	Function	Card Reader	Mag Lock	Auto Opener	Hold Open	Hinges	Accessory 1	Accessory 2	Accessory 3	Closer
C2	1	1830 x 2135	Solid Core	FRL	<input type="checkbox"/>	<input type="checkbox"/>	2 High	<input type="checkbox"/>	Storeroom	<input checked="" type="checkbox"/>	<input type="checkbox"/>	<input type="checkbox"/>	<input checked="" type="checkbox"/>	Cont. Swing Clear	Astragal	Flush Bolt		Surface

Door Remarks:  Security Grille  Anti-barricade strategy

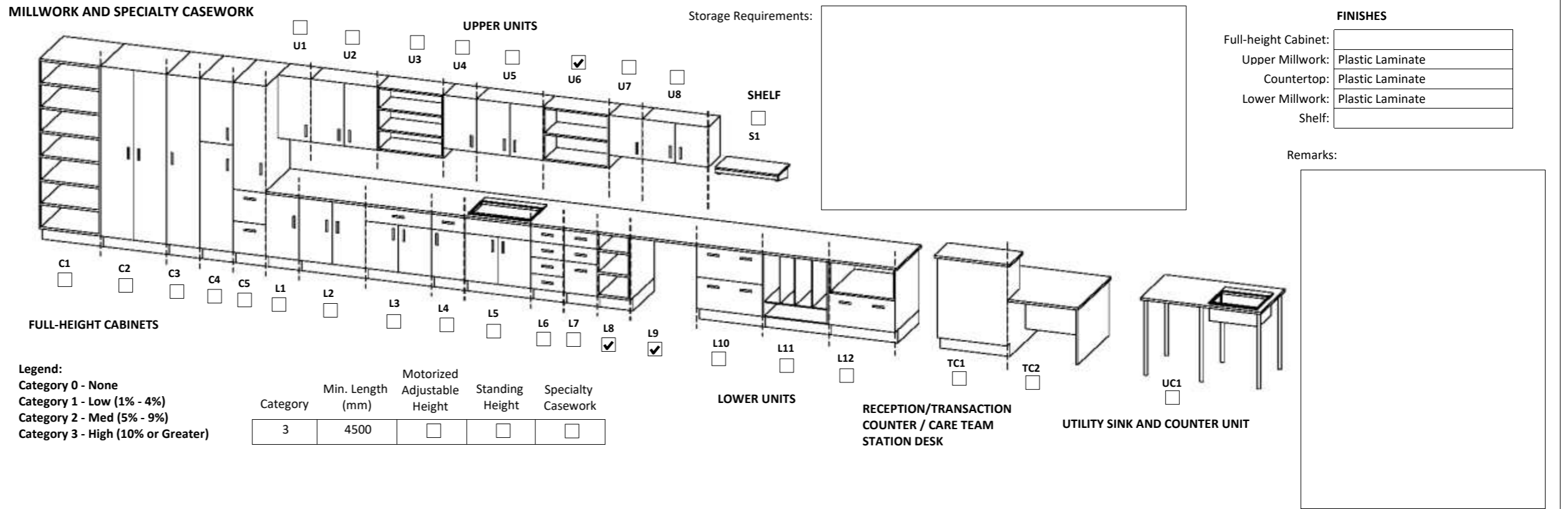

**MECHANICAL REQUIREMENTS**

<b>PLUMBING</b> (Quantity) Hand Hygiene Sink: <input type="text" value="1"/> Lavatory: <input type="text"/> Kitchen Sink: <input type="text"/> Seamless Kitchen Sink: <input type="text"/> Utility / Process Sink: <input type="text"/> Scrub Sink: <input type="text"/> Floor Sink: <input type="text"/> Plumbing Remarks: <input type="text"/>	Other Fixtures: <input type="checkbox"/> Shower <input type="checkbox"/> Tub <input type="checkbox"/> Ice Maker <input type="checkbox"/> Water Closet <input type="checkbox"/> Instantaneous Hot Water <input checked="" type="checkbox"/> Eyewash Station <input type="checkbox"/> Eyewash/Shower Station <input type="checkbox"/> Emergency Shower <input type="checkbox"/> Flush Rim Sink <input checked="" type="checkbox"/> Floor Drain <input type="checkbox"/> Water Bottle Refill Station Other: <input type="text"/>	<b>MED / NON-MED GASES</b> (Quantity) Oxygen: <input type="text"/> Medical Air: <input type="text"/> Medical Vacuum: <input type="text"/> Nitrous Oxide: <input type="text"/> CO2: <input type="text"/> AGSS: <input type="text"/> Nitrogen: <input type="text"/> Laboratory Air: <input type="text"/> Laboratory Vacuum: <input type="text"/> Utility Compressed Air: <input type="text"/> Gas Remarks: <input type="text"/>
---	---	---

**Appendix 1B Minimum Room Requirements**

Room Name:

Program Number(s):

1.	X3.02.01	7.		13.		19.		25.		31.		37.		43.
2.		8.		14.		20.		26.		32.		38.		44.
3.		9.		15.		21.		27.		33.		39.		45.
4.		10.		16.		22.		28.		34.		40.		46.
5.		11.		17.		23.		29.		35.		41.		47.
6.		12.		18.		24.		30.		36.		42.		48.

**ARCHITECTURAL REQUIREMENTS**

<b>WALL AND CEILING</b> Wall Material: <input type="text" value="ARGB 1.2m AFF, GB above"/> Finish: <input type="text" value="HPC"/> Ceiling Material: <input type="text" value="KLCT"/> Finish: <input type="text" value="PF"/>	<b>WALL PROTECTION</b> Type: <input type="text" value="FRP"/> <input checked="" type="checkbox"/> Corner Guards <input type="checkbox"/> Hand Rails <input type="checkbox"/> Bed Bumper / Locator Height: <input type="text" value="2185 mm"/> <input checked="" type="checkbox"/> Crash Rails <input type="checkbox"/> Chair Rail	<b>GLAZING</b> <input type="checkbox"/> Interior Glazing	<b>FLOORING TYPES</b> Material: <input type="text" value="PFC"/> Base: <input type="text" value="FCB"/>	<b>ROOM ACCESSORIES</b> <input type="checkbox"/> Coat Hooks <input type="checkbox"/> Ceiling Lift <input type="checkbox"/> Magnetic Whiteboard <input type="checkbox"/> Mirror <input type="checkbox"/> Infant Change Table <input type="checkbox"/> Privacy Curtain
--	--	---	--	--

- LEGEND:**
- WALL AND CEILING LEGEND:**
- AC Architectural Ceiling
  - ACT Acoustic Ceiling Tile
  - ACT-C Cleanroom
  - ARGB Abuse-Resistant Gypsum Board
  - GB Gypsum Board
  - IRGB Impact-Resistant Gypsum Board
  - KLCT Kitchen Lay-in Ceiling Tile
  - MMRGB Moisture and Mould-Resistant Gypsum Board
  - SACT Security Acoustic Ceiling Tile
- WALL FINISHES LEGEND:**
- EWC Epoxy Wall Coating
  - HPC High Performance Coating
  - PT Paint
- CEILING FINISHES LEGEND:**
- ECC Epoxy Ceiling Coating
  - HPC High Performance Coating
  - PF Prefinished
  - PT Paint
- WALL PROTECTION LEGEND:**
- ESRP Extruded Semi-Rigid PVCu Panel
  - FRL Fibre Reinforced Laminate
  - FRP Fibreglass Reinforced Plastic
  - PVV Protective Vinyl Wallcovering
  - RHIS Rigid High Impact Sheet
  - WSSP Wetwall Solid Surface Panel
  - WVV Wetroom Vinyl Wallcovering
- FLOOR FINISHES LEGEND:**
- CFS Concrete Floor Sealer
  - EFC Epoxy Floor Coating
  - PFC Polyurethane Floor Coating
  - RAF Rubber Athletic Flooring
  - RSF Rubber Sheet Flooring
  - SCF Seamless Cushioned Flooring
  - SDRF Static-Dissipative Rubber Sheet Flooring
  - SDVF Static-Dissipative Vinyl Sheet Flooring
  - VSF Vinyl Sheet Flooring
  - WSVF Wetroom Safety Vinyl Sheet Flooring
- FLOOR BASE LEGEND:**
- FCB Flash Cove Base
  - RB Rubber Base
  - SCF Seamless Cushioned Flooring

**DOORS**

Types:

Type	Qty	Size (mm)	Material	Finish	Side Lt.	Blinds	Protect.	Privacy Film	Function	Card Reader	Mag Lock	Auto Opener	Hold Open	Hinges	Accessory 1	Accessory 2	Accessory 3	Closer
C	1	1220 x 2135	Hollow Metal	Paint	<input type="checkbox"/>	<input checked="" type="checkbox"/>		<input type="checkbox"/>	Storeroom	<input checked="" type="checkbox"/>	<input type="checkbox"/>	<input checked="" type="checkbox"/>	<input type="checkbox"/>	Cont. Swing Clear	Elec. Strike			Surface

Door Remarks:  Security Grille  Anti-barricade strategy

**MILLWORK AND SPECIALTY CASEWORK**

**UPPER UNITS** (U1-U8) **LOWER UNITS** (L1-L12) **RECEPTION/TRANSACTION COUNTER / CARE TEAM STATION DESK** (TC1-TC2) **UTILITY SINK AND COUNTER UNIT** (UC1)

Storage Requirements:

**FINISHES**

Full-height Cabinet:   
 Upper Millwork:   
 Countertop:   
 Lower Millwork:   
 Shelf:

Remarks:

**Legend:**

Category	Min. Length (mm)	Motorized Adjustable Height	Standing Height	Specialty Casework
Category 0 - None		<input type="checkbox"/>	<input type="checkbox"/>	<input type="checkbox"/>
Category 1 - Low (1% - 4%)		<input type="checkbox"/>	<input type="checkbox"/>	<input type="checkbox"/>
Category 2 - Med (5% - 9%)		<input type="checkbox"/>	<input type="checkbox"/>	<input type="checkbox"/>
Category 3 - High (10% or Greater)		<input type="checkbox"/>	<input type="checkbox"/>	<input type="checkbox"/>

**MECHANICAL REQUIREMENTS**

<b>PLUMBING</b> (Quantity) Hand Hygiene Sink: <input type="text"/> Lavatory: <input type="text"/> Kitchen Sink: <input type="text"/> Seamless Kitchen Sink: <input type="text"/> Utility / Process Sink: <input type="text"/> Scrub Sink: <input type="text"/> Floor Sink: <input type="text"/> Plumbing Remarks: <input type="text"/>	Other Fixtures: <input type="checkbox"/> Shower <input type="checkbox"/> Tub <input type="checkbox"/> Ice Maker <input type="checkbox"/> Water Closet <input type="checkbox"/> Instantaneous Hot Water <input type="checkbox"/> Eyewash Station <input type="checkbox"/> Eyewash/Shower Station <input type="checkbox"/> Emergency Shower <input type="checkbox"/> Flush Rim Sink <input checked="" type="checkbox"/> Floor Drain <input type="checkbox"/> Water Bottle Refill Station Other: <input type="text"/>	<b>MED / NON-MED GASES</b> (Quantity) Oxygen: <input type="text"/> Medical Air: <input type="text"/> Medical Vacuum: <input type="text"/> Nitrous Oxide: <input type="text"/> CO2: <input type="text"/> AGSS: <input type="text"/> Nitrogen: <input type="text"/> Laboratory Air: <input type="text"/> Laboratory Vacuum: <input type="text"/> Utility Compressed Air: <input type="text"/> Gas Remarks: <input type="text"/>
---	---	---

**Appendix 1B Minimum Room Requirements**

Room Name:

Program Number(s):

1. X1.03	7.	13.	19.	25.	31.	37.	43.
2.	8.	14.	20.	26.	32.	38.	44.
3.	9.	15.	21.	27.	33.	39.	45.
4.	10.	16.	22.	28.	34.	40.	46.
5.	11.	17.	23.	29.	35.	41.	47.
6.	12.	18.	24.	30.	36.	42.	48.

**ARCHITECTURAL REQUIREMENTS**

<b>WALL AND CEILING</b> Wall Material: <input type="text" value="ARGB 1.2m AFF, GB above"/> Finish: <input type="text" value="HPC"/> Ceiling Material: <input type="text" value="KLCT"/> Finish: <input type="text" value="PF"/>	<b>WALL PROTECTION</b> Type: <input type="text" value="FRP"/> <input checked="" type="checkbox"/> Corner Guards <input type="checkbox"/> Hand Rails <input type="checkbox"/> Bed Bumper / Locator Height: <input type="text" value="2185 mm"/> <input type="checkbox"/> Crash Rails <input type="checkbox"/> Chair Rail	<b>GLAZING</b> <input type="checkbox"/> Interior Glazing	<b>FLOORING TYPES</b> Material: <input type="text" value="PFC"/> Base: <input type="text" value="FCB"/>	<b>ROOM ACCESSORIES</b> <input type="checkbox"/> Coat Hooks <input type="checkbox"/> Ceiling Lift <input checked="" type="checkbox"/> Magnetic Whiteboard <input type="checkbox"/> Mirror <input type="checkbox"/> Infant Change Table <input type="checkbox"/> Privacy Curtain
--	---	---	--	---

- LEGEND:**
- WALL AND CEILING LEGEND:**
- AC Architectural Ceiling
  - ACT Acoustic Ceiling Tile
  - ACT-C Cleanroom
  - ARGB Abuse-Resistant Gypsum Board
  - GB Gypsum Board
  - IRGB Impact-Resistant Gypsum Board
  - KLCT Kitchen Lay-in Ceiling Tile
  - MMRGB Moisture and Mould-Resistant Gypsum Board
  - SACT Security Acoustic Ceiling Tile
- WALL FINISHES LEGEND:**
- EWC Epoxy Wall Coating
  - HPC High Performance Coating
  - PT Paint
- CEILING FINISHES LEGEND:**
- ECC Epoxy Ceiling Coating
  - HPC High Performance Coating
  - PF Prefinished
  - PT Paint
- WALL PROTECTION LEGEND:**
- ESRP Extruded Semi-Rigid PVCu Panel
  - FRL Fibre Reinforced Laminate
  - FRP Fibreglass Reinforced Plastic
  - PVV Protective Vinyl Wallcovering
  - RHIS Rigid High Impact Sheet
  - WSSP Wetwall Solid Surface Panel
  - WVV Wetroom Vinyl Wallcovering
- FLOOR FINISHES LEGEND:**
- CFS Concrete Floor Sealer
  - EFC Epoxy Floor Coating
  - PFC Polyurethane Floor Coating
  - RAF Rubber Athletic Flooring
  - RSF Rubber Sheet Flooring
  - SCF Seamless Cushioned Flooring
  - SDRF Static-Dissipative Rubber Sheet Flooring
  - SDVF Static-Dissipative Vinyl Sheet Flooring
  - VSF Vinyl Sheet Flooring
  - WSVF Wetroom Safety Vinyl Sheet Flooring
- FLOOR BASE LEGEND:**
- FCB Flash Cove Base
  - RB Rubber Base
  - SCF Seamless Cushioned Flooring

**DOORS**

Types:

Type	Qty	Size (mm)	Material	Finish	Side Lt.	Blinds	Protect.	Privacy Film	Function	Card Reader	Mag Lock	Auto Opener	Hold Open	Hinges	Accessory 1	Accessory 2	Accessory 3	Closer
B2	2	1830 x 2135	Solid Core	FRL	<input type="checkbox"/>	<input type="checkbox"/>	2 High	<input type="checkbox"/>	Push/Pull	<input type="checkbox"/>	<input type="checkbox"/>	<input type="checkbox"/>	<input checked="" type="checkbox"/>	Cont. Swing Clear	Astragal	Flush Bolt		Surface

Door Remarks:  Security Grille  Anti-barricade strategy

**MILLWORK AND SPECIALTY CASEWORK**

Storage Requirements:

**FINISHES**

Full-height Cabinet:

Upper Millwork:

Countertop:

Lower Millwork:

Shelf:

Remarks:

**Legend:**

Category	Min. Length (mm)	Motorized Adjustable Height	Standing Height	Specialty Casework
Category 0 - None		<input type="checkbox"/>	<input type="checkbox"/>	<input type="checkbox"/>
Category 1 - Low (1% - 4%)		<input type="checkbox"/>	<input type="checkbox"/>	<input type="checkbox"/>
Category 2 - Med (5% - 9%)		<input type="checkbox"/>	<input type="checkbox"/>	<input type="checkbox"/>
Category 3 - High (10% or Greater)		<input type="checkbox"/>	<input type="checkbox"/>	<input type="checkbox"/>

**MECHANICAL REQUIREMENTS**

<b>PLUMBING</b> (Quantity) Hand Hygiene Sink: <input type="text"/> Lavatory: <input type="text"/> Kitchen Sink: <input type="text"/> Seamless Kitchen Sink: <input type="text"/> Utility / Process Sink: <input type="text"/> Scrub Sink: <input type="text"/> Floor Sink: <input type="text"/> Plumbing Remarks: <input type="text"/>	Other Fixtures: <input type="checkbox"/> Shower <input type="checkbox"/> Eyewash Station <input type="checkbox"/> Tub <input type="checkbox"/> Eyewash/Shower Station <input type="checkbox"/> Ice Maker <input type="checkbox"/> Emergency Shower <input type="checkbox"/> Water Closet <input type="checkbox"/> Flush Rim Sink <input type="checkbox"/> Instantaneous Hot Water <input type="checkbox"/> Floor Drain <input type="checkbox"/> <input type="checkbox"/> Water Bottle Refill Station Other <input type="text"/>	<b>MED / NON-MED GASES</b> (Quantity) Oxygen: <input type="text"/> Medical Air: <input type="text"/> Medical Vacuum: <input type="text"/> Nitrous Oxide: <input type="text"/> CO2: <input type="text"/> AGSS: <input type="text"/> Nitrogen: <input type="text"/> Laboratory Air: <input type="text"/> Laboratory Vacuum: <input type="text"/> Utility Compressed Air: <input type="text"/> Gas Remarks: <input type="text"/>
---	--	---



**Appendix 1B Minimum Room Requirements**

Room Name:

Program Number(s):

1.	X1.02	7.		13.		19.		25.		31.		37.		43.
2.		8.		14.		20.		26.		32.		38.		44.
3.		9.		15.		21.		27.		33.		39.		45.
4.		10.		16.		22.		28.		34.		40.		46.
5.		11.		17.		23.		29.		35.		41.		47.
6.		12.		18.		24.		30.		36.		42.		48.

**ARCHITECTURAL REQUIREMENTS**

<b>WALL AND CEILING</b> Wall Material: <input type="text" value="ARGB 1.2m AFF, GB above"/> Finish: <input type="text" value="HPC"/> Ceiling Material: <input type="text" value="KLCT"/> Finish: <input type="text" value="PF"/>	<b>WALL PROTECTION</b> Type: <input type="text" value="FRP"/> <input checked="" type="checkbox"/> Corner Guards <input type="checkbox"/> Hand Rails <input type="checkbox"/> Bed Bumper / Locator Height: <input type="text" value="2185 mm"/> <input type="checkbox"/> Crash Rails <input type="checkbox"/> Chair Rail	<b>GLAZING</b> <input type="checkbox"/> Interior Glazing	<b>FLOORING TYPES</b> Material: <input type="text" value="PFC"/> Base: <input type="text" value="FCB"/>	<b>ROOM ACCESSORIES</b> <input type="checkbox"/> Coat Hooks <input type="checkbox"/> Ceiling Lift <input checked="" type="checkbox"/> Magnetic Whiteboard <input type="checkbox"/> Mirror <input type="checkbox"/> Infant Change Table <input type="checkbox"/> Privacy Curtain
--	---	---	--	---

- LEGEND:**
- WALL AND CEILING LEGEND:**
- AC Architectural Ceiling
  - ACT Acoustic Ceiling Tile
  - ACT-C Cleanroom
  - ARGB Abuse-Resistant Gypsum Board
  - GB Gypsum Board
  - IRGB Impact-Resistant Gypsum Board
  - KLCT Kitchen Lay-in Ceiling Tile
  - MMRGB Moisture and Mould-Resistant Gypsum Board
  - SACT Security Acoustic Ceiling Tile
- WALL FINISHES LEGEND:**
- EWC Epoxy Wall Coating
  - HPC High Performance Coating
  - PT Paint
- CEILING FINISHES LEGEND:**
- ECC Epoxy Ceiling Coating
  - HPC High Performance Coating
  - PF Prefinished
  - PT Paint
- WALL PROTECTION LEGEND:**
- ESRP Extruded Semi-Rigid PVCu Panel
  - FRL Fibre Reinforced Laminate
  - FRP Fibreglass Reinforced Plastic
  - PVV Protective Vinyl Wallcovering
  - RHIS Rigid High Impact Sheet
  - WSSP Wetwall Solid Surface Panel
  - WVV Wetroom Vinyl Wallcovering
- FLOOR FINISHES LEGEND:**
- CFS Concrete Floor Sealer
  - EFC Epoxy Floor Coating
  - PFC Polyurethane Floor Coating
  - RAF Rubber Athletic Flooring
  - RSF Rubber Sheet Flooring
  - SCF Seamless Cushioned Flooring
  - SDRF Static-Dissipative Rubber Sheet Flooring
  - SDVF Static-Dissipative Vinyl Sheet Flooring
  - VSF Vinyl Sheet Flooring
  - WSVF Wetroom Safety Vinyl Sheet Flooring
- FLOOR BASE LEGEND:**
- FCB Flash Cove Base
  - RB Rubber Base
  - SCF Seamless Cushioned Flooring

**DOORS**

Types:

Type	Qty	Size (mm)	Material	Finish	Side Lt.	Blinds	Protect.	Privacy Film	Function	Card Reader	Mag Lock	Auto Opener	Hold Open	Hinges	Accessory 1	Accessory 2	Accessory 3	Closer
C	1	915 x 2135	Solid Core	FRL	<input type="checkbox"/>	<input type="checkbox"/>	2 High	<input type="checkbox"/>	Passage	<input type="checkbox"/>	<input type="checkbox"/>	<input type="checkbox"/>	<input checked="" type="checkbox"/>	Cont. Swing Clear				Surface

Door Remarks:  Security Grille  Anti-barricade strategy



**MECHANICAL REQUIREMENTS**

<b>PLUMBING</b> (Quantity) Hand Hygiene Sink: <input type="text"/> Lavatory: <input type="text"/> Kitchen Sink: <input type="text"/> Seamless Kitchen Sink: <input type="text"/> Utility / Process Sink: <input type="text"/> Scrub Sink: <input type="text"/> Floor Sink: <input type="text"/> Plumbing Remarks: <input type="text"/>	Other Fixtures: <input type="checkbox"/> Shower <input type="checkbox"/> Eyewash Station <input type="checkbox"/> Tub <input type="checkbox"/> Eyewash/Shower Station <input type="checkbox"/> Ice Maker <input type="checkbox"/> Emergency Shower <input type="checkbox"/> Water Closet <input type="checkbox"/> Flush Rim Sink <input type="checkbox"/> Instantaneous Hot Water <input type="checkbox"/> Floor Drain <input type="checkbox"/> <input type="checkbox"/> Water Bottle Refill Station Other <input type="text"/>	<b>MED / NON-MED GASES</b> (Quantity) Oxygen: <input type="text"/> Medical Air: <input type="text"/> Medical Vacuum: <input type="text"/> Nitrous Oxide: <input type="text"/> CO2: <input type="text"/> AGSS: <input type="text"/> Nitrogen: <input type="text"/> Laboratory Air: <input type="text"/> Laboratory Vacuum: <input type="text"/> Utility Compressed Air: <input type="text"/> Gas Remarks: <input type="text"/>
---	--	---

**Appendix 1B Minimum Room Requirements**

Room Name:

Program Number(s):

1. X1.04	7.	13.	19.	25.	31.	37.	43.
2. X1.05	8.	14.	20.	26.	32.	38.	44.
3.	9.	15.	21.	27.	33.	39.	45.
4.	10.	16.	22.	28.	34.	40.	46.
5.	11.	17.	23.	29.	35.	41.	47.
6.	12.	18.	24.	30.	36.	42.	48.

**ARCHITECTURAL REQUIREMENTS**

<b>WALL AND CEILING</b> Wall Material: <input type="text" value="MMRGB"/> Finish: <input type="text" value="HPC"/> Ceiling Material: <input type="text" value="KLCT"/> Finish: <input type="text" value="PF"/>	<b>WALL PROTECTION</b> Type: <input type="text" value="FRP"/> <input checked="" type="checkbox"/> Corner Guards <input type="checkbox"/> Hand Rails <input type="checkbox"/> Bed Bumper / Locator Height: <input type="text" value="2185 mm"/> <input type="checkbox"/> Crash Rails <input type="checkbox"/> Chair Rail	<b>GLAZING</b> <input type="checkbox"/> Interior Glazing	<b>FLOORING TYPES</b> Material: <input type="text" value="PFC"/> Base: <input type="text" value="FCB"/>	<b>ROOM ACCESSORIES</b> <input checked="" type="checkbox"/> Coat Hooks <input type="checkbox"/> Ceiling Lift <input type="checkbox"/> Magnetic Whiteboard <input type="checkbox"/> Mirror <input type="checkbox"/> Infant Change Table <input type="checkbox"/> Privacy Curtain
--	---	---	--	---

- LEGEND:**
- WALL AND CEILING LEGEND:**
- AC Architectural Ceiling
  - ACT Acoustic Ceiling Tile
  - ACT-C Cleanroom
  - ARGB Abuse-Resistant Gypsum Board
  - GB Gypsum Board
  - IRGB Impact-Resistant Gypsum Board
  - KLCT Kitchen Lay-in Ceiling Tile
  - MMRGB Moisture and Mould-Resistant Gypsum Board
  - SACT Security Acoustic Ceiling Tile
- WALL FINISHES LEGEND:**
- EWC Epoxy Wall Coating
  - HPC High Performance Coating
  - PT Paint
- CEILING FINISHES LEGEND:**
- ECC Epoxy Ceiling Coating
  - HPC High Performance Coating
  - PF Prefinished
  - PT Paint
- WALL PROTECTION LEGEND:**
- ESRP Extruded Semi-Rigid PVCu Panel
  - FRL Fibre Reinforced Laminate
  - FRP Fibreglass Reinforced Plastic
  - PVV Protective Vinyl Wallcovering
  - RHIS Rigid High Impact Sheet
  - WSSP Wetwall Solid Surface Panel
  - WVV Wetroom Vinyl Wallcovering
- FLOOR FINISHES LEGEND:**
- CFS Concrete Floor Sealer
  - EFC Epoxy Floor Coating
  - PFC Polyurethane Floor Coating
  - RAF Rubber Athletic Flooring
  - RSF Rubber Sheet Flooring
  - SCF Seamless Cushioned Flooring
  - SDRF Static-Dissipative Rubber Sheet Flooring
  - SDVF Static-Dissipative Vinyl Sheet Flooring
  - VSF Vinyl Sheet Flooring
  - WSVF Wetroom Safety Vinyl Sheet Flooring
- FLOOR BASE LEGEND:**
- FCB Flash Cove Base
  - RB Rubber Base
  - SCF Seamless Cushioned Flooring

**DOORS**

Types:

Type	Qty	Size (mm)	Material	Finish	Side Lt.	Blinds	Protect.	Privacy Film	Function	Card Reader	Mag Lock	Auto Opener	Hold Open	Hinges	Accessory 1	Accessory 2	Accessory 3	Closer

Door Remarks:  Security Grille  Anti-barricade strategy

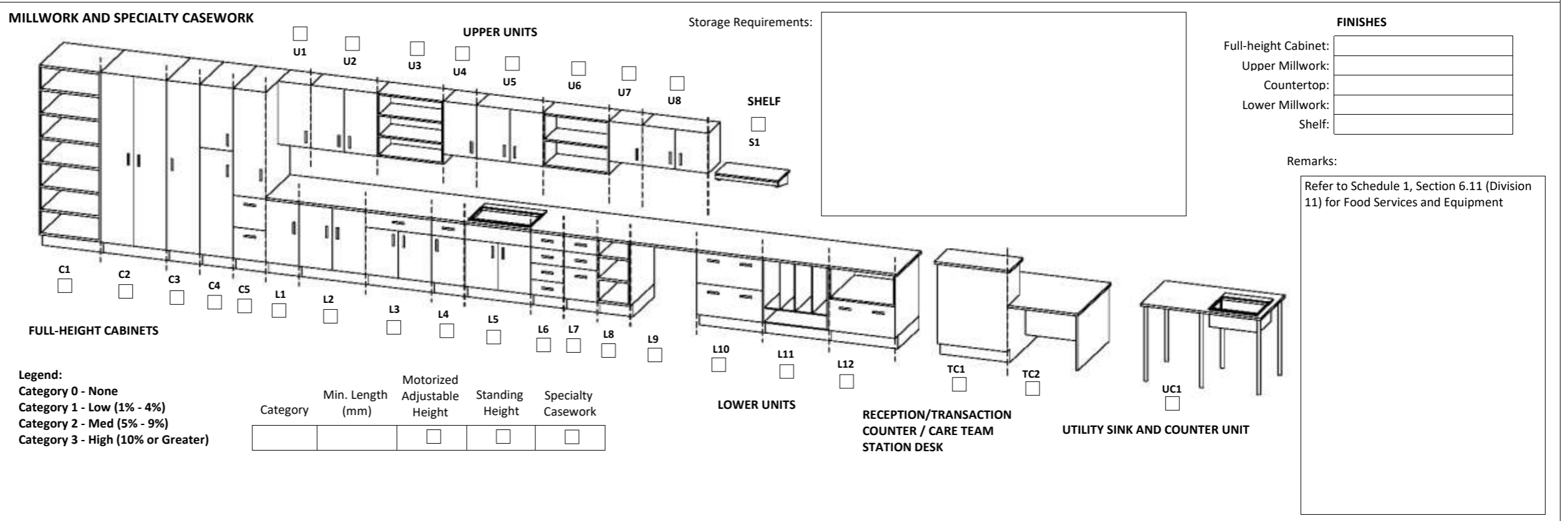

**MECHANICAL REQUIREMENTS**

<b>PLUMBING</b> (Quantity) Hygiene Sink: <input type="text"/> Lavatory: <input type="text"/> Kitchen Sink: <input type="text"/> Seamless Kitchen Sink: <input type="text"/> Utility / Process Sink: <input type="text"/> Scrub Sink: <input type="text"/> Floor Sink: <input type="text"/>	Other Fixtures: <input type="checkbox"/> Shower <input type="checkbox"/> Tub <input type="checkbox"/> Ice Maker <input type="checkbox"/> Water Closet <input type="checkbox"/> Instantaneous Hot Water	<input type="checkbox"/> Eyewash Station <input type="checkbox"/> Eyewash/Shower Station <input type="checkbox"/> Emergency Shower <input type="checkbox"/> Flush Rim Sink <input checked="" type="checkbox"/> Floor Drain <input type="checkbox"/> Water Bottle Refill Station	<b>MED / NON-MED GASES</b> (Quantity) Oxygen: <input type="text"/> Medical Air: <input type="text"/> Medical Vacuum: <input type="text"/> Nitrous Oxide: <input type="text"/> CO2: <input type="text"/> AGSS: <input type="text"/> Nitrogen: <input type="text"/> Laboratory Air: <input type="text"/> Laboratory Vacuum: <input type="text"/> Utility Compressed Air: <input type="text"/>
---	---	---	--

Plumbing Remarks: Provide indirect drain to funnel floor drain located outside of the walk in. Placement not to impede door, path of travel and cart movement.

Gas Remarks:

**Appendix 1B Minimum Room Requirements**

Room Name:

Program Number(s):

1. X1.06	7.	13.	19.	25.	31.	37.	43.
2.	8.	14.	20.	26.	32.	38.	44.
3.	9.	15.	21.	27.	33.	39.	45.
4.	10.	16.	22.	28.	34.	40.	46.
5.	11.	17.	23.	29.	35.	41.	47.
6.	12.	18.	24.	30.	36.	42.	48.

**ARCHITECTURAL REQUIREMENTS**

<b>WALL AND CEILING</b> Wall Material: <input type="text" value="MMRGB"/> Finish: <input type="text" value="HPC"/> Ceiling Material: <input type="text" value="KLCT"/> Finish: <input type="text" value="PF"/>	<b>WALL PROTECTION</b> Type: <input type="text" value="FRP"/> <input type="checkbox"/> Corner Guards <input type="checkbox"/> Hand Rails <input type="checkbox"/> Bed Bumper / Locator Height: <input type="text" value="1350 mm"/> <input type="checkbox"/> Crash Rails <input type="checkbox"/> Chair Rail	<b>GLAZING</b> <input type="checkbox"/> Interior Glazing	<b>FLOORING TYPES</b> Material: <input type="text" value="WSVF"/> Base: <input type="text" value="FCB"/>	<b>ROOM ACCESSORIES</b> <input type="checkbox"/> Coat Hooks <input type="checkbox"/> Ceiling Lift <input type="checkbox"/> Magnetic Whiteboard <input type="checkbox"/> Mirror <input type="checkbox"/> Infant Change Table <input type="checkbox"/> Privacy Curtain
--	--	---	---	--

- LEGEND:**
- WALL AND CEILING LEGEND:**
- AC Architectural Ceiling
  - ACT Acoustic Ceiling Tile
  - ACT-C Cleanroom
  - ARGB Abuse-Resistant Gypsum Board
  - GB Gypsum Board
  - IRGB Impact-Resistant Gypsum Board
  - KLCT Kitchen Lay-in Ceiling Tile
  - MMRGB Moisture and Mould-Resistant Gypsum Board
  - SACT Security Acoustic Ceiling Tile
- WALL FINISHES LEGEND:**
- EWC Epoxy Wall Coating
  - HPC High Performance Coating
  - PT Paint
- CEILING FINISHES LEGEND:**
- ECC Epoxy Ceiling Coating
  - HPC High Performance Coating
  - PF Prefinished
  - PT Paint
- WALL PROTECTION LEGEND:**
- ESRP Extruded Semi-Rigid PVCu Panel
  - FRL Fibre Reinforced Laminate
  - FRP Fibreglass Reinforced Plastic
  - PVV Protective Vinyl Wallcovering
  - RHIS Rigid High Impact Sheet
  - WSSP Wetwall Solid Surface Panel
  - WVV Wetroom Vinyl Wallcovering
- FLOOR FINISHES LEGEND:**
- CFS Concrete Floor Sealer
  - EFC Epoxy Floor Coating
  - PFC Polyurethane Floor Coating
  - RAF Rubber Athletic Flooring
  - RSF Rubber Sheet Flooring
  - SCF Seamless Cushioned Flooring
  - SDRF Static-Dissipative Rubber Sheet Flooring
  - SDVF Static-Dissipative Vinyl Sheet Flooring
  - VSF Vinyl Sheet Flooring
  - WSVF Wetroom Safety Vinyl Sheet Flooring
- FLOOR BASE LEGEND:**
- FCB Flash Cove Base
  - RB Rubber Base
  - SCF Seamless Cushioned Flooring

**DOORS**

Types:

Type	Qty	Size (mm)	Material	Finish	Side Lt.	Blinds	Protect.	Privacy Film	Function	Card Reader	Mag Lock	Auto Opener	Hold Open	Hinges	Accessory 1	Accessory 2	Accessory 3	Closer

Door Remarks:  Security Grille  Anti-barricade strategy

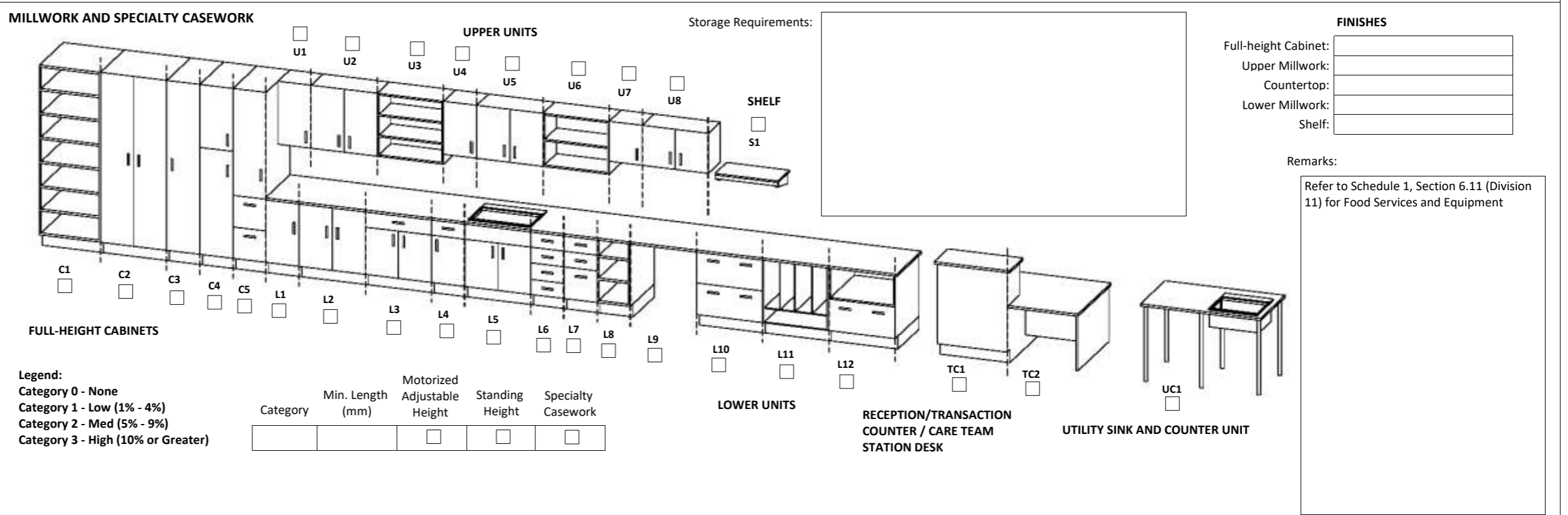

**MECHANICAL REQUIREMENTS**

<b>PLUMBING</b> (Quantity) Hygiene Sink: <input type="text"/> Lavatory: <input type="text"/> Kitchen Sink: <input type="text"/> Seamless Kitchen Sink: <input type="text"/> Utility / Process Sink: <input type="text"/> Scrub Sink: <input type="text"/> Floor Sink: <input type="text"/>	Other Fixtures: <input type="checkbox"/> Shower <input type="checkbox"/> Eyewash Station <input type="checkbox"/> Tub <input type="checkbox"/> Eyewash/Shower Station <input type="checkbox"/> Ice Maker <input type="checkbox"/> Emergency Shower <input type="checkbox"/> Water Closet <input checked="" type="checkbox"/> Floor Drain <input type="checkbox"/> Instantaneous Hot Water <input type="checkbox"/> Water Bottle Refill Station Other: <input type="text"/>	<b>MED / NON-MED GASES</b> (Quantity) Oxygen: <input type="text"/> Medical Air: <input type="text"/> Medical Vacuum: <input type="text"/> Nitrous Oxide: <input type="text"/> CO2: <input type="text"/> AGSS: <input type="text"/> Nitrogen: <input type="text"/> Laboratory Air: <input type="text"/> Laboratory Vacuum: <input type="text"/> Utility Compressed Air: <input type="text"/>
Plumbing Remarks: Provide indirect drain to funnel floor drain located outside of the walk in. Placement not to impede door, path of travel and cart movement.	Gas Remarks: <input type="text"/>	



---

# New Surrey Hospital & BC Cancer Centre

MINIMUM ROOM REQUIREMENTS

## Y. Staff Facilities

---

**Appendix 1B Minimum Room Requirements**

Room Name:

Program Number(s):	1. Y3.02	7.	13.	19.	25.	31.	37.	43.
	2.	8.	14.	20.	26.	32.	38.	44.
	3.	9.	15.	21.	27.	33.	39.	45.
	4.	10.	16.	22.	28.	34.	40.	46.
	5.	11.	17.	23.	29.	35.	41.	47.
	6.	12.	18.	24.	30.	36.	42.	48.

**ARCHITECTURAL REQUIREMENTS**

<b>WALL AND CEILING</b> Wall Material: <input type="text" value="ARGB 1.2m AFF, GB above"/> Finish: <input type="text" value="PT"/> Ceiling Material: <input type="text" value="ACT"/> Finish: <input type="text" value="PF"/>	<b>WALL PROTECTION</b> Type: <input type="text" value="PVW"/> <input checked="" type="checkbox"/> Corner Guards <input type="checkbox"/> Hand Rails <input type="checkbox"/> Bed Bumper / Locator Height: <input type="text" value="2185 mm"/> <input type="checkbox"/> Crash Rails <input type="checkbox"/> Chair Rail	<b>GLAZING</b> <input type="checkbox"/> Interior Glazing	<b>FLOORING TYPES</b> Material: <input type="text" value="VSF"/> Base: <input type="text" value="FCB"/>	<b>ROOM ACCESSORIES</b> <input type="checkbox"/> Coat Hooks <input type="checkbox"/> Ceiling Lift <input type="checkbox"/> Magnetic Whiteboard <input type="checkbox"/> Mirror <input type="checkbox"/> Infant Change Table <input type="checkbox"/> Privacy Curtain
--	---	---	--	--

- LEGEND:**
- WALL AND CEILING LEGEND:**
- AC Architectural Ceiling
  - ACT Acoustic Ceiling Tile
  - ACT-C Cleanroom
  - ARGB Abuse-Resistant Gypsum Board
  - GB Gypsum Board
  - IRGB Impact-Resistant Gypsum Board
  - KLCT Kitchen Lay-in Ceiling Tile
  - MMRGB Moisture and Mould-Resistant Gypsum Board
  - SACT Security Acoustic Ceiling Tile
- WALL FINISHES LEGEND:**
- EWC Epoxy Wall Coating
  - HPC High Performance Coating
  - PT Paint
- CEILING FINISHES LEGEND:**
- ECC Epoxy Ceiling Coating
  - HPC High Performance Coating
  - PF Prefinished
  - PT Paint
- WALL PROTECTION LEGEND:**
- ESRP Extruded Semi-Rigid PVCu Panel
  - FRL Fibre Reinforced Laminate
  - FRP Fibreglass Reinforced Plastic
  - PVW Protective Vinyl Wallcovering
  - RHIS Rigid High Impact Sheet
  - WSSP Wetwall Solid Surface Panel
  - WVV Wetroom Vinyl Wallcovering
- FLOOR FINISHES LEGEND:**
- CFS Concrete Floor Sealer
  - EFC Epoxy Floor Coating
  - PFC Polyurethane Floor Coating
  - RAF Rubber Athletic Flooring
  - RSF Rubber Sheet Flooring
  - SCF Seamless Cushioned Flooring
  - SDRF Static-Dissipative Rubber Sheet Flooring
  - SDVF Static-Dissipative Vinyl Sheet Flooring
  - VSF Vinyl Sheet Flooring
  - WSVF Wetroom Safety Vinyl Sheet Flooring
- FLOOR BASE LEGEND:**
- FCB Flash Cove Base
  - RB Rubber Base
  - SCF Seamless Cushioned Flooring

**DOORS**

Types:

Type:Qty:	Size (mm):	Material:	Finish:	Side Lt:	Blinds:	Protect.:	Privacy Film:	Function:	Card Reader:	Mag Lock:	Auto Opener:	Hold Open:	Hinges:	Accessory 1:	Accessory 2:	Accessory 3:	Closer:

Door Remarks:  Security Grille  Anti-barricade strategy

**MILLWORK AND SPECIALTY CASEWORK**

Storage Requirements: Provide (30) three tiered lockers

**UPPER UNITS:** U1, U2, U3, U4, U5, U6, U7, U8

**LOWER UNITS:** L1, L2, L3, L4, L5, L6, L7, L8, L9, L10, L11, L12

**RECEPTION/TRANSACTION COUNTER / CARE TEAM STATION DESK:** TC1, TC2

**UTILITY SINK AND COUNTER UNIT:** UC1

**SHELF:** S1

**FULL-HEIGHT CABINETS:** C1, C2, C3, C4, C5

**Legend:**

Category	Min. Length (mm)	Motorized Adjustable Height	Standing Height	Specialty Casework
Category 0 - None				
Category 1 - Low (1% - 4%)				
Category 2 - Med (5% - 9%)				
Category 3 - High (10% or Greater)				

**FINISHES**

Full-height Cabinet:

Upper Millwork:

Countertop:

Lower Millwork:

Shelf:

Remarks:

**MECHANICAL REQUIREMENTS**

<b>PLUMBING</b> (Quantity) Hand Hygiene Sink: <input type="text"/> Lavatory: <input type="text"/> Kitchen Sink: <input type="text"/> Seamless Kitchen Sink: <input type="text"/> Utility / Process Sink: <input type="text"/> Scrub Sink: <input type="text"/> Floor Sink: <input type="text"/> Plumbing Remarks: <input type="text"/>	Other Fixtures: <input type="checkbox"/> Shower <input type="checkbox"/> Eyewash Station <input type="checkbox"/> Tub <input type="checkbox"/> Eyewash/Shower Station <input type="checkbox"/> Ice Maker <input type="checkbox"/> Emergency Shower <input type="checkbox"/> Water Closet <input type="checkbox"/> Flush Rim Sink <input type="checkbox"/> Instantaneous Hot Water <input type="checkbox"/> Floor Drain <input type="checkbox"/> <input type="checkbox"/> Water Bottle Refill Station Other <input type="text"/>	<b>MED / NON-MED GASES</b> (Quantity) Oxygen: <input type="text"/> Medical Air: <input type="text"/> Medical Vacuum: <input type="text"/> Nitrous Oxide: <input type="text"/> CO2: <input type="text"/> AGSS: <input type="text"/> Nitrogen: <input type="text"/> Laboratory Air: <input type="text"/> Laboratory Vacuum: <input type="text"/> Utility Compressed Air: <input type="text"/> Gas Remarks: <input type="text"/>
---	--	---

**Appendix 1B Minimum Room Requirements**

Room Name:

Program Number(s):

1.	Y1.13	7.		13.		19.		25.		31.		37.		43.
2.		8.		14.		20.		26.		32.		38.		44.
3.		9.		15.		21.		27.		33.		39.		45.
4.		10.		16.		22.		28.		34.		40.		46.
5.		11.		17.		23.		29.		35.		41.		47.
6.		12.		18.		24.		30.		36.		42.		48.

**ARCHITECTURAL REQUIREMENTS**

<b>WALL AND CEILING</b> Wall Material: <input type="text" value="ARGB 1.2m AFF, GB above"/> Finish: <input type="text" value="PT"/> Ceiling Material: <input type="text" value="ACT"/> Finish: <input type="text" value="PF"/>		<b>WALL PROTECTION</b> Type: <input type="text" value="PVW"/> <input checked="" type="checkbox"/> Corner Guards <input checked="" type="checkbox"/> Hand Rails <input type="checkbox"/> Bed Bumper / Locator Height: <input type="text" value="2185 mm"/> <input type="checkbox"/> Crash Rails <input type="checkbox"/> Chair Rail			<b>GLAZING</b> <input checked="" type="checkbox"/> Interior Glazing		<b>FLOORING TYPES</b> Material: <input type="text" value="RAF"/> Base: <input type="text" value="FCB"/>		<b>ROOM ACCESSORIES</b> <input checked="" type="checkbox"/> Coat Hooks <input type="checkbox"/> Ceiling Lift <input checked="" type="checkbox"/> Magnetic Whiteboard <input type="checkbox"/> Mirror <input type="checkbox"/> Infant Change Table <input type="checkbox"/> Privacy Curtain		
--	--	--	--	--	--	--	--	--	--	--	--

- LEGEND:**
- WALL AND CEILING LEGEND:**
- AC Architectural Ceiling
  - ACT Acoustic Ceiling Tile
  - ACT-C Cleanroom
  - ARGB Abuse-Resistant Gypsum Board
  - GB Gypsum Board
  - IRGB Impact-Resistant Gypsum Board
  - KLCT Kitchen Lay-in Ceiling Tile
  - MMRGB Moisture and Mould-Resistant Gypsum Board
  - SACT Security Acoustic Ceiling Tile
- WALL FINISHES LEGEND:**
- EWC Epoxy Wall Coating
  - HPC High Performance Coating
  - PT Paint
- CEILING FINISHES LEGEND:**
- ECC Epoxy Ceiling Coating
  - HPC High Performance Coating
  - PF Prefinished
  - PT Paint
- WALL PROTECTION LEGEND:**
- ESRP Extruded Semi-Rigid PVCu Panel
  - FRL Fibre Reinforced Laminate
  - FRP Fibreglass Reinforced Plastic
  - PVW Protective Vinyl Wallcovering
  - RHIS Rigid High Impact Sheet
  - WSSP Wetwall Solid Surface Panel
  - WVV Wetroom Vinyl Wallcovering
- FLOOR FINISHES LEGEND:**
- CFS Concrete Floor Sealer
  - EFC Epoxy Floor Coating
  - PFC Polyurethane Floor Coating
  - RAF Rubber Athletic Flooring
  - RSF Rubber Sheet Flooring
  - SCF Seamless Cushioned Flooring
  - SDRF Static-Dissipative Rubber Sheet Flooring
  - SDVF Static-Dissipative Vinyl Sheet Flooring
  - VSF Vinyl Sheet Flooring
  - WSVF Wetroom Safety Vinyl Sheet Flooring
- FLOOR BASE LEGEND:**
- FCB Flash Cove Base
  - RB Rubber Base
  - SCF Seamless Cushioned Flooring

**DOORS**

Types:

Type	Qty	Size (mm)	Material	Finish	Side Lt.	Blinds	Protect.	Privacy Film	Function	Card Reader	Mag Lock	Auto Opener	Hold Open	Hinges	Accessory 1	Accessory 2	Accessory 3	Closer
B2	1	1830 x 2135	Solid Core	FRL	<input type="checkbox"/>	<input type="checkbox"/>	2 High	<input type="checkbox"/>	Storeroom	<input checked="" type="checkbox"/>	<input type="checkbox"/>	<input type="checkbox"/>	<input type="checkbox"/>	Butt Hinge	Astragal	Flush Bolt		Surface

Door Remarks:  Security Grille  Anti-barricade strategy

**MILLWORK AND SPECIALTY CASEWORK**

Storage Requirements: Refer to Schedule 1 for cubby storage requirements. Provide cubby storage for gym bags.

**UPPER UNITS** (U1-U8)

**LOWER UNITS** (L1-L12)

**RECEPTION/TRANSACTION COUNTER / CARE TEAM STATION DESK** (TC1, TC2)

**UTILITY SINK AND COUNTER UNIT** (UC1)

**FINISHES**

- Full-height Cabinet:
- Upper Millwork:
- Countertop:
- Lower Millwork:
- Shelf:

Remarks:

**MECHANICAL REQUIREMENTS**

<b>PLUMBING</b> (Quantity) Hygiene Sink: <input type="text" value="1"/> Lavatory: <input type="text"/> Kitchen Sink: <input type="text"/> Seamless Kitchen Sink: <input type="text"/> Utility / Process Sink: <input type="text"/> Scrub Sink: <input type="text"/> Floor Sink: <input type="text"/>							Other Fixtures: <input type="checkbox"/> Shower <input type="checkbox"/> Eyewash Station <input type="checkbox"/> Tub <input type="checkbox"/> Eyewash/Shower Station <input type="checkbox"/> Ice Maker <input type="checkbox"/> Emergency Shower <input type="checkbox"/> Water Closet <input type="checkbox"/> Flush Rim Sink <input type="checkbox"/> Instantaneous Hot Water <input checked="" type="checkbox"/> Floor Drain <input checked="" type="checkbox"/> Water Bottle Refill Station Other: <input type="text"/>				<b>MED / NON-MED GASES</b> (Quantity) Oxygen: <input type="text"/> Medical Air: <input type="text"/> Medical Vacuum: <input type="text"/> Nitrous Oxide: <input type="text"/> CO2: <input type="text"/> AGSS: <input type="text"/> Nitrogen: <input type="text"/> Laboratory Air: <input type="text"/> Laboratory Vacuum: <input type="text"/> Utility Compressed Air: <input type="text"/>				
Plumbing Remarks: <input type="text"/>							Gas Remarks: <input type="text"/>				Gas Remarks: <input type="text"/>				



**Appendix 1B Minimum Room Requirements**

Room Name:

Program Number(s):

1. Y3.01	7.	13.	19.	25.	31.	37.	43.
2.	8.	14.	20.	26.	32.	38.	44.
3.	9.	15.	21.	27.	33.	39.	45.
4.	10.	16.	22.	28.	34.	40.	46.
5.	11.	17.	23.	29.	35.	41.	47.
6.	12.	18.	24.	30.	36.	42.	48.

**ARCHITECTURAL REQUIREMENTS**

<b>WALL AND CEILING</b> Wall Material: <input type="text" value="GB"/> Finish: <input type="text" value="PT"/> Ceiling Material: <input type="text" value="ACT"/> Finish: <input type="text" value="PF"/>	<b>WALL PROTECTION</b> Type: <input type="text"/> Height: <input type="text"/> <input checked="" type="checkbox"/> Corner Guards <input type="checkbox"/> Hand Rails <input type="checkbox"/> Bed Bumper / Locator <input type="checkbox"/> Crash Rails <input type="checkbox"/> Chair Rail	<b>GLAZING</b> <input checked="" type="checkbox"/> Interior Glazing	<b>FLOORING TYPES</b> Material: <input type="text" value="VSF"/> Base: <input type="text" value="FCB"/>	<b>ROOM ACCESSORIES</b> <input checked="" type="checkbox"/> Coat Hooks <input type="checkbox"/> Ceiling Lift <input checked="" type="checkbox"/> Magnetic Whiteboard <input type="checkbox"/> Mirror <input type="checkbox"/> Infant Change Table <input type="checkbox"/> Privacy Curtain
---	--	--	--	--

- LEGEND:**
- WALL AND CEILING LEGEND:**
- AC Architectural Ceiling
  - ACT Acoustic Ceiling Tile
  - ACT-C Cleanroom
  - ARGB Abuse-Resistant Gypsum Board
  - GB Gypsum Board
  - IRGB Impact-Resistant Gypsum Board
  - KLCT Kitchen Lay-in Ceiling Tile
  - MMRGB Moisture and Mould-Resistant Gypsum Board
  - SACT Security Acoustic Ceiling Tile
- WALL FINISHES LEGEND:**
- EWC Epoxy Wall Coating
  - HPC High Performance Coating
  - PT Paint
- CEILING FINISHES LEGEND:**
- ECC Epoxy Ceiling Coating
  - HPC High Performance Coating
  - PF Prefinished
  - PT Paint
- WALL PROTECTION LEGEND:**
- ESRP Extruded Semi-Rigid PVCu Panel
  - FRL Fibre Reinforced Laminate
  - FRP Fibreglass Reinforced Plastic
  - PVV Protective Vinyl Wallcovering
  - RHIS Rigid High Impact Sheet
  - WSSP Wetwall Solid Surface Panel
  - WVV Wetroom Vinyl Wallcovering
- FLOOR FINISHES LEGEND:**
- CFS Concrete Floor Sealer
  - EFC Epoxy Floor Coating
  - PFC Polyurethane Floor Coating
  - RAF Rubber Athletic Flooring
  - RSF Rubber Sheet Flooring
  - SCF Seamless Cushioned Flooring
  - SDRF Static-Dissipative Rubber Sheet Flooring
  - SDVF Static-Dissipative Vinyl Sheet Flooring
  - VSF Vinyl Sheet Flooring
  - WSVF Wetroom Safety Vinyl Sheet Flooring
- FLOOR BASE LEGEND:**
- FCB Flash Cove Base
  - RB Rubber Base
  - SCF Seamless Cushioned Flooring

**DOORS**

Types:

Type	Qty	Size (mm)	Material	Finish	Side Lt.	Blinds	Protect.	Privacy Film	Function	Card Reader	Mag Lock	Auto Opener	Hold Open	Hinges	Accessory 1	Accessory 2	Accessory 3	Closer
B	1	915 x 2135	Solid Core	FRL			1 Low		Storeroom	<input checked="" type="checkbox"/>				Butt Hinge				Surface

**DOOR REMARKS:**

Security Grille  
 Anti-barricade strategy

**MILLWORK AND SPECIALTY CASEWORK**

Storage Requirements:

**UPPER UNITS:** U1, U2, U3, U4, U5, U6, U7, U8

**LOWER UNITS:** L1, L2, L3, L4, L5, L6, L7, L8, L9, L10, L11, L12

**RECEPTION/TRANSACTION COUNTER / CARE TEAM STATION DESK:** TC1, TC2

**UTILITY SINK AND COUNTER UNIT:** UC1

**SHELF:** S1

**FULL-HEIGHT CABINETS:** C1, C2, C3, C4, C5

**Legend:**

Category	Min. Length (mm)	Motorized Adjustable Height	Standing Height	Specialty Casework
2	3000	<input type="checkbox"/>	<input checked="" type="checkbox"/>	<input type="checkbox"/>

**FINISHES**

Full-height Cabinet:   
 Upper Millwork:   
 Countertop:   
 Lower Millwork:   
 Shelf:

**REMARKS:**

**MECHANICAL REQUIREMENTS**

<b>PLUMBING</b> (Quantity) Hand Hygiene Sink: <input type="text" value="1"/> Lavatory: <input type="text"/> Kitchen Sink: <input type="text" value="1"/> Seamless Kitchen Sink: <input type="text"/> Utility / Process Sink: <input type="text"/> Scrub Sink: <input type="text"/> Floor Sink: <input type="text"/> Plumbing Remarks: <input type="text"/>	Other Fixtures: <input type="checkbox"/> Shower <input type="checkbox"/> Tub <input type="checkbox"/> Ice Maker <input type="checkbox"/> Water Closet <input type="checkbox"/> Instantaneous Hot Water <input type="checkbox"/> Ewwash Station <input type="checkbox"/> Ewwash/Shower Station <input type="checkbox"/> Emergency Shower <input type="checkbox"/> Flush Rim Sink <input type="checkbox"/> Floor Drain <input checked="" type="checkbox"/> Water Bottle Refill Station Other: <input type="text"/>	<b>MED / NON-MED GASES</b> (Quantity) Oxygen: <input type="text"/> Medical Air: <input type="text"/> Medical Vacuum: <input type="text"/> Nitrous Oxide: <input type="text"/> CO2: <input type="text"/> AGSS: <input type="text"/> Nitrogen: <input type="text"/> Laboratory Air: <input type="text"/> Laboratory Vacuum: <input type="text"/> Utility Compressed Air: <input type="text"/> Gas Remarks: <input type="text"/>
---	--	---

**Appendix 1B Minimum Room Requirements**

Room Name:

Program Number(s):

1. Y3.06	7.	13.	19.	25.	31.	37.	43.
2.	8.	14.	20.	26.	32.	38.	44.
3.	9.	15.	21.	27.	33.	39.	45.
4.	10.	16.	22.	28.	34.	40.	46.
5.	11.	17.	23.	29.	35.	41.	47.
6.	12.	18.	24.	30.	36.	42.	48.

**ARCHITECTURAL REQUIREMENTS**

<b>WALL AND CEILING</b> Wall Material: <input type="text" value="GB"/> Finish: <input type="text" value="PT"/> Ceiling Material: <input type="text" value="ACT"/> Finish: <input type="text" value="PF"/>	<b>WALL PROTECTION</b> Type: <input type="text"/> Height: <input type="text"/> <input type="checkbox"/> Corner Guards <input type="checkbox"/> Hand Rails <input type="checkbox"/> Bed Bumper / Locator <input type="checkbox"/> Crash Rails <input type="checkbox"/> Chair Rail	<b>GLAZING</b> <input type="checkbox"/> Interior Glazing	<b>FLOORING TYPES</b> Material: <input type="text" value="VSF"/> Base: <input type="text" value="FCB"/>	<b>ROOM ACCESSORIES</b> <input checked="" type="checkbox"/> Coat Hooks <input type="checkbox"/> Ceiling Lift <input checked="" type="checkbox"/> Magnetic Whiteboard <input checked="" type="checkbox"/> Mirror <input type="checkbox"/> Infant Change Table <input type="checkbox"/> Privacy Curtain
---	---	---	--	---

- LEGEND:**
- WALL AND CEILING LEGEND:**
- AC Architectural Ceiling
  - ACT Acoustic Ceiling Tile
  - ACT-C Cleanroom
  - ARGB Abuse-Resistant Gypsum Board
  - GB Gypsum Board
  - IRGB Impact-Resistant Gypsum Board
  - KLCT Kitchen Lay-in Ceiling Tile
  - MMRGB Moisture and Mould-Resistant Gypsum Board
  - SACT Security Acoustic Ceiling Tile
- WALL FINISHES LEGEND:**
- EWC Epoxy Wall Coating
  - HPC High Performance Coating
  - PT Paint
- CEILING FINISHES LEGEND:**
- ECC Epoxy Ceiling Coating
  - HPC High Performance Coating
  - PF Prefinished
  - PT Paint
- WALL PROTECTION LEGEND:**
- ESRP Extruded Semi-Rigid PVCu Panel
  - FRL Fibre Reinforced Laminate
  - FRP Fibreglass Reinforced Plastic
  - PVV Protective Vinyl Wallcovering
  - RHIS Rigid High Impact Sheet
  - WSSP Wetwall Solid Surface Panel
  - WVV Wetroom Vinyl Wallcovering
- FLOOR FINISHES LEGEND:**
- CFS Concrete Floor Sealer
  - EFC Epoxy Floor Coating
  - PFC Polyurethane Floor Coating
  - RAF Rubber Athletic Flooring
  - RSF Rubber Sheet Flooring
  - SCF Seamless Cushioned Flooring
  - SDRF Static-Dissipative Rubber Sheet Flooring
  - SDVF Static-Dissipative Vinyl Sheet Flooring
  - VSF Vinyl Sheet Flooring
  - WSVF Wetroom Safety Vinyl Sheet Flooring
- FLOOR BASE LEGEND:**
- FCB Flash Cove Base
  - RB Rubber Base
  - SCF Seamless Cushioned Flooring

**DOORS**

Types:

Type	Qty	Size (mm)	Material	Finish	Side Lt.	Blinds	Protect.	Privacy Film	Function	Card Reader	Mag Lock	Auto Opener	Hold Open	Hinges	Accessory 1	Accessory 2	Accessory 3	Closer
A	1	915 x 2135	Solid Core	FRL	<input type="checkbox"/>	<input type="checkbox"/>	1 Low	<input type="checkbox"/>	Other Deadbolt	<input checked="" type="checkbox"/>	<input type="checkbox"/>	<input type="checkbox"/>	<input type="checkbox"/>	Butt Hinge				Surface

Door Remarks:  Security Grille  Anti-barricade strategy

Comply with Appendix 1T [UBC FoM Design Guidelines and Functional Requirements].

**MILLWORK AND SPECIALTY CASEWORK**

Storage Requirements:  Provided purse lockers sized to accommodate a laptop.

**UPPER UNITS** (U1-U8) **SHELF** (S1)

**LOWER UNITS** (L1-L12) **RECEPTION/TRANSACTION COUNTER / CARE TEAM STATION DESK** (TC1-TC2) **UTILITY SINK AND COUNTER UNIT** (UC1)

**FULL-HEIGHT CABINETS** (C1-C5)

**Legend:**  
 Category 0 - None  
 Category 1 - Low (1% - 4%)  
 Category 2 - Med (5% - 9%)  
 Category 3 - High (10% or Greater)

Category	Min. Length (mm)	Motorized Adjustable Height	Standing Height	Specialty Casework
1	450	<input type="checkbox"/>	<input type="checkbox"/>	<input type="checkbox"/>

**FINISHES**

Full-height Cabinet:   
 Upper Millwork:   
 Countertop:   
 Lower Millwork:   
 Shelf:

Remarks:  Provide a full height mirror.

**MECHANICAL REQUIREMENTS**

**PLUMBING** (Quantity)

Hygiene Sink:	Lavatory:	Kitchen Sink:	Seamless Kitchen Sink:	Utility / Process Sink:	Scrub Sink:	Floor Sink:
<input type="text"/>	<input type="text"/>	<input type="text"/>	<input type="text"/>	<input type="text"/>	<input type="text"/>	<input type="text"/>

Plumbing Remarks:

**Other Fixtures:**

- Shower
- Tub
- Ice Maker
- Water Closet
- Instantaneous Hot Water
- Eyewash Station
- Eyewash/Shower Station
- Emergency Shower
- Flush Rim Sink
- Floor Drain
- Water Bottle Refill Station

Other:

**MED / NON-MED GASES** (Quantity)

Oxygen:	Medical Air:	Medical Vacuum:	Nitrous Oxide:	CO2:	AGSS:	Nitrogen:	Laboratory Air:	Laboratory Vacuum:	Utility Compressed Air:
<input type="text"/>	<input type="text"/>	<input type="text"/>	<input type="text"/>	<input type="text"/>	<input type="text"/>	<input type="text"/>	<input type="text"/>	<input type="text"/>	<input type="text"/>

Gas Remarks:

**Appendix 1B Minimum Room Requirements**

Room Name:

Program Number(s):

1. Y1.01	7.	13.	19.	25.	31.	37.	43.
2.	8.	14.	20.	26.	32.	38.	44.
3.	9.	15.	21.	27.	33.	39.	45.
4.	10.	16.	22.	28.	34.	40.	46.
5.	11.	17.	23.	29.	35.	41.	47.
6.	12.	18.	24.	30.	36.	42.	48.

**ARCHITECTURAL REQUIREMENTS**

<b>WALL AND CEILING</b> Wall Material: <input type="text" value="GB"/> Finish: <input type="text" value="PT"/> Ceiling Material: <input type="text" value="ACT"/> Finish: <input type="text" value="PF"/>	<b>WALL PROTECTION</b> Type: <input type="text" value="PVW"/> <input checked="" type="checkbox"/> Corner Guards <input type="checkbox"/> Hand Rails <input type="checkbox"/> Bed Bumper / Locator Height: <input type="text" value="1350 mm"/> <input type="checkbox"/> Crash Rails <input type="checkbox"/> Chair Rail	<b>GLAZING</b> <input checked="" type="checkbox"/> Interior Glazing	<b>FLOORING TYPES</b> Material: <input type="text" value="VSF"/> Base: <input type="text" value="FCB"/>	<b>ROOM ACCESSORIES</b> <input type="checkbox"/> Coat Hooks <input type="checkbox"/> Ceiling Lift <input type="checkbox"/> Magnetic Whiteboard <input type="checkbox"/> Mirror <input type="checkbox"/> Infant Change Table <input type="checkbox"/> Privacy Curtain
---	---	--	--	--

- LEGEND:**
- WALL AND CEILING LEGEND:**
- AC Architectural Ceiling
  - ACT Acoustic Ceiling Tile
  - ACT-C Cleanroom
  - ARGB Abuse-Resistant Gypsum Board
  - GB Gypsum Board
  - IRGB Impact-Resistant Gypsum Board
  - KLCT Kitchen Lay-in Ceiling Tile
  - MMRGB Moisture and Mould-Resistant Gypsum Board
  - SACT Security Acoustic Ceiling Tile
- WALL FINISHES LEGEND:**
- EWC Epoxy Wall Coating
  - HPC High Performance Coating
  - PT Paint
- CEILING FINISHES LEGEND:**
- ECC Epoxy Ceiling Coating
  - HPC High Performance Coating
  - PF Prefinished
  - PT Paint
- WALL PROTECTION LEGEND:**
- ESRP Extruded Semi-Rigid PVCu Panel
  - FRL Fibre Reinforced Laminate
  - FRP Fibreglass Reinforced Plastic
  - PVW Protective Vinyl Wallcovering
  - RHIS Rigid High Impact Sheet
  - WSSP Wetwall Solid Surface Panel
  - WVV Wetroom Vinyl Wallcovering
- FLOOR FINISHES LEGEND:**
- CFS Concrete Floor Sealer
  - EFC Epoxy Floor Coating
  - PFC Polyurethane Floor Coating
  - RAF Rubber Athletic Flooring
  - RSF Rubber Sheet Flooring
  - SCF Seamless Cushioned Flooring
  - SDRF Static-Dissipative Rubber Sheet Flooring
  - SDVF Static-Dissipative Vinyl Sheet Flooring
  - VSF Vinyl Sheet Flooring
  - WSVF Wetroom Safety Vinyl Sheet Flooring
- FLOOR BASE LEGEND:**
- FCB Flash Cove Base
  - RB Rubber Base
  - SCF Seamless Cushioned Flooring

**DOORS**

Types:

Type	Qty	Size (mm)	Material	Finish	Side Lt.	Blinds	Protect.	Privacy Film	Function	Card Reader	Mag Lock	Auto Opener	Hold Open	Hinges	Accessory 1	Accessory 2	Accessory 3	Closer
C	2	1220 x 2135	Hollow Metal	Paint	<input type="checkbox"/>	<input type="checkbox"/>		<input type="checkbox"/>	Storeroom	<input checked="" type="checkbox"/>	<input type="checkbox"/>	<input checked="" type="checkbox"/>	<input type="checkbox"/>	Butt Hinge	Elec. Strike			Surface

Door Remarks:  Security Grille  Anti-barricade strategy

**MILLWORK AND SPECIALTY CASEWORK**

**UPPER UNITS** (U1-U8) **LOWER UNITS** (L1-L12) **SHELF** (S1) **RECEPTION/TRANSACTION COUNTER / CARE TEAM STATION DESK** (TC1, TC2) **UTILITY SINK AND COUNTER UNIT** (UC1)

Storage Requirements:

**FINISHES**

Full-height Cabinet:   
 Upper Millwork:   
 Countertop:   
 Lower Millwork:   
 Shelf:

Remarks:

**Legend:**

Category	Min. Length (mm)	Motorized Adjustable Height	Standing Height	Specialty Casework
Category 0 - None		<input type="checkbox"/>	<input type="checkbox"/>	<input type="checkbox"/>
Category 1 - Low (1% - 4%)		<input type="checkbox"/>	<input type="checkbox"/>	<input type="checkbox"/>
Category 2 - Med (5% - 9%)		<input type="checkbox"/>	<input type="checkbox"/>	<input type="checkbox"/>
Category 3 - High (10% or Greater)		<input type="checkbox"/>	<input type="checkbox"/>	<input type="checkbox"/>

**MECHANICAL REQUIREMENTS**

<b>PLUMBING</b> (Quantity) Hand Hygiene Sink: <input type="text" value="1"/> Lavatory: <input type="text"/> Kitchen Sink: <input type="text"/> Seamless Kitchen Sink: <input type="text"/> Utility / Process Sink: <input type="text"/> Scrub Sink: <input type="text"/> Floor Sink: <input type="text"/> Plumbing Remarks: <input type="text"/>	Other Fixtures: <input type="checkbox"/> Shower <input type="checkbox"/> Tub <input type="checkbox"/> Ice Maker <input type="checkbox"/> Water Closet <input type="checkbox"/> Instantaneous Hot Water <input type="checkbox"/> Eyewash Station <input type="checkbox"/> Eyewash/Shower Station <input type="checkbox"/> Emergency Shower <input type="checkbox"/> Flush Rim Sink <input type="checkbox"/> Floor Drain <input type="checkbox"/> Water Bottle Refill Station Other: <input type="text"/>	<b>MED / NON-MED GASES</b> (Quantity) Oxygen: <input type="text"/> Medical Air: <input type="text"/> Medical Vacuum: <input type="text"/> Nitrous Oxide: <input type="text"/> CO2: <input type="text"/> AGSS: <input type="text"/> Nitrogen: <input type="text"/> Laboratory Air: <input type="text"/> Laboratory Vacuum: <input type="text"/> Utility Compressed Air: <input type="text"/> Gas Remarks: <input type="text"/>
--	--	---



**Appendix 1B Minimum Room Requirements**

Room Name:

Program Number(s):

1. Y2.01	7.	13.	19.	25.	31.	37.	43.
2.	8.	14.	20.	26.	32.	38.	44.
3.	9.	15.	21.	27.	33.	39.	45.
4.	10.	16.	22.	28.	34.	40.	46.
5.	11.	17.	23.	29.	35.	41.	47.
6.	12.	18.	24.	30.	36.	42.	48.

**ARCHITECTURAL REQUIREMENTS**

<b>WALL AND CEILING</b> Wall Material: <input type="text" value="ARGB 1.2m AFF, GB above"/> Finish: <input type="text" value="PT"/> Ceiling Material: <input type="text" value="ACT"/> Finish: <input type="text" value="PF"/>	<b>WALL PROTECTION</b> Type: <input type="text" value="PVW"/> <input checked="" type="checkbox"/> Corner Guards <input type="checkbox"/> Hand Rails <input type="checkbox"/> Bed Bumper / Locator Height: <input type="text" value="1350 mm"/> <input type="checkbox"/> Crash Rails <input checked="" type="checkbox"/> Chair Rail	<b>GLAZING</b> <input type="checkbox"/> Interior Glazing	<b>FLOORING TYPES</b> Material: <input type="text" value="VSF"/> Base: <input type="text" value="FCB"/>	<b>ROOM ACCESSORIES</b> <input checked="" type="checkbox"/> Coat Hooks <input type="checkbox"/> Ceiling Lift <input checked="" type="checkbox"/> Magnetic Whiteboard <input type="checkbox"/> Mirror <input type="checkbox"/> Infant Change Table <input type="checkbox"/> Privacy Curtain
--	--	---	--	--

- LEGEND:**
- WALL AND CEILING LEGEND:**
- AC Architectural Ceiling
  - ACT Acoustic Ceiling Tile
  - ACT-C Cleanroom
  - ARGB Abuse-Resistant Gypsum Board
  - GB Gypsum Board
  - IRGB Impact-Resistant Gypsum Board
  - KLCT Kitchen Lay-in Ceiling Tile
  - MMRGB Moisture and Mould-Resistant Gypsum Board
  - SACT Security Acoustic Ceiling Tile
- WALL FINISHES LEGEND:**
- EWC Epoxy Wall Coating
  - HPC High Performance Coating
  - PT Paint
- CEILING FINISHES LEGEND:**
- ECC Epoxy Ceiling Coating
  - HPC High Performance Coating
  - PF Prefinished
  - PT Paint
- WALL PROTECTION LEGEND:**
- ESRP Extruded Semi-Rigid PVCu Panel
  - FRL Fibre Reinforced Laminate
  - FRP Fibreglass Reinforced Plastic
  - PVW Protective Vinyl Wallcovering
  - RHIS Rigid High Impact Sheet
  - WSSP Wetwall Solid Surface Panel
  - WVV Wetroom Vinyl Wallcovering
- FLOOR FINISHES LEGEND:**
- CFS Concrete Floor Sealer
  - EFC Epoxy Floor Coating
  - PFC Polyurethane Floor Coating
  - RAF Rubber Athletic Flooring
  - RSF Rubber Sheet Flooring
  - SCF Seamless Cushioned Flooring
  - SDRF Static-Dissipative Rubber Sheet Flooring
  - SDVF Static-Dissipative Vinyl Sheet Flooring
  - VSF Vinyl Sheet Flooring
  - WSVF Wetroom Safety Vinyl Sheet Flooring
- FLOOR BASE LEGEND:**
- FCB Flash Cove Base
  - RB Rubber Base
  - SCF Seamless Cushioned Flooring

**DOORS**

Types:

Type	Qty	Size (mm)	Material	Finish	Side Lt.	Blinds	Protect.	Privacy Film	Function	Card Reader	Mag Lock	Auto Opener	Hold Open	Hinges	Accessory 1	Accessory 2	Accessory 3	Closer
B	1	915 x 2135	Solid Core	FRL	<input type="checkbox"/>	<input type="checkbox"/>	2 High	<input checked="" type="checkbox"/>	Storeroom	<input checked="" type="checkbox"/>	<input type="checkbox"/>	<input type="checkbox"/>	<input type="checkbox"/>	Butt Hinge				Surface

Door Remarks:  Security Grille  Anti-barricade strategy

**MILLWORK AND SPECIALTY CASEWORK**

**UPPER UNITS** (U1-U8) **LOWER UNITS** (L1-L12) **RECEPTION/TRANSACTION COUNTER / CARE TEAM STATION DESK** (TC1-TC2) **UTILITY SINK AND COUNTER UNIT** (UC1)

Storage Requirements:

**FINISHES**

Full-height Cabinet:

Upper Millwork:

Countertop:

Lower Millwork:

Shelf:

Remarks:

Category	Min. Length (mm)	Motorized Adjustable Height	Standing Height	Specialty Casework
2	3600	<input checked="" type="checkbox"/>	<input checked="" type="checkbox"/>	<input type="checkbox"/>

**MECHANICAL REQUIREMENTS**

<b>PLUMBING</b> (Quantity) Hand Hygiene Sink: <input type="text" value="1"/> Lavatory: <input type="text"/> Kitchen Sink: <input type="text" value="1"/> Seamless Kitchen Sink: <input type="text"/> Utility / Process Sink: <input type="text"/> Scrub Sink: <input type="text"/> Floor Sink: <input type="text"/> Plumbing Remarks: <input type="text"/>	Other Fixtures: <input type="checkbox"/> Shower <input type="checkbox"/> Tub <input type="checkbox"/> Ice Maker <input type="checkbox"/> Water Closet <input checked="" type="checkbox"/> Instantaneous Hot Water <input type="checkbox"/> Ewwash Station <input type="checkbox"/> Eyewash/Shower Station <input type="checkbox"/> Emergency Shower <input type="checkbox"/> Flush Rim Sink <input type="checkbox"/> Floor Drain <input checked="" type="checkbox"/> Water Bottle Refill Station Other: <input type="text"/>	<b>MED / NON-MED GASES</b> (Quantity) Oxygen: <input type="text"/> Medical Air: <input type="text"/> Medical Vacuum: <input type="text"/> Nitrous Oxide: <input type="text"/> CO2: <input type="text"/> AGSS: <input type="text"/> Nitrogen: <input type="text"/> Laboratory Air: <input type="text"/> Laboratory Vacuum: <input type="text"/> Utility Compressed Air: <input type="text"/> Gas Remarks: <input type="text"/>
---	---	---

---

# New Surrey Hospital & BC Cancer Centre

MINIMUM ROOM REQUIREMENTS

## Z. Recurring Rooms

---

**Appendix 1B Minimum Room Requirements**

Room Name:

Program Number(s):

1. A4.10	7. D3.06	13. L2.11	19.	25.	31.	37.	43.
2. B1.22	8. D6.16	14. M2.20	20.	26.	32.	38.	44.
3. B2.30	9. F7.03	15.	21.	27.	33.	39.	45.
4. C3.34	10. G1.19	16.	22.	28.	34.	40.	46.
5. C4.28	11. I2.14	17.	23.	29.	35.	41.	47.
6. D2.22	12. L1.21	18.	24.	30.	36.	42.	48.

**ARCHITECTURAL REQUIREMENTS**

<b>WALL AND CEILING</b> Wall Material: <input type="text" value="ARGB 1.2m AFF, GB above"/> Finish: <input type="text" value="PT"/> Ceiling Material: <input type="text" value="ACT"/> Finish: <input type="text" value="PF"/>		<b>WALL PROTECTION</b> Type: <input type="text" value="PVW"/> <input checked="" type="checkbox"/> Corner Guards <input type="checkbox"/> Hand Rails <input type="checkbox"/> Bed Bumper / Locator Height: <input type="text" value="2185 mm"/> <input type="checkbox"/> Crash Rails <input type="checkbox"/> Chair Rail		<b>GLAZING</b> <input type="checkbox"/> Interior Glazing		<b>FLOORING TYPES</b> Material: <input type="text" value="VSF"/> Base: <input type="text" value="FCB"/>		<b>ROOM ACCESSORIES</b> <input type="checkbox"/> Coat Hooks <input type="checkbox"/> Ceiling Lift <input type="checkbox"/> Magnetic Whiteboard <input type="checkbox"/> Mirror <input type="checkbox"/> Infant Change Table <input type="checkbox"/> Privacy Curtain	
--	--	---	--	---	--	--	--	--	--

- LEGEND:**
- WALL AND CEILING LEGEND:**
- AC Architectural Ceiling
  - ACT Acoustic Ceiling Tile
  - ACT-C Cleanroom
  - ARGB Abuse-Resistant Gypsum Board
  - GB Gypsum Board
  - IRGB Impact-Resistant Gypsum Board
  - KLCT Kitchen Lay-in Ceiling Tile
  - MMRGB Moisture and Mould-Resistant Gypsum Board
  - SACT Security Acoustic Ceiling Tile
- WALL FINISHES LEGEND:**
- EWC Epoxy Wall Coating
  - HPC High Performance Coating
  - PT Paint
- CEILING FINISHES LEGEND:**
- ECC Epoxy Ceiling Coating
  - HPC High Performance Coating
  - PF Prefinished
  - PT Paint
- WALL PROTECTION LEGEND:**
- ESRP Extruded Semi-Rigid PVCu Panel
  - FRL Fibre Reinforced Laminate
  - FRP Fibreglass Reinforced Plastic
  - PVW Protective Vinyl Wallcovering
  - RHIS Rigid High Impact Sheet
  - WSSP Wetwall Solid Surface Panel
  - WVV Wetroom Vinyl Wallcovering
- FLOOR FINISHES LEGEND:**
- CFS Concrete Floor Sealer
  - EFC Epoxy Floor Coating
  - PFC Polyurethane Floor Coating
  - RAF Rubber Athletic Flooring
  - RSF Rubber Sheet Flooring
  - SCF Seamless Cushioned Flooring
  - SDRF Static-Dissipative Rubber Sheet Flooring
  - SDVF Static-Dissipative Vinyl Sheet Flooring
  - VSF Vinyl Sheet Flooring
  - WSVF Wetroom Safety Vinyl Sheet Flooring
- FLOOR BASE LEGEND:**
- FCB Flash Cove Base
  - RB Rubber Base
  - SCF Seamless Cushioned Flooring

**DOORS**

Types:

Type:Qty:	Size (mm):	Material:	Finish:	Side Lt:	Blinds:	Protect.:	Privacy Film:	Function:	Card Reader:	Mag Lock:	Auto Opener:	Hold Open:	Hinges:	Accessory 1:	Accessory 2:	Accessory 3:	Closer:

Door Remarks:  Security Grille  Anti-barricade strategy

**MILLWORK AND SPECIALTY CASEWORK**

**UPPER UNITS** (U1-U8) **LOWER UNITS** (L1-L12) **RECEPTION/TRANSACTION COUNTER / CARE TEAM STATION DESK** (TC1-TC2) **UTILITY SINK AND COUNTER UNIT** (UC1)

Storage Requirements:

**FINISHES**

Full-height Cabinet:   
 Upper Millwork:   
 Countertop:   
 Lower Millwork:   
 Shelf:

Remarks:

**Legend:**

Category	Min. Length (mm)	Motorized Adjustable Height	Standing Height	Specialty Casework
Category 0 - None				
Category 1 - Low (1% - 4%)				
Category 2 - Med (5% - 9%)				
Category 3 - High (10% or Greater)				

**MECHANICAL REQUIREMENTS**

<b>PLUMBING</b> (Quantity) Hand Hygiene Sink: <input type="text"/> Lavatory: <input type="text"/> Kitchen Sink: <input type="text"/> Seamless Kitchen Sink: <input type="text"/> Utility / Process Sink: <input type="text"/> Scrub Sink: <input type="text"/> Floor Sink: <input type="text"/>		Other Fixtures: <input type="checkbox"/> Shower <input type="checkbox"/> Eyewash Station <input type="checkbox"/> Tub <input type="checkbox"/> Eyewash/Shower Station <input type="checkbox"/> Ice Maker <input type="checkbox"/> Emergency Shower <input type="checkbox"/> Water Closet <input type="checkbox"/> Flush Rim Sink <input type="checkbox"/> Instantaneous Hot Water <input type="checkbox"/> Floor Drain <input type="checkbox"/> Water Bottle Refill Station Other: <input type="text"/>		<b>MED / NON-MED GASES</b> (Quantity) Oxygen: <input type="text"/> Medical Air: <input type="text"/> Medical Vacuum: <input type="text"/> Nitrous Oxide: <input type="text"/> CO2: <input type="text"/> AGSS: <input type="text"/> Nitrogen: <input type="text"/> Laboratory Air: <input type="text"/> Laboratory Vacuum: <input type="text"/> Utility Compressed Air: <input type="text"/>	
Plumbing Remarks: <input type="text"/>		Gas Remarks: <input type="text"/>			



**Appendix 1B Minimum Room Requirements**

Room Name:

Program Number(s):

1. A4.09	7. D2.23	13. F5.03	19. M2.19	25.	31.	37.	43.
2. B1.08	8. D3.07	14. F6.03	20. N1.05	26.	32.	38.	44.
3. B2.09	9. D6.17	15. G1.11	21. P4.05	27.	33.	39.	45.
4. B3.07	10. F2.06	16. I2.13	22. X2.01.8	28.	34.	40.	46.
5. C3.20	11. F3.03	17. K3.04	23.	29.	35.	41.	47.
6. C4.16	12. F4.03	18. K4.05	24.	30.	36.	42.	48.

**ARCHITECTURAL REQUIREMENTS**

<b>WALL AND CEILING</b> Wall Material: <input type="text" value="ARGB 1.2m AFF, GB above"/> Finish: <input type="text" value="PT"/> Ceiling Material: <input type="text" value="ACT"/> Finish: <input type="text" value="PF"/>		<b>WALL PROTECTION</b> Type: <input type="text" value="PVW"/> <input checked="" type="checkbox"/> Corner Guards <input type="checkbox"/> Hand Rails <input type="checkbox"/> Bed Bumper / Locator Height: <input type="text" value="2185 mm"/> <input checked="" type="checkbox"/> Crash Rails <input type="checkbox"/> Chair Rail		<b>GLAZING</b> <input type="checkbox"/> Interior Glazing		<b>FLOORING TYPES</b> Material: <input type="text" value="VSF"/> Base: <input type="text" value="FCB"/>		<b>ROOM ACCESSORIES</b> <input type="checkbox"/> Coat Hooks <input type="checkbox"/> Ceiling Lift <input type="checkbox"/> Magnetic Whiteboard <input type="checkbox"/> Mirror <input type="checkbox"/> Infant Change Table <input type="checkbox"/> Privacy Curtain	
--	--	--	--	---	--	--	--	--	--

- LEGEND:**
- WALL AND CEILING LEGEND:**
- AC Architectural Ceiling
  - ACT Acoustic Ceiling Tile
  - ACT-C Cleanroom
  - ARGB Abuse-Resistant Gypsum Board
  - GB Gypsum Board
  - IRGB Impact-Resistant Gypsum Board
  - KLCT Kitchen Lay-in Ceiling Tile
  - MMRGB Moisture and Mould-Resistant Gypsum Board
  - SACT Security Acoustic Ceiling Tile
- WALL FINISHES LEGEND:**
- EWC Epoxy Wall Coating
  - HPC High Performance Coating
  - PT Paint
- CEILING FINISHES LEGEND:**
- ECC Epoxy Ceiling Coating
  - HPC High Performance Coating
  - PF Prefinished
  - PT Paint
- WALL PROTECTION LEGEND:**
- ESRP Extruded Semi-Rigid PVCu Panel
  - FRL Fibre Reinforced Laminate
  - FRP Fibreglass Reinforced Plastic
  - PVW Protective Vinyl Wallcovering
  - RHIS Rigid High Impact Sheet
  - WSSP Wetwall Solid Surface Panel
  - WVV Wetroom Vinyl Wallcovering
- FLOOR FINISHES LEGEND:**
- CFS Concrete Floor Sealer
  - EFC Epoxy Floor Coating
  - PFC Polyurethane Floor Coating
  - RAF Rubber Athletic Flooring
  - RSF Rubber Sheet Flooring
  - SCF Seamless Cushioned Flooring
  - SDRF Static-Dissipative Rubber Sheet Flooring
  - SDVF Static-Dissipative Vinyl Sheet Flooring
  - VSF Vinyl Sheet Flooring
  - WSVF Wetroom Safety Vinyl Sheet Flooring
- FLOOR BASE LEGEND:**
- FCB Flash Cove Base
  - RB Rubber Base
  - SCF Seamless Cushioned Flooring

**DOORS**

Types:

Type	Qty	Size (mm)	Material	Finish	Side Lt	Blinds	Protect	Privacy Film	Function	Card Reader	Mag Lock	Auto Opener	Hold Open	Hinges	Accessory 1	Accessory 2	Accessory 3	Closer	

Door Remarks:  Security Grille  Anti-barricade strategy

**MILLWORK AND SPECIALTY CASEWORK**

**UPPER UNITS** (U1-U8) **LOWER UNITS** (L1-L12) **RECEPTION/TRANSACTION COUNTER / CARE TEAM STATION DESK** (TC1-TC2) **UTILITY SINK AND COUNTER UNIT** (UC1)

Storage Requirements:

**FINISHES**

Full-height Cabinet:   
 Upper Millwork:   
 Countertop:   
 Lower Millwork:   
 Shelf:

Remarks:

**Legend:**

Category	Min. Length (mm)	Motorized Adjustable Height	Standing Height	Specialty Casework
Category 0 - None				
Category 1 - Low (1% - 4%)				
Category 2 - Med (5% - 9%)				
Category 3 - High (10% or Greater)				

**MECHANICAL REQUIREMENTS**

<b>PLUMBING</b> (Quantity) Hand Hygiene Sink: <input type="text"/> Lavatory: <input type="text"/> Kitchen Sink: <input type="text"/> Seamless Kitchen Sink: <input type="text"/> Utility / Process Sink: <input type="text"/> Scrub Sink: <input type="text"/> Floor Sink: <input type="text"/> Plumbing Remarks: <input type="text"/>		Other Fixtures: <input type="checkbox"/> Shower <input type="checkbox"/> Tub <input type="checkbox"/> Ice Maker <input type="checkbox"/> Water Closet <input type="checkbox"/> Instantaneous Hot Water <input type="checkbox"/> Eyewash Station <input type="checkbox"/> Eyewash/Shower Station <input type="checkbox"/> Emergency Shower <input type="checkbox"/> Flush Rim Sink <input type="checkbox"/> Floor Drain <input type="checkbox"/> Water Bottle Refill Station Other: <input type="text"/>		<b>MED / NON-MED GASES</b> (Quantity) Oxygen: <input type="text"/> Medical Air: <input type="text"/> Medical Vacuum: <input type="text"/> Nitrous Oxide: <input type="text"/> CO2: <input type="text"/> AGSS: <input type="text"/> Nitrogen: <input type="text"/> Laboratory Air: <input type="text"/> Laboratory Vacuum: <input type="text"/> Utility Compressed Air: <input type="text"/> Gas Remarks: <input type="text"/>	
--	--	--	--	---	--

**Appendix 1B Minimum Room Requirements**

Room Name:

Program Number(s):

1. B3.08	7.	13.	19.	25.	31.	37.	43.
2. C4.17	8.	14.	20.	26.	32.	38.	44.
3. C5.09	9.	15.	21.	27.	33.	39.	45.
4. C7.03	10.	16.	22.	28.	34.	40.	46.
5. C3.21	11.	17.	23.	29.	35.	41.	47.
6.	12.	18.	24.	30.	36.	42.	48.

**ARCHITECTURAL REQUIREMENTS**

<b>WALL AND CEILING</b> Wall Material: <input type="text" value="ARGB 1.2m AFF, GB above"/> Finish: <input type="text" value="PT"/> Ceiling Material: <input type="text" value="ACT"/> Finish: <input type="text" value="PF"/>		<b>WALL PROTECTION</b> Type: <input type="text" value="PVW"/> <input checked="" type="checkbox"/> Corner Guards <input type="checkbox"/> Hand Rails <input type="checkbox"/> Bed Bumper / Locator Height: <input type="text" value="2185 mm"/> <input checked="" type="checkbox"/> Crash Rails <input type="checkbox"/> Chair Rail		<b>GLAZING</b> <input type="checkbox"/> Interior Glazing		<b>FLOORING TYPES</b> Material: <input type="text" value="VSF"/> Base: <input type="text" value="FCB"/>		<b>ROOM ACCESSORIES</b> <input type="checkbox"/> Coat Hooks <input type="checkbox"/> Ceiling Lift <input type="checkbox"/> Magnetic Whiteboard <input type="checkbox"/> Mirror <input type="checkbox"/> Infant Change Table <input type="checkbox"/> Privacy Curtain	
--	--	--	--	---	--	--	--	--	--

- LEGEND:**
- WALL AND CEILING LEGEND:**
- AC Architectural Ceiling
  - ACT Acoustic Ceiling Tile
  - ACT-C Cleanroom
  - ARGB Abuse-Resistant Gypsum Board
  - GB Gypsum Board
  - IRGB Impact-Resistant Gypsum Board
  - KLCT Kitchen Lay-in Ceiling Tile
  - MMRGB Moisture and Mould-Resistant Gypsum Board
  - SACT Security Acoustic Ceiling Tile
- WALL FINISHES LEGEND:**
- EWC Epoxy Wall Coating
  - HPC High Performance Coating
  - PT Paint
- CEILING FINISHES LEGEND:**
- ECC Epoxy Ceiling Coating
  - HPC High Performance Coating
  - PF Prefinished
  - PT Paint
- WALL PROTECTION LEGEND:**
- ESRP Extruded Semi-Rigid PVCu Panel
  - FRL Fibre Reinforced Laminate
  - FRP Fibreglass Reinforced Plastic
  - PVW Protective Vinyl Wallcovering
  - RHIS Rigid High Impact Sheet
  - WSSP Wetwall Solid Surface Panel
  - WVV Wetroom Vinyl Wallcovering
- FLOOR FINISHES LEGEND:**
- CFS Concrete Floor Sealer
  - EFC Epoxy Floor Coating
  - PFC Polyurethane Floor Coating
  - RAF Rubber Athletic Flooring
  - RSF Rubber Sheet Flooring
  - SCF Seamless Cushioned Flooring
  - SDRF Static-Dissipative Rubber Sheet Flooring
  - SDVF Static-Dissipative Vinyl Sheet Flooring
  - VSF Vinyl Sheet Flooring
  - WSVF Wetroom Safety Vinyl Sheet Flooring
- FLOOR BASE LEGEND:**
- FCB Flash Cove Base
  - RB Rubber Base
  - SCF Seamless Cushioned Flooring

**DOORS**

Types:

Type	Qty	Size (mm)	Material	Finish	Side Lt	Blinds	Protect	Privacy Film	Function	Card Reader	Mag Lock	Auto Opener	Hold Open	Hinges	Accessory 1	Accessory 2	Accessory 3	Closer	

Door Remarks:  Security Grille  Anti-barricade strategy

**MILLWORK AND SPECIALTY CASEWORK**

**UPPER UNITS** (U1-U8) **LOWER UNITS** (L1-L12) **RECEPTION/TRANSACTION COUNTER / CARE TEAM STATION DESK** (TC1-TC2) **UTILITY SINK AND COUNTER UNIT** (UC1)

Storage Requirements:

**FINISHES**

Full-height Cabinet:   
 Upper Millwork:   
 Countertop:   
 Lower Millwork:   
 Shelf:

Remarks:

**Legend:**

Category	Min. Length (mm)	Motorized Adjustable Height	Standing Height	Specialty Casework
Category 0 - None				
Category 1 - Low (1% - 4%)				
Category 2 - Med (5% - 9%)				
Category 3 - High (10% or Greater)				

**MECHANICAL REQUIREMENTS**

<b>PLUMBING</b> (Quantity) Hygiene Sink: <input type="text"/> Lavatory: <input type="text"/> Kitchen Sink: <input type="text"/> Seamless Kitchen Sink: <input type="text"/> Utility / Process Sink: <input type="text"/> Scrub Sink: <input type="text"/> Floor Sink: <input type="text"/>							Other Fixtures: <input type="checkbox"/> Shower <input type="checkbox"/> Eyewash Station <input type="checkbox"/> Tub <input type="checkbox"/> Eyewash/Shower Station <input type="checkbox"/> Ice Maker <input type="checkbox"/> Emergency Shower <input type="checkbox"/> Water Closet <input type="checkbox"/> Flush Rim Sink <input type="checkbox"/> Instantaneous Hot Water <input type="checkbox"/> Floor Drain <input type="checkbox"/> Water Bottle Refill Station Other: <input type="text"/>				<b>MED / NON-MED GASES</b> (Quantity) Oxygen: <input type="text"/> Medical Air: <input type="text"/> Medical Vacuum: <input type="text"/> Nitrous Oxide: <input type="text"/> CO2: <input type="text"/> AGSS: <input type="text"/> Nitrogen: <input type="text"/> Laboratory Air: <input type="text"/> Laboratory Vacuum: <input type="text"/> Utility Compressed Air: <input type="text"/>					
Plumbing Remarks: <input type="text"/>											Gas Remarks: <input type="text"/>					

**Appendix 1B Minimum Room Requirements**

Room Name:

Program Number(s):

1. A4.08	7. F4.16	13.	19.	25.	31.	37.	43.
2. B1.17	8. F5.06	14.	20.	26.	32.	38.	44.
3. B2.21	9. G1.17	15.	21.	27.	33.	39.	45.
4. B3.20	10. I2.15	16.	22.	28.	34.	40.	46.
5. C3.27	11. L1.14	17.	23.	29.	35.	41.	47.
6. C4.23	12. L2.12	18.	24.	30.	36.	42.	48.

**ARCHITECTURAL REQUIREMENTS**

<b>WALL AND CEILING</b> Wall Material: <input type="text" value="ARGB 1.2m AFF, GB above"/> Finish: <input type="text" value="PT"/> Ceiling Material: <input type="text" value="ACT"/> Finish: <input type="text" value="PF"/>		<b>WALL PROTECTION</b> Type: <input type="text" value="PVW"/> <input checked="" type="checkbox"/> Corner Guards <input type="checkbox"/> Hand Rails <input type="checkbox"/> Bed Bumper / Locator Height: <input type="text" value="2185 mm"/> <input checked="" type="checkbox"/> Crash Rails <input type="checkbox"/> Chair Rail		<b>GLAZING</b> <input type="checkbox"/> Interior Glazing		<b>FLOORING TYPES</b> Material: <input type="text" value="VSF"/> Base: <input type="text" value="FCB"/>		<b>ROOM ACCESSORIES</b> <input type="checkbox"/> Coat Hooks <input type="checkbox"/> Ceiling Lift <input checked="" type="checkbox"/> Magnetic Whiteboard <input type="checkbox"/> Mirror <input type="checkbox"/> Infant Change Table <input type="checkbox"/> Privacy Curtain	
--	--	--	--	---	--	--	--	---	--

- LEGEND:**
- WALL AND CEILING LEGEND:**
- AC Architectural Ceiling
  - ACT Acoustic Ceiling Tile
  - ACT-C Cleanroom
  - ARGB Abuse-Resistant Gypsum Board
  - GB Gypsum Board
  - IRGB Impact-Resistant Gypsum Board
  - KLCT Kitchen Lay-in Ceiling Tile
  - MMRGB Moisture and Mould-Resistant Gypsum Board
  - SACT Security Acoustic Ceiling Tile
- WALL FINISHES LEGEND:**
- EWC Epoxy Wall Coating
  - HPC High Performance Coating
  - PT Paint
- CEILING FINISHES LEGEND:**
- ECC Epoxy Ceiling Coating
  - HPC High Performance Coating
  - PF Prefinished
  - PT Paint
- WALL PROTECTION LEGEND:**
- ESRP Extruded Semi-Rigid PVCu Panel
  - FRL Fibre Reinforced Laminate
  - FRP Fibreglass Reinforced Plastic
  - PVW Protective Vinyl Wallcovering
  - RHIS Rigid High Impact Sheet
  - WSSP Wetwall Solid Surface Panel
  - WVV Wetroom Vinyl Wallcovering
- FLOOR FINISHES LEGEND:**
- CFS Concrete Floor Sealer
  - EFC Epoxy Floor Coating
  - PFC Polyurethane Floor Coating
  - RAF Rubber Athletic Flooring
  - RSF Rubber Sheet Flooring
  - SCF Seamless Cushioned Flooring
  - SDRF Static-Dissipative Rubber Sheet Flooring
  - SDVF Static-Dissipative Vinyl Sheet Flooring
  - VSF Vinyl Sheet Flooring
  - WSVF Wetroom Safety Vinyl Sheet Flooring
- FLOOR BASE LEGEND:**
- FCB Flash Cove Base
  - RB Rubber Base
  - SCF Seamless Cushioned Flooring

**DOORS**

Types:

Type:Qty:	Size (mm):	Material:	Finish:	Side Lt:	Blinds:	Protect.:	Privacy Film:	Function:	Card Reader:	Mag Lock:	Auto Opener:	Hold Open:	Hinges:	Accessory 1:	Accessory 2:	Accessory 3:	Closer:

Door Remarks:  Security Grille  Anti-barricade strategy

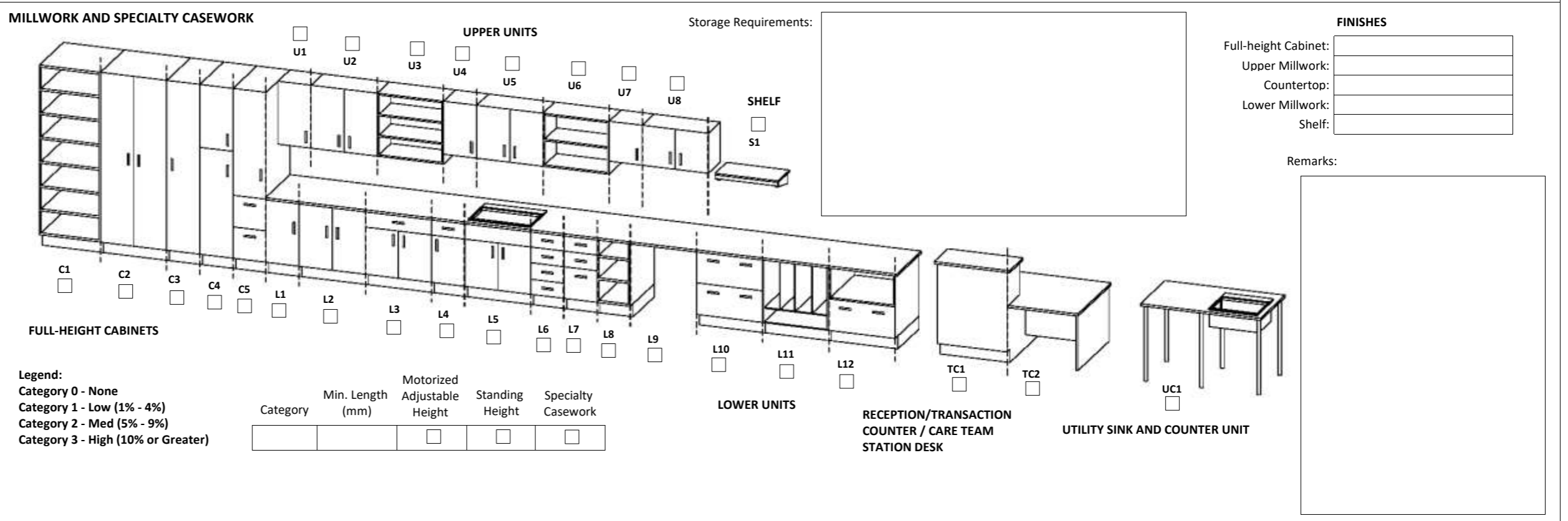

**MECHANICAL REQUIREMENTS**

<b>PLUMBING</b> (Quantity) Hand Hygiene Sink: <input type="text"/> Lavatory: <input type="text"/> Kitchen Sink: <input type="text"/> Seamless Kitchen Sink: <input type="text"/> Utility / Process Sink: <input type="text"/> Scrub Sink: <input type="text"/> Floor Sink: <input type="text"/> Plumbing Remarks: <input type="text"/>		Other Fixtures: <input type="checkbox"/> Shower <input type="checkbox"/> Eyewash Station <input type="checkbox"/> Tub <input type="checkbox"/> Eyewash/Shower Station <input type="checkbox"/> Ice Maker <input type="checkbox"/> Emergency Shower <input type="checkbox"/> Water Closet <input type="checkbox"/> Flush Rim Sink <input type="checkbox"/> Instantaneous Hot Water <input type="checkbox"/> Floor Drain <input type="checkbox"/> Water Bottle Refill Station Other: <input type="text"/>		<b>MED / NON-MED GASES</b> (Quantity) Oxygen: <input type="text"/> Medical Air: <input type="text"/> Medical Vacuum: <input type="text"/> Nitrous Oxide: <input type="text"/> CO2: <input type="text"/> AGSS: <input type="text"/> Nitrogen: <input type="text"/> Laboratory Air: <input type="text"/> Laboratory Vacuum: <input type="text"/> Utility Compressed Air: <input type="text"/> Gas Remarks: <input type="text"/>	
--	--	--	--	--	--



**Appendix 1B Minimum Room Requirements**

Room Name:

Program Number(s):

1. C3.29	7.	13.	19.	25.	31.	37.	43.
2. E2.01.05	8.	14.	20.	26.	32.	38.	44.
3. E3.01.13	9.	15.	21.	27.	33.	39.	45.
4. K3.15	10.	16.	22.	28.	34.	40.	46.
5.	11.	17.	23.	29.	35.	41.	47.
6.	12.	18.	24.	30.	36.	42.	48.

**ARCHITECTURAL REQUIREMENTS**

<b>WALL AND CEILING</b> Wall Material: <input type="text" value="ARGB 1.2m AFF, GB above"/> Finish: <input type="text" value="PT"/> Ceiling Material: <input type="text" value="ACT"/> Finish: <input type="text" value="PF"/>		<b>WALL PROTECTION</b> Type: <input type="text" value="WVV"/> <input checked="" type="checkbox"/> Corner Guards <input type="checkbox"/> Hand Rails <input type="checkbox"/> Bed Bumper / Locator Height: <input type="text" value="2185 mm"/> <input type="checkbox"/> Crash Rails <input type="checkbox"/> Chair Rail		<b>GLAZING</b> <input type="checkbox"/> Interior Glazing		<b>FLOORING TYPES</b> Material: <input type="text" value="WSVF"/> Base: <input type="text" value="FCB"/>		<b>ROOM ACCESSORIES</b> <input type="checkbox"/> Coat Hooks <input type="checkbox"/> Ceiling Lift <input type="checkbox"/> Magnetic Whiteboard <input type="checkbox"/> Mirror <input type="checkbox"/> Infant Change Table <input type="checkbox"/> Privacy Curtain	
--	--	---	--	---	--	---	--	--	--

- LEGEND:**
- WALL AND CEILING LEGEND:**
- AC Architectural Ceiling
  - ACT Acoustic Ceiling Tile
  - ACT-C Cleanroom
  - ARGB Abuse-Resistant Gypsum Board
  - GB Gypsum Board
  - IRGB Impact-Resistant Gypsum Board
  - KLCT Kitchen Lay-in Ceiling Tile
  - MMRGB Moisture and Mould-Resistant Gypsum Board
  - SACT Security Acoustic Ceiling Tile
- WALL FINISHES LEGEND:**
- EWC Epoxy Wall Coating
  - HPC High Performance Coating
  - PT Paint
- CEILING FINISHES LEGEND:**
- ECC Epoxy Ceiling Coating
  - HPC High Performance Coating
  - PF Prefinished
  - PT Paint
- WALL PROTECTION LEGEND:**
- ESRP Extruded Semi-Rigid PVCu Panel
  - FRL Fibre Reinforced Laminate
  - FRP Fibreglass Reinforced Plastic
  - PVV Protective Vinyl Wallcovering
  - RHIS Rigid High Impact Sheet
  - WSSP Wetwall Solid Surface Panel
  - WVV Wetroom Vinyl Wallcovering
- FLOOR FINISHES LEGEND:**
- CFS Concrete Floor Sealer
  - EFC Epoxy Floor Coating
  - PFC Polyurethane Floor Coating
  - RAF Rubber Athletic Flooring
  - RSF Rubber Sheet Flooring
  - SCF Seamless Cushioned Flooring
  - SDRF Static-Dissipative Rubber Sheet Flooring
  - SDVF Static-Dissipative Vinyl Sheet Flooring
  - VSF Vinyl Sheet Flooring
  - WSVF Wetroom Safety Vinyl Sheet Flooring
- FLOOR BASE LEGEND:**
- FCB Flash Cove Base
  - RB Rubber Base
  - SCF Seamless Cushioned Flooring

**DOORS**

Types:

Type	Qty	Size (mm)	Material	Finish	Side Lt.	Blinds	Protect.	Privacy Film	Function	Card Reader	Mag Lock	Auto Opener	Hold Open	Hinges	Accessory 1	Accessory 2	Accessory 3	Closer

Door Remarks:  Security Grille  Anti-barricade strategy

**MILLWORK AND SPECIALTY CASEWORK**

**UPPER UNITS** (U1-U8) **LOWER UNITS** (L1-L12) **RECEPTION/TRANSACTION COUNTER / CARE TEAM STATION DESK** (TC1-TC2) **UTILITY SINK AND COUNTER UNIT** (UC1)

Storage Requirements:

**FINISHES**

Full-height Cabinet:   
 Upper Millwork:   
 Countertop:   
 Lower Millwork:   
 Shelf:

Remarks:

**Legend:**

Category	Min. Length (mm)	Motorized Adjustable Height	Standing Height	Specialty Casework
Category 0 - None				
Category 1 - Low (1% - 4%)				
Category 2 - Med (5% - 9%)				
Category 3 - High (10% or Greater)				

**MECHANICAL REQUIREMENTS**

<b>PLUMBING</b> (Quantity) Hand Hygiene Sink: <input type="text"/> Lavatory: <input type="text"/> Kitchen Sink: <input type="text"/> Seamless Kitchen Sink: <input type="text"/> Utility / Process Sink: <input type="text"/> Scrub Sink: <input type="text"/> Floor Sink: <input type="text"/> Plumbing Remarks: <input type="text"/>		Other Fixtures: <input type="checkbox"/> Shower <input type="checkbox"/> Tub <input type="checkbox"/> Ice Maker <input type="checkbox"/> Water Closet <input type="checkbox"/> Instantaneous Hot Water <input checked="" type="checkbox"/> Eyewash Station <input type="checkbox"/> Eyewash/Shower Station <input type="checkbox"/> Emergency Shower <input type="checkbox"/> Flush Rim Sink <input checked="" type="checkbox"/> Floor Drain <input type="checkbox"/> Water Bottle Refill Station Other <input type="text"/>		<b>MED / NON-MED GASES</b> (Quantity) Oxygen: <input type="text"/> Medical Air: <input type="text"/> Medical Vacuum: <input type="text"/> Nitrous Oxide: <input type="text"/> CO2: <input type="text"/> AGSS: <input type="text"/> Nitrogen: <input type="text"/> Laboratory Air: <input type="text"/> Laboratory Vacuum: <input type="text"/> Utility Compressed Air: <input type="text"/> Gas Remarks: <input type="text"/>	
--	--	---	--	---	--

**Appendix 1B Minimum Room Requirements**

Room Name:

Program Number(s):

1. D2.29	7. L1.19	13. R3.12	19.	25.	31.	37.	43.
2. D4.01.08	8. M1.14	14. W1.05	20.	26.	32.	38.	44.
3. Not Used	9. M2.18	15. W6.04	21.	27.	33.	39.	45.
4. F7.12	10. M2.30	16. X3.02.06	22.	28.	34.	40.	46.
5. I2.23	11. P1.12	17.	23.	29.	35.	41.	47.
6. J2.02	12. R2.03	18.	24.	30.	36.	42.	48.

**ARCHITECTURAL REQUIREMENTS**

<b>WALL AND CEILING</b> Wall Material: <input type="text" value="ARGB 1.2m AFF, GB above"/> Finish: <input type="text" value="HPC"/> Ceiling Material: <input type="text" value="MMRGB"/> Finish: <input type="text" value="HPC"/>		<b>WALL PROTECTION</b> Type: <input type="text" value="WVV"/> <input checked="" type="checkbox"/> Corner Guards <input type="checkbox"/> Hand Rails <input type="checkbox"/> Bed Bumper / Locator Height: <input type="text" value="2185 mm"/> <input type="checkbox"/> Crash Rails <input type="checkbox"/> Chair Rail		<b>GLAZING</b> <input type="checkbox"/> Interior Glazing		<b>FLOORING TYPES</b> Material: <input type="text" value="WSVF"/> Base: <input type="text" value="FCB"/>		<b>ROOM ACCESSORIES</b> <input type="checkbox"/> Coat Hooks <input type="checkbox"/> Ceiling Lift <input type="checkbox"/> Magnetic Whiteboard <input type="checkbox"/> Mirror <input type="checkbox"/> Infant Change Table <input type="checkbox"/> Privacy Curtain	
--	--	---	--	---	--	---	--	--	--

- LEGEND:**
- WALL AND CEILING LEGEND:**
- AC Architectural Ceiling
  - ACT Acoustic Ceiling Tile
  - ACT-C Cleanroom
  - ARGB Abuse-Resistant Gypsum Board
  - GB Gypsum Board
  - IRGB Impact-Resistant Gypsum Board
  - KLCT Kitchen Lay-in Ceiling Tile
  - MMRGB Moisture and Mould-Resistant Gypsum Board
  - SACT Security Acoustic Ceiling Tile
- WALL FINISHES LEGEND:**
- EWC Epoxy Wall Coating
  - HPC High Performance Coating
  - PT Paint
- CEILING FINISHES LEGEND:**
- ECC Epoxy Ceiling Coating
  - HPC High Performance Coating
  - PF Prefinished
  - PT Paint
- WALL PROTECTION LEGEND:**
- ESRP Extruded Semi-Rigid PVCu Panel
  - FRL Fibre Reinforced Laminate
  - FRP Fibreglass Reinforced Plastic
  - PVV Protective Vinyl Wallcovering
  - RHIS Rigid High Impact Sheet
  - WSSP Wetwall Solid Surface Panel
  - WVV Wetroom Vinyl Wallcovering
- FLOOR FINISHES LEGEND:**
- CFS Concrete Floor Sealer
  - EFC Epoxy Floor Coating
  - PFC Polyurethane Floor Coating
  - RAF Rubber Athletic Flooring
  - RSF Rubber Sheet Flooring
  - SCF Seamless Cushioned Flooring
  - SDRF Static-Dissipative Rubber Sheet Flooring
  - SDVF Static-Dissipative Vinyl Sheet Flooring
  - VSF Vinyl Sheet Flooring
  - WSVF Wetroom Safety Vinyl Sheet Flooring
- FLOOR BASE LEGEND:**
- FCB Flash Cove Base
  - RB Rubber Base
  - SCF Seamless Cushioned Flooring

**DOORS**

Types:

Type	Qty	Size (mm)	Material	Finish	Side Lt.	Blinds	Protect.	Privacy Film	Function	Card Reader	Mag Lock	Auto Opener	Hold Open	Hinges	Accessory 1	Accessory 2	Accessory 3	Closer	

Door Remarks:  Security Grille  Anti-barricade strategy

**MILLWORK AND SPECIALTY CASEWORK**

**UPPER UNITS** (U1-U8) **SHELF** (S1)

**LOWER UNITS** (L1-L12) **RECEPTION/TRANSACTION COUNTER / CARE TEAM STATION DESK** (TC1, TC2) **UTILITY SINK AND COUNTER UNIT** (UC1)

**FULL-HEIGHT CABINETS** (C1-C5)

Storage Requirements:

**FINISHES**

Full-height Cabinet:   
 Upper Millwork:   
 Countertop:   
 Lower Millwork:   
 Shelf:

Remarks:

**Legend:**

Category	Min. Length (mm)	Motorized Adjustable Height	Standing Height	Specialty Casework
Category 0 - None				
Category 1 - Low (1% - 4%)				
Category 2 - Med (5% - 9%)				
Category 3 - High (10% or Greater)				

**MECHANICAL REQUIREMENTS**

<b>PLUMBING</b> (Quantity) Hygiene Sink: <input type="text"/> Lavatory: <input type="text"/> Kitchen Sink: <input type="text"/> Kitchen Sink: <input type="text"/> Utility / Process Sink: <input type="text"/> Scrub Sink: <input type="text"/> Floor Sink: <input type="text"/> Plumbing Remarks: <input type="text"/>		Other Fixtures: <input type="checkbox"/> Shower <input type="checkbox"/> Tub <input type="checkbox"/> Ice Maker <input type="checkbox"/> Water Closet <input type="checkbox"/> Instantaneous Hot Water <input type="checkbox"/> Eyewash Station <input checked="" type="checkbox"/> Eyewash/Shower Station <input type="checkbox"/> Emergency Shower <input type="checkbox"/> Flush Rim Sink <input checked="" type="checkbox"/> Floor Drain <input type="checkbox"/> Water Bottle Refill Station Other <input type="text"/>		<b>MED / NON-MED GASES</b> (Quantity) Oxygen: <input type="text"/> Medical Air: <input type="text"/> Medical Vacuum: <input type="text"/> Nitrous Oxide: <input type="text"/> CO2: <input type="text"/> AGSS: <input type="text"/> Nitrogen: <input type="text"/> Laboratory Air: <input type="text"/> Laboratory Vacuum: <input type="text"/> Utility Compressed Air: <input type="text"/> Gas Remarks: <input type="text"/>	
--	--	---	--	---	--

**Appendix 1B Minimum Room Requirements**

Room Name:

Program Number(s):

1. A2.06	7. C3.24	13. E2.01.06	19. M2.37	25.	31.	37.	43.
2. A3.10	8. C4.20	14. E3.01.15	20. P2.03.07	26.	32.	38.	44.
3. B1.09	9. C5.05	15. G2.03	21. Q1.02	27.	33.	39.	45.
4. B2.11	10. D4.01.03	16. I2.12	22. R2.02	28.	34.	40.	46.
5. B3.09	11. D4.02.01	17. M1.40	23. R3.11	29.	35.	41.	47.
6. C1.10	12. D6.09	18. M2.36	24.	30.	36.	42.	48.

**ARCHITECTURAL REQUIREMENTS**

<b>WALL AND CEILING</b> Wall Material: <input type="text" value="ARGB 1.2m AFF, GB above"/> Finish: <input type="text" value="PT"/> Ceiling Material: <input type="text" value="ACT"/> Finish: <input type="text" value="PF"/>		<b>WALL PROTECTION</b> Type: <input type="text" value="WVV"/> <input checked="" type="checkbox"/> Corner Guards <input type="checkbox"/> Hand Rails <input type="checkbox"/> Bed Bumper / Locator Height: <input type="text" value="2185 mm"/> <input type="checkbox"/> Crash Rails <input type="checkbox"/> Chair Rail		<b>GLAZING</b> <input type="checkbox"/> Interior Glazing		<b>FLOORING TYPES</b> Material: <input type="text" value="VSF"/> Base: <input type="text" value="FCB"/>		<b>ROOM ACCESSORIES</b> <input type="checkbox"/> Coat Hooks <input type="checkbox"/> Ceiling Lift <input type="checkbox"/> Magnetic Whiteboard <input type="checkbox"/> Mirror <input type="checkbox"/> Infant Change Table <input type="checkbox"/> Privacy Curtain	
--	--	---	--	---	--	--	--	--	--

- LEGEND:**
- WALL AND CEILING LEGEND:**
- AC Architectural Ceiling
  - ACT Acoustic Ceiling Tile
  - ACT-C Cleanroom
  - ARGB Abuse-Resistant Gypsum Board
  - GB Gypsum Board
  - IRGB Impact-Resistant Gypsum Board
  - KLCT Kitchen Lay-in Ceiling Tile
  - MMRGB Moisture and Mould-Resistant Gypsum Board
  - SACT Security Acoustic Ceiling Tile
- WALL FINISHES LEGEND:**
- EWC Epoxy Wall Coating
  - HPC High Performance Coating
  - PT Paint
- CEILING FINISHES LEGEND:**
- ECC Epoxy Ceiling Coating
  - HPC High Performance Coating
  - PF Prefinished
  - PT Paint
- WALL PROTECTION LEGEND:**
- ESRP Extruded Semi-Rigid PVCu Panel
  - FRL Fibre Reinforced Laminate
  - FRP Fibreglass Reinforced Plastic
  - PVV Protective Vinyl Wallcovering
  - RHIS Rigid High Impact Sheet
  - WSSP Wetwall Solid Surface Panel
  - WVV Wetroom Vinyl Wallcovering
- FLOOR FINISHES LEGEND:**
- CFS Concrete Floor Sealer
  - EFC Epoxy Floor Coating
  - PFC Polyurethane Floor Coating
  - RAF Rubber Athletic Flooring
  - RSF Rubber Sheet Flooring
  - SCF Seamless Cushioned Flooring
  - SDRF Static-Dissipative Rubber Sheet Flooring
  - SDVF Static-Dissipative Vinyl Sheet Flooring
  - VSF Vinyl Sheet Flooring
  - WSVF Wetroom Safety Vinyl Sheet Flooring
- FLOOR BASE LEGEND:**
- FCB Flash Cove Base
  - RB Rubber Base
  - SCF Seamless Cushioned Flooring

**DOORS**

Types:

Type	Qty	Size (mm)	Material	Finish	Side Lt.	Blinds	Protect.	Privacy Film	Function	Card Reader	Mag Lock	Auto Opener	Hold Open	Hinges	Accessory 1	Accessory 2	Accessory 3	Closer

Door Remarks:

Security Grille  
 Anti-barricade strategy

**MILLWORK AND SPECIALTY CASEWORK**

Storage Requirements:

**UPPER UNITS** (U1-U8)

**LOWER UNITS** (L1-L12)

**RECEPTION/TRANSACTION COUNTER / CARE TEAM STATION DESK** (TC1, TC2)

**UTILITY SINK AND COUNTER UNIT** (UC1)

**SHELF** (S1)

**FULL-HEIGHT CABINETS** (C1-C5)

**Legend:**

Category	Min. Length (mm)	Motorized Adjustable Height	Standing Height	Specialty Casework
Category 0 - None				
Category 1 - Low (1% - 4%)				
Category 2 - Med (5% - 9%)				
Category 3 - High (10% or Greater)				

**FINISHES**

Full-height Cabinet:

Upper Millwork:

Countertop:

Lower Millwork:

Shelf:

Remarks:

**MECHANICAL REQUIREMENTS**

<b>PLUMBING</b> (Quantity)		Hand Hygiene Sink: <input type="text" value="1"/>		Lavatory: <input type="text"/>		Kitchen Sink: <input type="text"/>		Seamless Kitchen Sink: <input type="text"/>		Utility / Process Sink: <input type="text"/>		Scrub Sink: <input type="text"/>		Floor Sink: <input type="text"/>							
Plumbing Remarks: <input type="text"/>		Other Fixtures:		<input type="checkbox"/> Shower <input type="checkbox"/> Tub <input type="checkbox"/> Ice Maker <input type="checkbox"/> Water Closet <input type="checkbox"/> Instantaneous Hot Water		<input type="checkbox"/> Eyewash Station <input type="checkbox"/> Eyewash/Shower Station <input type="checkbox"/> Emergency Shower <input type="checkbox"/> Flush Rim Sink <input type="checkbox"/> Floor Drain <input type="checkbox"/> Water Bottle Refill Station		Other: <input type="text"/>		<b>MED / NON-MED GASES</b> (Quantity)											
		Oxygen: <input type="text"/>		Medical Air: <input type="text"/>		Medical Vacuum: <input type="text"/>		Nitrous Oxide: <input type="text"/>		CO2: <input type="text"/>		AGSS: <input type="text"/>		Nitrogen: <input type="text"/>		Laboratory Air: <input type="text"/>		Laboratory Vacuum: <input type="text"/>		Utility Compressed Air: <input type="text"/>	
		Gas Remarks: <input type="text"/>																			



**Appendix 1B Minimum Room Requirements**

Room Name:

Program Number(s):

1. D7.14	7.	13.	19.	25.	31.	37.	43.
2. R3.10	8.	14.	20.	26.	32.	38.	44.
3. Y1.12	9.	15.	21.	27.	33.	39.	45.
4.	10.	16.	22.	28.	34.	40.	46.
5.	11.	17.	23.	29.	35.	41.	47.
6.	12.	18.	24.	30.	36.	42.	48.

**ARCHITECTURAL REQUIREMENTS**

<b>WALL AND CEILING</b> Wall Material: <input type="text" value="ARGB 1.2m AFF, GB above"/> Finish: <input type="text" value="PT"/> Ceiling Material: <input type="text" value="ACT"/> Finish: <input type="text" value="PF"/>		<b>WALL PROTECTION</b> Type: <input type="text" value="PVW"/> <input checked="" type="checkbox"/> Corner Guards <input type="checkbox"/> Hand Rails <input type="checkbox"/> Bed Bumper / Locator Height: <input type="text" value="2185 mm"/> <input type="checkbox"/> Crash Rails <input type="checkbox"/> Chair Rail		<b>GLAZING</b> <input type="checkbox"/> Interior Glazing		<b>FLOORING TYPES</b> Material: <input type="text" value="VSF"/> Base: <input type="text" value="FCB"/>		<b>ROOM ACCESSORIES</b> <input type="checkbox"/> Coat Hooks <input type="checkbox"/> Ceiling Lift <input type="checkbox"/> Magnetic Whiteboard <input type="checkbox"/> Mirror <input type="checkbox"/> Infant Change Table <input type="checkbox"/> Privacy Curtain	
--	--	---	--	---	--	--	--	--	--

- LEGEND:**
- WALL AND CEILING LEGEND:**
- AC Architectural Ceiling
  - ACT Acoustic Ceiling Tile
  - ACT-C Cleanroom
  - ARGB Abuse-Resistant Gypsum Board
  - GB Gypsum Board
  - IRGB Impact-Resistant Gypsum Board
  - KLCT Kitchen Lay-in Ceiling Tile
  - MMRGB Moisture and Mould-Resistant Gypsum Board
  - SACT Security Acoustic Ceiling Tile
- WALL FINISHES LEGEND:**
- EWC Epoxy Wall Coating
  - HPC High Performance Coating
  - PT Paint
- CEILING FINISHES LEGEND:**
- ECC Epoxy Ceiling Coating
  - HPC High Performance Coating
  - PF Prefinished
  - PT Paint
- WALL PROTECTION LEGEND:**
- ESRP Extruded Semi-Rigid PVCu Panel
  - FRL Fibre Reinforced Laminate
  - FRP Fibreglass Reinforced Plastic
  - PVW Protective Vinyl Wallcovering
  - RHIS Rigid High Impact Sheet
  - WSSP Wetwall Solid Surface Panel
  - WVV Wetroom Vinyl Wallcovering
- FLOOR FINISHES LEGEND:**
- CFS Concrete Floor Sealer
  - EFC Epoxy Floor Coating
  - PFC Polyurethane Floor Coating
  - RAF Rubber Athletic Flooring
  - RSF Rubber Sheet Flooring
  - SCF Seamless Cushioned Flooring
  - SDRF Static-Dissipative Rubber Sheet Flooring
  - SDVF Static-Dissipative Vinyl Sheet Flooring
  - VSF Vinyl Sheet Flooring
  - WSVF Wetroom Safety Vinyl Sheet Flooring
- FLOOR BASE LEGEND:**
- FCB Flash Cove Base
  - RB Rubber Base
  - SCF Seamless Cushioned Flooring

**DOORS**

Types:

Type	Qty	Size (mm)	Material	Finish	Side Lt.	Blinds	Protect.	Privacy Film	Function	Card Reader	Mag Lock	Auto Opener	Hold Open	Hinges	Accessory 1	Accessory 2	Accessory 3	Closer

Door Remarks:  Security Grille  Anti-barricade strategy

**MILLWORK AND SPECIALTY CASEWORK**

Storage Requirements: D7.14 - (24) half lockers, R3.10 - (6) half lockers, Y1.12 - (50) half lockers

**FINISHES**

Full-height Cabinet:

Upper Millwork:

Countertop:

Lower Millwork:

Shelf:

Remarks:

**MECHANICAL REQUIREMENTS**

<b>PLUMBING</b> (Quantity) Hand Hygiene Sink: <input type="text"/> Lavatory: <input type="text"/> Kitchen Sink: <input type="text"/> Seamless Kitchen Sink: <input type="text"/> Utility / Process Sink: <input type="text"/> Scrub Sink: <input type="text"/> Floor Sink: <input type="text"/>							Other Fixtures: <input type="checkbox"/> Shower <input type="checkbox"/> Eyewash Station <input type="checkbox"/> Tub <input type="checkbox"/> Eyewash/Shower Station <input type="checkbox"/> Ice Maker <input type="checkbox"/> Emergency Shower <input type="checkbox"/> Water Closet <input type="checkbox"/> Flush Rim Sink <input type="checkbox"/> Instantaneous Hot Water <input type="checkbox"/> Floor Drain <input type="checkbox"/> Water Bottle Refill Station Other <input type="text"/>				<b>MED / NON-MED GASES</b> (Quantity) Oxygen: <input type="text"/> Medical Air: <input type="text"/> Medical Vacuum: <input type="text"/> Nitrous Oxide: <input type="text"/> CO2: <input type="text"/> AGSS: <input type="text"/> Nitrogen: <input type="text"/> Laboratory Air: <input type="text"/> Laboratory Vacuum: <input type="text"/> Utility Compressed Air: <input type="text"/>					
Plumbing Remarks: <input type="text"/>											Gas Remarks: <input type="text"/>					

**Appendix 1B Minimum Room Requirements**

Room Name:

Program Number(s):

1. D6.10	7.	13.	19.	25.	31.	37.	43.
2. F6.04	8.	14.	20.	26.	32.	38.	44.
3. K3.03	9.	15.	21.	27.	33.	39.	45.
4. K4.04	10.	16.	22.	28.	34.	40.	46.
5.	11.	17.	23.	29.	35.	41.	47.
6.	12.	18.	24.	30.	36.	42.	48.

**ARCHITECTURAL REQUIREMENTS**

<b>WALL AND CEILING</b> Wall Material: <input type="text" value="ARGB 1.2m AFF, GB above"/> Finish: <input type="text" value="PT"/> Ceiling Material: <input type="text" value="ACT"/> Finish: <input type="text" value="PF"/>		<b>WALL PROTECTION</b> Type: <input type="text" value="PVW"/> <input checked="" type="checkbox"/> Corner Guards <input type="checkbox"/> Hand Rails <input type="checkbox"/> Bed Bumper / Locator Height: <input type="text" value="2185 mm"/> <input type="checkbox"/> Crash Rails <input type="checkbox"/> Chair Rail		<b>GLAZING</b> <input type="checkbox"/> Interior Glazing		<b>FLOORING TYPES</b> Material: <input type="text" value="VSF"/> Base: <input type="text" value="FCB"/>		<b>ROOM ACCESSORIES</b> <input type="checkbox"/> Coat Hooks <input type="checkbox"/> Ceiling Lift <input type="checkbox"/> Magnetic Whiteboard <input type="checkbox"/> Mirror <input type="checkbox"/> Infant Change Table <input type="checkbox"/> Privacy Curtain	
--	--	---	--	---	--	--	--	--	--

- LEGEND:**
- WALL AND CEILING LEGEND:**
- AC Architectural Ceiling
  - ACT Acoustic Ceiling Tile
  - ACT-C Cleanroom
  - ARGB Abuse-Resistant Gypsum Board
  - GB Gypsum Board
  - IRGB Impact-Resistant Gypsum Board
  - KLCT Kitchen Lay-in Ceiling Tile
  - MMRGB Moisture and Mould-Resistant Gypsum Board
  - SACT Security Acoustic Ceiling Tile
- WALL FINISHES LEGEND:**
- EWC Epoxy Wall Coating
  - HPC High Performance Coating
  - PT Paint
- CEILING FINISHES LEGEND:**
- ECC Epoxy Ceiling Coating
  - HPC High Performance Coating
  - PF Prefinished
  - PT Paint
- WALL PROTECTION LEGEND:**
- ESRP Extruded Semi-Rigid PVCu Panel
  - FRL Fibre Reinforced Laminate
  - FRP Fibreglass Reinforced Plastic
  - PVW Protective Vinyl Wallcovering
  - RHIS Rigid High Impact Sheet
  - WSSP Wetwall Solid Surface Panel
  - WVV Wetroom Vinyl Wallcovering
- FLOOR FINISHES LEGEND:**
- CFS Concrete Floor Sealer
  - EFC Epoxy Floor Coating
  - PFC Polyurethane Floor Coating
  - RAF Rubber Athletic Flooring
  - RSF Rubber Sheet Flooring
  - SCF Seamless Cushioned Flooring
  - SDRF Static-Dissipative Rubber Sheet Flooring
  - SDVF Static-Dissipative Vinyl Sheet Flooring
  - VSF Vinyl Sheet Flooring
  - WSVF Wetroom Safety Vinyl Sheet Flooring
- FLOOR BASE LEGEND:**
- FCB Flash Cove Base
  - RB Rubber Base
  - SCF Seamless Cushioned Flooring

**DOORS**

Types:

Type	Qty	Size (mm)	Material	Finish	Side Lt.	Blinds	Protect.	Privacy Film	Function	Card Reader	Mag Lock	Auto Opener	Hold Open	Hinges	Accessory 1	Accessory 2	Accessory 3	Closer

Door Remarks:  Security Grille  Anti-barricade strategy

**MILLWORK AND SPECIALTY CASEWORK**

Storage Requirements: D6.10 - (50) half lockers, F6.04 - (4) half lockers, K3.03 - (6) half locker, K4.04 - (4) half lockers

**FINISHES**

Full-height Cabinet:   
 Upper Millwork:   
 Countertop:   
 Lower Millwork:   
 Shelf:

Remarks:

**MECHANICAL REQUIREMENTS**

<b>PLUMBING</b> (Quantity) Hygiene Sink: <input type="text"/> Lavatory: <input type="text"/> Kitchen Sink: <input type="text"/> Kitchen Sink: <input type="text"/> Utility / Process Sink: <input type="text"/> Scrub Sink: <input type="text"/> Floor Sink: <input type="text"/> Plumbing Remarks: <input type="text"/>							Other Fixtures: <input type="checkbox"/> Shower <input type="checkbox"/> Eyewash Station <input type="checkbox"/> Tub <input type="checkbox"/> Eyewash/Shower Station <input type="checkbox"/> Ice Maker <input type="checkbox"/> Emergency Shower <input type="checkbox"/> Water Closet <input type="checkbox"/> Flush Rim Sink <input type="checkbox"/> Instantaneous Hot Water <input type="checkbox"/> Floor Drain <input type="checkbox"/> Water Bottle Refill Station Other <input type="text"/>				<b>MED / NON-MED GASES</b> (Quantity) Oxygen: <input type="text"/> Medical Air: <input type="text"/> Medical Vacuum: <input type="text"/> Nitrous Oxide: <input type="text"/> CO2: <input type="text"/> AGSS: <input type="text"/> Nitrogen: <input type="text"/> Laboratory Air: <input type="text"/> Laboratory Vacuum: <input type="text"/> Utility Compressed Air: <input type="text"/> Gas Remarks: <input type="text"/>					
--	--	--	--	--	--	--	---	--	--	--	---	--	--	--	--	--

**Appendix 1B Minimum Room Requirements**

Room Name:

Program Number(s):

1. W6.05	7.	13.	19.	25.	31.	37.	43.
2. W1.12	8.	14.	20.	26.	32.	38.	44.
3.	9.	15.	21.	27.	33.	39.	45.
4.	10.	16.	22.	28.	34.	40.	46.
5.	11.	17.	23.	29.	35.	41.	47.
6.	12.	18.	24.	30.	36.	42.	48.

**ARCHITECTURAL REQUIREMENTS**

<b>WALL AND CEILING</b> Wall Material: <input type="text" value="ARGB 1.2m AFF, GB above"/> Finish: <input type="text" value="PT"/> Ceiling Material: <input type="text" value="ACT"/> Finish: <input type="text" value="PF"/>	<b>WALL PROTECTION</b> Type: <input type="text" value="PVW"/> <input checked="" type="checkbox"/> Corner Guards <input type="checkbox"/> Hand Rails <input type="checkbox"/> Bed Bumper / Locator Height: <input type="text" value="2185 mm"/> <input checked="" type="checkbox"/> Crash Rails <input type="checkbox"/> Chair Rail	<b>GLAZING</b> <input type="checkbox"/> Interior Glazing	<b>FLOORING TYPES</b> Material: <input type="text" value="EFC"/> Base: <input type="text" value="EFC"/>	<b>ROOM ACCESSORIES</b> <input type="checkbox"/> Coat Hooks <input type="checkbox"/> Ceiling Lift <input type="checkbox"/> Magnetic Whiteboard <input type="checkbox"/> Mirror <input type="checkbox"/> Infant Change Table <input type="checkbox"/> Privacy Curtain
--	--	---	--	--

- LEGEND:**
- WALL AND CEILING LEGEND:**
- AC Architectural Ceiling
  - ACT Acoustic Ceiling Tile
  - ACT-C Cleanroom
  - ARGB Abuse-Resistant Gypsum Board
  - GB Gypsum Board
  - IRGB Impact-Resistant Gypsum Board
  - KLCT Kitchen Lay-in Ceiling Tile
  - MMRGB Moisture and Mould-Resistant Gypsum Board
  - SACT Security Acoustic Ceiling Tile
- WALL FINISHES LEGEND:**
- EWC Epoxy Wall Coating
  - HPC High Performance Coating
  - PT Paint
- CEILING FINISHES LEGEND:**
- ECC Epoxy Ceiling Coating
  - HPC High Performance Coating
  - PF Prefinished
  - PT Paint
- WALL PROTECTION LEGEND:**
- ESRP Extruded Semi-Rigid PVCu Panel
  - FRL Fibre Reinforced Laminate
  - FRP Fibreglass Reinforced Plastic
  - PVW Protective Vinyl Wallcovering
  - RHIS Rigid High Impact Sheet
  - WSSP Wetwall Solid Surface Panel
  - WVV Wetroom Vinyl Wallcovering
- FLOOR FINISHES LEGEND:**
- CFS Concrete Floor Sealer
  - EFC Epoxy Floor Coating
  - PFC Polyurethane Floor Coating
  - RAF Rubber Athletic Flooring
  - RSF Rubber Sheet Flooring
  - SCF Seamless Cushioned Flooring
  - SDRF Static-Dissipative Rubber Sheet Flooring
  - SDVF Static-Dissipative Vinyl Sheet Flooring
  - VSF Vinyl Sheet Flooring
  - WSVF Wetroom Safety Vinyl Sheet Flooring
- FLOOR BASE LEGEND:**
- FCB Flash Cove Base
  - RB Rubber Base
  - SCF Seamless Cushioned Flooring

**DOORS**

Types:

Type	Qty	Size (mm)	Material	Finish	Side Lt.	Blinds	Protect.	Privacy Film	Function	Card Reader	Mag Lock	Auto Opener	Hold Open	Hinges	Accessory 1	Accessory 2	Accessory 3	Closer	

Door Remarks:  Security Grille  Anti-barricade strategy

**MILLWORK AND SPECIALTY CASEWORK**

Storage Requirements: B3.21 - (1) alcove to support blanket warmer

**UPPER UNITS** (U1-U8) **SHELF** (S1)

**FULL-HEIGHT CABINETS** (C1-C5) **LOWER UNITS** (L1-L12) **RECEPTION/TRANSACTION COUNTER / CARE TEAM STATION DESK** (TC1-TC2) **UTILITY SINK AND COUNTER UNIT** (UC1)

Category	Min. Length (mm)	Motorized Adjustable Height	Standing Height	Specialty Casework
Category 0 - None				
Category 1 - Low (1% - 4%)				
Category 2 - Med (5% - 9%)				
Category 3 - High (10% or Greater)				

**FINISHES**

Full-height Cabinet:   
 Upper Millwork:   
 Countertop:   
 Lower Millwork:   
 Shelf:

Remarks:

**MECHANICAL REQUIREMENTS**

<b>PLUMBING</b> (Quantity) Hand Hygiene Sink: <input type="text"/> Lavatory: <input type="text"/> Kitchen Sink: <input type="text"/> Seamless Kitchen Sink: <input type="text"/> Utility / Process Sink: <input type="text"/> Scrub Sink: <input type="text"/> Floor Sink: <input type="text"/> Plumbing Remarks: <input type="text"/>	Other Fixtures: <input type="checkbox"/> Shower <input type="checkbox"/> Eyewash Station <input type="checkbox"/> Tub <input type="checkbox"/> Eyewash/Shower Station <input type="checkbox"/> Ice Maker <input type="checkbox"/> Emergency Shower <input type="checkbox"/> Water Closet <input type="checkbox"/> Flush Rim Sink <input type="checkbox"/> Instantaneous Hot Water <input type="checkbox"/> Floor Drain <input type="checkbox"/> <input type="checkbox"/> Water Bottle Refill Station Other <input type="text"/>	<b>MED / NON-MED GASES</b> (Quantity) Oxygen: <input type="text"/> Medical Air: <input type="text"/> Medical Vacuum: <input type="text"/> Nitrous Oxide: <input type="text"/> CO2: <input type="text"/> AGSS: <input type="text"/> Nitrogen: <input type="text"/> Laboratory Air: <input type="text"/> Laboratory Vacuum: <input type="text"/> Utility Compressed Air: <input type="text"/> Gas Remarks: <input type="text"/>
---	--	---



**Appendix 1B Minimum Room Requirements**

Room Name:

Program Number(s):

1. W1.13	7.	13.	19.	25.	31.	37.	43.
2.	8.	14.	20.	26.	32.	38.	44.
3.	9.	15.	21.	27.	33.	39.	45.
4.	10.	16.	22.	28.	34.	40.	46.
5.	11.	17.	23.	29.	35.	41.	47.
6.	12.	18.	24.	30.	36.	42.	48.

**ARCHITECTURAL REQUIREMENTS**

<b>WALL AND CEILING</b> Wall Material: <input type="text" value="ARGB 1.2m AFF, GB above"/> Finish: <input type="text" value="PT"/> Ceiling Material: <input type="text" value="ACT"/> Finish: <input type="text" value="PF"/>	<b>WALL PROTECTION</b> Type: <input type="text" value="PVW"/> <input checked="" type="checkbox"/> Corner Guards <input type="checkbox"/> Hand Rails <input type="checkbox"/> Bed Bumper / Locator Height: <input type="text" value="2185 mm"/> <input checked="" type="checkbox"/> Crash Rails <input type="checkbox"/> Chair Rail	<b>GLAZING</b> <input type="checkbox"/> Interior Glazing	<b>FLOORING TYPES</b> Material: <input type="text" value="EFC"/> Base: <input type="text" value="EFC"/>	<b>ROOM ACCESSORIES</b> <input type="checkbox"/> Coat Hooks <input type="checkbox"/> Ceiling Lift <input type="checkbox"/> Magnetic Whiteboard <input type="checkbox"/> Mirror <input type="checkbox"/> Infant Change Table <input type="checkbox"/> Privacy Curtain
--	--	---	--	--

- LEGEND:**
- WALL AND CEILING LEGEND:**
- AC Architectural Ceiling
  - ACT Acoustic Ceiling Tile
  - ACT-C Cleanroom
  - ARGB Abuse-Resistant Gypsum Board
  - GB Gypsum Board
  - IRGB Impact-Resistant Gypsum Board
  - KLCT Kitchen Lay-in Ceiling Tile
  - MMRGB Moisture and Mould-Resistant Gypsum Board
  - SACT Security Acoustic Ceiling Tile
- WALL FINISHES LEGEND:**
- EWC Epoxy Wall Coating
  - HPC High Performance Coating
  - PT Paint
- CEILING FINISHES LEGEND:**
- ECC Epoxy Ceiling Coating
  - HPC High Performance Coating
  - PF Prefinished
  - PT Paint
- WALL PROTECTION LEGEND:**
- ESRP Extruded Semi-Rigid PVCu Panel
  - FRL Fibre Reinforced Laminate
  - FRP Fibreglass Reinforced Plastic
  - PVW Protective Vinyl Wallcovering
  - RHIS Rigid High Impact Sheet
  - WSSP Wetwall Solid Surface Panel
  - WVV Wetroom Vinyl Wallcovering
- FLOOR FINISHES LEGEND:**
- CFS Concrete Floor Sealer
  - EFC Epoxy Floor Coating
  - PFC Polyurethane Floor Coating
  - RAF Rubber Athletic Flooring
  - RSF Rubber Sheet Flooring
  - SCF Seamless Cushioned Flooring
  - SDRF Static-Dissipative Rubber Sheet Flooring
  - SDVF Static-Dissipative Vinyl Sheet Flooring
  - VSF Vinyl Sheet Flooring
  - WSVF Wetroom Safety Vinyl Sheet Flooring
- FLOOR BASE LEGEND:**
- FCB Flash Cove Base
  - RB Rubber Base
  - SCF Seamless Cushioned Flooring

**DOORS**

Types:

Type	Qty	Size (mm)	Material	Finish	Side Lt	Blinds	Protect	Privacy Film	Function	Card Reader	Mag Lock	Auto Opener	Hold Open	Hinges	Accessory 1	Accessory 2	Accessory 3	Closer

Door Remarks:  Security Grille  Anti-barricade strategy

**MILLWORK AND SPECIALTY CASEWORK**

Storage Requirements: B3.21 - (1) alcove to support blanket warmer

**UPPER UNITS** (U1-U8)

**LOWER UNITS** (L1-L12)

**RECEPTION/TRANSACTION COUNTER / CARE TEAM STATION DESK** (TC1, TC2)

**UTILITY SINK AND COUNTER UNIT** (UC1)

**FINISHES**

Full-height Cabinet:

Upper Millwork:

Countertop:

Lower Millwork:

Shelf:

Remarks:

**Legend:**

Category	Min. Length (mm)	Motorized Adjustable Height	Standing Height	Specialty Casework
Category 0 - None				
Category 1 - Low (1% - 4%)				
Category 2 - Med (5% - 9%)				
Category 3 - High (10% or Greater)				

**MECHANICAL REQUIREMENTS**

<b>PLUMBING</b> (Quantity) Hand Hygiene Sink: <input type="text"/> Lavatory: <input type="text"/> Kitchen Sink: <input type="text"/> Seamless Kitchen Sink: <input type="text"/> Utility / Process Sink: <input type="text"/> Scrub Sink: <input type="text"/> Floor Sink: <input type="text"/> Plumbing Remarks: <input type="text"/>	Other Fixtures: <input type="checkbox"/> Shower <input type="checkbox"/> Eyewash Station <input type="checkbox"/> Tub <input type="checkbox"/> Eyewash/Shower Station <input type="checkbox"/> Ice Maker <input type="checkbox"/> Emergency Shower <input type="checkbox"/> Water Closet <input type="checkbox"/> Flush Rim Sink <input type="checkbox"/> Instantaneous Hot Water <input type="checkbox"/> Floor Drain <input type="checkbox"/> <input type="checkbox"/> Water Bottle Refill Station Other: <input type="text"/>	<b>MED / NON-MED GASES</b> (Quantity) Oxygen: <input type="text"/> Medical Air: <input type="text"/> Medical Vacuum: <input type="text"/> Nitrous Oxide: <input type="text"/> CO2: <input type="text"/> AGSS: <input type="text"/> Nitrogen: <input type="text"/> Laboratory Air: <input type="text"/> Laboratory Vacuum: <input type="text"/> Utility Compressed Air: <input type="text"/> Gas Remarks: <input type="text"/>
---	---	---

**Appendix 1B Minimum Room Requirements**

Room Name:

Program Number(s):

1. A2.08	7. C3.28	13. F4.15	19.	25.	31.	37.	43.
2. A3.13	8. C4.24	14. G1.18	20.	26.	32.	38.	44.
3. B1.18	9. D2.24	15. N1.06	21.	27.	33.	39.	45.
4. B2.20	10. D3.08	16.	22.	28.	34.	40.	46.
5. B3.21	11. D6.15	17.	23.	29.	35.	41.	47.
6. C3.04	12. F2.13	18.	24.	30.	36.	42.	48.

**ARCHITECTURAL REQUIREMENTS**

<b>WALL AND CEILING</b> Wall Material: <input type="text" value="ARGB 1.2m AFF, GB above"/> Finish: <input type="text" value="PT"/> Ceiling Material: <input type="text" value="ACT"/> Finish: <input type="text" value="PF"/>		<b>WALL PROTECTION</b> Type: <input type="text" value="PVW"/> <input checked="" type="checkbox"/> Corner Guards <input type="checkbox"/> Hand Rails <input type="checkbox"/> Bed Bumper / Locator Height: <input type="text" value="2185 mm"/> <input checked="" type="checkbox"/> Crash Rails <input type="checkbox"/> Chair Rail		<b>GLAZING</b> <input type="checkbox"/> Interior Glazing		<b>FLOORING TYPES</b> Material: <input type="text" value="VSF"/> Base: <input type="text" value="FCB"/>		<b>ROOM ACCESSORIES</b> <input type="checkbox"/> Coat Hooks <input type="checkbox"/> Ceiling Lift <input type="checkbox"/> Magnetic Whiteboard <input type="checkbox"/> Mirror <input type="checkbox"/> Infant Change Table <input type="checkbox"/> Privacy Curtain	
--	--	--	--	---	--	--	--	--	--

- LEGEND:**
- WALL AND CEILING LEGEND:**
- AC Architectural Ceiling
  - ACT Acoustic Ceiling Tile
  - ACT-C Cleanroom
  - ARGB Abuse-Resistant Gypsum Board
  - GB Gypsum Board
  - IRGB Impact-Resistant Gypsum Board
  - KLCT Kitchen Lay-in Ceiling Tile
  - MMRGB Moisture and Mould-Resistant Gypsum Board
  - SACT Security Acoustic Ceiling Tile
- WALL FINISHES LEGEND:**
- EWC Epoxy Wall Coating
  - HPC High Performance Coating
  - PT Paint
- CEILING FINISHES LEGEND:**
- ECC Epoxy Ceiling Coating
  - HPC High Performance Coating
  - PF Prefinished
  - PT Paint
- WALL PROTECTION LEGEND:**
- ESRP Extruded Semi-Rigid PVCu Panel
  - FRL Fibre Reinforced Laminate
  - FRP Fibreglass Reinforced Plastic
  - PVW Protective Vinyl Wallcovering
  - RHIS Rigid High Impact Sheet
  - WSSP Wetwall Solid Surface Panel
  - WVV Wetroom Vinyl Wallcovering
- FLOOR FINISHES LEGEND:**
- CFS Concrete Floor Sealer
  - EFC Epoxy Floor Coating
  - PFC Polyurethane Floor Coating
  - RAF Rubber Athletic Flooring
  - RSF Rubber Sheet Flooring
  - SCF Seamless Cushioned Flooring
  - SDRF Static-Dissipative Rubber Sheet Flooring
  - SDVF Static-Dissipative Vinyl Sheet Flooring
  - VSF Vinyl Sheet Flooring
  - WSVF Wetroom Safety Vinyl Sheet Flooring
- FLOOR BASE LEGEND:**
- FCB Flash Cove Base
  - RB Rubber Base
  - SCF Seamless Cushioned Flooring

**DOORS**

Types:

Type:Qty:	Size (mm):	Material:	Finish:	Side Lt:	Blinds:	Protect.:	Privacy Film:	Function:	Card Reader:	Mag Lock:	Auto Opener:	Hold Open:	Hinges:	Accessory 1:	Accessory 2:	Accessory 3:	Closer:

Door Remarks:  Security Grille  Anti-barricade strategy

**MILLWORK AND SPECIALTY CASEWORK**

Storage Requirements:  B3.21 - (1) alcove to support blanket warmer

**UPPER UNITS** (U1-U8) **SHELF** (S1)

**LOWER UNITS** (L1-L12) **RECEPTION/TRANSACTION COUNTER / CARE TEAM STATION DESK** (TC1, TC2) **UTILITY SINK AND COUNTER UNIT** (UC1)

**FULL-HEIGHT CABINETS** (C1-C5)

**Legend:**

Category	Min. Length (mm)	Motorized Adjustable Height	Standing Height	Specialty Casework
Category 0 - None				
Category 1 - Low (1% - 4%)				
Category 2 - Med (5% - 9%)				
Category 3 - High (10% or Greater)				

**FINISHES**

Full-height Cabinet:   
 Upper Millwork:   
 Countertop:   
 Lower Millwork:   
 Shelf:

Remarks:

**MECHANICAL REQUIREMENTS**

<b>PLUMBING</b> (Quantity) Hand Hygiene Sink: <input type="text"/> Lavatory: <input type="text"/> Kitchen Sink: <input type="text"/> Seamless Kitchen Sink: <input type="text"/> Utility / Process Sink: <input type="text"/> Scrub Sink: <input type="text"/> Floor Sink: <input type="text"/> Plumbing Remarks: <input type="text"/>		Other Fixtures: <input type="checkbox"/> Shower <input type="checkbox"/> Eyewash Station <input type="checkbox"/> Tub <input type="checkbox"/> Eyewash/Shower Station <input type="checkbox"/> Ice Maker <input type="checkbox"/> Emergency Shower <input type="checkbox"/> Water Closet <input type="checkbox"/> Flush Rim Sink <input type="checkbox"/> Instantaneous Hot Water <input type="checkbox"/> Floor Drain <input type="checkbox"/> Water Bottle Refill Station Other: <input type="text"/>		<b>MED / NON-MED GASES</b> (Quantity) Oxygen: <input type="text"/> Medical Air: <input type="text"/> Medical Vacuum: <input type="text"/> Nitrous Oxide: <input type="text"/> CO2: <input type="text"/> AGSS: <input type="text"/> Nitrogen: <input type="text"/> Laboratory Air: <input type="text"/> Laboratory Vacuum: <input type="text"/> Utility Compressed Air: <input type="text"/> Gas Remarks: <input type="text"/>	
--	--	--	--	--	--

**Appendix 1B Minimum Room Requirements**

Room Name:

Program Number(s):

1. A3.12	7. D6.14	13. T4.05	19.	25.	31.	37.	43.
2. B1.13	8. G1.09	14. V1.02	20.	26.	32.	38.	44.
3. B2.12	9. I2.17	15.	21.	27.	33.	39.	45.
4. B3.11	10. L2.20	16.	22.	28.	34.	40.	46.
5. C3.26	11. M1.07	17.	23.	29.	35.	41.	47.
6. C4.22	12. N3.07	18.	24.	30.	36.	42.	48.

**ARCHITECTURAL REQUIREMENTS**

<b>WALL AND CEILING</b> Wall Material: <input type="text" value="ARGB 1.2m AFF, GB above"/> Finish: <input type="text" value="EWC"/> Ceiling Material: <input type="text" value="ACT"/> Finish: <input type="text" value="PF"/>		<b>WALL PROTECTION</b> Type: <input type="text" value="WVW"/> <input checked="" type="checkbox"/> Corner Guards <input type="checkbox"/> Hand Rails <input type="checkbox"/> Bed Bumper / Locator Height: <input type="text" value="2185 mm"/> <input type="checkbox"/> Crash Rails <input type="checkbox"/> Chair Rail		<b>GLAZING</b> <input type="checkbox"/> Interior Glazing		<b>FLOORING TYPES</b> Material: <input type="text" value="WSVF"/> Base: <input type="text" value="FCB"/>		<b>ROOM ACCESSORIES</b> <input type="checkbox"/> Coat Hooks <input type="checkbox"/> Ceiling Lift <input type="checkbox"/> Magnetic Whiteboard <input type="checkbox"/> Mirror <input type="checkbox"/> Infant Change Table <input type="checkbox"/> Privacy Curtain	
---	--	---	--	---	--	---	--	--	--

- LEGEND:**
- WALL AND CEILING LEGEND:**
- AC Architectural Ceiling
  - ACT Acoustic Ceiling Tile
  - ACT-C Cleanroom
  - ARGB Abuse-Resistant Gypsum Board
  - GB Gypsum Board
  - IRGB Impact-Resistant Gypsum Board
  - KLCT Kitchen Lay-in Ceiling Tile
  - MMRGB Moisture and Mould-Resistant Gypsum Board
  - SACT Security Acoustic Ceiling Tile
- WALL FINISHES LEGEND:**
- EWC Epoxy Wall Coating
  - HPC High Performance Coating
  - PT Paint
- CEILING FINISHES LEGEND:**
- ECC Epoxy Ceiling Coating
  - HPC High Performance Coating
  - PF Prefinished
  - PT Paint
- WALL PROTECTION LEGEND:**
- ESRP Extruded Semi-Rigid PVCu Panel
  - FRL Fibre Reinforced Laminate
  - FRP Fibreglass Reinforced Plastic
  - PVW Protective Vinyl Wallcovering
  - RHIS Rigid High Impact Sheet
  - WSSP Wetwall Solid Surface Panel
  - WVW Wetroom Vinyl Wallcovering
- FLOOR FINISHES LEGEND:**
- CFS Concrete Floor Sealer
  - EFC Epoxy Floor Coating
  - PFC Polyurethane Floor Coating
  - RAF Rubber Athletic Flooring
  - RSF Rubber Sheet Flooring
  - SCF Seamless Cushioned Flooring
  - SDRF Static-Dissipative Rubber Sheet Flooring
  - SDVF Static-Dissipative Vinyl Sheet Flooring
  - VSF Vinyl Sheet Flooring
  - WSVF Wetroom Safety Vinyl Sheet Flooring
- FLOOR BASE LEGEND:**
- FCB Flash Cove Base
  - RB Rubber Base
  - SCF Seamless Cushioned Flooring

**DOORS**

Types:

Type:Qty:	Size (mm):	Material:	Finish:	Side Lt:	Blinds:	Protect.:	Privacy Film:	Function:	Card Reader:	Mag Lock:	Auto Opener:	Hold Open:	Hinges:	Accessory 1:	Accessory 2:	Accessory 3:	Closer:

Door Remarks:  Security Grille  Anti-barricade strategy

**MILLWORK AND SPECIALTY CASEWORK**

Storage Requirements:

**UPPER UNITS** (U1-U8)

**LOWER UNITS** (L1-L12)

**RECEPTION/TRANSACTION COUNTER / CARE TEAM STATION DESK** (TC1, TC2)

**UTILITY SINK AND COUNTER UNIT** (UC1)

**SHelf** (S1)

**Full-height Cabinets** (C1-C5)

**Legend:**

Category	Min. Length (mm)	Motorized Adjustable Height	Standing Height	Specialty Casework
3	3000	<input checked="" type="checkbox"/>	<input checked="" type="checkbox"/>	<input type="checkbox"/>

**FINISHES**

Full-height Cabinet:

Upper Millwork:

Countertop:

Lower Millwork:

Shelf:

Remarks:

**MECHANICAL REQUIREMENTS**

<b>PLUMBING</b> (Quantity)		Hand Hygiene Sink: <input type="text" value="1"/>	Lavatory: <input type="text"/>	Kitchen Sink: <input type="text" value="1"/>	Kitchen Sink: <input type="text"/>	Utility / Process Sink: <input type="text"/>	Scrub Sink: <input type="text"/>	Floor Sink: <input type="text"/>	Other Fixtures: <input type="checkbox"/> Shower <input type="checkbox"/> Tub <input checked="" type="checkbox"/> Ice Maker <input type="checkbox"/> Water Closet <input checked="" type="checkbox"/> Instantaneous Hot Water	<input type="checkbox"/> Ewewash Station <input type="checkbox"/> Eyewash/Shower Station <input type="checkbox"/> Emergency Shower <input type="checkbox"/> Flush Rim Sink <input type="checkbox"/> Floor Drain <input type="checkbox"/> Water Bottle Refill Station	<b>MED / NON-MED GASES</b> (Quantity)	Oxygen: <input type="text"/>	Medical Air: <input type="text"/>	Medical Vacuum: <input type="text"/>	Nitrous Oxide: <input type="text"/>	CO2: <input type="text"/>	AGSS: <input type="text"/>	Nitrogen: <input type="text"/>	Laboratory Air: <input type="text"/>	Laboratory Vacuum: <input type="text"/>	Utility Compressed Air: <input type="text"/>
Plumbing Remarks: <input type="text"/>		Gas Remarks: <input type="text"/>																			



**Appendix 1B Minimum Room Requirements**

Room Name:

Program Number(s):

1. B1.07	7.	13.	19.	25.	31.	37.	43.
2. B2.08	8.	14.	20.	26.	32.	38.	44.
3. B3.06	9.	15.	21.	27.	33.	39.	45.
4. C2.13	10.	16.	22.	28.	34.	40.	46.
5. L2.08	11.	17.	23.	29.	35.	41.	47.
6.	12.	18.	24.	30.	36.	42.	48.

**ARCHITECTURAL REQUIREMENTS**

<b>WALL AND CEILING</b> Wall Material: <input type="text" value="ARGB 1.2m AFF, GB above"/> Finish: <input type="text" value="PT"/> Ceiling Material: <input type="text" value="ACT"/> Finish: <input type="text" value="PF"/>		<b>WALL PROTECTION</b> Type: <input type="text" value="PVW"/> <input checked="" type="checkbox"/> Corner Guards <input type="checkbox"/> Hand Rails <input type="checkbox"/> Bed Bumper / Locator Height: <input type="text" value="2185 mm"/> <input checked="" type="checkbox"/> Crash Rails <input type="checkbox"/> Chair Rail		<b>GLAZING</b> <input checked="" type="checkbox"/> Interior Glazing		<b>FLOORING TYPES</b> Material: <input type="text" value="VSF"/> Base: <input type="text" value="FCB"/>		<b>ROOM ACCESSORIES</b> <input type="checkbox"/> Coat Hooks <input type="checkbox"/> Ceiling Lift <input type="checkbox"/> Magnetic Whiteboard <input type="checkbox"/> Mirror <input type="checkbox"/> Infant Change Table <input type="checkbox"/> Privacy Curtain	
--	--	--	--	--	--	--	--	--	--

- LEGEND:**
- WALL AND CEILING LEGEND:**
- AC Architectural Ceiling
  - ACT Acoustic Ceiling Tile
  - ACT-C Cleanroom
  - ARGB Abuse-Resistant Gypsum Board
  - GB Gypsum Board
  - IRGB Impact-Resistant Gypsum Board
  - KLCT Kitchen Lay-in Ceiling Tile
  - MMRGB Moisture and Mould-Resistant Gypsum Board
  - SACT Security Acoustic Ceiling Tile
- WALL FINISHES LEGEND:**
- EWC Epoxy Wall Coating
  - HPC High Performance Coating
  - PT Paint
- CEILING FINISHES LEGEND:**
- ECC Epoxy Ceiling Coating
  - HPC High Performance Coating
  - PF Prefinished
  - PT Paint
- WALL PROTECTION LEGEND:**
- ESRP Extruded Semi-Rigid PVCu Panel
  - FRL Fibre Reinforced Laminate
  - FRP Fibreglass Reinforced Plastic
  - PVW Protective Vinyl Wallcovering
  - RHIS Rigid High Impact Sheet
  - WSSP Wetwall Solid Surface Panel
  - WVV Wetroom Vinyl Wallcovering
- FLOOR FINISHES LEGEND:**
- CFS Concrete Floor Sealer
  - EFC Epoxy Floor Coating
  - PFC Polyurethane Floor Coating
  - RAF Rubber Athletic Flooring
  - RSF Rubber Sheet Flooring
  - SCF Seamless Cushioned Flooring
  - SDRF Static-Dissipative Rubber Sheet Flooring
  - SDVF Static-Dissipative Vinyl Sheet Flooring
  - VSF Vinyl Sheet Flooring
  - WSVF Wetroom Safety Vinyl Sheet Flooring
- FLOOR BASE LEGEND:**
- FCB Flash Cove Base
  - RB Rubber Base
  - SCF Seamless Cushioned Flooring

**DOORS**

Types:

Type	Qty	Size (mm)	Material	Finish	Side Lt.	Blinds	Protect.	Privacy Film	Function	Card Reader	Mag Lock	Auto Opener	Hold Open	Hinges	Accessory 1	Accessory 2	Accessory 3	Closer

Door Remarks:  Security Grille  Anti-barricade strategy

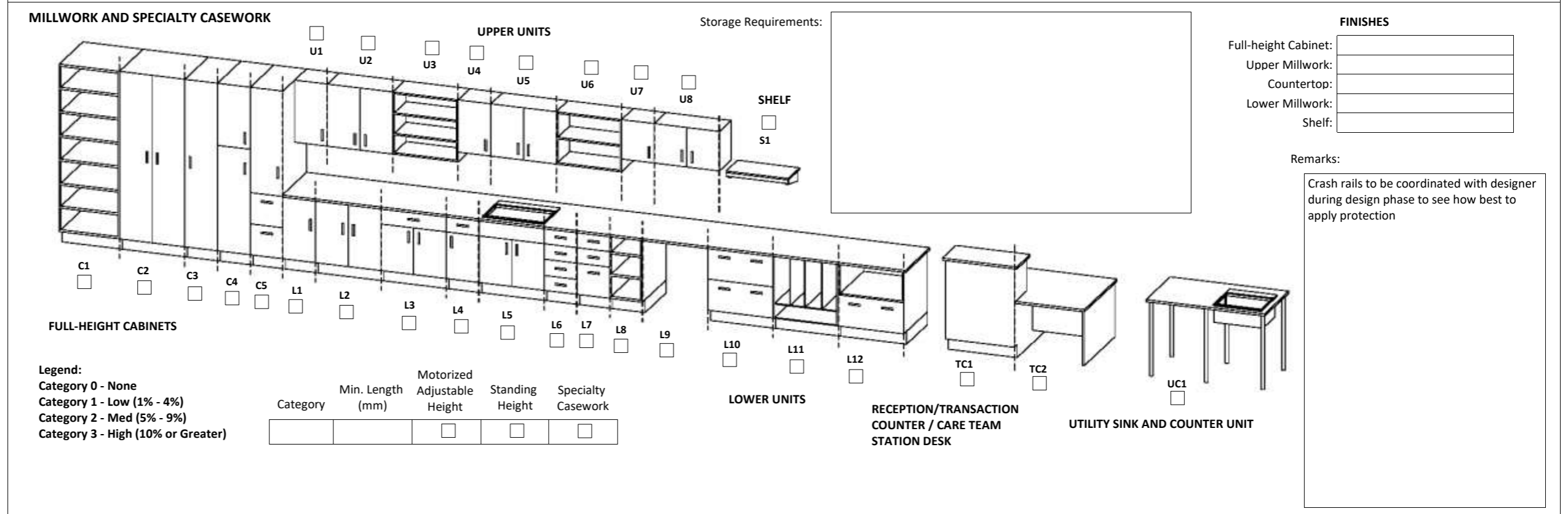

**MECHANICAL REQUIREMENTS**

<b>PLUMBING</b> (Quantity) Hand Hygiene Sink: <input type="text"/> Lavatory: <input type="text"/> Kitchen Sink: <input type="text"/> Seamless Kitchen Sink: <input type="text"/> Utility / Process Sink: <input type="text"/> Scrub Sink: <input type="text"/> Floor Sink: <input type="text"/>							Other Fixtures: <input type="checkbox"/> Shower <input type="checkbox"/> Eyewash Station <input type="checkbox"/> Tub <input type="checkbox"/> Eyewash/Shower Station <input type="checkbox"/> Ice Maker <input type="checkbox"/> Emergency Shower <input type="checkbox"/> Water Closet <input type="checkbox"/> Flush Rim Sink <input type="checkbox"/> Instantaneous Hot Water <input type="checkbox"/> Floor Drain <input type="checkbox"/> Water Bottle Refill Station				<b>MED / NON-MED GASES</b> (Quantity) Oxygen: <input type="text"/> Medical Air: <input type="text"/> Medical Vacuum: <input type="text"/> Nitrous Oxide: <input type="text"/> CO2: <input type="text"/> AGSS: <input type="text"/> Nitrogen: <input type="text"/> Laboratory Air: <input type="text"/> Laboratory Vacuum: <input type="text"/> Utility Compressed Air: <input type="text"/>				
Plumbing Remarks: <input type="text"/>							Gas Remarks: <input type="text"/>								

**Appendix 1B Minimum Room Requirements**

Room Name:

Program Number(s):

1. D2.25	7.	13.	19.	25.	31.	37.	43.
2. D3.10	8.	14.	20.	26.	32.	38.	44.
3. F7.05	9.	15.	21.	27.	33.	39.	45.
4.	10.	16.	22.	28.	34.	40.	46.
5.	11.	17.	23.	29.	35.	41.	47.
6.	12.	18.	24.	30.	36.	42.	48.

**ARCHITECTURAL REQUIREMENTS**

<b>WALL AND CEILING</b> Wall Material: <input type="text" value="ARGB 1.2m AFF, GB above"/> Finish: <input type="text" value="PT"/> Ceiling Material: <input type="text" value="ACT"/> Finish: <input type="text" value="PF"/>		<b>WALL PROTECTION</b> Type: <input type="text" value="PVW"/> <input checked="" type="checkbox"/> Corner Guards <input type="checkbox"/> Hand Rails <input type="checkbox"/> Bed Bumper / Locator Height: <input type="text" value="2185 mm"/> <input checked="" type="checkbox"/> Crash Rails <input type="checkbox"/> Chair Rail		<b>GLAZING</b> <input type="checkbox"/> Interior Glazing		<b>FLOORING TYPES</b> Material: <input type="text" value="VSF"/> Base: <input type="text" value="FCB"/>		<b>ROOM ACCESSORIES</b> <input type="checkbox"/> Coat Hooks <input type="checkbox"/> Ceiling Lift <input type="checkbox"/> Magnetic Whiteboard <input type="checkbox"/> Mirror <input type="checkbox"/> Infant Change Table <input type="checkbox"/> Privacy Curtain	
--	--	--	--	---	--	--	--	--	--

- LEGEND:**
- WALL AND CEILING LEGEND:**
- AC Architectural Ceiling
  - ACT Acoustic Ceiling Tile
  - ACT-C Cleanroom
  - ARGB Abuse-Resistant Gypsum Board
  - GB Gypsum Board
  - IRGB Impact-Resistant Gypsum Board
  - KLCT Kitchen Lay-in Ceiling Tile
  - MMRGB Moisture and Mould-Resistant Gypsum Board
  - SACT Security Acoustic Ceiling Tile
- WALL FINISHES LEGEND:**
- EWC Epoxy Wall Coating
  - HPC High Performance Coating
  - PT Paint
- CEILING FINISHES LEGEND:**
- ECC Epoxy Ceiling Coating
  - HPC High Performance Coating
  - PF Prefinished
  - PT Paint
- WALL PROTECTION LEGEND:**
- ESRP Extruded Semi-Rigid PVCu Panel
  - FRL Fibre Reinforced Laminate
  - FRP Fibreglass Reinforced Plastic
  - PVW Protective Vinyl Wallcovering
  - RHIS Rigid High Impact Sheet
  - WSSP Wetwall Solid Surface Panel
  - WVV Wetroom Vinyl Wallcovering
- FLOOR FINISHES LEGEND:**
- CFS Concrete Floor Sealer
  - EFC Epoxy Floor Coating
  - PFC Polyurethane Floor Coating
  - RAF Rubber Athletic Flooring
  - RSF Rubber Sheet Flooring
  - SCF Seamless Cushioned Flooring
  - SDRF Static-Dissipative Rubber Sheet Flooring
  - SDVF Static-Dissipative Vinyl Sheet Flooring
  - VSF Vinyl Sheet Flooring
  - WSVF Wetroom Safety Vinyl Sheet Flooring
- FLOOR BASE LEGEND:**
- FCB Flash Cove Base
  - RB Rubber Base
  - SCF Seamless Cushioned Flooring

**DOORS**

Types:

Type:Qty:	Size (mm):	Material:	Finish:	Side Lt:	Blinds:	Protect.:	Film:	Function:	Card Reader:	Mag Lock:	Auto Opener:	Hold Open:	Hinges:	Accessory 1:	Accessory 2:	Accessory 3:	Closer:

Door Remarks:  Security Grille  Anti-barricade strategy

**MILLWORK AND SPECIALTY CASEWORK**

Storage Requirements:

**UPPER UNITS** (U1-U8)

**LOWER UNITS** (L1-L12)

**RECEPTION/TRANSACTION COUNTER / CARE TEAM STATION DESK** (TC1, TC2)

**UTILITY SINK AND COUNTER UNIT** (UC1)

**SHELF** (S1)

**FULL-HEIGHT CABINETS** (C1-C5)

**Legend:**

Category	Min. Length (mm)	Motorized Adjustable Height	Standing Height	Specialty Casework
Category 0 - None				
Category 1 - Low (1% - 4%)				
Category 2 - Med (5% - 9%)				
Category 3 - High (10% or Greater)				

**FINISHES**

Full-height Cabinet:

Upper Millwork:

Countertop:

Lower Millwork:

Shelf:

Remarks: Refer to Schedule 1, Section 6.11 (Division 11) for Medical Gas Racks.

**MECHANICAL REQUIREMENTS**

<b>PLUMBING</b> (Quantity) Hand Hygiene Sink: <input type="text"/> Lavatory: <input type="text"/> Kitchen Sink: <input type="text"/> Seamless Kitchen Sink: <input type="text"/> Utility / Process Sink: <input type="text"/> Scrub Sink: <input type="text"/> Floor Sink: <input type="text"/>							Other Fixtures: <input type="checkbox"/> Shower <input type="checkbox"/> Eyewash Station <input type="checkbox"/> Tub <input type="checkbox"/> Eyewash/Shower Station <input type="checkbox"/> Ice Maker <input type="checkbox"/> Emergency Shower <input type="checkbox"/> Water Closet <input type="checkbox"/> Flush Rim Sink <input type="checkbox"/> Instantaneous Hot Water <input type="checkbox"/> Floor Drain <input type="checkbox"/> Water Bottle Refill Station Other <input type="text"/>			<b>MED / NON-MED GASES</b> (Quantity) Oxygen: <input type="text"/> Medical Air: <input type="text"/> Medical Vacuum: <input type="text"/> Nitrous Oxide: <input type="text"/> CO2: <input type="text"/> AGSS: <input type="text"/> Nitrogen: <input type="text"/> Laboratory Air: <input type="text"/> Laboratory Vacuum: <input type="text"/> Utility Compressed Air: <input type="text"/>				
Plumbing Remarks: <input type="text"/>							Gas Remarks: <input type="text"/>							

**Appendix 1B Minimum Room Requirements**

Room Name:

Program Number(s):

1. D2.14	7.	13.	19.	25.	31.	37.	43.
2. E1.01.02	8.	14.	20.	26.	32.	38.	44.
3. E4.01.02	9.	15.	21.	27.	33.	39.	45.
4. R2.04	10.	16.	22.	28.	34.	40.	46.
5. R3.01	11.	17.	23.	29.	35.	41.	47.
6.	12.	18.	24.	30.	36.	42.	48.

**ARCHITECTURAL REQUIREMENTS**

<b>WALL AND CEILING</b> Wall Material: <input type="text" value="ARGB 1.2m AFF, GB above"/> Finish: <input type="text" value="PT"/> Ceiling Material: <input type="text" value="ACT"/> Finish: <input type="text" value="PF"/>		<b>WALL PROTECTION</b> Type: <input type="text" value="PVW"/> <input checked="" type="checkbox"/> Corner Guards <input type="checkbox"/> Hand Rails <input type="checkbox"/> Bed Bumper / Locator Height: <input type="text" value="2185 mm"/> <input type="checkbox"/> Crash Rails <input type="checkbox"/> Chair Rail		<b>GLAZING</b> <input type="checkbox"/> Interior Glazing		<b>FLOORING TYPES</b> Material: <input type="text" value="VSF"/> Base: <input type="text" value="FCB"/>		<b>ROOM ACCESSORIES</b> <input type="checkbox"/> Coat Hooks <input type="checkbox"/> Ceiling Lift <input type="checkbox"/> Magnetic Whiteboard <input type="checkbox"/> Mirror <input type="checkbox"/> Infant Change Table <input type="checkbox"/> Privacy Curtain	
--	--	---	--	---	--	--	--	--	--

- LEGEND:**
- WALL AND CEILING LEGEND:**
- AC Architectural Ceiling
  - ACT Acoustic Ceiling Tile
  - ACT-C Cleanroom
  - ARGB Abuse-Resistant Gypsum Board
  - GB Gypsum Board
  - IRGB Impact-Resistant Gypsum Board
  - KLCT Kitchen Lay-in Ceiling Tile
  - MMRGB Moisture and Mould-Resistant Gypsum Board
  - SACT Security Acoustic Ceiling Tile
- WALL FINISHES LEGEND:**
- EWC Epoxy Wall Coating
  - HPC High Performance Coating
  - PT Paint
- CEILING FINISHES LEGEND:**
- ECC Epoxy Ceiling Coating
  - HPC High Performance Coating
  - PF Prefinished
  - PT Paint
- WALL PROTECTION LEGEND:**
- ESRP Extruded Semi-Rigid PVCu Panel
  - FRL Fibre Reinforced Laminate
  - FRP Fibreglass Reinforced Plastic
  - PVW Protective Vinyl Wallcovering
  - RHIS Rigid High Impact Sheet
  - WSSP Wetwall Solid Surface Panel
  - WVV Wetroom Vinyl Wallcovering
- FLOOR FINISHES LEGEND:**
- CFS Concrete Floor Sealer
  - EFC Epoxy Floor Coating
  - PFC Polyurethane Floor Coating
  - RAF Rubber Athletic Flooring
  - RSF Rubber Sheet Flooring
  - SCF Seamless Cushioned Flooring
  - SDRF Static-Dissipative Rubber Sheet Flooring
  - SDVF Static-Dissipative Vinyl Sheet Flooring
  - VSF Vinyl Sheet Flooring
  - WSVF Wetroom Safety Vinyl Sheet Flooring
- FLOOR BASE LEGEND:**
- FCB Flash Cove Base
  - RB Rubber Base
  - SCF Seamless Cushioned Flooring

**DOORS**

Types:

Type	Qty	Size (mm)	Material	Finish	Side Lt.	Blinds	Protect.	Privacy Film	Function	Card Reader	Mag Lock	Auto Opener	Hold Open	Hinges	Accessory 1	Accessory 2	Accessory 3	Closer

Door Remarks:  Security Grille  Anti-barricade strategy

**MILLWORK AND SPECIALTY CASEWORK**

Storage Requirements:

**UPPER UNITS** (U1-U8)

**LOWER UNITS** (L1-L12)

**RECEPTION/TRANSACTION COUNTER / CARE TEAM STATION DESK** (TC1, TC2)

**UTILITY SINK AND COUNTER UNIT** (UC1)

**SHELF** (S1)

**FULL-HEIGHT CABINETS** (C1-C5)

**Legend:**

Category	Min. Length (mm)	Motorized Adjustable Height	Standing Height	Specialty Casework
Category 0 - None				
Category 1 - Low (1% - 4%)				
Category 2 - Med (5% - 9%)				
Category 3 - High (10% or Greater)				

**FINISHES**

Full-height Cabinet:

Upper Millwork:

Countertop:

Lower Millwork:

Shelf:

Remarks: Refer to Schedule 1, Section 6.6 (Division 6) for Pneumatic Tube Station requirements. Provide millwork adjacent to the pneumatic tube station

**MECHANICAL REQUIREMENTS**

<b>PLUMBING</b> (Quantity) Hygiene Sink: <input type="text"/> Lavatory: <input type="text"/> Kitchen Sink: <input type="text"/> Kitchen Sink: <input type="text"/> Utility / Process Sink: <input type="text"/> Scrub Sink: <input type="text"/> Floor Sink: <input type="text"/>							Other Fixtures: <input type="checkbox"/> Shower <input type="checkbox"/> Eyewash Station <input type="checkbox"/> Tub <input type="checkbox"/> Eyewash/Shower Station <input type="checkbox"/> Ice Maker <input type="checkbox"/> Emergency Shower <input type="checkbox"/> Water Closet <input type="checkbox"/> Flush Rim Sink <input type="checkbox"/> Instantaneous Hot Water <input type="checkbox"/> Floor Drain <input type="checkbox"/> Water Bottle Refill Station				<b>MED / NON-MED GASES</b> (Quantity) Oxygen: <input type="text"/> Medical Air: <input type="text"/> Medical Vacuum: <input type="text"/> Nitrous Oxide: <input type="text"/> CO2: <input type="text"/> AGSS: <input type="text"/> Nitrogen: <input type="text"/> Laboratory Air: <input type="text"/> Laboratory Vacuum: <input type="text"/> Utility Compressed Air: <input type="text"/>				
Plumbing Remarks: <input type="text"/>							Gas Remarks: <input type="text"/>								



**Appendix 1B Minimum Room Requirements**

Room Name:

Program Number(s):

1. C3.01	7. R2.01	13.	19.	25.	31.	37.	43.
2. D4.01.02	8.	14.	20.	26.	32.	38.	44.
3. E1.01.03	9.	15.	21.	27.	33.	39.	45.
4. E3.01.14	10.	16.	22.	28.	34.	40.	46.
5. E4.01.03	11.	17.	23.	29.	35.	41.	47.
6. Not Used	12.	18.	24.	30.	36.	42.	48.

**ARCHITECTURAL REQUIREMENTS**

<b>WALL AND CEILING</b> Wall Material: <input type="text" value="ARGB 1.2m AFF, GB above"/> Finish: <input type="text" value="PT"/> Ceiling Material: <input type="text" value="ACT"/> Finish: <input type="text" value="PF"/>		<b>WALL PROTECTION</b> Type: <input type="text" value="PVW"/> <input checked="" type="checkbox"/> Corner Guards <input type="checkbox"/> Hand Rails <input type="checkbox"/> Bed Bumper / Locator Height: <input type="text" value="2185 mm"/> <input type="checkbox"/> Crash Rails <input type="checkbox"/> Chair Rail		<b>GLAZING</b> <input type="checkbox"/> Interior Glazing		<b>FLOORING TYPES</b> Material: <input type="text" value="VSF"/> Base: <input type="text" value="FCB"/>		<b>ROOM ACCESSORIES</b> <input checked="" type="checkbox"/> Coat Hooks <input type="checkbox"/> Ceiling Lift <input type="checkbox"/> Magnetic Whiteboard <input type="checkbox"/> Mirror <input type="checkbox"/> Infant Change Table <input type="checkbox"/> Privacy Curtain	
--	--	---	--	---	--	--	--	---	--

- LEGEND:**
- WALL AND CEILING LEGEND:**
- AC Architectural Ceiling
  - ACT Acoustic Ceiling Tile
  - ACT-C Cleanroom
  - ARGB Abuse-Resistant Gypsum Board
  - GB Gypsum Board
  - IRGB Impact-Resistant Gypsum Board
  - KLCT Kitchen Lay-in Ceiling Tile
  - MMRGB Moisture and Mould-Resistant Gypsum Board
  - SACT Security Acoustic Ceiling Tile
- WALL FINISHES LEGEND:**
- EWC Epoxy Wall Coating
  - HPC High Performance Coating
  - PT Paint
- CEILING FINISHES LEGEND:**
- ECC Epoxy Ceiling Coating
  - HPC High Performance Coating
  - PF Prefinished
  - PT Paint
- WALL PROTECTION LEGEND:**
- ESRP Extruded Semi-Rigid PVCu Panel
  - FRL Fibre Reinforced Laminate
  - FRP Fibreglass Reinforced Plastic
  - PVW Protective Vinyl Wallcovering
  - RHIS Rigid High Impact Sheet
  - WSSP Wetwall Solid Surface Panel
  - WVV Wetroom Vinyl Wallcovering
- FLOOR FINISHES LEGEND:**
- CFS Concrete Floor Sealer
  - EFC Epoxy Floor Coating
  - PFC Polyurethane Floor Coating
  - RAF Rubber Athletic Flooring
  - RSF Rubber Sheet Flooring
  - SCF Seamless Cushioned Flooring
  - SDRF Static-Dissipative Rubber Sheet Flooring
  - SDVF Static-Dissipative Vinyl Sheet Flooring
  - VSF Vinyl Sheet Flooring
  - WSVF Wetroom Safety Vinyl Sheet Flooring
- FLOOR BASE LEGEND:**
- FCB Flash Cove Base
  - RB Rubber Base
  - SCF Seamless Cushioned Flooring

**DOORS**

Types:

Type	Qty	Size (mm)	Material	Finish	Side Lt.	Blinds	Protect.	Film	Function	Card Reader	Mag Lock	Auto Opener	Hold Open	Hinges	Accessory 1	Accessory 2	Accessory 3	Closer

Door Remarks:  Security Grille  Anti-barricade strategy

**MILLWORK AND SPECIALTY CASEWORK**

**UPPER UNITS** (U1-U8) **LOWER UNITS** (L1-L12) **RECEPTION/TRANSACTION COUNTER / CARE TEAM STATION DESK** (TC1-TC2) **UTILITY SINK AND COUNTER UNIT** (UC1)

Storage Requirements:

**FINISHES**

Full-height Cabinet:   
 Upper Millwork:   
 Countertop:   
 Lower Millwork:   
 Shelf:

Remarks: Provide all spaces with 2 sets of (10) coat hooks and HHS for spaces in Department E. Provide all remaining spaces with (1) coat hook.

**Legend:**

Category	Min. Length (mm)	Motorized Adjustable Height	Standing Height	Specialty Casework
Category 0 - None				
Category 1 - Low (1% - 4%)				
Category 2 - Med (5% - 9%)				
Category 3 - High (10% or Greater)				

**MECHANICAL REQUIREMENTS**

**PLUMBING** (Quantity)

Hygiene Sink:	Lavatory:	Kitchen Sink:	Seamless Kitchen Sink:	Utility / Process Sink:	Scrub Sink:	Floor Sink:

Plumbing Remarks:

**Other Fixtures:**

- Shower
- Tub
- Ice Maker
- Water Closet
- Instantaneous Hot Water
- Eyewash Station
- Eyewash/Shower Station
- Emergency Shower
- Flush Rim Sink
- Floor Drain
- Water Bottle Refill Station

Other:

**MED / NON-MED GASES** (Quantity)

Oxygen:	Medical Air:	Medical Vacuum:	Nitrous Oxide:	CO2:	AGSS:	Nitrogen:	Laboratory Air:	Laboratory Vacuum:	Utility Compressed Air:

Gas Remarks:

**Appendix 1B Minimum Room Requirements**

Room Name:

Program Number(s):

1. B2.26	7.	13.	19.	25.	31.	37.	43.
2. B3.26	8.	14.	20.	26.	32.	38.	44.
3. C8.07	9.	15.	21.	27.	33.	39.	45.
4. N3.08	10.	16.	22.	28.	34.	40.	46.
5.	11.	17.	23.	29.	35.	41.	47.
6.	12.	18.	24.	30.	36.	42.	48.

**ARCHITECTURAL REQUIREMENTS**

<b>WALL AND CEILING</b> Wall Material: <input type="text" value="ARGB 1.2m AFF, GB above"/> Finish: <input type="text" value="PT"/> Ceiling Material: <input type="text" value="ACT"/> Finish: <input type="text" value="PF"/>		<b>WALL PROTECTION</b> Type: <input type="text" value="PVW"/> <input checked="" type="checkbox"/> Corner Guards <input type="checkbox"/> Hand Rails <input type="checkbox"/> Bed Bumper / Locator Height: <input type="text" value="2185 mm"/> <input type="checkbox"/> Crash Rails <input type="checkbox"/> Chair Rail		<b>GLAZING</b> <input type="checkbox"/> Interior Glazing		<b>FLOORING TYPES</b> Material: <input type="text" value="VSF"/> Base: <input type="text" value="FCB"/>		<b>ROOM ACCESSORIES</b> <input type="checkbox"/> Coat Hooks <input type="checkbox"/> Ceiling Lift <input type="checkbox"/> Magnetic Whiteboard <input type="checkbox"/> Mirror <input type="checkbox"/> Infant Change Table <input type="checkbox"/> Privacy Curtain	
--	--	---	--	---	--	--	--	--	--

- LEGEND:**
- WALL AND CEILING LEGEND:**
- AC Architectural Ceiling
  - ACT Acoustic Ceiling Tile
  - ACT-C Cleanroom
  - ARGB Abuse-Resistant Gypsum Board
  - GB Gypsum Board
  - IRGB Impact-Resistant Gypsum Board
  - KLCT Kitchen Lay-in Ceiling Tile
  - MMRGB Moisture and Mould-Resistant Gypsum Board
  - SACT Security Acoustic Ceiling Tile
- WALL FINISHES LEGEND:**
- EWC Epoxy Wall Coating
  - HPC High Performance Coating
  - PT Paint
- CEILING FINISHES LEGEND:**
- ECC Epoxy Ceiling Coating
  - HPC High Performance Coating
  - PF Prefinished
  - PT Paint
- WALL PROTECTION LEGEND:**
- ESRP Extruded Semi-Rigid PVCu Panel
  - FRL Fibre Reinforced Laminate
  - FRP Fibreglass Reinforced Plastic
  - PVW Protective Vinyl Wallcovering
  - RHIS Rigid High Impact Sheet
  - WSSP Wetwall Solid Surface Panel
  - WVV Wetroom Vinyl Wallcovering
- FLOOR FINISHES LEGEND:**
- CFS Concrete Floor Sealer
  - EFC Epoxy Floor Coating
  - PFC Polyurethane Floor Coating
  - RAF Rubber Athletic Flooring
  - RSF Rubber Sheet Flooring
  - SCF Seamless Cushioned Flooring
  - SDRF Static-Dissipative Rubber Sheet Flooring
  - SDVF Static-Dissipative Vinyl Sheet Flooring
  - VSF Vinyl Sheet Flooring
  - WSVF Wetroom Safety Vinyl Sheet Flooring
- FLOOR BASE LEGEND:**
- FCB Flash Cove Base
  - RB Rubber Base
  - SCF Seamless Cushioned Flooring

**DOORS**

Types:

Type	Qty	Size (mm)	Material	Finish	Side Lt.	Blinds	Protect.	Privacy Film	Function	Card Reader	Mag Lock	Auto Opener	Hold Open	Hinges	Accessory 1	Accessory 2	Accessory 3	Closer

Door Remarks:  Security Grille  Anti-barricade strategy

**MILLWORK AND SPECIALTY CASEWORK**

Storage Requirements: B2.26 - (20) purse lockers  
B3.26 - (20) purse lockers  
C8.07 - (20) purse lockers  
N3.08 - (30) purse lockers

**UPPER UNITS** (U1-U8) **SHELF** (S1)

**LOWER UNITS** (L1-L12) **RECEPTION/TRANSACTION COUNTER / CARE TEAM STATION DESK** (TC1, TC2) **UTILITY SINK AND COUNTER UNIT** (UC1)

**FULL-HEIGHT CABINETS** (C1-C5)

**FINISHES**

Full-height Cabinet:   
 Upper Millwork:   
 Countertop:   
 Lower Millwork:   
 Shelf:

Remarks:

**Legend:**

Category	Min. Length (mm)	Motorized Adjustable Height	Standing Height	Specialty Casework
Category 0 - None				
Category 1 - Low (1% - 4%)				
Category 2 - Med (5% - 9%)				
Category 3 - High (10% or Greater)				

**MECHANICAL REQUIREMENTS**

**PLUMBING**

(Quantity)

Hand Hygiene Sink:	Lavatory:	Kitchen Sink:	Seamless Kitchen Sink:	Utility / Process Sink:	Scrub Sink:	Floor Sink:
<input type="text"/>	<input type="text"/>	<input type="text"/>	<input type="text"/>	<input type="text"/>	<input type="text"/>	<input type="text"/>

Plumbing Remarks:

**Other Fixtures:**

- Shower
- Tub
- Ice Maker
- Water Closet
- Instantaneous Hot Water
- Eyewash Station
- Eyewash/Shower Station
- Emergency Shower
- Flush Rim Sink
- Floor Drain
- Water Bottle Refill Station

Other:

**MED / NON-MED GASES**

(Quantity)

Oxygen:	Medical Air:	Medical Vacuum:	Nitrous Oxide:	CO2:	AGSS:	Nitrogen:	Laboratory Air:	Laboratory Vacuum:	Utility Compressed Air:
<input type="text"/>	<input type="text"/>	<input type="text"/>	<input type="text"/>	<input type="text"/>	<input type="text"/>	<input type="text"/>	<input type="text"/>	<input type="text"/>	<input type="text"/>

Gas Remarks:

**Appendix 1B Minimum Room Requirements**

Room Name:

Program Number(s):

1. D2.11	7.	13.	19.	25.	31.	37.	43.
2. D3.15	8.	14.	20.	26.	32.	38.	44.
3. F4.12	9.	15.	21.	27.	33.	39.	45.
4. F5.07	10.	16.	22.	28.	34.	40.	46.
5.	11.	17.	23.	29.	35.	41.	47.
6.	12.	18.	24.	30.	36.	42.	48.

**ARCHITECTURAL REQUIREMENTS**

<b>WALL AND CEILING</b> Wall Material: <input type="text" value="ARGB 1.2m AFF, GB above"/> Finish: <input type="text" value="PT"/> Ceiling Material: <input type="text" value="ACT"/> Finish: <input type="text" value="PF"/>		<b>WALL PROTECTION</b> Type: <input type="text" value="WVW"/> <input checked="" type="checkbox"/> Corner Guards <input type="checkbox"/> Hand Rails <input type="checkbox"/> Bed Bumper / Locator Height: <input type="text" value="2185 mm"/> <input type="checkbox"/> Crash Rails <input type="checkbox"/> Chair Rail		<b>GLAZING</b> <input checked="" type="checkbox"/> Interior Glazing		<b>FLOORING TYPES</b> Material: <input type="text" value="VSF"/> Base: <input type="text" value="FCB"/>		<b>ROOM ACCESSORIES</b> <input checked="" type="checkbox"/> Coat Hooks <input type="checkbox"/> Ceiling Lift <input type="checkbox"/> Magnetic Whiteboard <input type="checkbox"/> Mirror <input type="checkbox"/> Infant Change Table <input type="checkbox"/> Privacy Curtain	
--	--	---	--	--	--	--	--	---	--

- LEGEND:**
- WALL AND CEILING LEGEND:**
- AC Architectural Ceiling
  - ACT Acoustic Ceiling Tile
  - ACT-C Cleanroom
  - ARGB Abuse-Resistant Gypsum Board
  - GB Gypsum Board
  - IRGB Impact-Resistant Gypsum Board
  - KLCT Kitchen Lay-in Ceiling Tile
  - MMRGB Moisture and Mould-Resistant Gypsum Board
  - SACT Security Acoustic Ceiling Tile
- WALL FINISHES LEGEND:**
- EWC Epoxy Wall Coating
  - HPC High Performance Coating
  - PT Paint
- CEILING FINISHES LEGEND:**
- ECC Epoxy Ceiling Coating
  - HPC High Performance Coating
  - PF Prefinished
  - PT Paint
- WALL PROTECTION LEGEND:**
- ESRP Extruded Semi-Rigid PVCu Panel
  - FRL Fibre Reinforced Laminate
  - FRP Fibreglass Reinforced Plastic
  - PVW Protective Vinyl Wallcovering
  - RHIS Rigid High Impact Sheet
  - WSSP Wetwall Solid Surface Panel
  - WVW Wetroom Vinyl Wallcovering
- FLOOR FINISHES LEGEND:**
- CFS Concrete Floor Sealer
  - EFC Epoxy Floor Coating
  - PFC Polyurethane Floor Coating
  - RAF Rubber Athletic Flooring
  - RSF Rubber Sheet Flooring
  - SCF Seamless Cushioned Flooring
  - SDRF Static-Dissipative Rubber Sheet Flooring
  - SDVF Static-Dissipative Vinyl Sheet Flooring
  - VSF Vinyl Sheet Flooring
  - WSVF Wetroom Safety Vinyl Sheet Flooring
- FLOOR BASE LEGEND:**
- FCB Flash Cove Base
  - RB Rubber Base
  - SCF Seamless Cushioned Flooring

**DOORS**

Types:

Type	Qty	Size (mm)	Material	Finish	Side Lt.	Blinds	Protect.	Privacy Film	Function	Card Reader	Mag Lock	Auto Opener	Hold Open	Hinges	Accessory 1	Accessory 2	Accessory 3	Closer

Door Remarks:  Security Grille  Anti-barricade strategy

**MILLWORK AND SPECIALTY CASEWORK**

Storage Requirements:

**UPPER UNITS** (U1-U8) **LOWER UNITS** (L1-L12) **RECEPTION/TRANSACTION COUNTER / CARE TEAM STATION DESK** (TC1-TC2) **UTILITY SINK AND COUNTER UNIT** (UC1)

**FULL-HEIGHT CABINETS** (C1-C5)

**LEGEND:**

Category	Min. Length (mm)	Motorized Adjustable Height	Standing Height	Specialty Casework
Category 0 - None				
Category 1 - Low (1% - 4%)				
Category 2 - Med (5% - 9%)				
Category 3 - High (10% or Greater)				

**FINISHES**

Full-height Cabinet:

Upper Millwork:

Countertop:

Lower Millwork:

Shelf:

Remarks:

**MECHANICAL REQUIREMENTS**

<b>PLUMBING</b> (Quantity) Hygiene Sink: <input type="text"/> Lavatory: <input type="text"/> Kitchen Sink: <input type="text"/> Kitchen Sink: <input type="text"/> Process Sink: <input type="text"/> Scrub Sink: <input type="text" value="1"/> Floor Sink: <input type="text"/>		Other Fixtures: <input type="checkbox"/> Shower <input type="checkbox"/> Tub <input type="checkbox"/> Ice Maker <input type="checkbox"/> Water Closet <input type="checkbox"/> Instantaneous Hot Water		<input type="checkbox"/> Eyewash Station <input type="checkbox"/> Eyewash/Shower Station <input type="checkbox"/> Emergency Shower <input type="checkbox"/> Flush Rim Sink <input type="checkbox"/> Floor Drain <input type="checkbox"/> Water Bottle Refill Station		<b>MED / NON-MED GASES</b> (Quantity) Oxygen: <input type="text"/> Medical Air: <input type="text"/> Medical Vacuum: <input type="text"/> Nitrous Oxide: <input type="text"/> CO2: <input type="text"/> AGSS: <input type="text"/> Nitrogen: <input type="text"/> Laboratory Air: <input type="text"/> Laboratory Vacuum: <input type="text"/> Utility Compressed Air: <input type="text"/>	
Plumbing Remarks: D2.11 - Provide (2) scrub stations serving with (3) scrub sinks each for Operating Rooms and Isolation Operating Room and (1) Scrub station serving HDR OR with (2) sinks. D3.15 - Provide (3) scrub sinks F4.12 - Provide (2) scrub sinks F5.07 - Provide (1) scrub sink		Gas Remarks: <input type="text"/>					



**Appendix 1B Minimum Room Requirements**

Room Name:

Program Number(s):

1. C1.06	7.	13.	19.	25.	31.	37.	43.
2. F1.03	8.	14.	20.	26.	32.	38.	44.
3. T1.02.06	9.	15.	21.	27.	33.	39.	45.
4. T2.01.04	10.	16.	22.	28.	34.	40.	46.
5.	11.	17.	23.	29.	35.	41.	47.
6.	12.	18.	24.	30.	36.	42.	48.

**ARCHITECTURAL REQUIREMENTS**

<b>WALL AND CEILING</b> Wall Material: <input type="text" value="ARGB 1.2m AFF, GB above"/> Finish: <input type="text" value="PT"/> Ceiling Material: <input type="text" value="ACT"/> Finish: <input type="text" value="PF"/>	<b>WALL PROTECTION</b> Type: <input type="text" value="PVW"/> <input checked="" type="checkbox"/> Corner Guards <input type="checkbox"/> Hand Rails <input type="checkbox"/> Bed Bumper / Locator Height: <input type="text" value="2185 mm"/> <input type="checkbox"/> Crash Rails <input type="checkbox"/> Chair Rail	<b>GLAZING</b> <input checked="" type="checkbox"/> Interior Glazing	<b>FLOORING TYPES</b> Material: <input type="text" value="VSF"/> Base: <input type="text" value="FCB"/>	<b>ROOM ACCESSORIES</b> <input type="checkbox"/> Coat Hooks <input type="checkbox"/> Ceiling Lift <input type="checkbox"/> Magnetic Whiteboard <input type="checkbox"/> Mirror <input type="checkbox"/> Infant Change Table <input type="checkbox"/> Privacy Curtain
--	---	--	--	--

- LEGEND:**
- WALL AND CEILING LEGEND:**
- AC Architectural Ceiling
  - ACT Acoustic Ceiling Tile
  - ACT-C Cleanroom
  - ARGB Abuse-Resistant Gypsum Board
  - GB Gypsum Board
  - IRGB Impact-Resistant Gypsum Board
  - KLCT Kitchen Lay-in Ceiling Tile
  - MMRGB Moisture and Mould-Resistant Gypsum Board
  - SACT Security Acoustic Ceiling Tile
- WALL FINISHES LEGEND:**
- EWC Epoxy Wall Coating
  - HPC High Performance Coating
  - PT Paint
- CEILING FINISHES LEGEND:**
- ECC Epoxy Ceiling Coating
  - HPC High Performance Coating
  - PF Prefinished
  - PT Paint
- WALL PROTECTION LEGEND:**
- ESRP Extruded Semi-Rigid PVCu Panel
  - FRL Fibre Reinforced Laminate
  - FRP Fibreglass Reinforced Plastic
  - PVW Protective Vinyl Wallcovering
  - RHIS Rigid High Impact Sheet
  - WSSP Wetwall Solid Surface Panel
  - WVV Wetroom Vinyl Wallcovering
- FLOOR FINISHES LEGEND:**
- CFS Concrete Floor Sealer
  - EFC Epoxy Floor Coating
  - PFC Polyurethane Floor Coating
  - RAF Rubber Athletic Flooring
  - RSF Rubber Sheet Flooring
  - SCF Seamless Cushioned Flooring
  - SDRF Static-Dissipative Rubber Sheet Flooring
  - SDVF Static-Dissipative Vinyl Sheet Flooring
  - VSF Vinyl Sheet Flooring
  - WSVF Wetroom Safety Vinyl Sheet Flooring
- FLOOR BASE LEGEND:**
- FCB Flash Cove Base
  - RB Rubber Base
  - SCF Seamless Cushioned Flooring

**DOORS**

Types:

Type:Qty:	Size (mm):	Material:	Finish:	Side Lt:	Blinds:	Protect.:	Privacy Film:	Function:	Card Reader:	Mag Lock:	Auto Opener:	Hold Open:	Hinges:	Accessory 1:	Accessory 2:	Accessory 3:	Closer:

Door Remarks:  Security Grille  Anti-barricade strategy

**MILLWORK AND SPECIALTY CASEWORK**

**UPPER UNITS** (U1-U8) **LOWER UNITS** (L1-L12) **RECEPTION/TRANSACTION COUNTER / CARE TEAM STATION DESK** (TC1-TC2) **UTILITY SINK AND COUNTER UNIT** (UC1)

Storage Requirements:

**FINISHES**

Full-height Cabinet:   
 Upper Millwork:   
 Countertop:   
 Lower Millwork:   
 Shelf:

Remarks:

**Legend:**

Category	Min. Length (mm)	Motorized Adjustable Height	Standing Height	Specialty Casework
Category 0 - None				
Category 1 - Low (1% - 4%)				
Category 2 - Med (5% - 9%)				
Category 3 - High (10% or Greater)				

**MECHANICAL REQUIREMENTS**

<b>PLUMBING</b> (Quantity) Hand Hygiene Sink: <input type="text"/> Lavatory: <input type="text"/> Kitchen Sink: <input type="text"/> Seamless Kitchen Sink: <input type="text"/> Utility / Process Sink: <input type="text"/> Scrub Sink: <input type="text"/> Floor Sink: <input type="text"/> Plumbing Remarks: <input type="text"/>	Other Fixtures: <input type="checkbox"/> Shower <input type="checkbox"/> Tub <input type="checkbox"/> Ice Maker <input type="checkbox"/> Water Closet <input type="checkbox"/> Instantaneous Hot Water <input type="checkbox"/> Eyewash Station <input type="checkbox"/> Eyewash/Shower Station <input type="checkbox"/> Emergency Shower <input type="checkbox"/> Flush Rim Sink <input type="checkbox"/> Floor Drain <input type="checkbox"/> Water Bottle Refill Station Other: <input type="text"/>	<b>MED / NON-MED GASES</b> (Quantity) Oxygen: <input type="text"/> Medical Air: <input type="text"/> Medical Vacuum: <input type="text"/> Nitrous Oxide: <input type="text"/> CO2: <input type="text"/> AGSS: <input type="text"/> Nitrogen: <input type="text"/> Laboratory Air: <input type="text"/> Laboratory Vacuum: <input type="text"/> Utility Compressed Air: <input type="text"/> Gas Remarks: <input type="text"/>
--	--	---

**Appendix 1B Minimum Room Requirements**

Room Name:

Program Number(s):

1. F7.04	7.	13.	19.	25.	31.	37.	43.
2. W6.03	8.	14.	20.	26.	32.	38.	44.
3. W4.22	9.	15.	21.	27.	33.	39.	45.
4.	10.	16.	22.	28.	34.	40.	46.
5.	11.	17.	23.	29.	35.	41.	47.
6.	12.	18.	24.	30.	36.	42.	48.

**ARCHITECTURAL REQUIREMENTS**

<b>WALL AND CEILING</b> Wall Material: <input type="text" value="ARGB 1.2m AFF, GB above"/> Finish: <input type="text" value="PT"/> Ceiling Material: <input type="text" value="ACT"/> Finish: <input type="text" value="PF"/>		<b>WALL PROTECTION</b> Type: <input type="text" value="PVW"/> <input checked="" type="checkbox"/> Corner Guards <input type="checkbox"/> Hand Rails <input type="checkbox"/> Bed Bumper / Locator Height: <input type="text" value="1600 mm"/> <input checked="" type="checkbox"/> Crash Rails <input type="checkbox"/> Chair Rail		<b>GLAZING</b> <input type="checkbox"/> Interior Glazing		<b>FLOORING TYPES</b> Material: <input type="text" value="VSF"/> Base: <input type="text" value="FCB"/>		<b>ROOM ACCESSORIES</b> <input type="checkbox"/> Coat Hooks <input type="checkbox"/> Ceiling Lift <input type="checkbox"/> Magnetic Whiteboard <input type="checkbox"/> Mirror <input type="checkbox"/> Infant Change Table <input type="checkbox"/> Privacy Curtain	
--	--	--	--	---	--	--	--	--	--

- LEGEND:**
- WALL AND CEILING LEGEND:**
- AC Architectural Ceiling
  - ACT Acoustic Ceiling Tile
  - ACT-C Cleanroom
  - ARGB Abuse-Resistant Gypsum Board
  - GB Gypsum Board
  - IRGB Impact-Resistant Gypsum Board
  - KLCT Kitchen Lay-in Ceiling Tile
  - MMRGB Moisture and Mould-Resistant Gypsum Board
  - SACT Security Acoustic Ceiling Tile
- WALL FINISHES LEGEND:**
- EWC Epoxy Wall Coating
  - HPC High Performance Coating
  - PT Paint
- CEILING FINISHES LEGEND:**
- ECC Epoxy Ceiling Coating
  - HPC High Performance Coating
  - PF Prefinished
  - PT Paint
- WALL PROTECTION LEGEND:**
- ESRP Extruded Semi-Rigid PVCu Panel
  - FRL Fibre Reinforced Laminate
  - FRP Fibreglass Reinforced Plastic
  - PVW Protective Vinyl Wallcovering
  - RHIS Rigid High Impact Sheet
  - WSSP Wetwall Solid Surface Panel
  - WVV Wetroom Vinyl Wallcovering
- FLOOR FINISHES LEGEND:**
- CFS Concrete Floor Sealer
  - EFC Epoxy Floor Coating
  - PFC Polyurethane Floor Coating
  - RAF Rubber Athletic Flooring
  - RSF Rubber Sheet Flooring
  - SCF Seamless Cushioned Flooring
  - SDRF Static-Dissipative Rubber Sheet Flooring
  - SDVF Static-Dissipative Vinyl Sheet Flooring
  - VSF Vinyl Sheet Flooring
  - WSVF Wetroom Safety Vinyl Sheet Flooring
- FLOOR BASE LEGEND:**
- FCB Flash Cove Base
  - RB Rubber Base
  - SCF Seamless Cushioned Flooring

**DOORS**

Types:

Type	Qty	Size (mm)	Material	Finish	Side Lt.	Blinds	Protect.	Privacy Film	Function	Card Reader	Mag Lock	Auto Opener	Hold Open	Hinges	Accessory 1	Accessory 2	Accessory 3	Closer

Door Remarks:  Security Grille  Anti-barricade strategy

**MILLWORK AND SPECIALTY CASEWORK**

Storage Requirements:

**UPPER UNITS** (U1-U8) **SHELF** (S1)

**FULL-HEIGHT CABINETS** (C1-C5) **LOWER UNITS** (L1-L12)

**RECEPTION/TRANSACTION COUNTER / CARE TEAM STATION DESK** (TC1, TC2)

**UTILITY SINK AND COUNTER UNIT** (UC1)

**FINISHES**

Full-height Cabinet:   
 Upper Millwork:   
 Countertop:   
 Lower Millwork:   
 Shelf:

Remarks:

**Legend:**

Category	Min. Length (mm)	Motorized Adjustable Height	Standing Height	Specialty Casework
Category 0 - None				
Category 1 - Low (1% - 4%)				
Category 2 - Med (5% - 9%)				
Category 3 - High (10% or Greater)				

**MECHANICAL REQUIREMENTS**

**PLUMBING** (Quantity)

Hand Hygiene Sink:	Lavatory:	Kitchen Sink:	Seamless Kitchen Sink:	Utility / Process Sink:	Scrub Sink:	Floor Sink:
<input type="text"/>	<input type="text"/>	<input type="text"/>	<input type="text"/>	<input type="text"/>	<input type="text"/>	<input type="text"/>

Plumbing Remarks:

**Other Fixtures:**

- Shower
- Tub
- Ice Maker
- Water Closet
- Instantaneous Hot Water
- Eyewash Station
- Eyewash/Shower Station
- Emergency Shower
- Flush Rim Sink
- Floor Drain
- Water Bottle Refill Station

Other:

**MED / NON-MED GASES** (Quantity)

Oxygen:	Medical Air:	Medical Vacuum:	Nitrous Oxide:	CO2:	AGSS:	Nitrogen:	Laboratory Air:	Laboratory Vacuum:	Utility Compressed Air:
<input type="text"/>	<input type="text"/>	<input type="text"/>	<input type="text"/>	<input type="text"/>	<input type="text"/>	<input type="text"/>	<input type="text"/>	<input type="text"/>	<input type="text"/>

Gas Remarks:

**Appendix 1B Minimum Room Requirements**

Room Name:

Program Number(s):

1. M2.40	7.	13.	19.	25.	31.	37.	43.
2. Y1.14	8.	14.	20.	26.	32.	38.	44.
3.	9.	15.	21.	27.	33.	39.	45.
4.	10.	16.	22.	28.	34.	40.	46.
5.	11.	17.	23.	29.	35.	41.	47.
6.	12.	18.	24.	30.	36.	42.	48.

**ARCHITECTURAL REQUIREMENTS**

<b>WALL AND CEILING</b> Wall Material: <input type="text" value="ARGB 1.2m AFF, GB above"/> Finish: <input type="text" value="PT"/> Ceiling Material: <input type="text" value="ACT"/> Finish: <input type="text" value="PF"/>	<b>WALL PROTECTION</b> Type: <input type="text" value="WVW"/> <input checked="" type="checkbox"/> Corner Guards <input type="checkbox"/> Hand Rails <input type="checkbox"/> Bed Bumper / Locator Height: <input type="text" value="2185 mm"/> <input type="checkbox"/> Crash Rails <input type="checkbox"/> Chair Rail	<b>GLAZING</b> <input type="checkbox"/> Interior Glazing	<b>FLOORING TYPES</b> Material: <input type="text" value="VSF"/> Base: <input type="text" value="FCB"/>	<b>ROOM ACCESSORIES</b> <input type="checkbox"/> Coat Hooks <input type="checkbox"/> Ceiling Lift <input type="checkbox"/> Magnetic Whiteboard <input type="checkbox"/> Mirror <input type="checkbox"/> Infant Change Table <input type="checkbox"/> Privacy Curtain
--	---	---	--	--

- LEGEND:**
- WALL AND CEILING LEGEND:**
- AC Architectural Ceiling
  - ACT Acoustic Ceiling Tile
  - ACT-C Cleanroom
  - ARGB Abuse-Resistant Gypsum Board
  - GB Gypsum Board
  - IRGB Impact-Resistant Gypsum Board
  - KLCT Kitchen Lay-in Ceiling Tile
  - MMRGB Moisture and Mould-Resistant Gypsum Board
  - SACT Security Acoustic Ceiling Tile
- WALL FINISHES LEGEND:**
- EWC Epoxy Wall Coating
  - HPC High Performance Coating
  - PT Paint
- CEILING FINISHES LEGEND:**
- ECC Epoxy Ceiling Coating
  - HPC High Performance Coating
  - PF Prefinished
  - PT Paint
- WALL PROTECTION LEGEND:**
- ESRP Extruded Semi-Rigid PVCu Panel
  - FRL Fibre Reinforced Laminate
  - FRP Fibreglass Reinforced Plastic
  - PVW Protective Vinyl Wallcovering
  - RHIS Rigid High Impact Sheet
  - WSSP Wetwall Solid Surface Panel
  - WVV Wetroom Vinyl Wallcovering
- FLOOR FINISHES LEGEND:**
- CFS Concrete Floor Sealer
  - EFC Epoxy Floor Coating
  - PFC Polyurethane Floor Coating
  - RAF Rubber Athletic Flooring
  - RSF Rubber Sheet Flooring
  - SCF Seamless Cushioned Flooring
  - SDRF Static-Dissipative Rubber Sheet Flooring
  - SDVF Static-Dissipative Vinyl Sheet Flooring
  - VSF Vinyl Sheet Flooring
  - WSVF Wetroom Safety Vinyl Sheet Flooring
- FLOOR BASE LEGEND:**
- FCB Flash Cove Base
  - RB Rubber Base
  - SCF Seamless Cushioned Flooring

**DOORS**

Types:

Type	Qty	Size (mm)	Material	Finish	Side Lt	Blinds	Protect	Privacy Film	Function	Card Reader	Mag Lock	Auto Opener	Hold Open	Hinges	Accessory 1	Accessory 2	Accessory 3	Closer

Door Remarks:  Security Grille  Anti-barricade strategy

**MILLWORK AND SPECIALTY CASEWORK**

**UPPER UNITS** (U1-U8) **LOWER UNITS** (L1-L12) **RECEPTION/TRANSACTION COUNTER / CARE TEAM STATION DESK** (TC1-TC2) **UTILITY SINK AND COUNTER UNIT** (UC1)

Storage Requirements:

**FINISHES**

Full-height Cabinet:   
 Upper Millwork:   
 Countertop:   
 Lower Millwork:   
 Shelf:

Remarks:

**Legend:**

Category	Min. Length (mm)	Motorized Adjustable Height	Standing Height	Specialty Casework
Category 0 - None				
Category 1 - Low (1% - 4%)				
Category 2 - Med (5% - 9%)				
Category 3 - High (10% or Greater)				

**MECHANICAL REQUIREMENTS**

<b>PLUMBING</b> (Quantity) Hand Hygiene Sink: <input type="text"/> Lavatory: <input type="text"/> Kitchen Sink: <input type="text"/> Seamless Kitchen Sink: <input type="text"/> Utility / Process Sink: <input type="text"/> Scrub Sink: <input type="text"/> Floor Sink: <input type="text"/> Plumbing Remarks: <input type="text"/>	Other Fixtures: <input type="checkbox"/> Shower <input type="checkbox"/> Eyewash Station <input type="checkbox"/> Tub <input type="checkbox"/> Eyewash/Shower Station <input type="checkbox"/> Ice Maker <input type="checkbox"/> Emergency Shower <input type="checkbox"/> Water Closet <input type="checkbox"/> Flush Rim Sink <input type="checkbox"/> Instantaneous Hot Water <input checked="" type="checkbox"/> Floor Drain <input checked="" type="checkbox"/> Water Bottle Refill Station Other <input type="text"/>	<b>MED / NON-MED GASES</b> (Quantity) Oxygen: <input type="text"/> Medical Air: <input type="text"/> Medical Vacuum: <input type="text"/> Nitrous Oxide: <input type="text"/> CO2: <input type="text"/> AGSS: <input type="text"/> Nitrogen: <input type="text"/> Laboratory Air: <input type="text"/> Laboratory Vacuum: <input type="text"/> Utility Compressed Air: <input type="text"/> Gas Remarks: <input type="text"/>
---	---	--



**Appendix 1B Minimum Room Requirements**

Room Name:

Program Number(s):

1. B4.04	7.	13.	19.	25.	31.	37.	43.
2. G1.05	8.	14.	20.	26.	32.	38.	44.
3. I2.11	9.	15.	21.	27.	33.	39.	45.
4. L2.09	10.	16.	22.	28.	34.	40.	46.
5.	11.	17.	23.	29.	35.	41.	47.
6.	12.	18.	24.	30.	36.	42.	48.

**ARCHITECTURAL REQUIREMENTS**

<b>WALL AND CEILING</b> Wall Material: <input type="text" value="ARGB 1.2m AFF, GB above"/> Finish: <input type="text" value="PT"/> Ceiling Material: <input type="text" value="ACT"/> Finish: <input type="text" value="PF"/>		<b>WALL PROTECTION</b> Type: <input type="text" value="PVW"/> <input checked="" type="checkbox"/> Corner Guards <input type="checkbox"/> Hand Rails <input type="checkbox"/> Bed Bumper / Locator Height: <input type="text" value="2185 mm"/> <input checked="" type="checkbox"/> Crash Rails <input type="checkbox"/> Chair Rail		<b>GLAZING</b> <input type="checkbox"/> Interior Glazing		<b>FLOORING TYPES</b> Material: <input type="text" value="VSF"/> Base: <input type="text" value="FCB"/>		<b>ROOM ACCESSORIES</b> <input type="checkbox"/> Coat Hooks <input type="checkbox"/> Ceiling Lift <input type="checkbox"/> Magnetic Whiteboard <input type="checkbox"/> Mirror <input type="checkbox"/> Infant Change Table <input type="checkbox"/> Privacy Curtain	
--	--	--	--	---	--	--	--	--	--

- LEGEND:**
- WALL AND CEILING LEGEND:**
- AC Architectural Ceiling
  - ACT Acoustic Ceiling Tile
  - ACT-C Cleanroom
  - ARGB Abuse-Resistant Gypsum Board
  - GB Gypsum Board
  - IRGB Impact-Resistant Gypsum Board
  - KLCT Kitchen Lay-in Ceiling Tile
  - MMRGB Moisture and Mould-Resistant Gypsum Board
  - SACT Security Acoustic Ceiling Tile
- WALL FINISHES LEGEND:**
- EWC Epoxy Wall Coating
  - HPC High Performance Coating
  - PT Paint
- CEILING FINISHES LEGEND:**
- ECC Epoxy Ceiling Coating
  - HPC High Performance Coating
  - PF Prefinished
  - PT Paint
- WALL PROTECTION LEGEND:**
- ESRP Extruded Semi-Rigid PVCu Panel
  - FRL Fibre Reinforced Laminate
  - FRP Fibreglass Reinforced Plastic
  - PVW Protective Vinyl Wallcovering
  - RHIS Rigid High Impact Sheet
  - WSSP Wetwall Solid Surface Panel
  - WVV Wetroom Vinyl Wallcovering
- FLOOR FINISHES LEGEND:**
- CFS Concrete Floor Sealer
  - EFC Epoxy Floor Coating
  - PFC Polyurethane Floor Coating
  - RAF Rubber Athletic Flooring
  - RSF Rubber Sheet Flooring
  - SCF Seamless Cushioned Flooring
  - SDRF Static-Dissipative Rubber Sheet Flooring
  - SDVF Static-Dissipative Vinyl Sheet Flooring
  - VSF Vinyl Sheet Flooring
  - WSVF Wetroom Safety Vinyl Sheet Flooring
- FLOOR BASE LEGEND:**
- FCB Flash Cove Base
  - RB Rubber Base
  - SCF Seamless Cushioned Flooring

**DOORS**

Types:

Type:Qty:	Size (mm):	Material:	Finish:	Side Lt:	Blinds:	Protect.:	Film:	Function:	Card Reader:	Mag Lock:	Auto Opener:	Hold Open:	Hinges:	Accessory 1:	Accessory 2:	Accessory 3:	Closer:

Door Remarks:  Security Grille  Anti-barricade strategy

**MILLWORK AND SPECIALTY CASEWORK**

Storage Requirements:

**UPPER UNITS** (U1-U8) **SHELF** (S1)

**FULL-HEIGHT CABINETS** (C1-C5) **LOWER UNITS** (L1-L12) **RECEPTION/TRANSACTION COUNTER / CARE TEAM STATION DESK** (TC1-TC2) **UTILITY SINK AND COUNTER UNIT** (UC1)

Category	Min. Length (mm)	Motorized Adjustable Height	Standing Height	Specialty Casework
Category 0 - None				
Category 1 - Low (1% - 4%)				
Category 2 - Med (5% - 9%)				
Category 3 - High (10% or Greater)				

**FINISHES**

Full-height Cabinet:   
 Upper Millwork:   
 Countertop:   
 Lower Millwork:   
 Shelf:

Remarks:

**MECHANICAL REQUIREMENTS**

<b>PLUMBING</b> (Quantity) Hand Hygiene Sink: <input type="text"/> Lavatory: <input type="text"/> Kitchen Sink: <input type="text"/> Seamless Kitchen Sink: <input type="text"/> Utility / Process Sink: <input type="text"/> Scrub Sink: <input type="text"/> Floor Sink: <input type="text"/>							Other Fixtures: <input type="checkbox"/> Shower <input type="checkbox"/> Eyewash Station <input type="checkbox"/> Tub <input type="checkbox"/> Eyewash/Shower Station <input type="checkbox"/> Ice Maker <input type="checkbox"/> Emergency Shower <input type="checkbox"/> Water Closet <input type="checkbox"/> Flush Rim Sink <input type="checkbox"/> Instantaneous Hot Water <input type="checkbox"/> Floor Drain <input type="checkbox"/> Water Bottle Refill Station Other <input type="text"/>				<b>MED / NON-MED GASES</b> (Quantity) Oxygen: <input type="text"/> Medical Air: <input type="text"/> Medical Vacuum: <input type="text"/> Nitrous Oxide: <input type="text"/> CO2: <input type="text"/> AGSS: <input type="text"/> Nitrogen: <input type="text"/> Laboratory Air: <input type="text"/> Laboratory Vacuum: <input type="text"/> Utility Compressed Air: <input type="text"/>					
Plumbing Remarks: <input type="text"/>											Gas Remarks: <input type="text"/>					

**Appendix 1B Minimum Room Requirements**

Room Name:

Program Number(s):

1. A1.05	7.	13.	19.	25.	31.	37.	43.
2. C1.02	8.	14.	20.	26.	32.	38.	44.
3. T2.01.03	9.	15.	21.	27.	33.	39.	45.
4.	10.	16.	22.	28.	34.	40.	46.
5.	11.	17.	23.	29.	35.	41.	47.
6.	12.	18.	24.	30.	36.	42.	48.

**ARCHITECTURAL REQUIREMENTS**

<b>WALL AND CEILING</b> Wall Material: <input type="text" value="ARGB 1.2m AFF, GB above"/> Finish: <input type="text" value="PT"/> Ceiling Material: <input type="text" value="ACT"/> Finish: <input type="text" value="PF"/>		<b>WALL PROTECTION</b> Type: <input type="text" value="PVW"/> <input checked="" type="checkbox"/> Corner Guards <input type="checkbox"/> Hand Rails <input type="checkbox"/> Bed Bumper / Locator Height: <input type="text" value="2185 mm"/> <input checked="" type="checkbox"/> Crash Rails <input type="checkbox"/> Chair Rail		<b>GLAZING</b> <input type="checkbox"/> Interior Glazing		<b>FLOORING TYPES</b> Material: <input type="text" value="VSF"/> Base: <input type="text" value="FCB"/>		<b>ROOM ACCESSORIES</b> <input type="checkbox"/> Coat Hooks <input type="checkbox"/> Ceiling Lift <input type="checkbox"/> Magnetic Whiteboard <input type="checkbox"/> Mirror <input type="checkbox"/> Infant Change Table <input type="checkbox"/> Privacy Curtain	
--	--	--	--	---	--	--	--	--	--

- LEGEND:**
- WALL AND CEILING LEGEND:**
- AC Architectural Ceiling
  - ACT Acoustic Ceiling Tile
  - ACT-C Cleanroom
  - ARGB Abuse-Resistant Gypsum Board
  - GB Gypsum Board
  - IRGB Impact-Resistant Gypsum Board
  - KLCT Kitchen Lay-in Ceiling Tile
  - MMRGB Moisture and Mould-Resistant Gypsum Board
  - SACT Security Acoustic Ceiling Tile
- WALL FINISHES LEGEND:**
- EWC Epoxy Wall Coating
  - HPC High Performance Coating
  - PT Paint
- CEILING FINISHES LEGEND:**
- ECC Epoxy Ceiling Coating
  - HPC High Performance Coating
  - PF Prefinished
  - PT Paint
- WALL PROTECTION LEGEND:**
- ESRP Extruded Semi-Rigid PVCu Panel
  - FRL Fibre Reinforced Laminate
  - FRP Fibreglass Reinforced Plastic
  - PVW Protective Vinyl Wallcovering
  - RHIS Rigid High Impact Sheet
  - WSSP Wetwall Solid Surface Panel
  - WVV Wetroom Vinyl Wallcovering
- FLOOR FINISHES LEGEND:**
- CFS Concrete Floor Sealer
  - EFC Epoxy Floor Coating
  - PFC Polyurethane Floor Coating
  - RAF Rubber Athletic Flooring
  - RSF Rubber Sheet Flooring
  - SCF Seamless Cushioned Flooring
  - SDRF Static-Dissipative Rubber Sheet Flooring
  - SDVF Static-Dissipative Vinyl Sheet Flooring
  - VSF Vinyl Sheet Flooring
  - WSVF Wetroom Safety Vinyl Sheet Flooring
- FLOOR BASE LEGEND:**
- FCB Flash Cove Base
  - RB Rubber Base
  - SCF Seamless Cushioned Flooring

**DOORS**

Types:

Type	Qty	Size (mm)	Material	Finish	Side Lt.	Blinds	Protect.	Privacy Film	Function	Card Reader	Mag Lock	Auto Opener	Hold Open	Hinges	Accessory 1	Accessory 2	Accessory 3	Closer

Door Remarks:  Security Grille  Anti-barricade strategy

**MILLWORK AND SPECIALTY CASEWORK**

Storage Requirements:

**UPPER UNITS** (U1-U8) **SHELF** (S1)

**FULL-HEIGHT CABINETS** (C1-C5) **LOWER UNITS** (L1-L12)

**RECEPTION/TRANSACTION COUNTER / CARE TEAM STATION DESK** (TC1, TC2)

**UTILITY SINK AND COUNTER UNIT** (UC1)

**FINISHES**

Full-height Cabinet:   
 Upper Millwork:   
 Countertop:   
 Lower Millwork:   
 Shelf:

Remarks:

**Legend:**

Category	Min. Length (mm)	Motorized Adjustable Height	Standing Height	Specialty Casework
Category 0 - None				
Category 1 - Low (1% - 4%)				
Category 2 - Med (5% - 9%)				
Category 3 - High (10% or Greater)				

**MECHANICAL REQUIREMENTS**

<b>PLUMBING</b> (Quantity) Hand Hygiene Sink: <input type="text"/> Lavatory: <input type="text"/> Kitchen Sink: <input type="text"/> Seamless Kitchen Sink: <input type="text"/> Utility / Process Sink: <input type="text"/> Scrub Sink: <input type="text"/> Floor Sink: <input type="text"/>		Other Fixtures: <input type="checkbox"/> Shower <input type="checkbox"/> Eyewash Station <input type="checkbox"/> Tub <input type="checkbox"/> Eyewash/Shower Station <input type="checkbox"/> Ice Maker <input type="checkbox"/> Emergency Shower <input type="checkbox"/> Water Closet <input type="checkbox"/> Flush Rim Sink <input type="checkbox"/> Instantaneous Hot Water <input type="checkbox"/> Floor Drain <input type="checkbox"/> Water Bottle Refill Station Other: <input type="text"/>		<b>MED / NON-MED GASES</b> (Quantity) Oxygen: <input type="text"/> Medical Air: <input type="text"/> Medical Vacuum: <input type="text"/> Nitrous Oxide: <input type="text"/> CO2: <input type="text"/> AGSS: <input type="text"/> Nitrogen: <input type="text"/> Laboratory Air: <input type="text"/> Laboratory Vacuum: <input type="text"/> Utility Compressed Air: <input type="text"/>	
Plumbing Remarks: <input type="text"/>		Gas Remarks: <input type="text"/>			

**Appendix 1B Minimum Room Requirements**

Room Name:

Program Number(s):

1. A2.10	7.	13.	19.	25.	31.	37.	43.
2. A3.15	8.	14.	20.	26.	32.	38.	44.
3. C3.23	9.	15.	21.	27.	33.	39.	45.
4. C4.19	10.	16.	22.	28.	34.	40.	46.
5. C5.03	11.	17.	23.	29.	35.	41.	47.
6.	12.	18.	24.	30.	36.	42.	48.

**ARCHITECTURAL REQUIREMENTS**

<b>WALL AND CEILING</b> Wall Material: <input type="text" value="ARGB 1.2m AFF, GB above"/> Finish: <input type="text" value="PT"/> Ceiling Material: <input type="text" value="ACT"/> Finish: <input type="text" value="PF"/>		<b>WALL PROTECTION</b> Type: <input type="text" value="PVW"/> <input checked="" type="checkbox"/> Corner Guards <input type="checkbox"/> Hand Rails <input type="checkbox"/> Bed Bumper / Locator Height: <input type="text" value="2185 mm"/> <input checked="" type="checkbox"/> Crash Rails <input type="checkbox"/> Chair Rail		<b>GLAZING</b> <input type="checkbox"/> Interior Glazing		<b>FLOORING TYPES</b> Material: <input type="text" value="VSF"/> Base: <input type="text" value="FCB"/>		<b>ROOM ACCESSORIES</b> <input type="checkbox"/> Coat Hooks <input type="checkbox"/> Ceiling Lift <input type="checkbox"/> Magnetic Whiteboard <input type="checkbox"/> Mirror <input type="checkbox"/> Infant Change Table <input type="checkbox"/> Privacy Curtain	
--	--	--	--	---	--	--	--	--	--

- LEGEND:**
- WALL AND CEILING LEGEND:**
- AC Architectural Ceiling
  - ACT Acoustic Ceiling Tile
  - ACT-C Cleanroom
  - ARGB Abuse-Resistant Gypsum Board
  - GB Gypsum Board
  - IRGB Impact-Resistant Gypsum Board
  - KLCT Kitchen Lay-in Ceiling Tile
  - MMRGB Moisture and Mould-Resistant Gypsum Board
  - SACT Security Acoustic Ceiling Tile
- WALL FINISHES LEGEND:**
- EWC Epoxy Wall Coating
  - HPC High Performance Coating
  - PT Paint
- CEILING FINISHES LEGEND:**
- ECC Epoxy Ceiling Coating
  - HPC High Performance Coating
  - PF Prefinished
  - PT Paint
- WALL PROTECTION LEGEND:**
- ESRP Extruded Semi-Rigid PVCu Panel
  - FRL Fibre Reinforced Laminate
  - FRP Fibreglass Reinforced Plastic
  - PVW Protective Vinyl Wallcovering
  - RHIS Rigid High Impact Sheet
  - WSSP Wetwall Solid Surface Panel
  - WVV Wetroom Vinyl Wallcovering
- FLOOR FINISHES LEGEND:**
- CFS Concrete Floor Sealer
  - EFC Epoxy Floor Coating
  - PFC Polyurethane Floor Coating
  - RAF Rubber Athletic Flooring
  - RSF Rubber Sheet Flooring
  - SCF Seamless Cushioned Flooring
  - SDRF Static-Dissipative Rubber Sheet Flooring
  - SDVF Static-Dissipative Vinyl Sheet Flooring
  - VSF Vinyl Sheet Flooring
  - WSVF Wetroom Safety Vinyl Sheet Flooring
- FLOOR BASE LEGEND:**
- FCB Flash Cove Base
  - RB Rubber Base
  - SCF Seamless Cushioned Flooring

**DOORS**

Types:

Type	Qty	Size (mm)	Material	Finish	Side Lt	Blinds	Protect	Privacy Film	Function	Card Reader	Mag Lock	Auto Opener	Hold Open	Hinges	Accessory 1	Accessory 2	Accessory 3	Closer

Door Remarks:  Security Grille  Anti-barricade strategy

**MILLWORK AND SPECIALTY CASEWORK**

Storage Requirements:

**UPPER UNITS** (U1-U8) **SHELF** (S1)

**FULL-HEIGHT CABINETS** (C1-C5) **LOWER UNITS** (L1-L12) **RECEPTION/TRANSACTION COUNTER / CARE TEAM STATION DESK** (TC1-TC2) **UTILITY SINK AND COUNTER UNIT** (UC1)

Category	Min. Length (mm)	Motorized Adjustable Height	Standing Height	Specialty Casework
Category 0 - None				
Category 1 - Low (1% - 4%)				
Category 2 - Med (5% - 9%)				
Category 3 - High (10% or Greater)				

**FINISHES**

Full-height Cabinet:   
 Upper Millwork:   
 Countertop:   
 Lower Millwork:   
 Shelf:

Remarks:

**MECHANICAL REQUIREMENTS**

<b>PLUMBING</b> (Quantity) Hand Hygiene Sink: <input type="text"/> Lavatory: <input type="text"/> Kitchen Sink: <input type="text"/> Seamless Kitchen Sink: <input type="text"/> Utility / Process Sink: <input type="text"/> Scrub Sink: <input type="text"/> Floor Sink: <input type="text"/>							Other Fixtures: <input type="checkbox"/> Shower <input type="checkbox"/> Eyewash Station <input type="checkbox"/> Tub <input type="checkbox"/> Eyewash/Shower Station <input type="checkbox"/> Ice Maker <input type="checkbox"/> Emergency Shower <input type="checkbox"/> Water Closet <input type="checkbox"/> Flush Rim Sink <input type="checkbox"/> Instantaneous Hot Water <input type="checkbox"/> Floor Drain <input type="checkbox"/> Water Bottle Refill Station Other: <input type="text"/>				<b>MED / NON-MED GASES</b> (Quantity) Oxygen: <input type="text"/> Medical Air: <input type="text"/> Medical Vacuum: <input type="text"/> Nitrous Oxide: <input type="text"/> CO2: <input type="text"/> AGSS: <input type="text"/> Nitrogen: <input type="text"/> Laboratory Air: <input type="text"/> Laboratory Vacuum: <input type="text"/> Utility Compressed Air: <input type="text"/>				
Plumbing Remarks: <input type="text"/>							Gas Remarks: <input type="text"/>								



**Appendix 1B Minimum Room Requirements**

Room Name:

Program Number(s):

1. A3.06	7.	13.	19.	25.	31.	37.	43.
2. C4.10	8.	14.	20.	26.	32.	38.	44.
3. G1.27	9.	15.	21.	27.	33.	39.	45.
4. G2.07	10.	16.	22.	28.	34.	40.	46.
5. I2.09	11.	17.	23.	29.	35.	41.	47.
6. L2.06	12.	18.	24.	30.	36.	42.	48.

**ARCHITECTURAL REQUIREMENTS**

<b>WALL AND CEILING</b> Wall Material: <input type="text" value="ARGB 1.2m AFF, GB above"/> Finish: <input type="text" value="EWC"/> Ceiling Material: <input type="text" value="GB"/> Finish: <input type="text" value="ECC"/>		<b>WALL PROTECTION</b> Type: <input type="text" value="ESRP"/> <input checked="" type="checkbox"/> Corner Guards <input type="checkbox"/> Hand Rails <input type="checkbox"/> Bed Bumper / Locator Height: <input type="text" value="1350 mm"/> <input type="checkbox"/> Crash Rails <input type="checkbox"/> Chair Rail		<b>GLAZING</b> <input type="checkbox"/> Interior Glazing		<b>FLOORING TYPES</b> Material: <input type="text" value="VSF"/> Base: <input type="text" value="FCB"/>		<b>ROOM ACCESSORIES</b> <input checked="" type="checkbox"/> Coat Hooks <input type="checkbox"/> Ceiling Lift <input type="checkbox"/> Magnetic Whiteboard <input type="checkbox"/> Mirror <input type="checkbox"/> Infant Change Table <input type="checkbox"/> Privacy Curtain	
---	--	--	--	---	--	--	--	---	--

- LEGEND:**
- WALL AND CEILING LEGEND:**
- AC Architectural Ceiling
  - ACT Acoustic Ceiling Tile
  - ACT-C Cleanroom
  - ARGB Abuse-Resistant Gypsum Board
  - GB Gypsum Board
  - IRGB Impact-Resistant Gypsum Board
  - KLCT Kitchen Lay-in Ceiling Tile
  - MMRGB Moisture and Mould-Resistant Gypsum Board
  - SACT Security Acoustic Ceiling Tile
- WALL FINISHES LEGEND:**
- EWC Epoxy Wall Coating
  - HPC High Performance Coating
  - PT Paint
- CEILING FINISHES LEGEND:**
- ECC Epoxy Ceiling Coating
  - HPC High Performance Coating
  - PF Prefinished
  - PT Paint
- WALL PROTECTION LEGEND:**
- ESRP Extruded Semi-Rigid PVCu Panel
  - FRL Fibre Reinforced Laminate
  - FRP Fibreglass Reinforced Plastic
  - PVV Protective Vinyl Wallcovering
  - RHIS Rigid High Impact Sheet
  - WSSP Wetwall Solid Surface Panel
  - WVV Wetroom Vinyl Wallcovering
- FLOOR FINISHES LEGEND:**
- CFS Concrete Floor Sealer
  - EFC Epoxy Floor Coating
  - PFC Polyurethane Floor Coating
  - RAF Rubber Athletic Flooring
  - RSF Rubber Sheet Flooring
  - SCF Seamless Cushioned Flooring
  - SDRF Static-Dissipative Rubber Sheet Flooring
  - SDVF Static-Dissipative Vinyl Sheet Flooring
  - VSF Vinyl Sheet Flooring
  - WSVF Wetroom Safety Vinyl Sheet Flooring
- FLOOR BASE LEGEND:**
- FCB Flash Cove Base
  - RB Rubber Base
  - SCF Seamless Cushioned Flooring

**DOORS**

Types:

Type	Qty	Size (mm)	Material	Finish	Side Lt.	Blinds	Protect.	Privacy Film	Function	Card Reader	Mag Lock	Auto Opener	Hold Open	Hinges	Accessory 1	Accessory 2	Accessory 3	Closer
B	2	1065 x 2135	Solid Core	FRL	<input type="checkbox"/>	<input type="checkbox"/>	2 High	<input type="checkbox"/>	Push/Pull	<input type="checkbox"/>	<input type="checkbox"/>	<input type="checkbox"/>	<input checked="" type="checkbox"/>	Butt Hinge				Concealed

Door Remarks:  Security Grille  Anti-barricade strategy

**MILLWORK AND SPECIALTY CASEWORK**

**UPPER UNITS** (U1-U8) **LOWER UNITS** (L1-L12) **RECEPTION/TRANSACTION COUNTER / CARE TEAM STATION DESK** (TC1-TC2) **UTILITY SINK AND COUNTER UNIT** (UC1)

Storage Requirements:

**FINISHES**

Full-height Cabinet:   
 Upper Millwork:   
 Countertop:   
 Lower Millwork:   
 Shelf:

Remarks:

**Legend:**

Category	Min. Length (mm)	Motorized Adjustable Height	Standing Height	Specialty Casework
Category 0 - None		<input type="checkbox"/>	<input type="checkbox"/>	<input type="checkbox"/>
Category 1 - Low (1% - 4%)		<input type="checkbox"/>	<input type="checkbox"/>	<input type="checkbox"/>
Category 2 - Med (5% - 9%)		<input type="checkbox"/>	<input type="checkbox"/>	<input type="checkbox"/>
Category 3 - High (10% or Greater)		<input type="checkbox"/>	<input type="checkbox"/>	<input type="checkbox"/>

**MECHANICAL REQUIREMENTS**

<b>PLUMBING</b> (Quantity)		Hand Hygiene Sink: <input type="text" value="1"/> Lavatory: <input type="text"/> Kitchen Sink: <input type="text"/> Seamless Kitchen Sink: <input type="text"/> Utility / Process Sink: <input type="text"/> Scrub Sink: <input type="text"/> Floor Sink: <input type="text"/>							Other Fixtures: <input type="checkbox"/> Shower <input type="checkbox"/> Tub <input type="checkbox"/> Ice Maker <input type="checkbox"/> Water Closet <input type="checkbox"/> Instantaneous Hot Water				<input type="checkbox"/> Eyewash Station <input type="checkbox"/> Eyewash/Shower Station <input type="checkbox"/> Emergency Shower <input type="checkbox"/> Flush Rim Sink <input type="checkbox"/> Floor Drain <input type="checkbox"/> Water Bottle Refill Station				<b>MED / NON-MED GASES</b> (Quantity)					
Plumbing Remarks: <input type="text"/>									Other: <input type="text"/>				Oxygen: <input type="text"/> Medical Air: <input type="text"/> Medical Vacuum: <input type="text"/> Nitrous Oxide: <input type="text"/> CO2: <input type="text"/> AGSS: <input type="text"/> Nitrogen: <input type="text"/> Laboratory Air: <input type="text"/> Laboratory Vacuum: <input type="text"/> Utility Compressed Air: <input type="text"/>									
													Gas Remarks: <input type="text"/>									

**Appendix 1B Minimum Room Requirements**

Room Name:

Program Number(s):

1. B1.06	7.	13.	19.	25.	31.	37.	43.
2. B2.07	8.	14.	20.	26.	32.	38.	44.
3. B3.05	9.	15.	21.	27.	33.	39.	45.
4. C3.15	10.	16.	22.	28.	34.	40.	46.
5. D6.08	11.	17.	23.	29.	35.	41.	47.
6. G2.10	12.	18.	24.	30.	36.	42.	48.

**ARCHITECTURAL REQUIREMENTS**

<b>WALL AND CEILING</b> Wall Material: <input type="text" value="ARGB 1.2m AFF, GB above"/> Finish: <input type="text" value="EWC"/> Ceiling Material: <input type="text" value="GB"/> Finish: <input type="text" value="ECC"/>		<b>WALL PROTECTION</b> Type: <input type="text" value="ESRP"/> <input checked="" type="checkbox"/> Corner Guards <input type="checkbox"/> Hand Rails <input type="checkbox"/> Bed Bumper / Locator Height: <input type="text" value="1350 mm"/> <input type="checkbox"/> Crash Rails <input type="checkbox"/> Chair Rail		<b>GLAZING</b> <input type="checkbox"/> Interior Glazing		<b>FLOORING TYPES</b> Material: <input type="text" value="VSF"/> Base: <input type="text" value="FCB"/>		<b>ROOM ACCESSORIES</b> <input checked="" type="checkbox"/> Coat Hooks <input type="checkbox"/> Ceiling Lift <input type="checkbox"/> Magnetic Whiteboard <input type="checkbox"/> Mirror <input type="checkbox"/> Infant Change Table <input type="checkbox"/> Privacy Curtain	
---	--	--	--	---	--	--	--	---	--

- LEGEND:**
- WALL AND CEILING LEGEND:**
- AC Architectural Ceiling
  - ACT Acoustic Ceiling Tile
  - ACT-C Cleanroom
  - ARGB Abuse-Resistant Gypsum Board
  - GB Gypsum Board
  - IRGB Impact-Resistant Gypsum Board
  - KLCT Kitchen Lay-in Ceiling Tile
  - MMRGB Moisture and Mould-Resistant Gypsum Board
  - SACT Security Acoustic Ceiling Tile
- WALL FINISHES LEGEND:**
- EWC Epoxy Wall Coating
  - HPC High Performance Coating
  - PT Paint
- CEILING FINISHES LEGEND:**
- ECC Epoxy Ceiling Coating
  - HPC High Performance Coating
  - PF Prefinished
  - PT Paint
- WALL PROTECTION LEGEND:**
- ESRP Extruded Semi-Rigid PVCu Panel
  - FRL Fibre Reinforced Laminate
  - FRP Fibreglass Reinforced Plastic
  - PVV Protective Vinyl Wallcovering
  - RHIS Rigid High Impact Sheet
  - WSSP Wetwall Solid Surface Panel
  - WVV Wetroom Vinyl Wallcovering
- FLOOR FINISHES LEGEND:**
- CFS Concrete Floor Sealer
  - EFC Epoxy Floor Coating
  - PFC Polyurethane Floor Coating
  - RAF Rubber Athletic Flooring
  - RSF Rubber Sheet Flooring
  - SCF Seamless Cushioned Flooring
  - SDRF Static-Dissipative Rubber Sheet Flooring
  - SDVF Static-Dissipative Vinyl Sheet Flooring
  - VSF Vinyl Sheet Flooring
  - WSVF Wetroom Safety Vinyl Sheet Flooring
- FLOOR BASE LEGEND:**
- FCB Flash Cove Base
  - RB Rubber Base
  - SCF Seamless Cushioned Flooring

**DOORS**

Types:

Type	Qty	Size (mm)	Material	Finish	Side Lt.	Blinds	Protect.	Privacy Film	Function	Card Reader	Mag Lock	Auto Opener	Hold Open	Hinges	Accessory 1	Accessory 2	Accessory 3	Closer
B	2	1065 x 2135	Solid Core	FRL	<input type="checkbox"/>	<input type="checkbox"/>	2 High	<input type="checkbox"/>	Push/Pull	<input type="checkbox"/>	<input type="checkbox"/>	<input type="checkbox"/>	<input checked="" type="checkbox"/>	Butt Hinge				Concealed

Door Remarks:  Security Grille  Anti-barricade strategy

**MILLWORK AND SPECIALTY CASEWORK**

**UPPER UNITS** (U1-U8) **LOWER UNITS** (L1-L12) **RECEPTION/TRANSACTION COUNTER / CARE TEAM STATION DESK** (TC1-TC2) **UTILITY SINK AND COUNTER UNIT** (UC1)

Storage Requirements:

**FINISHES**

Full-height Cabinet:   
 Upper Millwork:   
 Countertop:   
 Lower Millwork:   
 Shelf:

Remarks:

**Legend:**

Category	Min. Length (mm)	Motorized Adjustable Height	Standing Height	Specialty Casework
Category 0 - None		<input type="checkbox"/>	<input type="checkbox"/>	<input type="checkbox"/>
Category 1 - Low (1% - 4%)		<input type="checkbox"/>	<input type="checkbox"/>	<input type="checkbox"/>
Category 2 - Med (5% - 9%)		<input type="checkbox"/>	<input type="checkbox"/>	<input type="checkbox"/>
Category 3 - High (10% or Greater)		<input type="checkbox"/>	<input type="checkbox"/>	<input type="checkbox"/>

**MECHANICAL REQUIREMENTS**

<b>PLUMBING</b> (Quantity)		Hand Hygiene Sink: <input type="text" value="1"/> Lavatory: <input type="text"/> Kitchen Sink: <input type="text"/> Seamless Kitchen Sink: <input type="text"/> Utility / Process Sink: <input type="text"/> Scrub Sink: <input type="text"/> Floor Sink: <input type="text"/>							Other Fixtures: <input type="checkbox"/> Shower <input type="checkbox"/> Tub <input type="checkbox"/> Ice Maker <input type="checkbox"/> Water Closet <input type="checkbox"/> Instantaneous Hot Water				<input type="checkbox"/> Eyewash Station <input type="checkbox"/> Eyewash/Shower Station <input type="checkbox"/> Emergency Shower <input type="checkbox"/> Flush Rim Sink <input type="checkbox"/> Floor Drain <input type="checkbox"/> Water Bottle Refill Station				<b>MED / NON-MED GASES</b> (Quantity)					
Plumbing Remarks: <input type="text"/>									Other: <input type="text"/>				Oxygen: <input type="text"/> Medical Air: <input type="text"/> Medical Vacuum: <input type="text"/> Nitrous Oxide: <input type="text"/> CO2: <input type="text"/> AGSS: <input type="text"/> Nitrogen: <input type="text"/> Laboratory Air: <input type="text"/> Laboratory Vacuum: <input type="text"/> Utility Compressed Air: <input type="text"/>									
													Gas Remarks: <input type="text"/>									

**Appendix 1B Minimum Room Requirements**

Room Name:

Program Number(s):

1. A1.02	7. F8.07	13. S2.01	19.	25.	31.	37.	43.
2. C1.09	8. G3.07	14. U1.05	20.	26.	32.	38.	44.
3. D1.02	9. H1.09	15. U2.03	21.	27.	33.	39.	45.
4. E7.04	10. J5.07	16. U6.03	22.	28.	34.	40.	46.
5. E8.02	11. L3.05	17. Y4.03	23.	29.	35.	41.	47.
6. F1.02	12. N3.02	18.	24.	30.	36.	42.	48.

**ARCHITECTURAL REQUIREMENTS**

<b>WALL AND CEILING</b> Wall Material: <input type="text" value="ARGB 1.2m AFF, GB above"/> Finish: <input type="text" value="PT"/> Ceiling Material: <input type="text" value="ACT"/> Finish: <input type="text" value="PF"/>		<b>WALL PROTECTION</b> Type: <input type="text" value="PVW"/> <input checked="" type="checkbox"/> Corner Guards <input type="checkbox"/> Hand Rails <input type="checkbox"/> Bed Bumper / Locator Height: <input type="text" value="1350 mm"/> <input type="checkbox"/> Crash Rails <input checked="" type="checkbox"/> Chair Rail		<b>GLAZING</b> <input checked="" type="checkbox"/> Interior Glazing		<b>FLOORING TYPES</b> Material: <input type="text" value="VSF"/> Base: <input type="text" value="RB"/>		<b>ROOM ACCESSORIES</b> <input type="checkbox"/> Coat Hooks <input type="checkbox"/> Ceiling Lift <input checked="" type="checkbox"/> Magnetic Whiteboard <input type="checkbox"/> Mirror <input type="checkbox"/> Infant Change Table <input type="checkbox"/> Privacy Curtain	
--	--	--	--	--	--	---	--	---	--

- LEGEND:**
- WALL AND CEILING LEGEND:**
- AC Architectural Ceiling
  - ACT Acoustic Ceiling Tile
  - ACT-C Cleanroom
  - ARGB Abuse-Resistant Gypsum Board
  - GB Gypsum Board
  - IRGB Impact-Resistant Gypsum Board
  - KLCT Kitchen Lay-in Ceiling Tile
  - MMRGB Moisture and Mould-Resistant Gypsum Board
  - SACT Security Acoustic Ceiling Tile
- WALL FINISHES LEGEND:**
- EWC Epoxy Wall Coating
  - HPC High Performance Coating
  - PT Paint
- CEILING FINISHES LEGEND:**
- ECC Epoxy Ceiling Coating
  - HPC High Performance Coating
  - PF Prefinished
  - PT Paint
- WALL PROTECTION LEGEND:**
- ESRP Extruded Semi-Rigid PVCu Panel
  - FRL Fibre Reinforced Laminate
  - FRP Fibreglass Reinforced Plastic
  - PVW Protective Vinyl Wallcovering
  - RHIS Rigid High Impact Sheet
  - WSSP Wetwall Solid Surface Panel
  - WVV Wetroom Vinyl Wallcovering
- FLOOR FINISHES LEGEND:**
- CFS Concrete Floor Sealer
  - EFC Epoxy Floor Coating
  - PFC Polyurethane Floor Coating
  - RAF Rubber Athletic Flooring
  - RSF Rubber Sheet Flooring
  - SCF Seamless Cushioned Flooring
  - SDRF Static-Dissipative Rubber Sheet Flooring
  - SDVF Static-Dissipative Vinyl Sheet Flooring
  - VSF Vinyl Sheet Flooring
  - WSVF Wetroom Safety Vinyl Sheet Flooring
- FLOOR BASE LEGEND:**
- FCB Flash Cove Base
  - RB Rubber Base
  - SCF Seamless Cushioned Flooring

**DOORS**

Types:

Type	Qty	Size (mm)	Material	Finish	Side Lt.	Blinds	Protect.	Privacy Film	Function	Card Reader	Mag Lock	Auto Opener	Hold Open	Hinges	Accessory 1	Accessory 2	Accessory 3	Closer
B	1	1065 x 2135	Solid Core	FRL	<input type="checkbox"/>	<input type="checkbox"/>	1 Low	<input type="checkbox"/>	Classroom	<input type="checkbox"/>	<input type="checkbox"/>	<input type="checkbox"/>	<input type="checkbox"/>	Butt Hinge				Surface

Door Remarks: Refer to Appendix 1A [Clinical Specifications and Functional Space Requirements] for open rooms that do not require a door

- Security Grille
- Anti-barricade strategy

**MILLWORK AND SPECIALTY CASEWORK**

Storage Requirements:

**UPPER UNITS** (U1-U8)

**LOWER UNITS** (L1-L12)

**RECEPTION/TRANSACTION COUNTER / CARE TEAM STATION DESK** (TC1, TC2)

**UTILITY SINK AND COUNTER UNIT** (UC1)

**FINISHES**

Full-height Cabinet:	<input type="text" value="Plastic Laminate"/>
Upper Millwork:	<input type="text" value="Plastic Laminate"/>
Countertop:	<input type="text" value="Plastic Laminate"/>
Lower Millwork:	<input type="text" value="Plastic Laminate"/>
Shelf:	<input type="text"/>

Remarks:

**MECHANICAL REQUIREMENTS**

<b>PLUMBING</b> (Quantity) Hand Hygiene Sink: <input type="text"/> Lavatory: <input type="text"/> Kitchen Sink: <input type="text"/> Seamless Kitchen Sink: <input type="text"/> Utility / Process Sink: <input type="text"/> Scrub Sink: <input type="text"/> Floor Sink: <input type="text"/>		Other Fixtures: <input type="checkbox"/> Shower <input type="checkbox"/> Eyewash Station <input type="checkbox"/> Tub <input type="checkbox"/> Eyewash/Shower Station <input type="checkbox"/> Ice Maker <input type="checkbox"/> Emergency Shower <input type="checkbox"/> Water Closet <input type="checkbox"/> Flush Rim Sink <input type="checkbox"/> Instantaneous Hot Water <input type="checkbox"/> Floor Drain <input type="checkbox"/> Water Bottle Refill Station Other: <input type="text"/>		<b>MED / NON-MED GASES</b> (Quantity) Oxygen: <input type="text"/> Medical Air: <input type="text"/> Medical Vacuum: <input type="text"/> Nitrous Oxide: <input type="text"/> CO2: <input type="text"/> AGSS: <input type="text"/> Nitrogen: <input type="text"/> Laboratory Air: <input type="text"/> Laboratory Vacuum: <input type="text"/> Utility Compressed Air: <input type="text"/>	
Plumbing Remarks: <input type="text"/>		Gas Remarks: <input type="text"/>			



**Appendix 1B Minimum Room Requirements**

Room Name:

Program Number(s):

1. A2.09	7. C4.18	13.	19.	25.	31.	37.	43.
2. A3.14	8. C5.02	14.	20.	26.	32.	38.	44.
3. B1.10	9. D6.12	15.	21.	27.	33.	39.	45.
4. B2.14	10. I2.02	16.	22.	28.	34.	40.	46.
5. B3.13	11. L2.10	17.	23.	29.	35.	41.	47.
6. C3.22	12.	18.	24.	30.	36.	42.	48.

**ARCHITECTURAL REQUIREMENTS**

<b>WALL AND CEILING</b> Wall Material: <input type="text" value="ARGB 1.2m AFF, GB above"/> Finish: <input type="text" value="PT"/> Ceiling Material: <input type="text" value="ACT"/> Finish: <input type="text" value="PF"/>		<b>WALL PROTECTION</b> Type: <input type="text" value="PVW"/> <input checked="" type="checkbox"/> Corner Guards <input type="checkbox"/> Hand Rails <input type="checkbox"/> Bed Bumper / Locator Height: <input type="text" value="1350 mm"/> <input type="checkbox"/> Crash Rails <input checked="" type="checkbox"/> Chair Rail		<b>GLAZING</b> <input checked="" type="checkbox"/> Interior Glazing		<b>FLOORING TYPES</b> Material: <input type="text" value="VSF"/> Base: <input type="text" value="FCB"/>		<b>ROOM ACCESSORIES</b> <input type="checkbox"/> Coat Hooks <input type="checkbox"/> Ceiling Lift <input checked="" type="checkbox"/> Magnetic Whiteboard <input type="checkbox"/> Mirror <input type="checkbox"/> Infant Change Table <input type="checkbox"/> Privacy Curtain	
--	--	--	--	--	--	--	--	---	--

- LEGEND:**
- WALL AND CEILING LEGEND:**
- AC Architectural Ceiling
  - ACT Acoustic Ceiling Tile
  - ACT-C Cleanroom
  - ARGB Abuse-Resistant Gypsum Board
  - GB Gypsum Board
  - IRGB Impact-Resistant Gypsum Board
  - KLCT Kitchen Lay-in Ceiling Tile
  - MMRGB Moisture and Mould-Resistant Gypsum Board
  - SACT Security Acoustic Ceiling Tile
- WALL FINISHES LEGEND:**
- EWC Epoxy Wall Coating
  - HPC High Performance Coating
  - PT Paint
- CEILING FINISHES LEGEND:**
- ECC Epoxy Ceiling Coating
  - HPC High Performance Coating
  - PF Prefinished
  - PT Paint
- WALL PROTECTION LEGEND:**
- ESRP Extruded Semi-Rigid PVCu Panel
  - FRL Fibre Reinforced Laminate
  - FRP Fibreglass Reinforced Plastic
  - PVW Protective Vinyl Wallcovering
  - RHIS Rigid High Impact Sheet
  - WSSP Wetwall Solid Surface Panel
  - WWW Wetroom Vinyl Wallcovering
- FLOOR FINISHES LEGEND:**
- CFS Concrete Floor Sealer
  - EFC Epoxy Floor Coating
  - PFC Polyurethane Floor Coating
  - RAF Rubber Athletic Flooring
  - RSF Rubber Sheet Flooring
  - SCF Seamless Cushioned Flooring
  - SDRF Static-Dissipative Rubber Sheet Flooring
  - SDVF Static-Dissipative Vinyl Sheet Flooring
  - VSF Vinyl Sheet Flooring
  - WSVF Wetroom Safety Vinyl Sheet Flooring
- FLOOR BASE LEGEND:**
- FCB Flash Cove Base
  - RB Rubber Base
  - SCF Seamless Cushioned Flooring

**DOORS**

Types:

Type:Qty:	Size (mm):	Material:	Finish:	Side Lt:	Blinds:	Protect.:	Film:	Function:	Card Reader:	Mag Lock:	Auto Opener:	Hold Open:	Hinges:	Accessory 1:	Accessory 2:	Accessory 3:	Closer:

Door Remarks:

Security Grille  
 Anti-barricade strategy

**MILLWORK AND SPECIALTY CASEWORK**

Storage Requirements:

**UPPER UNITS** (U1-U8)

**LOWER UNITS** (L1-L12)

**RECEPTION/TRANSACTION COUNTER / CARE TEAM STATION DESK** (TC1, TC2)

**UTILITY SINK AND COUNTER UNIT** (UC1)

**SHELF** (S1)

**FULL-HEIGHT CABINETS** (C1-C5)

**Legend:**

Category	Min. Length (mm)	Motorized Adjustable Height	Standing Height	Specialty Casework
3		<input checked="" type="checkbox"/>	<input type="checkbox"/>	<input checked="" type="checkbox"/>

**FINISHES**

Full-height Cabinet:

Upper Millwork:

Countertop:

Lower Millwork:

Shelf:

Remarks: Refer to Schedule 1, Section 6.12 (Division 12) for Specialty Casework and Section 5.20 Care Team Station Millwork and Healthcare Casework. Items indicated are diagrammatic, provide specialty casework appropriate for the specific and specialized functions to be performed in the space and to accommodate Equipment.

**MECHANICAL REQUIREMENTS**

<b>PLUMBING</b> (Quantity) Hand Hygiene Sink: <input type="text"/> Lavatory: <input type="text"/> Kitchen Sink: <input type="text"/> Seamless Kitchen Sink: <input type="text"/> Utility / Process Sink: <input type="text"/> Scrub Sink: <input type="text"/> Floor Sink: <input type="text"/>							Other Fixtures: <input type="checkbox"/> Shower <input type="checkbox"/> Eyewash Station <input type="checkbox"/> Tub <input type="checkbox"/> Eyewash/Shower Station <input type="checkbox"/> Ice Maker <input type="checkbox"/> Emergency Shower <input type="checkbox"/> Water Closet <input type="checkbox"/> Flush Rim Sink <input type="checkbox"/> Instantaneous Hot Water <input type="checkbox"/> Floor Drain <input type="checkbox"/> Water Bottle Refill Station Other: <input type="text"/>				<b>MED / NON-MED GASES</b> (Quantity) Oxygen: <input type="text"/> Medical Air: <input type="text"/> Medical Vacuum: <input type="text"/> Nitrous Oxide: <input type="text"/> CO2: <input type="text"/> AGSS: <input type="text"/> Nitrogen: <input type="text"/> Laboratory Air: <input type="text"/> Laboratory Vacuum: <input type="text"/> Utility Compressed Air: <input type="text"/>				
Plumbing Remarks: <input type="text"/>							Gas Remarks: <input type="text"/>								

**Appendix 1B Minimum Room Requirements**

Room Name:

Program Number(s):

1. G2.04	7.	13.	19.	25.	31.	37.	43.
2. I2.03	8.	14.	20.	26.	32.	38.	44.
3.	9.	15.	21.	27.	33.	39.	45.
4.	10.	16.	22.	28.	34.	40.	46.
5.	11.	17.	23.	29.	35.	41.	47.
6.	12.	18.	24.	30.	36.	42.	48.

**ARCHITECTURAL REQUIREMENTS**

<b>WALL AND CEILING</b> Wall Material: <input type="text" value="ARGB 1.2m AFF, GB above"/> Finish: <input type="text" value="PT"/> Ceiling Material: <input type="text" value="ACT"/> Finish: <input type="text" value="PF"/>		<b>WALL PROTECTION</b> Type: <input type="text"/> Height: <input type="text"/> <input checked="" type="checkbox"/> Corner Guards <input type="checkbox"/> Hand Rails <input type="checkbox"/> Bed Bumper / Locator <input type="checkbox"/> Crash Rails <input checked="" type="checkbox"/> Chair Rail		<b>GLAZING</b> <input checked="" type="checkbox"/> Interior Glazing		<b>FLOORING TYPES</b> Material: <input type="text" value="VSF"/> Base: <input type="text" value="FCB"/>		<b>ROOM ACCESSORIES</b> <input type="checkbox"/> Coat Hooks <input type="checkbox"/> Ceiling Lift <input checked="" type="checkbox"/> Magnetic Whiteboard <input type="checkbox"/> Mirror <input type="checkbox"/> Infant Change Table <input type="checkbox"/> Privacy Curtain	
--	--	---	--	--	--	--	--	---	--

- LEGEND:**
- WALL AND CEILING LEGEND:**
- AC Architectural Ceiling
  - ACT Acoustic Ceiling Tile
  - ACT-C Cleanroom
  - ARGB Abuse-Resistant Gypsum Board
  - GB Gypsum Board
  - IRGB Impact-Resistant Gypsum Board
  - KLCT Kitchen Lay-in Ceiling Tile
  - MMRGB Moisture and Mould-Resistant Gypsum Board
  - SACT Security Acoustic Ceiling Tile
- WALL FINISHES LEGEND:**
- EWC Epoxy Wall Coating
  - HPC High Performance Coating
  - PT Paint
- CEILING FINISHES LEGEND:**
- ECC Epoxy Ceiling Coating
  - HPC High Performance Coating
  - PF Prefinished
  - PT Paint
- WALL PROTECTION LEGEND:**
- ESRP Extruded Semi-Rigid PVCu Panel
  - FRL Fibre Reinforced Laminate
  - FRP Fibreglass Reinforced Plastic
  - PVV Protective Vinyl Wallcovering
  - RHIS Rigid High Impact Sheet
  - WSSP Wetwall Solid Surface Panel
  - WWW Wetroom Vinyl Wallcovering
- FLOOR FINISHES LEGEND:**
- CFS Concrete Floor Sealer
  - EFC Epoxy Floor Coating
  - PFC Polyurethane Floor Coating
  - RAF Rubber Athletic Flooring
  - RSF Rubber Sheet Flooring
  - SCF Seamless Cushioned Flooring
  - SDRF Static-Dissipative Rubber Sheet Flooring
  - SDVF Static-Dissipative Vinyl Sheet Flooring
  - VSF Vinyl Sheet Flooring
  - WSVF Wetroom Safety Vinyl Sheet Flooring
- FLOOR BASE LEGEND:**
- FCB Flash Cove Base
  - RB Rubber Base
  - SCF Seamless Cushioned Flooring

**DOORS**

Types:

Type:Qty:	Size (mm):	Material:	Finish:	Side Lt:	Blinds:	Protect.:	Privacy Film:	Function:	Card Reader:	Mag Lock:	Auto Opener:	Hold Open:	Hinges:	Accessory 1:	Accessory 2:	Accessory 3:	Closer:
				<input type="checkbox"/>	<input type="checkbox"/>		<input type="checkbox"/>		<input type="checkbox"/>	<input type="checkbox"/>	<input type="checkbox"/>	<input type="checkbox"/>	Butt Hinge				Surface

Door Remarks:  Security Grille  Anti-barricade strategy

**MILLWORK AND SPECIALTY CASEWORK**

Storage Requirements:

**UPPER UNITS** (U1-U8) **SHELF** (S1)

**FULL-HEIGHT CABINETS** (C1-C5, L1-L9)

**LOWER UNITS** (L10-L12) **RECEPTION/TRANSACTION COUNTER / CARE TEAM STATION DESK** (TC1, TC2) **UTILITY SINK AND COUNTER UNIT** (UC1)

Category	Min. Length (mm)	Motorized Adjustable Height	Standing Height	Specialty Casework
3		<input checked="" type="checkbox"/>	<input type="checkbox"/>	<input checked="" type="checkbox"/>

**FINISHES**

Full-height Cabinet:   
 Upper Millwork:   
 Countertop:   
 Lower Millwork:   
 Shelf:

Remarks: Refer to Schedule 1, Section 6.12 (Division 12) for Specialty Casework and Section 5.20 Care Team Station Millwork and Healthcare Casework. Items indicated are diagrammatic, provide specialty casework appropriate for the specific and specialized functions to be performed in the space and to accommodate Equipment.

**MECHANICAL REQUIREMENTS**

<b>PLUMBING</b> (Quantity) Hygiene Sink: <input type="text"/> Lavatory: <input type="text"/> Kitchen Sink: <input type="text"/> Kitchen Sink: <input type="text"/> Utility / Process Sink: <input type="text"/> Scrub Sink: <input type="text"/> Floor Sink: <input type="text"/> Plumbing Remarks: <input type="text"/>							Other Fixtures: <input type="checkbox"/> Shower <input type="checkbox"/> Tub <input type="checkbox"/> Ice Maker <input type="checkbox"/> Water Closet <input type="checkbox"/> Instantaneous Hot Water <input type="checkbox"/> Eyewash Station <input type="checkbox"/> Eyewash/Shower Station <input type="checkbox"/> Emergency Shower <input type="checkbox"/> Flush Rim Sink <input type="checkbox"/> Floor Drain <input type="checkbox"/> Water Bottle Refill Station Other: <input type="text"/>				<b>MED / NON-MED GASES</b> (Quantity) Oxygen: <input type="text"/> Medical Air: <input type="text"/> Medical Vacuum: <input type="text"/> Nitrous Oxide: <input type="text"/> CO2: <input type="text"/> AGSS: <input type="text"/> Nitrogen: <input type="text"/> Laboratory Air: <input type="text"/> Laboratory Vacuum: <input type="text"/> Utility Compressed Air: <input type="text"/> Gas Remarks: <input type="text"/>				
--	--	--	--	--	--	--	--	--	--	--	---	--	--	--	--

**Appendix 1B Minimum Room Requirements**

Room Name:

Program Number(s):

1. A2.05	7.	13.	19.	25.	31.	37.	43.
2. A3.08	8.	14.	20.	26.	32.	38.	44.
3. C4.14	9.	15.	21.	27.	33.	39.	45.
4. C5.04	10.	16.	22.	28.	34.	40.	46.
5.	11.	17.	23.	29.	35.	41.	47.
6.	12.	18.	24.	30.	36.	42.	48.

**ARCHITECTURAL REQUIREMENTS**

<b>WALL AND CEILING</b> Wall Material: <input type="text" value="ARGB 1.2m AFF, GB above"/> Finish: <input type="text" value="PT"/> Ceiling Material: <input type="text" value="ACT"/> Finish: <input type="text" value="PF"/>	<b>WALL PROTECTION</b> Type: <input type="text" value="PVW"/> <input checked="" type="checkbox"/> Corner Guards <input type="checkbox"/> Hand Rails <input type="checkbox"/> Bed Bumper / Locator Height: <input type="text" value="1600 mm"/> <input type="checkbox"/> Crash Rails <input checked="" type="checkbox"/> Chair Rail	<b>GLAZING</b> <input checked="" type="checkbox"/> Interior Glazing	<b>FLOORING TYPES</b> Material: <input type="text" value="VSV"/> Base: <input type="text" value="FCB"/>	<b>ROOM ACCESSORIES</b> <input checked="" type="checkbox"/> Coat Hooks <input checked="" type="checkbox"/> Ceiling Lift <input type="checkbox"/> Magnetic Whiteboard <input type="checkbox"/> Mirror <input type="checkbox"/> Infant Change Table <input checked="" type="checkbox"/> Privacy Curtain
--	--	--	--	---

- LEGEND:**
- WALL AND CEILING LEGEND:**
- AC Architectural Ceiling
  - ACT Acoustic Ceiling Tile
  - ACT-C Cleanroom
  - ARGB Abuse-Resistant Gypsum Board
  - GB Gypsum Board
  - IRGB Impact-Resistant Gypsum Board
  - KLCT Kitchen Lay-in Ceiling Tile
  - MMRGB Moisture and Mould-Resistant Gypsum Board
  - SACT Security Acoustic Ceiling Tile
- WALL FINISHES LEGEND:**
- EWC Epoxy Wall Coating
  - HPC High Performance Coating
  - PT Paint
- CEILING FINISHES LEGEND:**
- ECC Epoxy Ceiling Coating
  - HPC High Performance Coating
  - PF Prefinished
  - PT Paint
- WALL PROTECTION LEGEND:**
- ESRP Extruded Semi-Rigid PVCu Panel
  - FRL Fibre Reinforced Laminate
  - FRP Fibreglass Reinforced Plastic
  - PVW Protective Vinyl Wallcovering
  - RHIS Rigid High Impact Sheet
  - WSSP Wetwall Solid Surface Panel
  - WVV Wetroom Vinyl Wallcovering
- FLOOR FINISHES LEGEND:**
- CFS Concrete Floor Sealer
  - EFC Epoxy Floor Coating
  - PFC Polyurethane Floor Coating
  - RAF Rubber Athletic Flooring
  - RSF Rubber Sheet Flooring
  - SCF Seamless Cushioned Flooring
  - SDRF Static-Dissipative Rubber Sheet Flooring
  - SDVF Static-Dissipative Vinyl Sheet Flooring
  - VSV Vinyl Sheet Flooring
  - WSVF Wetroom Safety Vinyl Sheet Flooring
- FLOOR BASE LEGEND:**
- FCB Flash Cove Base
  - RB Rubber Base
  - SCF Seamless Cushioned Flooring

**DOORS**

Types:

Type	Qty	Size (mm)	Material	Finish	Side Lt.	Blinds	Protect.	Privacy Film	Function	Card Reader	Mag Lock	Auto Opener	Hold Open	Hinges	Accessory 1	Accessory 2	Accessory 3	Closer

Door Remarks:  Security Grille  Anti-barricade strategy

**MILLWORK AND SPECIALTY CASEWORK**

**UPPER UNITS** (U1-U8) **LOWER UNITS** (L1-L9)

**RECEPTION/TRANSACTION COUNTER / CARE TEAM STATION DESK** (TC1, TC2)

**UTILITY SINK AND COUNTER UNIT** (UC1)

**Storage Requirements:**  SHELF (S1)

**FINISHES**

- Full-height Cabinet:
- Upper Millwork:
- Countertop:
- Lower Millwork:
- Shelf:

Remarks: For A2.05 Chair Bay - Exam/Treatment requirements refer to Schedule 1: Future X-Y Gantry Ceiling Lift Systems. Refer to Appendix 1H [Equipment and Furniture] for ceiling lift quantities. Provide a fixed, modular partition room divider between recliners for infection control.

**MECHANICAL REQUIREMENTS**

<b>PLUMBING</b> (Quantity) Hand Hygiene Sink: <input type="text"/> Lavatory: <input type="text"/> Kitchen Sink: <input type="text"/> Seamless Kitchen Sink: <input type="text"/> Utility / Process Sink: <input type="text"/> Scrub Sink: <input type="text"/> Floor Sink: <input type="text"/>	Other Fixtures: <input type="checkbox"/> Shower <input type="checkbox"/> Eyewash Station <input type="checkbox"/> Tub <input type="checkbox"/> Eyewash/Shower Station <input type="checkbox"/> Ice Maker <input type="checkbox"/> Emergency Shower <input type="checkbox"/> Water Closet <input type="checkbox"/> Flush Rim Sink <input type="checkbox"/> Instantaneous Hot Water <input type="checkbox"/> Floor Drain <input type="checkbox"/> <input type="checkbox"/> Water Bottle Refill Station Other: <input type="text"/>	<b>MED / NON-MED GASES</b> (Quantity) Oxygen: <input type="text" value="1"/> Medical Air: <input type="text" value="1"/> Medical Vacuum: <input type="text" value="1"/> Nitrous Oxide: <input type="text"/> CO2: <input type="text"/> AGSS: <input type="text"/> Nitrogen: <input type="text"/> Laboratory Air: <input type="text"/> Laboratory Vacuum: <input type="text"/> Utility Compressed Air: <input type="text"/>
---	---	---

Plumbing Remarks: A2.05 - Provide (1) HHS near Chair Bay  
A3.08 - Provide (1) HHS to serve (3) bays  
C4.14 - Provide (1) HHS to serve (3) bays  
C5.04 - Provide (1) HHS to serve (2) bays

Gas Remarks:



**Appendix 1B Minimum Room Requirements**

Room Name:

Program Number(s):

1. C7.10	7. K3.02	13.	19.	25.	31.	37.	43.
2. F2.04	8. K4.03	14.	20.	26.	32.	38.	44.
3. F3.02	9. L1.08	15.	21.	27.	33.	39.	45.
4. F4.02	10. M2.08	16.	22.	28.	34.	40.	46.
5. F5.02	11. R3.08	17.	23.	29.	35.	41.	47.
6. F6.02	12. Y1.11	18.	24.	30.	36.	42.	48.

**ARCHITECTURAL REQUIREMENTS**

<b>WALL AND CEILING</b> Wall Material: <input type="text" value="MMRGB"/> Finish: <input type="text" value="PT"/> Ceiling Material: <input type="text" value="ACT"/> Finish: <input type="text" value="PF"/>		<b>WALL PROTECTION</b> Type: <input type="text" value="FRL"/> <input checked="" type="checkbox"/> Corner Guards <input type="checkbox"/> Hand Rails <input type="checkbox"/> Bed Bumper / Locator Height: <input type="text" value="1350 mm"/> <input type="checkbox"/> Crash Rails <input type="checkbox"/> Chair Rail		<b>GLAZING</b> <input type="checkbox"/> Interior Glazing		<b>FLOORING TYPES</b> Material: <input type="text" value="WSVF"/> Base: <input type="text" value="FCB"/>		<b>ROOM ACCESSORIES</b> <input checked="" type="checkbox"/> Coat Hooks <input type="checkbox"/> Ceiling Lift <input type="checkbox"/> Magnetic Whiteboard <input checked="" type="checkbox"/> Mirror <input type="checkbox"/> Infant Change Table <input type="checkbox"/> Privacy Curtain	
--	--	---	--	---	--	---	--	--	--

- LEGEND:**
- WALL AND CEILING LEGEND:**
- AC Architectural Ceiling
  - ACT Acoustic Ceiling Tile
  - ACT-C Cleanroom
  - ARGB Abuse-Resistant Gypsum Board
  - GB Gypsum Board
  - IRGB Impact-Resistant Gypsum Board
  - KLCT Kitchen Lay-in Ceiling Tile
  - MMRGB Moisture and Mould-Resistant Gypsum Board
  - SACT Security Acoustic Ceiling Tile
- WALL FINISHES LEGEND:**
- EWC Epoxy Wall Coating
  - HPC High Performance Coating
  - PT Paint
- CEILING FINISHES LEGEND:**
- ECC Epoxy Ceiling Coating
  - HPC High Performance Coating
  - PF Prefinished
  - PT Paint
- WALL PROTECTION LEGEND:**
- ESRP Extruded Semi-Rigid PVCu Panel
  - FRL Fibre Reinforced Laminate
  - FRP Fibreglass Reinforced Plastic
  - PVV Protective Vinyl Wallcovering
  - RHIS Rigid High Impact Sheet
  - WSSP Wetwall Solid Surface Panel
  - WVV Wetroom Vinyl Wallcovering
- FLOOR FINISHES LEGEND:**
- CFS Concrete Floor Sealer
  - EFC Epoxy Floor Coating
  - PFC Polyurethane Floor Coating
  - RAF Rubber Athletic Flooring
  - RSF Rubber Sheet Flooring
  - SCF Seamless Cushioned Flooring
  - SDRF Static-Dissipative Rubber Sheet Flooring
  - SDVF Static-Dissipative Vinyl Sheet Flooring
  - VSF Vinyl Sheet Flooring
  - WSVF Wetroom Safety Vinyl Sheet Flooring
- FLOOR BASE LEGEND:**
- FCB Flash Cove Base
  - RB Rubber Base
  - SCF Seamless Cushioned Flooring

**DOORS**

Types:

Type	Qty	Size (mm)	Material	Finish	Side Lt.	Blinds	Protect.	Film	Function	Card Reader	Mag Lock	Auto Opener	Hold Open	Hinges	Accessory 1	Accessory 2	Accessory 3	Closer
A	1	1065 x 2135	Solid Core	FRL	<input type="checkbox"/>	<input type="checkbox"/>	1 Low	<input type="checkbox"/>	Privacy	<input type="checkbox"/>	<input type="checkbox"/>	<input type="checkbox"/>	<input type="checkbox"/>	Butt Hinge				Surface

Door Remarks:  Security Grille  Anti-barricade strategy

**MILLWORK AND SPECIALTY CASEWORK**

**UPPER UNITS** (U1-U8) **LOWER UNITS** (L1-L12) **RECEPTION/TRANSACTION COUNTER / CARE TEAM STATION DESK** (TC1-TC2) **UTILITY SINK AND COUNTER UNIT** (UC1)

Storage Requirements:  SHELF  S1

Category	Min. Length (mm)	Motorized Adjustable Height	Standing Height	Specialty Casework
3	600	<input type="checkbox"/>	<input type="checkbox"/>	<input type="checkbox"/>

**FINISHES**

Full-height Cabinet:   
 Upper Millwork:   
 Countertop:   
 Lower Millwork:   
 Shelf:

Remarks:

**MECHANICAL REQUIREMENTS**

<b>PLUMBING</b> (Quantity) Hygiene Sink: <input type="text"/> Lavatory: <input type="text"/> Kitchen Sink: <input type="text"/> Kitchen Sink: <input type="text"/> Utility / Process Sink: <input type="text"/> Scrub Sink: <input type="text"/> Floor Sink: <input type="text"/> Plumbing Remarks: <input type="text"/>							Other Fixtures: <input type="checkbox"/> Shower <input type="checkbox"/> Eyewash Station <input type="checkbox"/> Tub <input type="checkbox"/> Eyewash/Shower Station <input type="checkbox"/> Ice Maker <input type="checkbox"/> Emergency Shower <input type="checkbox"/> Water Closet <input type="checkbox"/> Flush Rim Sink <input type="checkbox"/> Instantaneous Hot Water <input type="checkbox"/> Floor Drain <input type="checkbox"/> <input type="checkbox"/> Water Bottle Refill Station Other <input type="text"/>				<b>MED / NON-MED GASES</b> (Quantity) Oxygen: <input type="text"/> Medical Air: <input type="text"/> Medical Vacuum: <input type="text"/> Nitrous Oxide: <input type="text"/> CO2: <input type="text"/> AGSS: <input type="text"/> Nitrogen: <input type="text"/> Laboratory Air: <input type="text"/> Laboratory Vacuum: <input type="text"/> Utility Compressed Air: <input type="text"/> Gas Remarks: <input type="text"/>					
--	--	--	--	--	--	--	--	--	--	--	---	--	--	--	--	--

**Appendix 1B Minimum Room Requirements**

Room Name:

Program Number(s):

1. F4.22	7.	13.	19.	25.	31.	37.	43.
2. L1.20	8.	14.	20.	26.	32.	38.	44.
3. M2.35	9.	15.	21.	27.	33.	39.	45.
4.	10.	16.	22.	28.	34.	40.	46.
5.	11.	17.	23.	29.	35.	41.	47.
6.	12.	18.	24.	30.	36.	42.	48.

**ARCHITECTURAL REQUIREMENTS**

<b>WALL AND CEILING</b> Wall Material: <input type="text" value="MMRGB"/> Finish: <input type="text" value="PT"/> Ceiling Material: <input type="text" value="ACT"/> Finish: <input type="text" value="PF"/>	<b>WALL PROTECTION</b> Type: <input type="text" value="FRL"/> <input checked="" type="checkbox"/> Corner Guards <input type="checkbox"/> Hand Rails <input type="checkbox"/> Bed Bumper / Locator Height: <input type="text" value="1350 mm"/> <input type="checkbox"/> Crash Rails <input type="checkbox"/> Chair Rail	<b>GLAZING</b> <input type="checkbox"/> Interior Glazing	<b>FLOORING TYPES</b> Material: <input type="text" value="WSVF"/> Base: <input type="text" value="FCB"/>	<b>ROOM ACCESSORIES</b> <input checked="" type="checkbox"/> Coat Hooks <input type="checkbox"/> Ceiling Lift <input type="checkbox"/> Magnetic Whiteboard <input checked="" type="checkbox"/> Mirror <input type="checkbox"/> Infant Change Table <input type="checkbox"/> Privacy Curtain
--	---	---	---	--

- LEGEND:**
- WALL AND CEILING LEGEND:**
- AC Architectural Ceiling
  - ACT Acoustic Ceiling Tile
  - ACT-C Cleanroom
  - ARGB Abuse-Resistant Gypsum Board
  - GB Gypsum Board
  - IRGB Impact-Resistant Gypsum Board
  - KLCT Kitchen Lay-in Ceiling Tile
  - MMRGB Moisture and Mould-Resistant Gypsum Board
  - SACT Security Acoustic Ceiling Tile
- WALL FINISHES LEGEND:**
- EWC Epoxy Wall Coating
  - HPC High Performance Coating
  - PT Paint
- CEILING FINISHES LEGEND:**
- ECC Epoxy Ceiling Coating
  - HPC High Performance Coating
  - PF Prefinished
  - PT Paint
- WALL PROTECTION LEGEND:**
- ESRP Extruded Semi-Rigid PVCu Panel
  - FRL Fibre Reinforced Laminate
  - FRP Fibreglass Reinforced Plastic
  - PVV Protective Vinyl Wallcovering
  - RHIS Rigid High Impact Sheet
  - WSSP Wetwall Solid Surface Panel
  - WVV Wetroom Vinyl Wallcovering
- FLOOR FINISHES LEGEND:**
- CFS Concrete Floor Sealer
  - EFC Epoxy Floor Coating
  - PFC Polyurethane Floor Coating
  - RAF Rubber Athletic Flooring
  - RSF Rubber Sheet Flooring
  - SCF Seamless Cushioned Flooring
  - SDRF Static-Dissipative Rubber Sheet Flooring
  - SDVF Static-Dissipative Vinyl Sheet Flooring
  - VSF Vinyl Sheet Flooring
  - WSVF Wetroom Safety Vinyl Sheet Flooring
- FLOOR BASE LEGEND:**
- FCB Flash Cove Base
  - RB Rubber Base
  - SCF Seamless Cushioned Flooring

**DOORS**

Types:

Note: for Type F doors, the door panels will be approximately 465/1065 unless otherwise required by the Authority

Door Remarks:  Security Grille  Anti-barricade strategy

Type	Qty	Size (mm)	Material	Finish	Side Lt.	Blinds	Protect.	Film	Function	Card Reader	Mag Lock	Auto Opener	Hold Open	Hinges	Accessory 1	Accessory 2	Accessory 3	Closer
F	1	1530 x 2135	Solid Core	FRL	<input type="checkbox"/>	<input type="checkbox"/>	1 Low	<input type="checkbox"/>	Privacy	<input type="checkbox"/>	<input type="checkbox"/>	<input type="checkbox"/>	<input type="checkbox"/>	Butt Hinge	Astragal	Flush Bolt		Surface

**MILLWORK AND SPECIALTY CASEWORK**

Storage Requirements:

**UPPER UNITS** (U1-U8) **SHELF** (S1)

**LOWER UNITS** (L1-L12) **RECEPTION/TRANSACTION COUNTER / CARE TEAM STATION DESK** (TC1, TC2) **UTILITY SINK AND COUNTER UNIT** (UC1)

**FULL-HEIGHT CABINETS** (C1-C5)

**FINISHES**

Full-height Cabinet:   
 Upper Millwork:   
 Countertop:   
 Lower Millwork:   
 Shelf:

Remarks:

Category	Min. Length (mm)	Motorized Adjustable Height	Standing Height	Specialty Casework
2	600	<input type="checkbox"/>	<input type="checkbox"/>	<input type="checkbox"/>

**MECHANICAL REQUIREMENTS**

**PLUMBING** (Quantity)

Hand Hygiene Sink:	Lavatory:	Kitchen Sink:	Seamless Kitchen Sink:	Utility / Process Sink:	Scrub Sink:	Floor Sink:
<input type="text"/>	<input type="text"/>	<input type="text"/>	<input type="text"/>	<input type="text"/>	<input type="text"/>	<input type="text"/>

Plumbing Remarks:

**Other Fixtures:**

- Shower
- Tub
- Ice Maker
- Water Closet
- Instantaneous Hot Water
- Eyewash Station
- Eyewash/Shower Station
- Emergency Shower
- Flush Rim Sink
- Floor Drain
- Water Bottle Refill Station
- Other:

**MED / NON-MED GASES** (Quantity)

Oxygen:	Medical Air:	Medical Vacuum:	Nitrous Oxide:	CO2:	AGSS:	Nitrogen:	Laboratory Air:	Laboratory Vacuum:	Utility Compressed Air:
<input type="text"/>	<input type="text"/>	<input type="text"/>	<input type="text"/>	<input type="text"/>	<input type="text"/>	<input type="text"/>	<input type="text"/>	<input type="text"/>	<input type="text"/>

Gas Remarks:

**Appendix 1B Minimum Room Requirements**

Room Name:

Program Number(s):

1. W6.02	7.	13.	19.	25.	31.	37.	43.
2.	8.	14.	20.	26.	32.	38.	44.
3.	9.	15.	21.	27.	33.	39.	45.
4.	10.	16.	22.	28.	34.	40.	46.
5.	11.	17.	23.	29.	35.	41.	47.
6.	12.	18.	24.	30.	36.	42.	48.

**ARCHITECTURAL REQUIREMENTS**

<b>WALL AND CEILING</b> Wall Material: <input type="text" value="ARGB 1.2m AFF, GB above"/> Finish: <input type="text" value="PT"/> Ceiling Material: <input type="text" value="ACT"/> Finish: <input type="text" value="PF"/>	<b>WALL PROTECTION</b> Type: <input type="text" value="PVW"/> <input checked="" type="checkbox"/> Corner Guards <input type="checkbox"/> Hand Rails <input type="checkbox"/> Bed Bumper / Locator Height: <input type="text" value="2185 mm"/> <input checked="" type="checkbox"/> Crash Rails <input type="checkbox"/> Chair Rail	<b>GLAZING</b> <input type="checkbox"/> Interior Glazing	<b>FLOORING TYPES</b> Material: <input type="text" value="WSVF"/> Base: <input type="text" value="FCB"/>	<b>ROOM ACCESSORIES</b> <input type="checkbox"/> Coat Hooks <input type="checkbox"/> Ceiling Lift <input type="checkbox"/> Magnetic Whiteboard <input type="checkbox"/> Mirror <input type="checkbox"/> Infant Change Table <input type="checkbox"/> Privacy Curtain
--	--	---	---	--

- LEGEND:**
- WALL AND CEILING LEGEND:**
- AC Architectural Ceiling
  - ACT Acoustic Ceiling Tile
  - ACT-C Cleanroom
  - ARGB Abuse-Resistant Gypsum Board
  - GB Gypsum Board
  - IRGB Impact-Resistant Gypsum Board
  - KLCT Kitchen Lay-in Ceiling Tile
  - MMRGB Moisture and Mould-Resistant Gypsum Board
  - SACT Security Acoustic Ceiling Tile
- WALL FINISHES LEGEND:**
- EWC Epoxy Wall Coating
  - HPC High Performance Coating
  - PT Paint
- CEILING FINISHES LEGEND:**
- ECC Epoxy Ceiling Coating
  - HPC High Performance Coating
  - PF Prefinished
  - PT Paint
- WALL PROTECTION LEGEND:**
- ESRP Extruded Semi-Rigid PVCu Panel
  - FRL Fibre Reinforced Laminate
  - FRP Fibreglass Reinforced Plastic
  - PVW Protective Vinyl Wallcovering
  - RHIS Rigid High Impact Sheet
  - WSSP Wetwall Solid Surface Panel
  - WVV Wetroom Vinyl Wallcovering
- FLOOR FINISHES LEGEND:**
- CFS Concrete Floor Sealer
  - EFC Epoxy Floor Coating
  - PFC Polyurethane Floor Coating
  - RAF Rubber Athletic Flooring
  - RSF Rubber Sheet Flooring
  - SCF Seamless Cushioned Flooring
  - SDRF Static-Dissipative Rubber Sheet Flooring
  - SDVF Static-Dissipative Vinyl Sheet Flooring
  - VSF Vinyl Sheet Flooring
  - WSVF Wetroom Safety Vinyl Sheet Flooring
- FLOOR BASE LEGEND:**
- FCB Flash Cove Base
  - RB Rubber Base
  - SCF Seamless Cushioned Flooring

**DOORS**

Types:

Type	Qty	Size (mm)	Material	Finish	Side Lt.	Blinds	Protect.	Privacy Film	Function	Card Reader	Mag Lock	Auto Opener	Hold Open	Hinges	Accessory 1	Accessory 2	Accessory 3	Closer
C	1	1220 x 2135	Solid Core	FRL	<input type="checkbox"/>	<input type="checkbox"/>	2 High	<input checked="" type="checkbox"/>	Storeroom	<input checked="" type="checkbox"/>	<input type="checkbox"/>	<input type="checkbox"/>	<input checked="" type="checkbox"/>	Butt Hinge				Surface

Door Remarks:  Security Grille  Anti-barricade strategy

**MILLWORK AND SPECIALTY CASEWORK**

**UPPER UNITS** (U1-U8) **LOWER UNITS** (L1-L9)

**RECEPTION/TRANSACTION COUNTER / CARE TEAM STATION DESK** (TC1, TC2)

**UTILITY SINK AND COUNTER UNIT** (UC1)

**Storage Requirements:**  SHELF (S1)

Category	Min. Length (mm)	Motorized Adjustable Height	Standing Height	Specialty Casework
3	1800	<input type="checkbox"/>	<input type="checkbox"/>	<input type="checkbox"/>

**FINISHES**

Full-height Cabinet:   
 Upper Millwork:   
 Countertop:   
 Lower Millwork:   
 Shelf:

Remarks:

**MECHANICAL REQUIREMENTS**

<b>PLUMBING</b> (Quantity) Hand Hygiene Sink: <input type="text" value="1"/> Lavatory: <input type="text"/> Kitchen Sink: <input type="text"/> Seamless Kitchen Sink: <input type="text"/> Utility / Process Sink: <input type="text" value="1"/> Scrub Sink: <input type="text"/> Floor Sink: <input type="text"/> Plumbing Remarks: <input type="text"/>	Other Fixtures: <input type="checkbox"/> Shower <input type="checkbox"/> Eyewash Station <input type="checkbox"/> Tub <input type="checkbox"/> Eyewash/Shower Station <input type="checkbox"/> Ice Maker <input type="checkbox"/> Emergency Shower <input type="checkbox"/> Water Closet <input checked="" type="checkbox"/> Floor Drain <input type="checkbox"/> Instantaneous Hot Water <input type="checkbox"/> Water Bottle Refill Station Other: <input type="text"/>	<b>MED / NON-MED GASES</b> (Quantity) Oxygen: <input type="text"/> Medical Air: <input type="text"/> Medical Vacuum: <input type="text"/> Nitrous Oxide: <input type="text"/> CO2: <input type="text"/> AGSS: <input type="text"/> Nitrogen: <input type="text"/> Laboratory Air: <input type="text"/> Laboratory Vacuum: <input type="text"/> Utility Compressed Air: <input type="text"/> Gas Remarks: <input type="text"/>
---	--	---



**Appendix 1B Minimum Room Requirements**

Room Name:

Program Number(s):	1. C7.09	7.	13.	19.	25.	31.	37.	43.
	2. F5.12	8.	14.	20.	26.	32.	38.	44.
	3.	9.	15.	21.	27.	33.	39.	45.
	4.	10.	16.	22.	28.	34.	40.	46.
	5.	11.	17.	23.	29.	35.	41.	47.
	6.	12.	18.	24.	30.	36.	42.	48.

**ARCHITECTURAL REQUIREMENTS**

<b>WALL AND CEILING</b> Wall Material: <input type="text" value="ARGB 1.2m AFF, GB above"/> Finish: <input type="text" value="PT"/> Ceiling Material: <input type="text" value="ACT"/> Finish: <input type="text" value="PF"/>	<b>WALL PROTECTION</b> Type: <input type="text" value="RHIS"/> <input checked="" type="checkbox"/> Corner Guards <input type="checkbox"/> Hand Rails <input type="checkbox"/> Bed Bumper / Locator Height: <input type="text" value="1350 mm"/> <input type="checkbox"/> Crash Rails <input type="checkbox"/> Chair Rail	<b>GLAZING</b> <input type="checkbox"/> Interior Glazing	<b>FLOORING TYPES</b> Material: <input type="text" value="SDVF"/> Base: <input type="text" value="FCB"/>	<b>ROOM ACCESSORIES</b> <input type="checkbox"/> Coat Hooks <input type="checkbox"/> Ceiling Lift <input type="checkbox"/> Magnetic Whiteboard <input type="checkbox"/> Mirror <input type="checkbox"/> Infant Change Table <input type="checkbox"/> Privacy Curtain
--	--	---	---	--

- LEGEND:**
- WALL AND CEILING LEGEND:**
- AC Architectural Ceiling
  - ACT Acoustic Ceiling Tile
  - ACT-C Cleanroom
  - ARGB Abuse-Resistant Gypsum Board
  - GB Gypsum Board
  - IRGB Impact-Resistant Gypsum Board
  - KLCT Kitchen Lay-in Ceiling Tile
  - MMRGB Moisture and Mould-Resistant Gypsum Board
  - SACT Security Acoustic Ceiling Tile
- WALL FINISHES LEGEND:**
- EWC Epoxy Wall Coating
  - HPC High Performance Coating
  - PT Paint
- CEILING FINISHES LEGEND:**
- ECC Epoxy Ceiling Coating
  - HPC High Performance Coating
  - PF Prefinished
  - PT Paint
- WALL PROTECTION LEGEND:**
- ESRP Extruded Semi-Rigid PVCu Panel
  - FRL Fibre Reinforced Laminate
  - FRP Fibreglass Reinforced Plastic
  - PVV Protective Vinyl Wallcovering
  - RHIS Rigid High Impact Sheet
  - WSSP Wetwall Solid Surface Panel
  - WVV Wetroom Vinyl Wallcovering
- FLOOR FINISHES LEGEND:**
- CFS Concrete Floor Sealer
  - EFC Epoxy Floor Coating
  - PFC Polyurethane Floor Coating
  - RAF Rubber Athletic Flooring
  - RSF Rubber Sheet Flooring
  - SCF Seamless Cushioned Flooring
  - SDRF Static-Dissipative Rubber Sheet Flooring
  - SDVF Static-Dissipative Vinyl Sheet Flooring
  - VSF Vinyl Sheet Flooring
  - WSVF Wetroom Safety Vinyl Sheet Flooring
- FLOOR BASE LEGEND:**
- FCB Flash Cove Base
  - RB Rubber Base
  - SCF Seamless Cushioned Flooring

**DOORS**

Types:

Type	Qty	Size (mm)	Material	Finish	Side Lt.	Blinds	Protect.	Privacy Film	Function	Card Reader	Mag Lock	Auto Opener	Hold Open	Hinges	Accessory 1	Accessory 2	Accessory 3	Closer
A	1	1220 x 2135	Solid Core	FRL	<input type="checkbox"/>	<input type="checkbox"/>	1 Low	<input type="checkbox"/>	Storeroom	<input checked="" type="checkbox"/>	<input type="checkbox"/>	<input type="checkbox"/>	<input type="checkbox"/>	Butt Hinge				Surface

Door Remarks:  Security Grille  Anti-barricade strategy

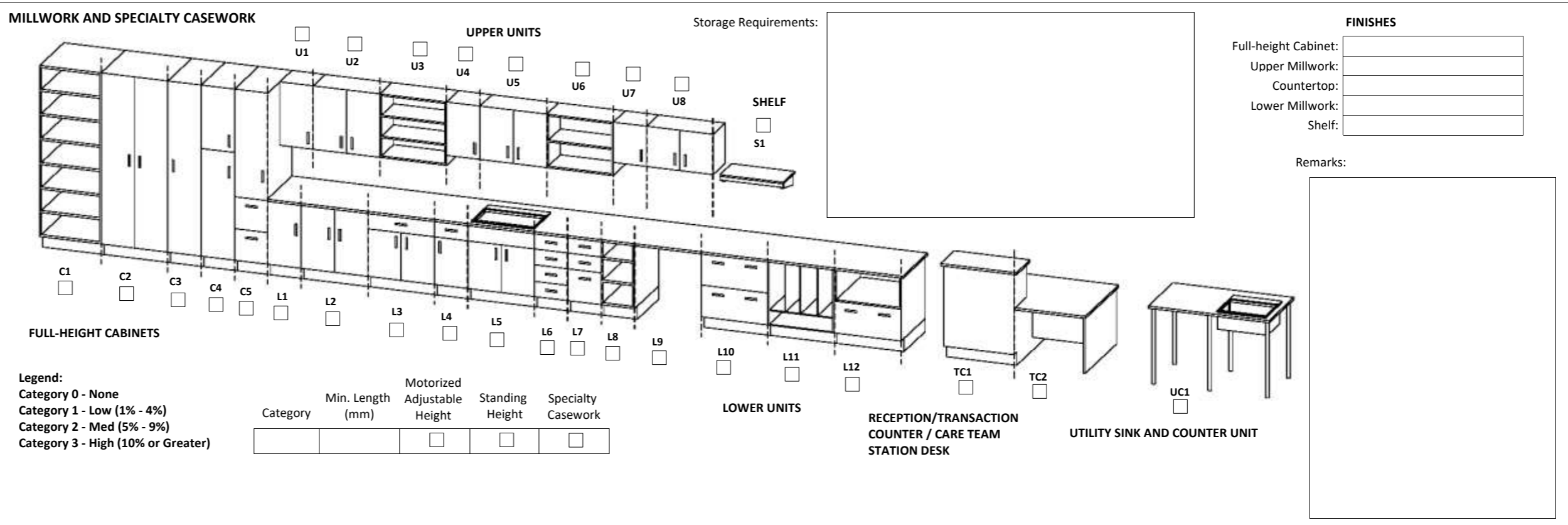

**MECHANICAL REQUIREMENTS**

<b>PLUMBING</b> (Quantity) Hand Hygiene Sink: <input type="text"/> Lavatory: <input type="text"/> Kitchen Sink: <input type="text"/> Seamless Kitchen Sink: <input type="text"/> Utility / Process Sink: <input type="text"/> Scrub Sink: <input type="text"/> Floor Sink: <input type="text"/> Plumbing Remarks: <input type="text"/>	Other Fixtures: <input type="checkbox"/> Shower <input type="checkbox"/> Eyewash Station <input type="checkbox"/> Tub <input type="checkbox"/> Eyewash/Shower Station <input type="checkbox"/> Ice Maker <input type="checkbox"/> Emergency Shower <input type="checkbox"/> Water Closet <input type="checkbox"/> Flush Rim Sink <input type="checkbox"/> Instantaneous Hot Water <input type="checkbox"/> Floor Drain <input type="checkbox"/> <input type="checkbox"/> Water Bottle Refill Station Other <input type="text"/>	<b>MED / NON-MED GASES</b> (Quantity) Oxygen: <input type="text"/> Medical Air: <input type="text"/> Medical Vacuum: <input type="text"/> Nitrous Oxide: <input type="text"/> CO2: <input type="text"/> AGSS: <input type="text"/> Nitrogen: <input type="text"/> Laboratory Air: <input type="text"/> Laboratory Vacuum: <input type="text"/> Utility Compressed Air: <input type="text"/> Gas Remarks: <input type="text"/>
---	--	---

**Appendix 1B Minimum Room Requirements**

Room Name:

Program Number(s):

1. B3.10	7. I2.10	13.	19.	25.	31.	37.	43.
2. D1.05	8. J3.03	14.	20.	26.	32.	38.	44.
3. F2.08	9. K3.06	15.	21.	27.	33.	39.	45.
4. F3.05	10. L1.10	16.	22.	28.	34.	40.	46.
5. G1.07	11. L2.07	17.	23.	29.	35.	41.	47.
6. I1.03	12. M2.05	18.	24.	30.	36.	42.	48.

**ARCHITECTURAL REQUIREMENTS**

<b>WALL AND CEILING</b> Wall Material: <input type="text" value="ARGB 1.2m AFF, GB above"/> Finish: <input type="text" value="EWC"/> Ceiling Material: <input type="text" value="ARGB"/> Finish: <input type="text" value="ECC"/>		<b>WALL PROTECTION</b> Type: <input type="text" value="PVW"/> <input checked="" type="checkbox"/> Corner Guards <input type="checkbox"/> Hand Rails <input type="checkbox"/> Bed Bumper / Locator Height: <input type="text" value="1350 mm"/> <input type="checkbox"/> Crash Rails <input checked="" type="checkbox"/> Chair Rail		<b>GLAZING</b> <input checked="" type="checkbox"/> Interior Glazing		<b>FLOORING TYPES</b> Material: <input type="text" value="RSF"/> Base: <input type="text" value="FCB"/>		<b>ROOM ACCESSORIES</b> <input checked="" type="checkbox"/> Coat Hooks <input type="checkbox"/> Ceiling Lift <input checked="" type="checkbox"/> Magnetic Whiteboard <input type="checkbox"/> Mirror <input type="checkbox"/> Infant Change Table <input type="checkbox"/> Privacy Curtain	
---	--	--	--	--	--	--	--	--	--

- LEGEND:**
- WALL AND CEILING LEGEND:**
- AC Architectural Ceiling
  - ACT Acoustic Ceiling Tile
  - ACT-C Cleanroom
  - ARGB Abuse-Resistant Gypsum Board
  - GB Gypsum Board
  - IRGB Impact-Resistant Gypsum Board
  - KLCT Kitchen Lay-in Ceiling Tile
  - MMRGB Moisture and Mould-Resistant Gypsum Board
  - SACT Security Acoustic Ceiling Tile
- WALL FINISHES LEGEND:**
- EWC Epoxy Wall Coating
  - HPC High Performance Coating
  - PT Paint
- CEILING FINISHES LEGEND:**
- ECC Epoxy Ceiling Coating
  - HPC High Performance Coating
  - PF Prefinished
  - PT Paint
- WALL PROTECTION LEGEND:**
- ESRP Extruded Semi-Rigid PVCu Panel
  - FRL Fibre Reinforced Laminate
  - FRP Fibreglass Reinforced Plastic
  - PVW Protective Vinyl Wallcovering
  - RHIS Rigid High Impact Sheet
  - WSSP Wetwall Solid Surface Panel
  - WVV Wetroom Vinyl Wallcovering
- FLOOR FINISHES LEGEND:**
- CFS Concrete Floor Sealer
  - EFC Epoxy Floor Coating
  - PFC Polyurethane Floor Coating
  - RAF Rubber Athletic Flooring
  - RSF Rubber Sheet Flooring
  - SCF Seamless Cushioned Flooring
  - SDRF Static-Dissipative Rubber Sheet Flooring
  - SDVF Static-Dissipative Vinyl Sheet Flooring
  - VSF Vinyl Sheet Flooring
  - WSVF Wetroom Safety Vinyl Sheet Flooring
- FLOOR BASE LEGEND:**
- FCB Flash Cove Base
  - RB Rubber Base
  - SCF Seamless Cushioned Flooring

**DOORS**

Types:

Type	Qty	Size (mm)	Material	Finish	Side Lt.	Blinds	Protect.	Film	Function	Card Reader	Mag Lock	Auto Opener	Hold Open	Hinges	Accessory 1	Accessory 2	Accessory 3	Closer
C	1	1220 x 2135	Solid Core	FRL	<input type="checkbox"/>	<input type="checkbox"/>	1 Low	<input type="checkbox"/>	Storeroom	<input checked="" type="checkbox"/>	<input type="checkbox"/>	<input type="checkbox"/>	<input type="checkbox"/>	Butt Hinge				Surface
C	1	915 x 2135	Solid Core	FRL	<input type="checkbox"/>	<input type="checkbox"/>	1 Low	<input type="checkbox"/>	Storeroom	<input checked="" type="checkbox"/>	<input type="checkbox"/>	<input type="checkbox"/>	<input type="checkbox"/>	Butt Hinge				Surface

Door Remarks:  Security Grille  Anti-barricade strategy

**MILLWORK AND SPECIALTY CASEWORK**

Storage Requirements:

**FINISHES**

Full-height Cabinet:

Upper Millwork:

Countertop:

Lower Millwork:

Shelf:

Remarks: Provide I1.03 with interior window with privacy film.

**MECHANICAL REQUIREMENTS**

<b>PLUMBING</b> (Quantity) Hygiene Sink: <input type="text"/> Lavatory: <input type="text"/> Kitchen Sink: <input type="text"/> Kitchen Sink: <input type="text"/> Utility / Process Sink: <input type="text"/> Scrub Sink: <input type="text"/> Floor Sink: <input type="text"/>		Other Fixtures: <input type="checkbox"/> Shower <input type="checkbox"/> Eyewash Station <input type="checkbox"/> Tub <input type="checkbox"/> Eyewash/Shower Station <input type="checkbox"/> Ice Maker <input type="checkbox"/> Emergency Shower <input type="checkbox"/> Water Closet <input type="checkbox"/> Flush Rim Sink <input type="checkbox"/> Instantaneous Hot Water <input type="checkbox"/> Floor Drain <input type="checkbox"/> <input type="checkbox"/> Water Bottle Refill Station Other <input type="text"/>		<b>MED / NON-MED GASES</b> (Quantity) Oxygen: <input type="text"/> Medical Air: <input type="text"/> Medical Vacuum: <input type="text"/> Nitrous Oxide: <input type="text"/> CO2: <input type="text"/> AGSS: <input type="text"/> Nitrogen: <input type="text"/> Laboratory Air: <input type="text"/> Laboratory Vacuum: <input type="text"/> Utility Compressed Air: <input type="text"/>	
Plumbing Remarks: <input type="text" value="Provide HHS for Consult rooms in oncology ambulatory care (G1.07)"/>				Gas Remarks: <input type="text"/>	

**Appendix 1B Minimum Room Requirements**

Room Name:

Program Number(s):

1. C7.06	7.	13.	19.	25.	31.	37.	43.
2. F4.08	8.	14.	20.	26.	32.	38.	44.
3.	9.	15.	21.	27.	33.	39.	45.
4.	10.	16.	22.	28.	34.	40.	46.
5.	11.	17.	23.	29.	35.	41.	47.
6.	12.	18.	24.	30.	36.	42.	48.

**ARCHITECTURAL REQUIREMENTS**

<b>WALL AND CEILING</b> Wall Material: <input type="text" value="ARGB 1.2m AFF, GB above"/> Finish: <input type="text" value="PT"/> Ceiling Material: <input type="text" value="ACT"/> Finish: <input type="text" value="PF"/>		<b>WALL PROTECTION</b> Type: <input type="text" value="FRP"/> <input checked="" type="checkbox"/> Corner Guards <input type="checkbox"/> Hand Rails <input type="checkbox"/> Bed Bumper / Locator Height: <input type="text" value="1600 mm"/> <input type="checkbox"/> Crash Rails <input checked="" type="checkbox"/> Chair Rail		<b>GLAZING</b> <input checked="" type="checkbox"/> Interior Glazing		<b>FLOORING TYPES</b> Material: <input type="text" value="SDVF"/> Base: <input type="text" value="FCB"/>		<b>ROOM ACCESSORIES</b> <input checked="" type="checkbox"/> Coat Hooks <input type="checkbox"/> Ceiling Lift <input checked="" type="checkbox"/> Magnetic Whiteboard <input type="checkbox"/> Mirror <input type="checkbox"/> Infant Change Table <input type="checkbox"/> Privacy Curtain	
--	--	--	--	--	--	---	--	--	--

- LEGEND:**
- WALL AND CEILING LEGEND:**
- AC Architectural Ceiling
  - ACT Acoustic Ceiling Tile
  - ACT-C Cleanroom
  - ARGB Abuse-Resistant Gypsum Board
  - GB Gypsum Board
  - IRGB Impact-Resistant Gypsum Board
  - KLCT Kitchen Lay-in Ceiling Tile
  - MMRGB Moisture and Mould-Resistant Gypsum Board
  - SACT Security Acoustic Ceiling Tile
- WALL FINISHES LEGEND:**
- EWC Epoxy Wall Coating
  - HPC High Performance Coating
  - PT Paint
- CEILING FINISHES LEGEND:**
- ECC Epoxy Ceiling Coating
  - HPC High Performance Coating
  - PF Prefinished
  - PT Paint
- WALL PROTECTION LEGEND:**
- ESRP Extruded Semi-Rigid PVCu Panel
  - FRL Fibre Reinforced Laminate
  - FRP Fibreglass Reinforced Plastic
  - PVV Protective Vinyl Wallcovering
  - RHIS Rigid High Impact Sheet
  - WSSP Wetwall Solid Surface Panel
  - WVV Wetroom Vinyl Wallcovering
- FLOOR FINISHES LEGEND:**
- CFS Concrete Floor Sealer
  - EFC Epoxy Floor Coating
  - PFC Polyurethane Floor Coating
  - RAF Rubber Athletic Flooring
  - RSF Rubber Sheet Flooring
  - SCF Seamless Cushioned Flooring
  - SDRF Static-Dissipative Rubber Sheet Flooring
  - SDVF Static-Dissipative Vinyl Sheet Flooring
  - VSF Vinyl Sheet Flooring
  - WSVF Wetroom Safety Vinyl Sheet Flooring
- FLOOR BASE LEGEND:**
- FCB Flash Cove Base
  - RB Rubber Base
  - SCF Seamless Cushioned Flooring

**DOORS**

Types:

Type	Qty	Size (mm)	Material	Finish	Side Lt.	Blinds	Protect.	Privacy Film	Function	Card Reader	Mag Lock	Auto Opener	Hold Open	Hinges	Accessory 1	Accessory 2	Accessory 3	Closer
C	1	1065 x 2135	Solid Core	FRL	<input type="checkbox"/>	<input checked="" type="checkbox"/>	1 Low	<input type="checkbox"/>	Passage	<input type="checkbox"/>	<input type="checkbox"/>	<input type="checkbox"/>	<input type="checkbox"/>	Butt Hinge				Surface

Door Remarks:  Security Grille  Anti-barricade strategy

**MILLWORK AND SPECIALTY CASEWORK**

**UPPER UNITS** (U1-U8) **LOWER UNITS** (L1-L9) **RECEPTION/TRANSACTION COUNTER / CARE TEAM STATION DESK** (TC1-TC2) **UTILITY SINK AND COUNTER UNIT** (UC1)

Storage Requirements:

**FINISHES**

Full-height Cabinet:

Upper Millwork:

Countertop:

Lower Millwork:

Shelf:

Remarks:

Category	Min. Length (mm)	Motorized Adjustable Height	Standing Height	Specialty Casework
3	900	<input type="checkbox"/>	<input type="checkbox"/>	<input type="checkbox"/>

**MECHANICAL REQUIREMENTS**

<b>PLUMBING</b> (Quantity) Hand Hygiene Sink: <input type="text"/> Lavatory: <input type="text"/> Kitchen Sink: <input type="text"/> Seamless Kitchen Sink: <input type="text"/> Utility / Process Sink: <input type="text"/> Scrub Sink: <input type="text"/> Floor Sink: <input type="text"/> Plumbing Remarks: <input type="text"/>		Other Fixtures: <input type="checkbox"/> Shower <input type="checkbox"/> Tub <input type="checkbox"/> Ice Maker <input type="checkbox"/> Water Closet <input type="checkbox"/> Instantaneous Hot Water <input type="checkbox"/> Eyewash Station <input type="checkbox"/> Eyewash/Shower Station <input type="checkbox"/> Emergency Shower <input type="checkbox"/> Flush Rim Sink <input type="checkbox"/> Floor Drain <input type="checkbox"/> Water Bottle Refill Station Other: <input type="text"/>		<b>MED / NON-MED GASES</b> (Quantity) Oxygen: <input type="text"/> Medical Air: <input type="text"/> Medical Vacuum: <input type="text"/> Nitrous Oxide: <input type="text"/> CO2: <input type="text"/> AGSS: <input type="text"/> Nitrogen: <input type="text"/> Laboratory Air: <input type="text"/> Laboratory Vacuum: <input type="text"/> Utility Compressed Air: <input type="text"/> Gas Remarks: <input type="text"/>	
--	--	--	--	---	--



**Appendix 1B Minimum Room Requirements**

Room Name:

Program Number(s):

1. C7.08	7.	13.	19.	25.	31.	37.	43.
2. F5.11	8.	14.	20.	26.	32.	38.	44.
3.	9.	15.	21.	27.	33.	39.	45.
4.	10.	16.	22.	28.	34.	40.	46.
5.	11.	17.	23.	29.	35.	41.	47.
6.	12.	18.	24.	30.	36.	42.	48.

**ARCHITECTURAL REQUIREMENTS**

<b>WALL AND CEILING</b> Wall Material: <input type="text" value="ARGB 1.2m AFF, GB above"/> Finish: <input type="text" value="PT"/> Ceiling Material: <input type="text" value="ACT"/> Finish: <input type="text" value="PF"/>		<b>WALL PROTECTION</b> Type: <input type="text" value="FRP"/> <input checked="" type="checkbox"/> Corner Guards <input type="checkbox"/> Hand Rails <input type="checkbox"/> Bed Bumper / Locator Height: <input type="text" value="1600 mm"/> <input type="checkbox"/> Crash Rails <input checked="" type="checkbox"/> Chair Rail		<b>GLAZING</b> <input checked="" type="checkbox"/> Interior Glazing		<b>FLOORING TYPES</b> Material: <input type="text" value="SDVF"/> Base: <input type="text" value="FCB"/>		<b>ROOM ACCESSORIES</b> <input type="checkbox"/> Coat Hooks <input type="checkbox"/> Ceiling Lift <input checked="" type="checkbox"/> Magnetic Whiteboard <input type="checkbox"/> Mirror <input type="checkbox"/> Infant Change Table <input type="checkbox"/> Privacy Curtain	
--	--	--	--	--	--	---	--	---	--

- LEGEND:**
- WALL AND CEILING LEGEND:**
- AC Architectural Ceiling
  - ACT Acoustic Ceiling Tile
  - ACT-C Cleanroom
  - ARGB Abuse-Resistant Gypsum Board
  - GB Gypsum Board
  - IRGB Impact-Resistant Gypsum Board
  - KLCT Kitchen Lay-in Ceiling Tile
  - MMRGB Moisture and Mould-Resistant Gypsum Board
  - SACT Security Acoustic Ceiling Tile
- WALL FINISHES LEGEND:**
- EWC Epoxy Wall Coating
  - HPC High Performance Coating
  - PT Paint
- CEILING FINISHES LEGEND:**
- ECC Epoxy Ceiling Coating
  - HPC High Performance Coating
  - PF Prefinished
  - PT Paint
- WALL PROTECTION LEGEND:**
- ESRP Extruded Semi-Rigid PVCu Panel
  - FRL Fibre Reinforced Laminate
  - FRP Fibreglass Reinforced Plastic
  - PVV Protective Vinyl Wallcovering
  - RHIS Rigid High Impact Sheet
  - WSSP Wetwall Solid Surface Panel
  - WVV Wetroom Vinyl Wallcovering
- FLOOR FINISHES LEGEND:**
- CFS Concrete Floor Sealer
  - EFC Epoxy Floor Coating
  - PFC Polyurethane Floor Coating
  - RAF Rubber Athletic Flooring
  - RSF Rubber Sheet Flooring
  - SCF Seamless Cushioned Flooring
  - SDRF Static-Dissipative Rubber Sheet Flooring
  - SDVF Static-Dissipative Vinyl Sheet Flooring
  - VSF Vinyl Sheet Flooring
  - WSVF Wetroom Safety Vinyl Sheet Flooring
- FLOOR BASE LEGEND:**
- FCB Flash Cove Base
  - RB Rubber Base
  - SCF Seamless Cushioned Flooring

**DOORS**

Types:

Type	Qty	Size (mm)	Material	Finish	Side Lt	Blinds	Protect	Privacy Film	Function	Card Reader	Mag Lock	Auto Opener	Hold Open	Hinges	Accessory 1	Accessory 2	Accessory 3	Closer
C	1	1065 x 2135	Solid Core	FRL	<input type="checkbox"/>	<input checked="" type="checkbox"/>	1 Low	<input type="checkbox"/>	Storeroom	<input checked="" type="checkbox"/>	<input type="checkbox"/>	<input type="checkbox"/>	<input type="checkbox"/>	Butt Hinge				Surface
B	2	1065 x 2135	Shielded	Prefinished	<input type="checkbox"/>	<input type="checkbox"/>	1 Low	<input type="checkbox"/>	Passage	<input type="checkbox"/>	<input type="checkbox"/>	<input type="checkbox"/>	<input type="checkbox"/>	Butt Hinge				Surface

Door Remarks: Preference is for design to not require doors from control room to imaging room. If internal doors are required, doors need to be shielded.

Security Grille  
 Anti-barricade strategy

**MILLWORK AND SPECIALTY CASEWORK**

Storage Requirements:

**UPPER UNITS** (U1-U8)

**LOWER UNITS** (L1-L12)

**RECEPTION/TRANSACTION COUNTER / CARE TEAM STATION DESK** (TC1, TC2)

**UTILITY SINK AND COUNTER UNIT** (UC1)

**SHELF** (S1)

**FULL-HEIGHT CABINETS** (C1-C5)

**Legend:**

Category	Min. Length (mm)	Motorized Adjustable Height	Standing Height	Specialty Casework
Category 0 - None				
Category 1 - Low (1% - 4%)				
Category 2 - Med (5% - 9%)				
Category 3 - High (10% or Greater)				

Remarks:

**MECHANICAL REQUIREMENTS**

<b>PLUMBING</b> (Quantity) Hand Hygiene Sink: <input type="text"/> Lavatory: <input type="text"/> Kitchen Sink: <input type="text"/> Seamless Kitchen Sink: <input type="text"/> Utility / Process Sink: <input type="text"/> Scrub Sink: <input type="text"/> Floor Sink: <input type="text"/>		Other Fixtures: <input type="checkbox"/> Shower <input type="checkbox"/> Eyewash Station <input type="checkbox"/> Tub <input type="checkbox"/> Eyewash/Shower Station <input type="checkbox"/> Ice Maker <input type="checkbox"/> Emergency Shower <input type="checkbox"/> Water Closet <input type="checkbox"/> Flush Rim Sink <input type="checkbox"/> Instantaneous Hot Water <input type="checkbox"/> Floor Drain <input type="checkbox"/> Water Bottle Refill Station Other: <input type="text"/>		<b>MED / NON-MED GASES</b> (Quantity) Oxygen: <input type="text"/> Medical Air: <input type="text"/> Medical Vacuum: <input type="text"/> Nitrous Oxide: <input type="text"/> CO2: <input type="text"/> AGSS: <input type="text"/> Nitrogen: <input type="text"/> Laboratory Air: <input type="text"/> Laboratory Vacuum: <input type="text"/> Utility Compressed Air: <input type="text"/>	
Plumbing Remarks: <input type="text"/>		Gas Remarks: <input type="text"/>			

**Appendix 1B Minimum Room Requirements**

Room Name:

Program Number(s):

1. A3.05	7.	13.	19.	25.	31.	37.	43.
2. C4.09	8.	14.	20.	26.	32.	38.	44.
3. G2.06	9.	15.	21.	27.	33.	39.	45.
4. I2.08	10.	16.	22.	28.	34.	40.	46.
5. L2.05	11.	17.	23.	29.	35.	41.	47.
6.	12.	18.	24.	30.	36.	42.	48.

**ARCHITECTURAL REQUIREMENTS**

<b>WALL AND CEILING</b> Wall Material: <input type="text" value="MMRGB"/> Finish: <input type="text" value="HPC"/> Ceiling Material: <input type="text" value="MMRGB"/> Finish: <input type="text" value="HPC"/>	<b>WALL PROTECTION</b> Type: <input type="text" value="WSSP"/> <input checked="" type="checkbox"/> Corner Guards <input type="checkbox"/> Hand Rails <input type="checkbox"/> Bed Bumper / Locator Height: <input type="text" value="2185 mm"/> <input type="checkbox"/> Crash Rails <input type="checkbox"/> Chair Rail	<b>GLAZING</b> <input type="checkbox"/> Interior Glazing	<b>FLOORING TYPES</b> Material: <input type="text" value="WSVF"/> Base: <input type="text" value="FCB"/>	<b>ROOM ACCESSORIES</b> <input checked="" type="checkbox"/> Coat Hooks <input checked="" type="checkbox"/> Ceiling Lift <input type="checkbox"/> Magnetic Whiteboard <input checked="" type="checkbox"/> Mirror <input type="checkbox"/> Infant Change Table <input type="checkbox"/> Privacy Curtain
--	--	---	---	---

- LEGEND:**
- WALL AND CEILING LEGEND:**
- AC Architectural Ceiling
  - ACT Acoustic Ceiling Tile
  - ACT-C Cleanroom
  - ARGB Abuse-Resistant Gypsum Board
  - GB Gypsum Board
  - IRGB Impact-Resistant Gypsum Board
  - KLCT Kitchen Lay-in Ceiling Tile
  - MMRGB Moisture and Mould-Resistant Gypsum Board
  - SACT Security Acoustic Ceiling Tile
- WALL FINISHES LEGEND:**
- EWC Epoxy Wall Coating
  - HPC High Performance Coating
  - PT Paint
- CEILING FINISHES LEGEND:**
- ECC Epoxy Ceiling Coating
  - HPC High Performance Coating
  - PF Prefinished
  - PT Paint
- WALL PROTECTION LEGEND:**
- ESRP Extruded Semi-Rigid PVCu Panel
  - FRL Fibre Reinforced Laminate
  - FRP Fibreglass Reinforced Plastic
  - PVV Protective Vinyl Wallcovering
  - RHIS Rigid High Impact Sheet
  - WSSP Wetwall Solid Surface Panel
  - WVV Wetroom Vinyl Wallcovering
- FLOOR FINISHES LEGEND:**
- CFS Concrete Floor Sealer
  - EFC Epoxy Floor Coating
  - PFC Polyurethane Floor Coating
  - RAF Rubber Athletic Flooring
  - RSF Rubber Sheet Flooring
  - SCF Seamless Cushioned Flooring
  - SDRF Static-Dissipative Rubber Sheet Flooring
  - SDVF Static-Dissipative Vinyl Sheet Flooring
  - VSF Vinyl Sheet Flooring
  - WSVF Wetroom Safety Vinyl Sheet Flooring
- FLOOR BASE LEGEND:**
- FCB Flash Cove Base
  - RB Rubber Base
  - SCF Seamless Cushioned Flooring

**DOORS**

Types:

Type	Qty	Size (mm)	Material	Finish	Side Lt.	Blinds	Protect.	Privacy Film	Function	Card Reader	Mag Lock	Auto Opener	Hold Open	Hinges	Accessory 1	Accessory 2	Accessory 3	Closer
A	1	1065 x 2135	Solid Core	FRL	<input type="checkbox"/>	<input type="checkbox"/>	1 Low	<input type="checkbox"/>	Privacy	<input type="checkbox"/>	<input type="checkbox"/>	<input type="checkbox"/>	<input type="checkbox"/>	Butt Hinge				Surface

Door Remarks: Staff will be able to unlock from the outside. Door to swing out

Security Grille  
 Anti-barricade strategy

**MILLWORK AND SPECIALTY CASEWORK**

Storage Requirements:

**UPPER UNITS** (U1-U8) **LOWER UNITS** (L1-L12) **SHELF** (S1) **RECEPTION/TRANSACTION COUNTER / CARE TEAM STATION DESK** (TC1, TC2) **UTILITY SINK AND COUNTER UNIT** (UC1)

**FULL-HEIGHT CABINETS** (C1-C5)

**Legend:**  
 Category 0 - None  
 Category 1 - Low (1% - 4%)  
 Category 2 - Med (5% - 9%)  
 Category 3 - High (10% or Greater)

Category	Min. Length (mm)	Motorized Adjustable Height	Standing Height	Specialty Casework
2	600	<input type="checkbox"/>	<input type="checkbox"/>	<input type="checkbox"/>

**FINISHES**

Full-height Cabinet:   
 Upper Millwork:   
 Countertop:   
 Lower Millwork:   
 Shelf:

Remarks: Refer to Schedule 1, Section 11 73 00 – X-Y Gantry Ceiling Lift System

**MECHANICAL REQUIREMENTS**

<b>PLUMBING</b> (Quantity) Hygiene Sink: <input type="text"/> Lavatory: <input type="text" value="1"/> Kitchen Sink: <input type="text"/> Seamless Kitchen Sink: <input type="text"/> Utility / Process Sink: <input type="text"/> Scrub Sink: <input type="text"/> Floor Sink: <input type="text"/> Plumbing Remarks: Provide bedpan disinfecter for C4.09	<b>Other Fixtures:</b> <input type="checkbox"/> Shower <input type="checkbox"/> Tub <input type="checkbox"/> Ice Maker <input checked="" type="checkbox"/> Water Closet <input type="checkbox"/> Instantaneous Hot Water <input type="checkbox"/> Eyewash Station <input type="checkbox"/> Eyewash/Shower Station <input type="checkbox"/> Emergency Shower <input type="checkbox"/> Flush Rim Sink <input type="checkbox"/> Floor Drain <input type="checkbox"/> Water Bottle Refill Station Other: <input type="text"/>	<b>MED / NON-MED GASES</b> (Quantity) Oxygen: <input type="text"/> Medical Air: <input type="text"/> Medical Vacuum: <input type="text"/> Nitrous Oxide: <input type="text"/> CO2: <input type="text"/> AGSS: <input type="text"/> Nitrogen: <input type="text"/> Laboratory Air: <input type="text"/> Laboratory Vacuum: <input type="text"/> Utility Compressed Air: <input type="text"/> Gas Remarks: <input type="text"/>
---	--	---

**Appendix 1B Minimum Room Requirements**

Room Name:

Program Number(s):

1. C3.14	7.	13.	19.	25.	31.	37.	43.
2. D6.07	8.	14.	20.	26.	32.	38.	44.
3. G2.09	9.	15.	21.	27.	33.	39.	45.
4.	10.	16.	22.	28.	34.	40.	46.
5.	11.	17.	23.	29.	35.	41.	47.
6.	12.	18.	24.	30.	36.	42.	48.

**ARCHITECTURAL REQUIREMENTS**

<b>WALL AND CEILING</b> Wall Material: <input type="text" value="MMRGB"/> Finish: <input type="text" value="HPC"/> Ceiling Material: <input type="text" value="MMRGB"/> Finish: <input type="text" value="HPC"/>	<b>WALL PROTECTION</b> Type: <input type="text" value="WSSP"/> <input checked="" type="checkbox"/> Corner Guards <input type="checkbox"/> Hand Rails <input type="checkbox"/> Bed Bumper / Locator Height: <input type="text" value="2185 mm"/> <input type="checkbox"/> Crash Rails <input type="checkbox"/> Chair Rail	<b>GLAZING</b> <input type="checkbox"/> Interior Glazing	<b>FLOORING TYPES</b> Material: <input type="text" value="WSVF"/> Base: <input type="text" value="FCB"/>	<b>ROOM ACCESSORIES</b> <input checked="" type="checkbox"/> Coat Hooks <input checked="" type="checkbox"/> Ceiling Lift <input type="checkbox"/> Magnetic Whiteboard <input checked="" type="checkbox"/> Mirror <input type="checkbox"/> Infant Change Table <input type="checkbox"/> Privacy Curtain
--	--	---	---	---

- LEGEND:**
- WALL AND CEILING LEGEND:**
- AC Architectural Ceiling
  - ACT Acoustic Ceiling Tile
  - ACT-C Cleanroom
  - ARGB Abuse-Resistant Gypsum Board
  - GB Gypsum Board
  - IRGB Impact-Resistant Gypsum Board
  - KLCT Kitchen Lay-in Ceiling Tile
  - MMRGB Moisture and Mould-Resistant Gypsum Board
  - SACT Security Acoustic Ceiling Tile
- WALL FINISHES LEGEND:**
- EWC Epoxy Wall Coating
  - HPC High Performance Coating
  - PT Paint
- CEILING FINISHES LEGEND:**
- ECC Epoxy Ceiling Coating
  - HPC High Performance Coating
  - PF Prefinished
  - PT Paint
- WALL PROTECTION LEGEND:**
- ESRP Extruded Semi-Rigid PVCu Panel
  - FRL Fibre Reinforced Laminate
  - FRP Fibreglass Reinforced Plastic
  - PVV Protective Vinyl Wallcovering
  - RHIS Rigid High Impact Sheet
  - WSSP Wetwall Solid Surface Panel
  - WVV Wetroom Vinyl Wallcovering
- FLOOR FINISHES LEGEND:**
- CFS Concrete Floor Sealer
  - EFC Epoxy Floor Coating
  - PFC Polyurethane Floor Coating
  - RAF Rubber Athletic Flooring
  - RSF Rubber Sheet Flooring
  - SCF Seamless Cushioned Flooring
  - SDRF Static-Dissipative Rubber Sheet Flooring
  - SDVF Static-Dissipative Vinyl Sheet Flooring
  - VSF Vinyl Sheet Flooring
  - WSVF Wetroom Safety Vinyl Sheet Flooring
- FLOOR BASE LEGEND:**
- FCB Flash Cove Base
  - RB Rubber Base
  - SCF Seamless Cushioned Flooring

**DOORS**

Types:

Note: for Type F doors, the door panels will be approximately 465/1065 unless otherwise required by the Authority

Door Remarks:  Staff will be able to unlock from the outside. Door to swing out  Security Grille  Anti-barricade strategy

Type	Qty	Size (mm)	Material	Finish	Side Lt.	Blinds	Protect.	Privacy Film	Function	Card Reader	Mag Lock	Auto Opener	Hold Open	Hinges	Accessory 1	Accessory 2	Accessory 3	Closer
F	1	1530 x 2135	Solid Core	FRL	<input type="checkbox"/>	<input type="checkbox"/>	1 Low	<input type="checkbox"/>	Privacy	<input type="checkbox"/>	<input type="checkbox"/>	<input type="checkbox"/>	<input type="checkbox"/>	Butt Hinge				Surface

**MILLWORK AND SPECIALTY CASEWORK**

Storage Requirements:

**UPPER UNITS** (U1-U8) **SHELF** (S1)

**FULL-HEIGHT CABINETS** (C1-C5) **LOWER UNITS** (L1-L12) **RECEPTION/TRANSACTION COUNTER / CARE TEAM STATION DESK** (TC1-TC2) **UTILITY SINK AND COUNTER UNIT** (UC1)

**Legend:**

Category	Min. Length (mm)	Motorized Adjustable Height	Standing Height	Specialty Casework
Category 0 - None				
Category 1 - Low (1% - 4%)				
Category 2 - Med (5% - 9%)				
Category 3 - High (10% or Greater)				

**FINISHES**

Full-height Cabinet:   
 Upper Millwork:   
 Countertop:   
 Lower Millwork:   
 Shelf:

Remarks: Refer to Schedule 1, Section 11 73 00 - X-Y Gantry Ceiling Lift System

**MECHANICAL REQUIREMENTS**

<b>PLUMBING</b> (Quantity) Hand Hygiene Sink: <input type="text"/> Lavatory: <input type="text" value="1"/> Kitchen Sink: <input type="text"/> Seamless Kitchen Sink: <input type="text"/> Utility / Process Sink: <input type="text"/> Scrub Sink: <input type="text"/> Floor Sink: <input type="text"/> Plumbing Remarks: Provide bedpan disinfectant for C3.14 and D6.07	<b>Other Fixtures:</b> <input type="checkbox"/> Shower <input type="checkbox"/> Tub <input type="checkbox"/> Ice Maker <input checked="" type="checkbox"/> Water Closet <input type="checkbox"/> Instantaneous Hot Water <input type="checkbox"/> Eyewash Station <input type="checkbox"/> Eyewash/Shower Station <input type="checkbox"/> Emergency Shower <input type="checkbox"/> Flush Rim Sink <input type="checkbox"/> Floor Drain <input type="checkbox"/> Water Bottle Refill Station Other: <input type="text"/>	<b>MED / NON-MED GASES</b> (Quantity) Oxygen: <input type="text"/> Medical Air: <input type="text"/> Medical Vacuum: <input type="text"/> Nitrous Oxide: <input type="text"/> CO2: <input type="text"/> AGSS: <input type="text"/> Nitrogen: <input type="text"/> Laboratory Air: <input type="text"/> Laboratory Vacuum: <input type="text"/> Utility Compressed Air: <input type="text"/> Gas Remarks: <input type="text"/>
---	--	---



**Appendix 1B Minimum Room Requirements**

Room Name:

Program Number(s):

1. B1.03	7.	13.	19.	25.	31.	37.	43.
2. B2.02	8.	14.	20.	26.	32.	38.	44.
3.	9.	15.	21.	27.	33.	39.	45.
4.	10.	16.	22.	28.	34.	40.	46.
5.	11.	17.	23.	29.	35.	41.	47.
6.	12.	18.	24.	30.	36.	42.	48.

**ARCHITECTURAL REQUIREMENTS**

<b>WALL AND CEILING</b> Wall Material: <input type="text" value="MMRGB"/> Finish: <input type="text" value="HPC"/> Ceiling Material: <input type="text" value="MMRGB"/> Finish: <input type="text" value="HPC"/>	<b>WALL PROTECTION</b> Type: <input type="text" value="WSSP"/> <input checked="" type="checkbox"/> Corner Guards <input type="checkbox"/> Hand Rails <input type="checkbox"/> Bed Bumper / Locator Height: <input type="text" value="2185 mm"/> <input type="checkbox"/> Crash Rails <input type="checkbox"/> Chair Rail	<b>GLAZING</b> <input type="checkbox"/> Interior Glazing	<b>FLOORING TYPES</b> Material: <input type="text" value="WSVF"/> Base: <input type="text" value="FCB"/>	<b>ROOM ACCESSORIES</b> <input checked="" type="checkbox"/> Coat Hooks <input checked="" type="checkbox"/> Ceiling Lift <input type="checkbox"/> Magnetic Whiteboard <input checked="" type="checkbox"/> Mirror <input type="checkbox"/> Infant Change Table <input type="checkbox"/> Privacy Curtain
--	--	---	---	---

- LEGEND:**
- WALL AND CEILING LEGEND:**
- AC Architectural Ceiling
  - ACT Acoustic Ceiling Tile
  - ACT-C Cleanroom
  - ARGB Abuse-Resistant Gypsum Board
  - GB Gypsum Board
  - IRGB Impact-Resistant Gypsum Board
  - KLCT Kitchen Lay-in Ceiling Tile
  - MMRGB Moisture and Mould-Resistant Gypsum Board
  - SACT Security Acoustic Ceiling Tile
- WALL FINISHES LEGEND:**
- EWC Epoxy Wall Coating
  - HPC High Performance Coating
  - PT Paint
- CEILING FINISHES LEGEND:**
- ECC Epoxy Ceiling Coating
  - HPC High Performance Coating
  - PF Prefinished
  - PT Paint
- WALL PROTECTION LEGEND:**
- ESRP Extruded Semi-Rigid PVCu Panel
  - FRL Fibre Reinforced Laminate
  - FRP Fibreglass Reinforced Plastic
  - PVV Protective Vinyl Wallcovering
  - RHIS Rigid High Impact Sheet
  - WSSP Wetwall Solid Surface Panel
  - WVV Wetroom Vinyl Wallcovering
- FLOOR FINISHES LEGEND:**
- CFS Concrete Floor Sealer
  - EFC Epoxy Floor Coating
  - PFC Polyurethane Floor Coating
  - RAF Rubber Athletic Flooring
  - RSF Rubber Sheet Flooring
  - SCF Seamless Cushioned Flooring
  - SDRF Static-Dissipative Rubber Sheet Flooring
  - SDVF Static-Dissipative Vinyl Sheet Flooring
  - VSF Vinyl Sheet Flooring
  - WSVF Wetroom Safety Vinyl Sheet Flooring
- FLOOR BASE LEGEND:**
- FCB Flash Cove Base
  - RB Rubber Base
  - SCF Seamless Cushioned Flooring

**DOORS**

Types:

Type	Qty	Size (mm)	Material	Finish	Side Lt.	Blinds	Protect.	Film	Function	Card Reader	Mag Lock	Auto Opener	Hold Open	Hinges	Accessory 1	Accessory 2	Accessory 3	Closer
A	1	1065 x 2135	Solid Core	FRL	<input type="checkbox"/>	<input type="checkbox"/>	1 Low	<input type="checkbox"/>	Privacy	<input type="checkbox"/>	<input type="checkbox"/>	<input type="checkbox"/>	<input type="checkbox"/>	Butt Hinge				Surface

**Door Remarks:**  
 Staff will be able to unlock from the outside.  
 Door to swing out

Security Grille  
 Anti-barricade strategy

**MILLWORK AND SPECIALTY CASEWORK**

Storage Requirements:

**UPPER UNITS** (U1-U8) **SHELF** (S1)

**FULL-HEIGHT CABINETS** (C1-C5) **LOWER UNITS** (L1-L12) **RECEPTION/TRANSACTION COUNTER / CARE TEAM STATION DESK** (TC1-TC2) **UTILITY SINK AND COUNTER UNIT** (UC1)

Category	Min. Length (mm)	Motorized Adjustable Height	Standing Height	Specialty Casework
2	600	<input type="checkbox"/>	<input type="checkbox"/>	<input type="checkbox"/>

**FINISHES**

Full-height Cabinet:   
 Upper Millwork:   
 Countertop:   
 Lower Millwork:   
 Shelf:

**Remarks:**  
 Refer to Schedule 1, Section 11 73 00 – X-Y Gantry Ceiling Lift System

**MECHANICAL REQUIREMENTS**

<b>PLUMBING</b> (Quantity) Hand Hygiene Sink: <input type="text"/> Lavatory: <input type="text" value="1"/> Kitchen Sink: <input type="text"/> Seamless Kitchen Sink: <input type="text"/> Utility / Process Sink: <input type="text"/> Scrub Sink: <input type="text"/> Floor Sink: <input type="text"/> Plumbing Remarks: <input type="text"/>	Other Fixtures: <input checked="" type="checkbox"/> Shower <input type="checkbox"/> Tub <input type="checkbox"/> Ice Maker <input checked="" type="checkbox"/> Water Closet <input type="checkbox"/> Instantaneous Hot Water <input type="checkbox"/> Eyewash Station <input type="checkbox"/> Eyewash/Shower Station <input type="checkbox"/> Emergency Shower <input type="checkbox"/> Flush Rim Sink <input checked="" type="checkbox"/> Floor Drain <input type="checkbox"/> Water Bottle Refill Station Other: <input type="text"/>	<b>MED / NON-MED GASES</b> (Quantity) Oxygen: <input type="text"/> Medical Air: <input type="text"/> Medical Vacuum: <input type="text"/> Nitrous Oxide: <input type="text"/> CO2: <input type="text"/> AGSS: <input type="text"/> Nitrogen: <input type="text"/> Laboratory Air: <input type="text"/> Laboratory Vacuum: <input type="text"/> Utility Compressed Air: <input type="text"/> Gas Remarks: <input type="text"/>
---	---	---

**Appendix 1B Minimum Room Requirements**

Room Name:

Program Number(s):

1. B1.05	7.	13.	19.	25.	31.	37.	43.
2. B2.06	8.	14.	20.	26.	32.	38.	44.
3. B3.04	9.	15.	21.	27.	33.	39.	45.
4.	10.	16.	22.	28.	34.	40.	46.
5.	11.	17.	23.	29.	35.	41.	47.
6.	12.	18.	24.	30.	36.	42.	48.

**ARCHITECTURAL REQUIREMENTS**

<b>WALL AND CEILING</b> Wall Material: <input type="text" value="MMRGB"/> Finish: <input type="text" value="HPC"/> Ceiling Material: <input type="text" value="MMRGB"/> Finish: <input type="text" value="HPC"/>	<b>WALL PROTECTION</b> Type: <input type="text" value="WSSP"/> <input checked="" type="checkbox"/> Corner Guards <input type="checkbox"/> Hand Rails <input type="checkbox"/> Bed Bumper / Locator Height: <input type="text" value="2185 mm"/> <input type="checkbox"/> Crash Rails <input type="checkbox"/> Chair Rail	<b>GLAZING</b> <input type="checkbox"/> Interior Glazing	<b>FLOORING TYPES</b> Material: <input type="text" value="WSVF"/> Base: <input type="text" value="FCB"/>	<b>ROOM ACCESSORIES</b> <input checked="" type="checkbox"/> Coat Hooks <input checked="" type="checkbox"/> Ceiling Lift <input type="checkbox"/> Magnetic Whiteboard <input checked="" type="checkbox"/> Mirror <input type="checkbox"/> Infant Change Table <input type="checkbox"/> Privacy Curtain
--	--	---	---	---

- LEGEND:**
- WALL AND CEILING LEGEND:**
- AC Architectural Ceiling
  - ACT Acoustic Ceiling Tile
  - ACT-C Cleanroom
  - ARGB Abuse-Resistant Gypsum Board
  - GB Gypsum Board
  - IRGB Impact-Resistant Gypsum Board
  - KLCT Kitchen Lay-in Ceiling Tile
  - MMRGB Moisture and Mould-Resistant Gypsum Board
  - SACT Security Acoustic Ceiling Tile
- WALL FINISHES LEGEND:**
- EWC Epoxy Wall Coating
  - HPC High Performance Coating
  - PT Paint
- CEILING FINISHES LEGEND:**
- ECC Epoxy Ceiling Coating
  - HPC High Performance Coating
  - PF Prefinished
  - PT Paint
- WALL PROTECTION LEGEND:**
- ESRP Extruded Semi-Rigid PVCu Panel
  - FRL Fibre Reinforced Laminate
  - FRP Fibreglass Reinforced Plastic
  - PVVW Protective Vinyl Wallcovering
  - RHIS Rigid High Impact Sheet
  - WSSP Wetwall Solid Surface Panel
  - WVVW Wetroom Vinyl Wallcovering
- FLOOR FINISHES LEGEND:**
- CFS Concrete Floor Sealer
  - EFC Epoxy Floor Coating
  - PFC Polyurethane Floor Coating
  - RAF Rubber Athletic Flooring
  - RSF Rubber Sheet Flooring
  - SCF Seamless Cushioned Flooring
  - SDRF Static-Dissipative Rubber Sheet Flooring
  - SDVF Static-Dissipative Vinyl Sheet Flooring
  - VSF Vinyl Sheet Flooring
  - WSVF Wetroom Safety Vinyl Sheet Flooring
- FLOOR BASE LEGEND:**
- FCB Flash Cove Base
  - RB Rubber Base
  - SCF Seamless Cushioned Flooring

**DOORS**

Types:

Note: for Type F doors, the door panels will be approximately 465/1065 unless otherwise required by the Authority

Door Remarks:  Staff will be able to unlock from the outside. Door to swing out  Security Grille  Anti-barricade strategy

Type	Qty	Size (mm)	Material	Finish	Side Lt.	Blinds	Protect.	Privacy Film	Function	Card Reader	Mag Lock	Auto Opener	Hold Open	Hinges	Accessory 1	Accessory 2	Accessory 3	Closer
F	1	1530 x 2135	Solid Core	FRL	<input type="checkbox"/>	<input type="checkbox"/>	1 Low	<input type="checkbox"/>	Privacy	<input type="checkbox"/>	<input type="checkbox"/>	<input type="checkbox"/>	<input type="checkbox"/>	Butt Hinge	Astragal	Flush Bolt		

**MILLWORK AND SPECIALTY CASEWORK**

Storage Requirements:

**UPPER UNITS** (U1-U8) **SHELF** (S1) **LOWER UNITS** (L1-L12) **RECEPTION/TRANSACTION COUNTER / CARE TEAM STATION DESK** (TC1, TC2) **UTILITY SINK AND COUNTER UNIT** (UC1)

**FULL-HEIGHT CABINETS** (C1-C5)

**Legend:**

Category	Min. Length (mm)	Motorized Adjustable Height	Standing Height	Specialty Casework
Category 0 - None				
Category 1 - Low (1% - 4%)				
Category 2 - Med (5% - 9%)				
Category 3 - High (10% or Greater)				

**FINISHES**

Full-height Cabinet:   
 Upper Millwork:   
 Countertop:   
 Lower Millwork:   
 Shelf:

Remarks: Refer to Schedule 1, Section 11 73 00 – X-Y Gantry Ceiling Lift System

**MECHANICAL REQUIREMENTS**

<b>PLUMBING</b> (Quantity) Hand Hygiene Sink: <input type="text"/> Lavatory: <input type="text" value="1"/> Kitchen Sink: <input type="text"/> Kitchen Sink: <input type="text"/> Utility / Process Sink: <input type="text"/> Scrub Sink: <input type="text"/> Floor Sink: <input type="text"/> Plumbing Remarks: Provide floor mounted water closet and bedpan disinfector	Other Fixtures: <input checked="" type="checkbox"/> Shower <input type="checkbox"/> Tub <input type="checkbox"/> Ice Maker <input checked="" type="checkbox"/> Water Closet <input type="checkbox"/> Instantaneous Hot Water <input type="checkbox"/> Eyewash Station <input type="checkbox"/> Eyewash/Shower Station <input type="checkbox"/> Emergency Shower <input type="checkbox"/> Flush Rim Sink <input checked="" type="checkbox"/> Floor Drain <input type="checkbox"/> Water Bottle Refill Station Other: <input type="text"/>	<b>MED / NON-MED GASES</b> (Quantity) Oxygen: <input type="text"/> Medical Air: <input type="text"/> Medical Vacuum: <input type="text"/> Nitrous Oxide: <input type="text"/> CO2: <input type="text"/> AGSS: <input type="text"/> Nitrogen: <input type="text"/> Laboratory Air: <input type="text"/> Laboratory Vacuum: <input type="text"/> Utility Compressed Air: <input type="text"/> Gas Remarks: <input type="text"/>
---	---	---

**Appendix 1B Minimum Room Requirements**

Room Name:

Program Number(s):

1. B3.02	7.	13.	19.	25.	31.	37.	43.
2.	8.	14.	20.	26.	32.	38.	44.
3.	9.	15.	21.	27.	33.	39.	45.
4.	10.	16.	22.	28.	34.	40.	46.
5.	11.	17.	23.	29.	35.	41.	47.
6.	12.	18.	24.	30.	36.	42.	48.

**ARCHITECTURAL REQUIREMENTS**

<b>WALL AND CEILING</b> Wall Material: <input type="text" value="MMRGB"/> Finish: <input type="text" value="HPC"/> Ceiling Material: <input type="text" value="MMRGB"/> Finish: <input type="text" value="HPC"/>	<b>WALL PROTECTION</b> Type: <input type="text" value="WSSP"/> <input checked="" type="checkbox"/> Corner Guards <input type="checkbox"/> Hand Rails <input type="checkbox"/> Bed Bumper / Locator Height: <input type="text" value="2185 mm"/> <input type="checkbox"/> Crash Rails <input type="checkbox"/> Chair Rail	<b>GLAZING</b> <input type="checkbox"/> Interior Glazing	<b>FLOORING TYPES</b> Material: <input type="text" value="WSVF"/> Base: <input type="text" value="FCB"/>	<b>ROOM ACCESSORIES</b> <input checked="" type="checkbox"/> Coat Hooks <input checked="" type="checkbox"/> Ceiling Lift <input checked="" type="checkbox"/> Magnetic Whiteboard <input checked="" type="checkbox"/> Mirror <input type="checkbox"/> Infant Change Table <input checked="" type="checkbox"/> Privacy Curtain
--	--	---	---	---

- LEGEND:**
- WALL AND CEILING LEGEND:**
- AC Architectural Ceiling
  - ACT Acoustic Ceiling Tile
  - ACT-C Cleanroom
  - ARGB Abuse-Resistant Gypsum Board
  - GB Gypsum Board
  - IRGB Impact-Resistant Gypsum Board
  - KLCT Kitchen Lay-in Ceiling Tile
  - MMRGB Moisture and Mould-Resistant Gypsum Board
  - SACT Security Acoustic Ceiling Tile
- WALL FINISHES LEGEND:**
- EWC Epoxy Wall Coating
  - HPC High Performance Coating
  - PT Paint
- CEILING FINISHES LEGEND:**
- ECC Epoxy Ceiling Coating
  - HPC High Performance Coating
  - PF Prefinished
  - PT Paint
- WALL PROTECTION LEGEND:**
- ESRP Extruded Semi-Rigid PVCu Panel
  - FRL Fibre Reinforced Laminate
  - FRP Fibreglass Reinforced Plastic
  - PVV Protective Vinyl Wallcovering
  - RHIS Rigid High Impact Sheet
  - WSSP Wetwall Solid Surface Panel
  - WVV Wetroom Vinyl Wallcovering
- FLOOR FINISHES LEGEND:**
- CFS Concrete Floor Sealer
  - EFC Epoxy Floor Coating
  - PFC Polyurethane Floor Coating
  - RAF Rubber Athletic Flooring
  - RSF Rubber Sheet Flooring
  - SCF Seamless Cushioned Flooring
  - SDRF Static-Dissipative Rubber Sheet Flooring
  - SDVF Static-Dissipative Vinyl Sheet Flooring
  - VSF Vinyl Sheet Flooring
  - WSVF Wetroom Safety Vinyl Sheet Flooring
- FLOOR BASE LEGEND:**
- FCB Flash Cove Base
  - RB Rubber Base
  - SCF Seamless Cushioned Flooring

**DOORS**

Types:

Type	Qty	Size (mm)	Material	Finish	Side Lt.	Blinds	Protect.	Privacy Film	Function	Card Reader	Mag Lock	Auto Opener	Hold Open	Hinges	Accessory 1	Accessory 2	Accessory 3	Closer
A	1	1065 x 2135	Solid Core	FRL	<input type="checkbox"/>	<input type="checkbox"/>	1 Low	<input type="checkbox"/>	Privacy	<input type="checkbox"/>	<input type="checkbox"/>	<input type="checkbox"/>	<input type="checkbox"/>	Butt Hinge				

Door Remarks: Staff will be able to unlock from the outside. Door to swing out

Security Grille  
 Anti-barricade strategy

**MILLWORK AND SPECIALTY CASEWORK**

**UPPER UNITS** (U1-U8) **LOWER UNITS** (L1-L12) **RECEPTION/TRANSACTION COUNTER / CARE TEAM STATION DESK** (TC1-TC2) **UTILITY SINK AND COUNTER UNIT** (UC1)

Storage Requirements:  SHELF  S1

Category	Min. Length (mm)	Motorized Adjustable Height	Standing Height	Specialty Casework
2	600	<input type="checkbox"/>	<input type="checkbox"/>	<input type="checkbox"/>

**FINISHES**

Full-height Cabinet:   
 Upper Millwork:   
 Countertop:   
 Lower Millwork:   
 Shelf:

Remarks: Refer to Schedule 1, Section 11 73 00 – X-Y Gantry Ceiling Lift System

**MECHANICAL REQUIREMENTS**

<b>PLUMBING</b> (Quantity) Hand Hygiene Sink: <input type="text"/> Lavatory: <input type="text" value="1"/> Kitchen Sink: <input type="text"/> Seamless Kitchen Sink: <input type="text"/> Utility / Process Sink: <input type="text"/> Scrub Sink: <input type="text"/> Floor Sink: <input type="text"/> Plumbing Remarks: <input type="text" value="Provide bedpan disinfectant"/>	Other Fixtures: <input checked="" type="checkbox"/> Shower <input type="checkbox"/> Tub <input type="checkbox"/> Ice Maker <input checked="" type="checkbox"/> Water Closet <input type="checkbox"/> Instantaneous Hot Water <input type="checkbox"/> Eyewash Station <input type="checkbox"/> Eyewash/Shower Station <input type="checkbox"/> Emergency Shower <input type="checkbox"/> Flush Rim Sink <input checked="" type="checkbox"/> Floor Drain <input type="checkbox"/> Water Bottle Refill Station Other: <input type="text"/>	<b>MED / NON-MED GASES</b> (Quantity) Oxygen: <input type="text"/> Medical Air: <input type="text"/> Medical Vacuum: <input type="text"/> Nitrous Oxide: <input type="text"/> CO2: <input type="text"/> AGSS: <input type="text"/> Nitrogen: <input type="text"/> Laboratory Air: <input type="text"/> Laboratory Vacuum: <input type="text"/> Utility Compressed Air: <input type="text"/> Gas Remarks: <input type="text"/>
---	---	---



**Appendix 1B Minimum Room Requirements**

Room Name:

Program Number(s):

1.	B2.04	7.		13.		19.		25.		31.		37.		43.
2.		8.		14.		20.		26.		32.		38.		44.
3.		9.		15.		21.		27.		33.		39.		45.
4.		10.		16.		22.		28.		34.		40.		46.
5.		11.		17.		23.		29.		35.		41.		47.
6.		12.		18.		24.		30.		36.		42.		48.

**ARCHITECTURAL REQUIREMENTS**

<b>WALL AND CEILING</b> Wall Material: <input type="text" value="MMRGB"/> Finish: <input type="text" value="HPC"/> Ceiling Material: <input type="text" value="MMRGB"/> Finish: <input type="text" value="HPC"/>	<b>WALL PROTECTION</b> Type: <input type="text" value="WSSP"/> <input checked="" type="checkbox"/> Corner Guards <input type="checkbox"/> Hand Rails <input type="checkbox"/> Bed Bumper / Locator Height: <input type="text" value="2185 mm"/> <input type="checkbox"/> Crash Rails <input type="checkbox"/> Chair Rail	<b>GLAZING</b> <input type="checkbox"/> Interior Glazing	<b>FLOORING TYPES</b> Material: <input type="text" value="WSVF"/> Base: <input type="text" value="FCB"/>	<b>ROOM ACCESSORIES</b> <input checked="" type="checkbox"/> Coat Hooks <input checked="" type="checkbox"/> Ceiling Lift <input type="checkbox"/> Magnetic Whiteboard <input checked="" type="checkbox"/> Mirror <input type="checkbox"/> Infant Change Table <input type="checkbox"/> Privacy Curtain
--	--	---	---	---

- LEGEND:**
- WALL AND CEILING LEGEND:**
- AC Architectural Ceiling
  - ACT Acoustic Ceiling Tile
  - ACT-C Cleanroom
  - ARGB Abuse-Resistant Gypsum Board
  - GB Gypsum Board
  - IRGB Impact-Resistant Gypsum Board
  - KLCT Kitchen Lay-in Ceiling Tile
  - MMRGB Moisture and Mould-Resistant Gypsum Board
  - SACT Security Acoustic Ceiling Tile
- WALL FINISHES LEGEND:**
- EWC Epoxy Wall Coating
  - HPC High Performance Coating
  - PT Paint
- CEILING FINISHES LEGEND:**
- ECC Epoxy Ceiling Coating
  - HPC High Performance Coating
  - PF Prefinished
  - PT Paint
- WALL PROTECTION LEGEND:**
- ESRP Extruded Semi-Rigid PVCu Panel
  - FRL Fibre Reinforced Laminate
  - FRP Fibreglass Reinforced Plastic
  - PVV Protective Vinyl Wallcovering
  - RHIS Rigid High Impact Sheet
  - WSSP Wetwall Solid Surface Panel
  - WWW Wetroom Vinyl Wallcovering
- FLOOR FINISHES LEGEND:**
- CFS Concrete Floor Sealer
  - EFC Epoxy Floor Coating
  - PFC Polyurethane Floor Coating
  - RAF Rubber Athletic Flooring
  - RSF Rubber Sheet Flooring
  - SCF Seamless Cushioned Flooring
  - SDRF Static-Dissipative Rubber Sheet Flooring
  - SDVF Static-Dissipative Vinyl Sheet Flooring
  - VSF Vinyl Sheet Flooring
  - WSVF Wetroom Safety Vinyl Sheet Flooring
- FLOOR BASE LEGEND:**
- FCB Flash Cove Base
  - RB Rubber Base
  - SCF Seamless Cushioned Flooring

**DOORS**

Types:

Type	Qty	Size (mm)	Material	Finish	Side Lt.	Blinds	Protect.	Privacy Film	Function	Card Reader	Mag Lock	Auto Opener	Hold Open	Hinges	Accessory 1	Accessory 2	Accessory 3	Closer
A	1	1065 x 2135	Hollow Metal	Paint	<input type="checkbox"/>	<input type="checkbox"/>	1 Low	<input type="checkbox"/>	Privacy	<input type="checkbox"/>	<input type="checkbox"/>	<input type="checkbox"/>	<input type="checkbox"/>	Butt Hinge				Surface

**Door Remarks:**  
 Staff will be able to unlock from the outside.  
 Door to swing out

Security Grille  
 Anti-barricade strategy

**MILLWORK AND SPECIALTY CASEWORK**

**UPPER UNITS** U1 U2 U3 U4 U5 U6 U7 U8

**LOWER UNITS** L1 L2 L3 L4 L5 L6 L7 L8 L9 L10 L11 L12

**RECEPTION/TRANSACTION COUNTER / CARE TEAM STATION DESK** TC1 TC2

**UTILITY SINK AND COUNTER UNIT** UC1

**Storage Requirements:**

**FINISHES**

Full-height Cabinet:

Upper Millwork:

Countertop:

Lower Millwork:

Shelf:

**Remarks:**  
 Refer to Schedule 1, Section 11 73 00 – X-Y Gantry Ceiling Lift System

**Legend:**  
 Category 0 - None  
 Category 1 - Low (1% - 4%)  
 Category 2 - Med (5% - 9%)  
 Category 3 - High (10% or Greater)

Category	Min. Length (mm)	Motorized Adjustable Height	Standing Height	Specialty Casework
2	600	<input type="checkbox"/>	<input type="checkbox"/>	<input type="checkbox"/>

**MECHANICAL REQUIREMENTS**

**PLUMBING**

Hand Hygiene Sink:	Lavatory:	Kitchen Sink:	Seamless Kitchen Sink:	Utility / Process Sink:	Scrub Sink:	Floor Sink:
	1					

Plumbing Remarks:

**Other Fixtures:**

- Shower
- Tub
- Ice Maker
- Water Closet
- Instantaneous Hot Water
- Eyewash Station
- Eyewash/Shower Station
- Emergency Shower
- Flush Rim Sink
- Floor Drain
- Water Bottle Refill Station

Other:

**MED / NON-MED GASES**

Oxygen:	Medical Air:	Medical Vacuum:	Nitrous Oxide:	CO2:	AGSS:	Nitrogen:	Laboratory Air:	Laboratory Vacuum:	Utility Compressed Air:

Gas Remarks:

**Appendix 1B Minimum Room Requirements**

Room Name:

Program Number(s):

1. A2.03	7.	13.	19.	25.	31.	37.	43.
2. G1.03	8.	14.	20.	26.	32.	38.	44.
3. I2.06	9.	15.	21.	27.	33.	39.	45.
4. L2.02	10.	16.	22.	28.	34.	40.	46.
5.	11.	17.	23.	29.	35.	41.	47.
6.	12.	18.	24.	30.	36.	42.	48.

**ARCHITECTURAL REQUIREMENTS**

<b>WALL AND CEILING</b> Wall Material: <input type="text" value="ARGB 1.2m AFF, GB above"/> Finish: <input type="text" value="PT"/> Ceiling Material: <input type="text" value="ACT"/> Finish: <input type="text" value="PF"/>		<b>WALL PROTECTION</b> Type: <input type="text" value="PVW"/> <input checked="" type="checkbox"/> Corner Guards <input type="checkbox"/> Hand Rails <input type="checkbox"/> Bed Bumper / Locator Height: <input type="text" value="1600 mm"/> <input type="checkbox"/> Crash Rails <input type="checkbox"/> Chair Rail		<b>GLAZING</b> <input type="checkbox"/> Interior Glazing		<b>FLOORING TYPES</b> Material: <input type="text" value="VSF"/> Base: <input type="text" value="FCB"/>		<b>ROOM ACCESSORIES</b> <input checked="" type="checkbox"/> Coat Hooks <input checked="" type="checkbox"/> Ceiling Lift <input checked="" type="checkbox"/> Magnetic Whiteboard <input checked="" type="checkbox"/> Mirror <input type="checkbox"/> Infant Change Table <input checked="" type="checkbox"/> Privacy Curtain	
--	--	---	--	---	--	--	--	---	--

- LEGEND:**
- WALL AND CEILING LEGEND:**
- AC Architectural Ceiling
  - ACT Acoustic Ceiling Tile
  - ACT-C Cleanroom
  - ARGB Abuse-Resistant Gypsum Board
  - GB Gypsum Board
  - IRGB Impact-Resistant Gypsum Board
  - KLCT Kitchen Lay-in Ceiling Tile
  - MMRGB Moisture and Mould-Resistant Gypsum Board
  - SACT Security Acoustic Ceiling Tile
- WALL FINISHES LEGEND:**
- EWC Epoxy Wall Coating
  - HPC High Performance Coating
  - PT Paint
- CEILING FINISHES LEGEND:**
- ECC Epoxy Ceiling Coating
  - HPC High Performance Coating
  - PF Prefinished
  - PT Paint
- WALL PROTECTION LEGEND:**
- ESRP Extruded Semi-Rigid PVCu Panel
  - FRL Fibre Reinforced Laminate
  - FRP Fibreglass Reinforced Plastic
  - PVW Protective Vinyl Wallcovering
  - RHIS Rigid High Impact Sheet
  - WSSP Wetwall Solid Surface Panel
  - WWW Wetroom Vinyl Wallcovering
- FLOOR FINISHES LEGEND:**
- CFS Concrete Floor Sealer
  - EFC Epoxy Floor Coating
  - PFC Polyurethane Floor Coating
  - RAF Rubber Athletic Flooring
  - RSF Rubber Sheet Flooring
  - SCF Seamless Cushioned Flooring
  - SDRF Static-Dissipative Rubber Sheet Flooring
  - SDVF Static-Dissipative Vinyl Sheet Flooring
  - VSF Vinyl Sheet Flooring
  - WSVF Wetroom Safety Vinyl Sheet Flooring
- FLOOR BASE LEGEND:**
- FCB Flash Cove Base
  - RB Rubber Base
  - SCF Seamless Cushioned Flooring

**DOORS**

Types:

Note: for Type F doors, the door panels will be approximately 465/1065 unless otherwise required by the Authority

Type	Qty	Size (mm)	Material	Finish	Side Lt.	Blinds	Protect.	Privacy Film	Function	Card Reader	Mag Lock	Auto Opener	Hold Open	Hinges	Accessory 1	Accessory 2	Accessory 3	Closer
F	1	1530 x 2135	Solid Core	FRL	<input type="checkbox"/>	<input type="checkbox"/>	2 High	<input type="checkbox"/>	Passage	<input type="checkbox"/>	<input type="checkbox"/>	<input type="checkbox"/>	<input type="checkbox"/>	Butt Hinge	Astragal	Flush Bolt		

Security Grille  
 Anti-barricade strategy

**MILLWORK AND SPECIALTY CASEWORK**

Storage Requirements:

**UPPER UNITS** (U1-U8)

**LOWER UNITS** (L1-L12)

**RECEPTION/TRANSACTION COUNTER / CARE TEAM STATION DESK** (TC1, TC2)

**UTILITY SINK AND COUNTER UNIT** (UC1)

**SHELF** (S1)

**FULL-HEIGHT CABINETS** (C1-C5)

**Legend:**

Category	Min. Length (mm)	Motorized Adjustable Height	Standing Height	Specialty Casework
Category 0 - None				
Category 1 - Low (1% - 4%)				
Category 2 - Med (5% - 9%)				
Category 3 - High (10% or Greater)				

**FINISHES**

Full-height Cabinet:   
 Upper Millwork:   
 Countertop:   
 Lower Millwork:   
 Shelf:

Remarks:  
 For A2.03 Exam Rooms requirements refer to Schedule 1: Future X-Y Gantry Ceiling Lift Systems  
 Refer to Appendix 1H [Equipment and Furniture] for ceiling lift quantities  
 Provide I2.06 with interior window.

**MECHANICAL REQUIREMENTS**

<b>PLUMBING</b> (Quantity) Hand Hygiene Sink: <input type="text" value="1"/> Lavatory: <input type="text"/> Kitchen Sink: <input type="text"/> Seamless Kitchen Sink: <input type="text"/> Utility / Process Sink: <input type="text"/> Scrub Sink: <input type="text"/> Floor Sink: <input type="text"/> Plumbing Remarks: <input type="text"/>		Other Fixtures: <input type="checkbox"/> Shower <input type="checkbox"/> Tub <input type="checkbox"/> Ice Maker <input type="checkbox"/> Water Closet <input type="checkbox"/> Instantaneous Hot Water <input type="checkbox"/> Eyewash Station <input type="checkbox"/> Eyewash/Shower Station <input type="checkbox"/> Emergency Shower <input type="checkbox"/> Flush Rim Sink <input type="checkbox"/> Floor Drain <input type="checkbox"/> Water Bottle Refill Station Other: <input type="text"/>		<b>MED / NON-MED GASES</b> (Quantity) Oxygen: <input type="text" value="1"/> Medical Air: <input type="text" value="1"/> Medical Vacuum: <input type="text" value="1"/> Nitrous Oxide: <input type="text"/> CO2: <input type="text"/> AGSS: <input type="text"/> Nitrogen: <input type="text"/> Laboratory Air: <input type="text"/> Laboratory Vacuum: <input type="text"/> Utility Compressed Air: <input type="text"/> Gas Remarks: <input type="text" value="Medical gases to Patient's right. I2.06, G1.03, L2.02 does not require Medical Vacuum"/>	
--	--	--	--	--	--

**Appendix 1B Minimum Room Requirements**

Room Name:

Program Number(s):

1. A2.04	7.	13.	19.	25.	31.	37.	43.
2. G1.04	8.	14.	20.	26.	32.	38.	44.
3. L2.03	9.	15.	21.	27.	33.	39.	45.
4.	10.	16.	22.	28.	34.	40.	46.
5.	11.	17.	23.	29.	35.	41.	47.
6.	12.	18.	24.	30.	36.	42.	48.

**ARCHITECTURAL REQUIREMENTS**

<b>WALL AND CEILING</b> Wall Material: <input type="text" value="ARGB 1.2m AFF, GB above"/> Finish: <input type="text" value="PT"/> Ceiling Material: <input type="text" value="ACT"/> Finish: <input type="text" value="PF"/>		<b>WALL PROTECTION</b> Type: <input type="text" value="PVW"/> <input checked="" type="checkbox"/> Corner Guards <input type="checkbox"/> Hand Rails <input type="checkbox"/> Bed Bumper / Locator Height: <input type="text" value="1600 mm"/> <input type="checkbox"/> Crash Rails <input type="checkbox"/> Chair Rail		<b>GLAZING</b> <input type="checkbox"/> Interior Glazing		<b>FLOORING TYPES</b> Material: <input type="text" value="RSF"/> Base: <input type="text" value="FCB"/>		<b>ROOM ACCESSORIES</b> <input checked="" type="checkbox"/> Coat Hooks <input checked="" type="checkbox"/> Ceiling Lift <input checked="" type="checkbox"/> Magnetic Whiteboard <input checked="" type="checkbox"/> Mirror <input type="checkbox"/> Infant Change Table <input checked="" type="checkbox"/> Privacy Curtain	
--	--	---	--	---	--	--	--	---	--

- LEGEND:**
- WALL AND CEILING LEGEND:**
- AC Architectural Ceiling
  - ACT Acoustic Ceiling Tile
  - ACT-C Cleanroom
  - ARGB Abuse-Resistant Gypsum Board
  - GB Gypsum Board
  - IRGB Impact-Resistant Gypsum Board
  - KLCT Kitchen Lay-in Ceiling Tile
  - MMRGB Moisture and Mould-Resistant Gypsum Board
  - SACT Security Acoustic Ceiling Tile
- WALL FINISHES LEGEND:**
- EWC Epoxy Wall Coating
  - HPC High Performance Coating
  - PT Paint
- CEILING FINISHES LEGEND:**
- ECC Epoxy Ceiling Coating
  - HPC High Performance Coating
  - PF Prefinished
  - PT Paint
- WALL PROTECTION LEGEND:**
- ESRP Extruded Semi-Rigid PVCu Panel
  - FRL Fibre Reinforced Laminate
  - FRP Fibreglass Reinforced Plastic
  - PVW Protective Vinyl Wallcovering
  - RHIS Rigid High Impact Sheet
  - WSSP Wetwall Solid Surface Panel
  - WVV Wetroom Vinyl Wallcovering
- FLOOR FINISHES LEGEND:**
- CFS Concrete Floor Sealer
  - EFC Epoxy Floor Coating
  - PFC Polyurethane Floor Coating
  - RAF Rubber Athletic Flooring
  - RSF Rubber Sheet Flooring
  - SCF Seamless Cushioned Flooring
  - SDRF Static-Dissipative Rubber Sheet Flooring
  - SDVF Static-Dissipative Vinyl Sheet Flooring
  - VSF Vinyl Sheet Flooring
  - WSVF Wetroom Safety Vinyl Sheet Flooring
- FLOOR BASE LEGEND:**
- FCB Flash Cove Base
  - RB Rubber Base
  - SCF Seamless Cushioned Flooring

**DOORS**

Types:

Note: for Type F doors, the door panels will be approximately 465/1065 unless otherwise required by the Authority

Door Remarks:  Security Grille  Anti-barricade strategy

Type	Qty	Size (mm)	Material	Finish	Side Lt.	Blinds	Protect.	Privacy Film	Function	Card Reader	Mag Lock	Auto Opener	Hold Open	Hinges	Accessory 1	Accessory 2	Accessory 3	Closer
F	1	1530 x 2135	Solid Core	FRL	<input type="checkbox"/>	<input type="checkbox"/>	2 High	<input type="checkbox"/>	Passage	<input type="checkbox"/>	<input type="checkbox"/>	<input type="checkbox"/>	<input type="checkbox"/>	Butt Hinge	Astragal	Flush Bolt		

**MILLWORK AND SPECIALTY CASEWORK**

Storage Requirements:

**UPPER UNITS** (U1-U8)

**LOWER UNITS** (L1-L12)

**RECEPTION/TRANSACTION COUNTER / CARE TEAM STATION DESK** (TC1, TC2)

**UTILITY SINK AND COUNTER UNIT** (UC1)

**SHELF** (S1)

**FULL-HEIGHT CABINETS** (C1-C5)

**Legend:**

Category	Min. Length (mm)	Motorized Adjustable Height	Standing Height	Specialty Casework
1	900	<input type="checkbox"/>	<input type="checkbox"/>	<input type="checkbox"/>

**FINISHES**

Full-height Cabinet:

Upper Millwork:

Countertop:

Lower Millwork:

Shelf:

Remarks:

**MECHANICAL REQUIREMENTS**

<b>PLUMBING</b> (Quantity) Hygiene Sink: <input type="text" value="1"/> Lavatory: <input type="text"/> Kitchen Sink: <input type="text"/> Seamless Kitchen Sink: <input type="text"/> Utility / Process Sink: <input type="text"/> Scrub Sink: <input type="text"/> Floor Sink: <input type="text"/>							Other Fixtures: <input type="checkbox"/> Shower <input type="checkbox"/> Eyewash Station <input type="checkbox"/> Tub <input type="checkbox"/> Eyewash/Shower Station <input type="checkbox"/> Ice Maker <input type="checkbox"/> Emergency Shower <input type="checkbox"/> Water Closet <input type="checkbox"/> Flush Rim Sink <input type="checkbox"/> Instantaneous Hot Water <input type="checkbox"/> Floor Drain <input type="checkbox"/> <input type="checkbox"/> Water Bottle Refill Station Other: <input type="text"/>				<b>MED / NON-MED GASES</b> (Quantity) Oxygen: <input type="text" value="1"/> Medical Air: <input type="text" value="1"/> Medical Vacuum: <input type="text" value="1"/> Nitrous Oxide: <input type="text"/> CO2: <input type="text"/> AGSS: <input type="text"/> Nitrogen: <input type="text"/> Laboratory Air: <input type="text"/> Laboratory Vacuum: <input type="text"/> Utility Compressed Air: <input type="text"/>					
Plumbing Remarks: <input type="text"/>											Gas Remarks: <input type="text" value="Medical gases to Patient's right. G1.04 and L2.03 does not require Medical Vacuum"/>					



**Appendix 1B Minimum Room Requirements**

Room Name:

Program Number(s):

1. A3.03	7.	13.	19.	25.	31.	37.	43.
2. C3.16	8.	14.	20.	26.	32.	38.	44.
3. C4.12	9.	15.	21.	27.	33.	39.	45.
4. C5.07	10.	16.	22.	28.	34.	40.	46.
5. E8.07	11.	17.	23.	29.	35.	41.	47.
6. G2.02	12.	18.	24.	30.	36.	42.	48.

**ARCHITECTURAL REQUIREMENTS**

<b>WALL AND CEILING</b> Wall Material: <input type="text" value="ARGB 1.2m AFF, GB above"/> Finish: <input type="text" value="PT"/> Ceiling Material: <input type="text" value="ACT"/> Finish: <input type="text" value="PF"/>		<b>WALL PROTECTION</b> Type: <input type="text" value="PVW"/> <input checked="" type="checkbox"/> Corner Guards <input type="checkbox"/> Hand Rails <input type="checkbox"/> Bed Bumper / Locator Height: <input type="text" value="2185 mm"/> <input type="checkbox"/> Crash Rails <input type="checkbox"/> Chair Rail		<b>GLAZING</b> <input type="checkbox"/> Interior Glazing		<b>FLOORING TYPES</b> Material: <input type="text" value="VSF"/> Base: <input type="text" value="FCB"/>		<b>ROOM ACCESSORIES</b> <input checked="" type="checkbox"/> Coat Hooks <input checked="" type="checkbox"/> Ceiling Lift <input checked="" type="checkbox"/> Magnetic Whiteboard <input type="checkbox"/> Mirror <input type="checkbox"/> Infant Change Table <input checked="" type="checkbox"/> Privacy Curtain	
--	--	---	--	---	--	--	--	--	--

- LEGEND:**
- WALL AND CEILING LEGEND:**
- AC Architectural Ceiling
  - ACT Acoustic Ceiling Tile
  - ACT-C Cleanroom
  - ARGB Abuse-Resistant Gypsum Board
  - GB Gypsum Board
  - IRGB Impact-Resistant Gypsum Board
  - KLCT Kitchen Lay-in Ceiling Tile
  - MMRGB Moisture and Mould-Resistant Gypsum Board
  - SACT Security Acoustic Ceiling Tile
- WALL FINISHES LEGEND:**
- EWC Epoxy Wall Coating
  - HPC High Performance Coating
  - PT Paint
- CEILING FINISHES LEGEND:**
- ECC Epoxy Ceiling Coating
  - HPC High Performance Coating
  - PF Prefinished
  - PT Paint
- WALL PROTECTION LEGEND:**
- ESRP Extruded Semi-Rigid PVCu Panel
  - FRL Fibre Reinforced Laminate
  - FRP Fibreglass Reinforced Plastic
  - PVW Protective Vinyl Wallcovering
  - RHIS Rigid High Impact Sheet
  - WSSP Wetwall Solid Surface Panel
  - WVV Wetroom Vinyl Wallcovering
- FLOOR FINISHES LEGEND:**
- CFS Concrete Floor Sealer
  - EFC Epoxy Floor Coating
  - PFC Polyurethane Floor Coating
  - RAF Rubber Athletic Flooring
  - RSF Rubber Sheet Flooring
  - SCF Seamless Cushioned Flooring
  - SDRF Static-Dissipative Rubber Sheet Flooring
  - SDVF Static-Dissipative Vinyl Sheet Flooring
  - VSF Vinyl Sheet Flooring
  - WSVF Wetroom Safety Vinyl Sheet Flooring
- FLOOR BASE LEGEND:**
- FCB Flash Cove Base
  - RB Rubber Base
  - SCF Seamless Cushioned Flooring

**DOORS**

Types:

Type	Qty	Size (mm)	Material	Finish	Side Lt.	Blinds	Protect.	Privacy Film	Function	Card Reader	Mag Lock	Auto Opener	Hold Open	Hinges	Accessory 1	Accessory 2	Accessory 3	Closer
H	1	1340 x 2135	Aluminum	Prefinished	<input type="checkbox"/>	<input type="checkbox"/>		<input type="checkbox"/>		<input type="checkbox"/>	<input type="checkbox"/>	<input type="checkbox"/>	<input type="checkbox"/>					

Door Remarks:  Security Grille  Anti-barricade strategy



**MECHANICAL REQUIREMENTS**

<b>PLUMBING</b> (Quantity) Hand Hygiene Sink: <input type="text" value="1"/> Lavatory: <input type="text"/> Kitchen Sink: <input type="text"/> Seamless Kitchen Sink: <input type="text"/> Utility / Process Sink: <input type="text"/> Scrub Sink: <input type="text"/> Floor Sink: <input type="text"/> Plumbing Remarks: <input type="text"/>		Other Fixtures: <input type="checkbox"/> Shower <input type="checkbox"/> Tub <input type="checkbox"/> Ice Maker <input type="checkbox"/> Water Closet <input type="checkbox"/> Instantaneous Hot Water <input type="checkbox"/> Eyewash Station <input type="checkbox"/> Eyewash/Shower Station <input type="checkbox"/> Emergency Shower <input type="checkbox"/> Flush Rim Sink <input type="checkbox"/> Floor Drain <input type="checkbox"/> Water Bottle Refill Station Other: <input type="text"/>		<b>MED / NON-MED GASES</b> (Quantity) Oxygen: <input type="text" value="4"/> Medical Air: <input type="text" value="2"/> Medical Vacuum: <input type="text" value="4"/> Nitrous Oxide: <input type="text"/> CO2: <input type="text"/> AGSS: <input type="text"/> Nitrogen: <input type="text"/> Laboratory Air: <input type="text"/> Laboratory Vacuum: <input type="text"/> Utility Compressed Air: <input type="text"/> Gas Remarks: <input type="text" value="Provide (2) O2, (1) Medical Air and (2) Medical Vacuum on each side of bed."/>	
--	--	--	--	--	--

# Appendix 1B Minimum Room Requirements

Room Name:

Program Number(s):

1. A3.04	7.	13.	19.	25.	31.	37.	43.
2. C4.08	8.	14.	20.	26.	32.	38.	44.
3. G1.26	9.	15.	21.	27.	33.	39.	45.
4. G2.05	10.	16.	22.	28.	34.	40.	46.
5. I2.07	11.	17.	23.	29.	35.	41.	47.
6. L2.04	12.	18.	24.	30.	36.	42.	48.

## ARCHITECTURAL REQUIREMENTS

<b>WALL AND CEILING</b> Wall Material: <input type="text" value="ARGB 1.2m AFF, GB above"/> Finish: <input type="text" value="EWC"/> Ceiling Material: <input type="text" value="GB"/> Finish: <input type="text" value="ECC"/>		<b>WALL PROTECTION</b> Type: <input type="text" value="PVW"/> <input checked="" type="checkbox"/> Corner Guards <input type="checkbox"/> Hand Rails <input type="checkbox"/> Bed Bumper / Locator Height: <input type="text" value="2185 mm"/> <input type="checkbox"/> Crash Rails <input type="checkbox"/> Chair Rail		<b>GLAZING</b> <input type="checkbox"/> Interior Glazing		<b>FLOORING TYPES</b> Material: <input type="text" value="VSF"/> Base: <input type="text" value="FCB"/>		<b>ROOM ACCESSORIES</b> <input checked="" type="checkbox"/> Coat Hooks <input checked="" type="checkbox"/> Ceiling Lift <input checked="" type="checkbox"/> Magnetic Whiteboard <input type="checkbox"/> Mirror <input type="checkbox"/> Infant Change Table <input checked="" type="checkbox"/> Privacy Curtain	
---	--	---	--	---	--	--	--	--	--

- LEGEND:**
- WALL AND CEILING LEGEND:**
- AC Architectural Ceiling
  - ACT Acoustic Ceiling Tile
  - ACT-C Cleanroom
  - ARGB Abuse-Resistant Gypsum Board
  - GB Gypsum Board
  - IRGB Impact-Resistant Gypsum Board
  - KLCT Kitchen Lay-in Ceiling Tile
  - MMRGB Moisture and Mould-Resistant Gypsum Board
  - SACT Security Acoustic Ceiling Tile
- WALL FINISHES LEGEND:**
- EWC Epoxy Wall Coating
  - HPC High Performance Coating
  - PT Paint
- CEILING FINISHES LEGEND:**
- ECC Epoxy Ceiling Coating
  - HPC High Performance Coating
  - PF Prefinished
  - PT Paint
- WALL PROTECTION LEGEND:**
- ESRP Extruded Semi-Rigid PVCu Panel
  - FRL Fibre Reinforced Laminate
  - FRP Fibreglass Reinforced Plastic
  - PVW Protective Vinyl Wallcovering
  - RHIS Rigid High Impact Sheet
  - WSSP Wetwall Solid Surface Panel
  - WVV Wetroom Vinyl Wallcovering
- FLOOR FINISHES LEGEND:**
- CFS Concrete Floor Sealer
  - EFC Epoxy Floor Coating
  - PFC Polyurethane Floor Coating
  - RAF Rubber Athletic Flooring
  - RSF Rubber Sheet Flooring
  - SCF Seamless Cushioned Flooring
  - SDRF Static-Dissipative Rubber Sheet Flooring
  - SDVF Static-Dissipative Vinyl Sheet Flooring
  - VSF Vinyl Sheet Flooring
  - WSVF Wetroom Safety Vinyl Sheet Flooring
- FLOOR BASE LEGEND:**
- FCB Flash Cove Base
  - RB Rubber Base
  - SCF Seamless Cushioned Flooring

**DOORS**

Types:

Note: for Type F doors, the door panels will be approximately 465/1065 unless otherwise required by the Authority

Door Remarks: Provide Type F2 door with a half window (sim to Type B). Provide I2.07 with H type door.

Type	Qty	Size (mm)	Material	Finish	Side Lt	Blinds	Protect	Privacy Film	Function	Card Reader	Mag Lock	Auto Opener	Hold Open	Hinges	Accessory 1	Accessory 2	Accessory 3	Closer
F2	1	1530 x 2135	Solid Core	FRL	<input type="checkbox"/>	<input type="checkbox"/>	2 High	<input type="checkbox"/>	Passage	<input type="checkbox"/>	<input type="checkbox"/>	<input type="checkbox"/>	<input type="checkbox"/>	Butt Hinge	Astragal	Flush Bolt		Surface

Security Grille  
 Anti-barricade strategy

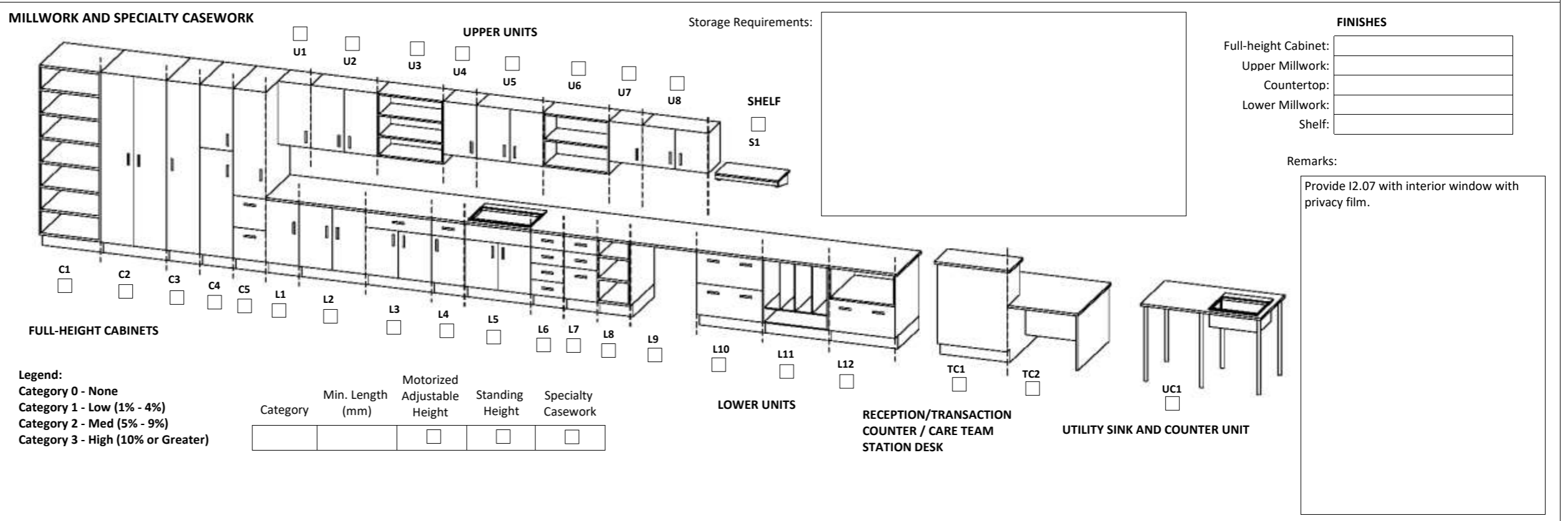

## MECHANICAL REQUIREMENTS

<b>PLUMBING</b> (Quantity)		Hand Hygiene Sink: <input type="text" value="1"/> Lavatory: <input type="text"/> Kitchen Sink: <input type="text"/> Seamless Kitchen Sink: <input type="text"/> Utility / Process Sink: <input type="text"/> Scrub Sink: <input type="text"/> Floor Sink: <input type="text"/>							Other Fixtures: <input type="checkbox"/> Shower <input type="checkbox"/> Eyewash Station <input type="checkbox"/> Tub <input type="checkbox"/> Eyewash/Shower Station <input type="checkbox"/> Ice Maker <input type="checkbox"/> Emergency Shower <input type="checkbox"/> Water Closet <input type="checkbox"/> Flush Rim Sink <input type="checkbox"/> Instantaneous Hot Water <input type="checkbox"/> Floor Drain <input type="checkbox"/> <input type="checkbox"/> Water Bottle Refill Station Other <input type="text"/>				<b>MED / NON-MED GASES</b> (Quantity)						Laboratory Air: <input type="text"/> Laboratory Vacuum: <input type="text"/> Utility Compressed Air: <input type="text"/>	
Plumbing Remarks: <input type="text"/>		Oxygen: <input type="text" value="4"/> Medical Air: <input type="text" value="2"/> Medical Vacuum: <input type="text" value="4"/> Nitrous Oxide: <input type="text"/> CO2: <input type="text"/> AGSS: <input type="text"/> Nitrogen: <input type="text"/>		Gas Remarks: Provide (2) O2, (1) Medical Air and (2) Medical Vacuum on each side of bed.																

**Appendix 1B Minimum Room Requirements**

Room Name: Exam/Treatment Room - AIR - Bariatric

Program Number(s):

1. C3.13	7.	13.	19.	25.	31.	37.	43.
2. D6.06	8.	14.	20.	26.	32.	38.	44.
3. G2.08	9.	15.	21.	27.	33.	39.	45.
4.	10.	16.	22.	28.	34.	40.	46.
5.	11.	17.	23.	29.	35.	41.	47.
6.	12.	18.	24.	30.	36.	42.	48.

**ARCHITECTURAL REQUIREMENTS**

<b>WALL AND CEILING</b> Wall Material: ARGB 1.2m AFF, GB above Ceiling Material: GB Finish: EWC Finish: ECC		<b>WALL PROTECTION</b> Type: PVW Height: 2185 mm <input checked="" type="checkbox"/> Corner Guards <input type="checkbox"/> Hand Rails <input type="checkbox"/> Bed Bumper / Locator <input type="checkbox"/> Crash Rails <input type="checkbox"/> Chair Rail		<b>GLAZING</b> <input type="checkbox"/> Interior Glazing		<b>FLOORING TYPES</b> Material: VSF Base: FCB		<b>ROOM ACCESSORIES</b> <input checked="" type="checkbox"/> Coat Hooks <input type="checkbox"/> Mirror <input checked="" type="checkbox"/> Ceiling Lift <input type="checkbox"/> Infant Change Table <input checked="" type="checkbox"/> Magnetic Whiteboard <input checked="" type="checkbox"/> Privacy Curtain	
---	--	--	--	---	--	---	--	--	--

- LEGEND:**
- WALL AND CEILING LEGEND:**
- AC Architectural Ceiling
  - ACT Acoustic Ceiling Tile
  - ACT-C Cleanroom
  - ARGB Abuse-Resistant Gypsum Board
  - GB Gypsum Board
  - IRGB Impact-Resistant Gypsum Board
  - KLCT Kitchen Lay-in Ceiling Tile
  - MMRGB Moisture and Mould-Resistant Gypsum Board
  - SACT Security Acoustic Ceiling Tile
- WALL FINISHES LEGEND:**
- EWC Epoxy Wall Coating
  - HPC High Performance Coating
  - PT Paint
- CEILING FINISHES LEGEND:**
- ECC Epoxy Ceiling Coating
  - HPC High Performance Coating
  - PF Prefinished
  - PT Paint
- WALL PROTECTION LEGEND:**
- ESRP Extruded Semi-Rigid PVCu Panel
  - FRL Fibre Reinforced Laminate
  - FRP Fibreglass Reinforced Plastic
  - PVW Protective Vinyl Wallcovering
  - RHIS Rigid High Impact Sheet
  - WSSP Wetwall Solid Surface Panel
  - WVV Wetroom Vinyl Wallcovering
- FLOOR FINISHES LEGEND:**
- CFS Concrete Floor Sealer
  - EFC Epoxy Floor Coating
  - PFC Polyurethane Floor Coating
  - RAF Rubber Athletic Flooring
  - RSF Rubber Sheet Flooring
  - SCF Seamless Cushioned Flooring
  - SDRF Static-Dissipative Rubber Sheet Flooring
  - SDVF Static-Dissipative Vinyl Sheet Flooring
  - VSF Vinyl Sheet Flooring
  - WSVF Wetroom Safety Vinyl Sheet Flooring
- FLOOR BASE LEGEND:**
- FCB Flash Cove Base
  - RB Rubber Base
  - SCF Seamless Cushioned Flooring

**DOORS**

Types:

Note: for Type F doors, the door panels will be approximately 465/1065 unless otherwise required by the Authority

Door Remarks: Provide Type F2 door with a half window (sim to Type B).

Type	Qty	Size (mm)	Material	Finish	Side Lt	Blinds	Protect	Privacy Film	Function	Card Reader	Mag Lock	Auto Opener	Hold Open	Hinges	Accessory 1	Accessory 2	Accessory 3	Closer
F2	1	1530 x 2135	Solid Core	FRL			2 High		Passage					Butt Hinge	Astragal	Flush Bolt		Concealed

Security Grille  
 Anti-barricade strategy

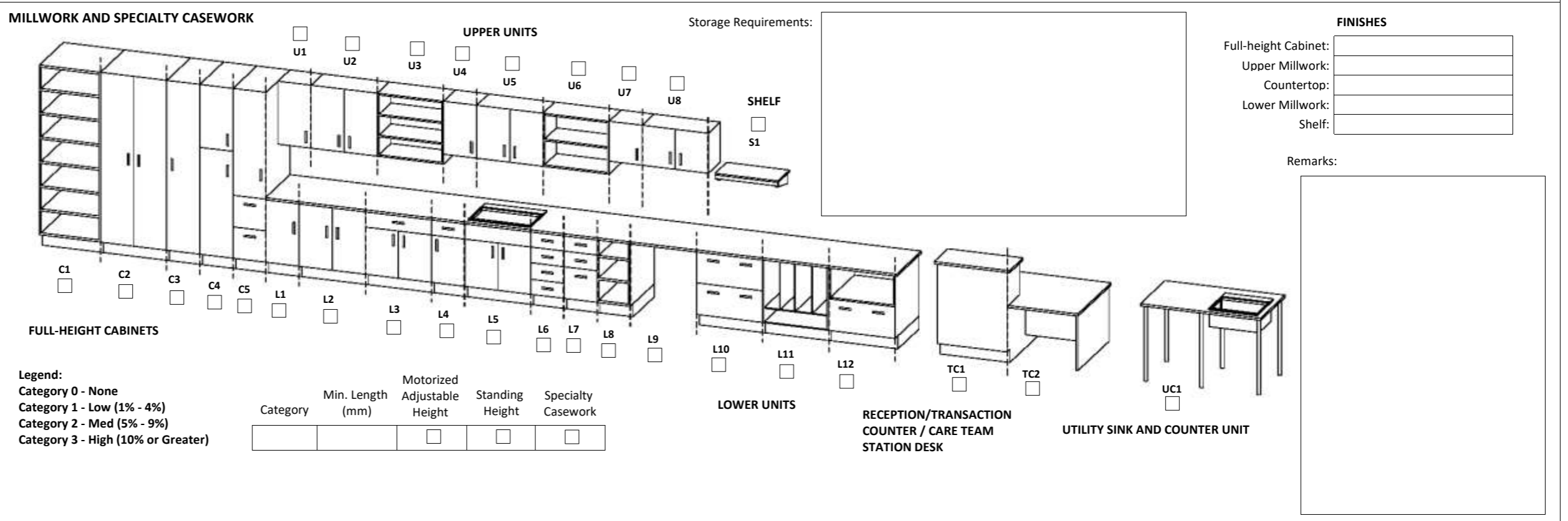

**MECHANICAL REQUIREMENTS**

<b>PLUMBING</b> (Quantity) Hand Hygiene Sink: 1 Lavatory: _____ Kitchen Sink: _____ Seamless Kitchen Sink: _____ Utility / Process Sink: _____ Scrub Sink: _____ Floor Sink: _____ Plumbing Remarks: _____							<b>Other Fixtures:</b> <input type="checkbox"/> Shower <input type="checkbox"/> Tub <input type="checkbox"/> Ice Maker <input type="checkbox"/> Water Closet <input type="checkbox"/> Instantaneous Hot Water <input type="checkbox"/> Eyewash Station <input type="checkbox"/> Eyewash/Shower Station <input type="checkbox"/> Emergency Shower <input type="checkbox"/> Flush Rim Sink <input type="checkbox"/> Floor Drain <input type="checkbox"/> Water Bottle Refill Station Other: _____				<b>MED / NON-MED GASES</b> (Quantity) Oxygen: 4 Medical Air: 2 Medical Vacuum: 4 Nitrous Oxide: _____ CO2: _____ AGSS: _____ Nitrogen: _____ Laboratory Air: _____ Laboratory Vacuum: _____ Utility Compressed Air: _____ Gas Remarks: Provide (2) O2, (1) Medical Air, (2) Medical Vacuum on each side of bed.					
---	--	--	--	--	--	--	---	--	--	--	---	--	--	--	--	--



**Appendix 1B Minimum Room Requirements**

Room Name: Exam/Treatment Room - Bariatric

Program Number(s):

1. A3.07	7.	13.	19.	25.	31.	37.	43.
2. C3.18	8.	14.	20.	26.	32.	38.	44.
3. C4.13	9.	15.	21.	27.	33.	39.	45.
4.	10.	16.	22.	28.	34.	40.	46.
5.	11.	17.	23.	29.	35.	41.	47.
6.	12.	18.	24.	30.	36.	42.	48.

**ARCHITECTURAL REQUIREMENTS**

<b>WALL AND CEILING</b> Wall Material: ARGB 1.2m AFF, GB above Ceiling Material: ACT Finish: PT Finish: PF	<b>WALL PROTECTION</b> Type: PVW Height: 2185 mm <input checked="" type="checkbox"/> Corner Guards <input type="checkbox"/> Hand Rails <input type="checkbox"/> Bed Bumper / Locator <input type="checkbox"/> Crash Rails <input type="checkbox"/> Chair Rail	<b>GLAZING</b> <input type="checkbox"/> Interior Glazing	<b>FLOORING TYPES</b> Material: VSF Base: FCB	<b>ROOM ACCESSORIES</b> <input checked="" type="checkbox"/> Coat Hooks <input type="checkbox"/> Mirror <input checked="" type="checkbox"/> Ceiling Lift <input type="checkbox"/> Infant Change Table <input checked="" type="checkbox"/> Magnetic Whiteboard <input checked="" type="checkbox"/> Privacy Curtain
--	--	---	---	--

- LEGEND:**
- WALL AND CEILING LEGEND:**
- AC Architectural Ceiling
  - ACT Acoustic Ceiling Tile
  - ACT-C Cleanroom
  - ARGB Abuse-Resistant Gypsum Board
  - GB Gypsum Board
  - IRGB Impact-Resistant Gypsum Board
  - KLCT Kitchen Lay-in Ceiling Tile
  - MMRGB Moisture and Mould-Resistant Gypsum Board
  - SACT Security Acoustic Ceiling Tile
- WALL FINISHES LEGEND:**
- EWC Epoxy Wall Coating
  - HPC High Performance Coating
  - PT Paint
- CEILING FINISHES LEGEND:**
- ECC Epoxy Ceiling Coating
  - HPC High Performance Coating
  - PF Prefinished
  - PT Paint
- WALL PROTECTION LEGEND:**
- ESRP Extruded Semi-Rigid PVCu Panel
  - FRL Fibre Reinforced Laminate
  - FRP Fibreglass Reinforced Plastic
  - PVW Protective Vinyl Wallcovering
  - RHIS Rigid High Impact Sheet
  - WSSP Wetwall Solid Surface Panel
  - WVV Wetroom Vinyl Wallcovering
- FLOOR FINISHES LEGEND:**
- CFS Concrete Floor Sealer
  - EFC Epoxy Floor Coating
  - PFC Polyurethane Floor Coating
  - RAF Rubber Athletic Flooring
  - RSF Rubber Sheet Flooring
  - SCF Seamless Cushioned Flooring
  - SDRF Static-Dissipative Rubber Sheet Flooring
  - SDVF Static-Dissipative Vinyl Sheet Flooring
  - VSF Vinyl Sheet Flooring
  - WSVF Wetroom Safety Vinyl Sheet Flooring
- FLOOR BASE LEGEND:**
- FCB Flash Cove Base
  - RB Rubber Base
  - SCF Seamless Cushioned Flooring

**DOORS**

Types:

Type	Qty	Size (mm)	Material	Finish	Side Lt.	Blinds	Protect.	Privacy Film	Function	Card Reader	Mag Lock	Auto Opener	Hold Open	Hinges	Accessory 1	Accessory 2	Accessory 3	Closer
H	1	1340 x 2135	Aluminum	Prefinished	<input type="checkbox"/>	<input type="checkbox"/>		<input type="checkbox"/>		<input type="checkbox"/>	<input type="checkbox"/>	<input type="checkbox"/>	<input type="checkbox"/>					

Door Remarks:

Security Grille  
 Anti-barricade strategy



**MECHANICAL REQUIREMENTS**

<b>PLUMBING</b> (Quantity) Hand Hygiene Sink: 1 Lavatory: _____ Kitchen Sink: _____ Seamless Kitchen Sink: _____ Utility / Process Sink: _____ Scrub Sink: _____ Floor Sink: _____ Plumbing Remarks: _____	Other Fixtures: <input type="checkbox"/> Shower <input type="checkbox"/> Tub <input type="checkbox"/> Ice Maker <input type="checkbox"/> Water Closet <input type="checkbox"/> Instantaneous Hot Water <input type="checkbox"/> Eyewash Station <input type="checkbox"/> Eyewash/Shower Station <input type="checkbox"/> Emergency Shower <input type="checkbox"/> Flush Rim Sink <input type="checkbox"/> Floor Drain <input type="checkbox"/> Water Bottle Refill Station Other: _____	<b>MED / NON-MED GASES</b> (Quantity) Oxygen: 4 Medical Air: 2 Medical Vacuum: 4 Nitrous Oxide: _____ CO2: _____ AGSS: _____ Nitrogen: _____ Laboratory Air: _____ Laboratory Vacuum: _____ Utility Compressed Air: _____ Gas Remarks: Provide (2) O2, (1) Medical Air, (2) Medical Vacuum on each side of bed.
---	--	---

**Appendix 1B Minimum Room Requirements**

Room Name:

Program Number(s):

1. G1.10	7.	13.	19.	25.	31.	37.	43.
2. V1.01	8.	14.	20.	26.	32.	38.	44.
3.	9.	15.	21.	27.	33.	39.	45.
4.	10.	16.	22.	28.	34.	40.	46.
5.	11.	17.	23.	29.	35.	41.	47.
6.	12.	18.	24.	30.	36.	42.	48.

**ARCHITECTURAL REQUIREMENTS**

<b>WALL AND CEILING</b> Wall Material: <input type="text" value="GB"/> Finish: <input type="text" value="PT"/> Ceiling Material: <input type="text" value="ACT"/> Finish: <input type="text" value="PF"/>	<b>WALL PROTECTION</b> Type: <input type="text"/> Height: <input type="text"/> <input checked="" type="checkbox"/> Corner Guards <input type="checkbox"/> Hand Rails <input type="checkbox"/> Bed Bumper / Locator <input type="checkbox"/> Crash Rails <input checked="" type="checkbox"/> Chair Rail	<b>GLAZING</b> <input type="checkbox"/> Interior Glazing	<b>FLOORING TYPES</b> Material: <input type="text" value="RSF"/> Base: <input type="text" value="FCB"/>	<b>ROOM ACCESSORIES</b> <input type="checkbox"/> Coat Hooks <input type="checkbox"/> Ceiling Lift <input checked="" type="checkbox"/> Magnetic Whiteboard <input type="checkbox"/> Mirror <input type="checkbox"/> Infant Change Table <input type="checkbox"/> Privacy Curtain
---	---	---	--	---

- LEGEND:**
- WALL AND CEILING LEGEND:**
- AC Architectural Ceiling
  - ACT Acoustic Ceiling Tile
  - ACT-C Cleanroom
  - ARGB Abuse-Resistant Gypsum Board
  - GB Gypsum Board
  - IRGB Impact-Resistant Gypsum Board
  - KLCT Kitchen Lay-in Ceiling Tile
  - MMRGB Moisture and Mould-Resistant Gypsum Board
  - SACT Security Acoustic Ceiling Tile
- WALL FINISHES LEGEND:**
- EWC Epoxy Wall Coating
  - HPC High Performance Coating
  - PT Paint
- CEILING FINISHES LEGEND:**
- ECC Epoxy Ceiling Coating
  - HPC High Performance Coating
  - PF Prefinished
  - PT Paint
- WALL PROTECTION LEGEND:**
- ESRP Extruded Semi-Rigid PVCu Panel
  - FRL Fibre Reinforced Laminate
  - FRP Fibreglass Reinforced Plastic
  - PVV Protective Vinyl Wallcovering
  - RHIS Rigid High Impact Sheet
  - WSSP Wetwall Solid Surface Panel
  - WVV Wetroom Vinyl Wallcovering
- FLOOR FINISHES LEGEND:**
- CFS Concrete Floor Sealer
  - EFC Epoxy Floor Coating
  - PFC Polyurethane Floor Coating
  - RAF Rubber Athletic Flooring
  - RSF Rubber Sheet Flooring
  - SCF Seamless Cushioned Flooring
  - SDRF Static-Dissipative Rubber Sheet Flooring
  - SDVF Static-Dissipative Vinyl Sheet Flooring
  - VSF Vinyl Sheet Flooring
  - WSVF Wetroom Safety Vinyl Sheet Flooring
- FLOOR BASE LEGEND:**
- FCB Flash Cove Base
  - RB Rubber Base
  - SCF Seamless Cushioned Flooring

**DOORS**

Types:

Type	Qty	Size (mm)	Material	Finish	Side Lt	Blinds	Protect	Privacy Film	Function	Card Reader	Mag Lock	Auto Opener	Hold Open	Hinges	Accessory 1	Accessory 2	Accessory 3	Closer
C	1	1065 x 2135	Solid Core	FRL	<input type="checkbox"/>	<input type="checkbox"/>	1 Low	<input type="checkbox"/>	Storeroom	<input checked="" type="checkbox"/>	<input type="checkbox"/>	<input type="checkbox"/>	<input type="checkbox"/>	Butt Hinge				

Door Remarks:

Security Grille  
 Anti-barricade strategy

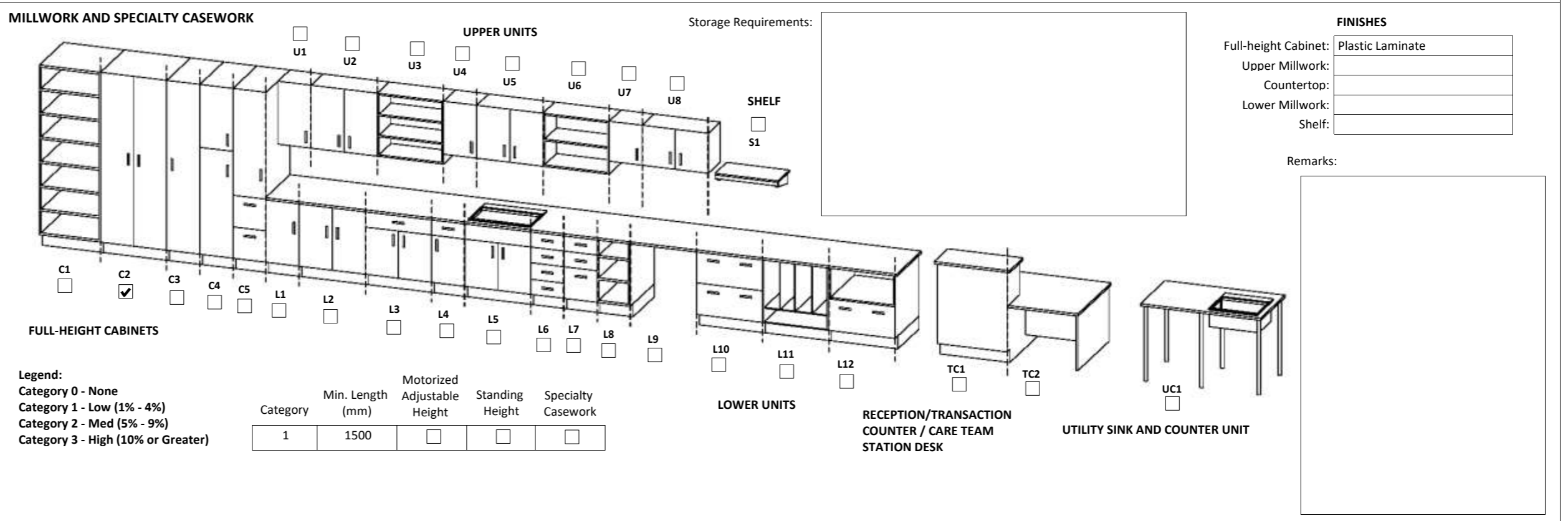

**MECHANICAL REQUIREMENTS**

<b>PLUMBING</b> (Quantity) Hand Hygiene Sink: <input type="text"/> Lavatory: <input type="text"/> Kitchen Sink: <input type="text"/> Seamless Kitchen Sink: <input type="text"/> Utility / Process Sink: <input type="text"/> Scrub Sink: <input type="text"/> Floor Sink: <input type="text"/> Plumbing Remarks: <input type="text"/>	Other Fixtures: <input type="checkbox"/> Shower <input type="checkbox"/> Tub <input type="checkbox"/> Ice Maker <input type="checkbox"/> Water Closet <input type="checkbox"/> Instantaneous Hot Water <input type="checkbox"/> Eyewash Station <input type="checkbox"/> Eyewash/Shower Station <input type="checkbox"/> Emergency Shower <input type="checkbox"/> Flush Rim Sink <input type="checkbox"/> Floor Drain <input type="checkbox"/> Water Bottle Refill Station Other: <input type="text"/>	<b>MED / NON-MED GASES</b> (Quantity) Oxygen: <input type="text"/> Medical Air: <input type="text"/> Medical Vacuum: <input type="text"/> Nitrous Oxide: <input type="text"/> CO2: <input type="text"/> AGSS: <input type="text"/> Nitrogen: <input type="text"/> Laboratory Air: <input type="text"/> Laboratory Vacuum: <input type="text"/> Utility Compressed Air: <input type="text"/> Gas Remarks: <input type="text"/>
--	--	---

# Appendix 1B Minimum Room Requirements

Room Name:

Program Number(s):

1. M2.14	7.	13.	19.	25.	31.	37.	43.
2. M2.29	8.	14.	20.	26.	32.	38.	44.
3.	9.	15.	21.	27.	33.	39.	45.
4.	10.	16.	22.	28.	34.	40.	46.
5.	11.	17.	23.	29.	35.	41.	47.
6.	12.	18.	24.	30.	36.	42.	48.

## ARCHITECTURAL REQUIREMENTS

<b>WALL AND CEILING</b> Wall Material: <input type="text" value="ARGB 1.2m AFF, GB above"/> Finish: <input type="text" value="PT"/> Ceiling Material: <input type="text" value="ACT"/> Finish: <input type="text" value="PF"/>		<b>WALL PROTECTION</b> Type: <input type="text" value="FRP"/> <input checked="" type="checkbox"/> Corner Guards <input type="checkbox"/> Hand Rails <input type="checkbox"/> Bed Bumper / Locator Height: <input type="text" value="1600 mm"/> <input type="checkbox"/> Crash Rails <input type="checkbox"/> Chair Rail		<b>GLAZING</b> <input type="checkbox"/> Interior Glazing		<b>FLOORING TYPES</b> Material: <input type="text" value="VSF"/> Base: <input type="text" value="FCB"/>		<b>ROOM ACCESSORIES</b> <input type="checkbox"/> Coat Hooks <input checked="" type="checkbox"/> Ceiling Lift <input type="checkbox"/> Magnetic Whiteboard <input type="checkbox"/> Mirror <input type="checkbox"/> Infant Change Table <input type="checkbox"/> Privacy Curtain	
--	--	---	--	---	--	--	--	---	--

- LEGEND:**
- WALL AND CEILING LEGEND:**
- AC Architectural Ceiling
  - ACT Acoustic Ceiling Tile
  - ACT-C Cleanroom
  - ARGB Abuse-Resistant Gypsum Board
  - GB Gypsum Board
  - IRGB Impact-Resistant Gypsum Board
  - KLCT Kitchen Lay-in Ceiling Tile
  - MMRGB Moisture and Mould-Resistant Gypsum Board
  - SACT Security Acoustic Ceiling Tile
- WALL FINISHES LEGEND:**
- EWC Epoxy Wall Coating
  - HPC High Performance Coating
  - PT Paint
- CEILING FINISHES LEGEND:**
- ECC Epoxy Ceiling Coating
  - HPC High Performance Coating
  - PF Prefinished
  - PT Paint
- WALL PROTECTION LEGEND:**
- ESRP Extruded Semi-Rigid PVCu Panel
  - FRL Fibre Reinforced Laminate
  - FRP Fibreglass Reinforced Plastic
  - PVV Protective Vinyl Wallcovering
  - RHIS Rigid High Impact Sheet
  - WSSP Wetwall Solid Surface Panel
  - WWW Wetroom Vinyl Wallcovering
- FLOOR FINISHES LEGEND:**
- CFS Concrete Floor Sealer
  - EFC Epoxy Floor Coating
  - PFC Polyurethane Floor Coating
  - RAF Rubber Athletic Flooring
  - RSF Rubber Sheet Flooring
  - SCF Seamless Cushioned Flooring
  - SDRF Static-Dissipative Rubber Sheet Flooring
  - SDVF Static-Dissipative Vinyl Sheet Flooring
  - VSF Vinyl Sheet Flooring
  - WSVF Wetroom Safety Vinyl Sheet Flooring
- FLOOR BASE LEGEND:**
- FCB Flash Cove Base
  - RB Rubber Base
  - SCF Seamless Cushioned Flooring

**DOORS**

Types:

Type	Qty	Size (mm)	Material	Finish	Side Lt.	Blinds	Protect.	Privacy Film	Function	Card Reader	Mag Lock	Auto Opener	Hold Open	Hinges	Accessory 1	Accessory 2	Accessory 3	Closer
A	1	1065 x 2135	Solid Core	FRL	<input type="checkbox"/>	<input type="checkbox"/>	2 High	<input type="checkbox"/>	Storeroom	<input checked="" type="checkbox"/>	<input type="checkbox"/>	<input type="checkbox"/>	<input type="checkbox"/>	Butt Hinge				Surface

Door Remarks:

Security Grille  
 Anti-barricade strategy

**MILLWORK AND SPECIALTY CASEWORK**

Storage Requirements:

**UPPER UNITS** (U1-U8)

**LOWER UNITS** (L1-L12)

**RECEPTION/TRANSACTION COUNTER / CARE TEAM STATION DESK** (TC1, TC2)

**UTILITY SINK AND COUNTER UNIT** (UC1)

**SHELF** (S1)

**FULL-HEIGHT CABINETS** (C1-C5)

**Legend:**

Category	Min. Length (mm)	Motorized Adjustable Height	Standing Height	Specialty Casework
Category 0 - None				
Category 1 - Low (1% - 4%)				
Category 2 - Med (5% - 9%)				
Category 3 - High (10% or Greater)				

Remarks: Refer to Schedule 1, Section 6.13 (Division 13) for shielded chamber requirements. Provide hole to allow for access to the Dose Calibrator below the L9 counter. Counter to withstand excessive weight. Provide single track lift for M2.14.

## MECHANICAL REQUIREMENTS

<b>PLUMBING</b> (Quantity) Hand Hygiene Sink: <input type="text"/> Lavatory: <input type="text"/> Kitchen Sink: <input type="text"/> Seamless Kitchen Sink: <input type="text"/> Utility / Process Sink: <input type="text" value="1"/> Scrub Sink: <input type="text"/> Floor Sink: <input type="text"/>		Other Fixtures: <input type="checkbox"/> Shower <input type="checkbox"/> Eyewash Station <input type="checkbox"/> Tub <input type="checkbox"/> Eyewash/Shower Station <input type="checkbox"/> Ice Maker <input type="checkbox"/> Emergency Shower <input type="checkbox"/> Water Closet <input type="checkbox"/> Flush Rim Sink <input type="checkbox"/> Instantaneous Hot Water <input type="checkbox"/> Floor Drain <input type="checkbox"/> Water Bottle Refill Station Other: <input type="text"/>		<b>MED / NON-MED GASES</b> (Quantity) Oxygen: <input type="text"/> Medical Air: <input type="text"/> Medical Vacuum: <input type="text"/> Nitrous Oxide: <input type="text"/> CO2: <input type="text"/> AGSS: <input type="text"/> Nitrogen: <input type="text"/> Laboratory Air: <input type="text"/> Laboratory Vacuum: <input type="text"/> Utility Compressed Air: <input type="text"/>	
Plumbing Remarks: <input type="text" value="Provide integral sink for M2.14 and M2.29"/>		Gas Remarks: <input type="text"/>			



**Appendix 1B Minimum Room Requirements**

Room Name:

Program Number(s):

1. A4.11	7. D3.13	13. I2.22	19. P1.09	25. T2.08	31.	37.	43.
2. B1.16	8. D6.22	14. J4.07	20. P2.04	26. U7.03	32.	38.	44.
3. B2.23	9. D7.16	15. L1.18	21. P4.10	27. V1.12	33.	39.	45.
4. B3.23	10. E6.04	16. M1.12	22. Q2.01	28. X3.05	34.	40.	46.
5. C6.03	11. F7.11	17. M1.21	23. R3.09	29. Y1.15	35.	41.	47.
6. D2.27	12. G1.20	18. M2.12	24. R4.08	30. Y4.05	36.	42.	48.

**ARCHITECTURAL REQUIREMENTS**

<b>WALL AND CEILING</b> Wall Material: <input type="text" value="ARGB 1.2m AFF, GB above"/> Finish: <input type="text" value="EWC"/> Ceiling Material: <input type="text" value="ACT"/> Finish: <input type="text" value="PF"/>		<b>WALL PROTECTION</b> Type: <input type="text" value="WVV"/> <input checked="" type="checkbox"/> Corner Guards <input type="checkbox"/> Hand Rails <input type="checkbox"/> Bed Bumper / Locator Height: <input type="text" value="2185 mm"/> <input type="checkbox"/> Crash Rails <input type="checkbox"/> Chair Rail			<b>GLAZING</b> <input type="checkbox"/> Interior Glazing		<b>FLOORING TYPES</b> Material: <input type="text" value="WSVF"/> Base: <input type="text" value="FCB"/>		<b>ROOM ACCESSORIES</b> <input type="checkbox"/> Coat Hooks <input type="checkbox"/> Ceiling Lift <input type="checkbox"/> Magnetic Whiteboard <input type="checkbox"/> Mirror <input type="checkbox"/> Infant Change Table <input type="checkbox"/> Privacy Curtain		
---	--	---	--	--	---	--	---	--	--	--	--

- LEGEND:**
- WALL AND CEILING LEGEND:**
- AC Architectural Ceiling
  - ACT Acoustic Ceiling Tile
  - ACT-C Cleanroom
  - ARGB Abuse-Resistant Gypsum Board
  - GB Gypsum Board
  - IRGB Impact-Resistant Gypsum Board
  - KLCT Kitchen Lay-in Ceiling Tile
  - MMRGB Moisture and Mould-Resistant Gypsum Board
  - SACT Security Acoustic Ceiling Tile
- WALL FINISHES LEGEND:**
- EWC Epoxy Wall Coating
  - HPC High Performance Coating
  - PT Paint
- CEILING FINISHES LEGEND:**
- ECC Epoxy Ceiling Coating
  - HPC High Performance Coating
  - PF Prefinished
  - PT Paint
- WALL PROTECTION LEGEND:**
- ESRP Extruded Semi-Rigid PVCu Panel
  - FRL Fibre Reinforced Laminate
  - FRP Fibreglass Reinforced Plastic
  - PVV Protective Vinyl Wallcovering
  - RHIS Rigid High Impact Sheet
  - WSSP Wetwall Solid Surface Panel
  - WVV Wetroom Vinyl Wallcovering
- FLOOR FINISHES LEGEND:**
- CFS Concrete Floor Sealer
  - EFC Epoxy Floor Coating
  - PFC Polyurethane Floor Coating
  - RAF Rubber Athletic Flooring
  - RSF Rubber Sheet Flooring
  - SCF Seamless Cushioned Flooring
  - SDRF Static-Dissipative Rubber Sheet Flooring
  - SDVF Static-Dissipative Vinyl Sheet Flooring
  - VSF Vinyl Sheet Flooring
  - WSVF Wetroom Safety Vinyl Sheet Flooring
- FLOOR BASE LEGEND:**
- FCB Flash Cove Base
  - RB Rubber Base
  - SCF Seamless Cushioned Flooring

**DOORS**

Types:

Type	Qty	Size (mm)	Material	Finish	Side Lt.	Blinds	Protect.	Privacy Film	Function	Card Reader	Mag Lock	Auto Opener	Hold Open	Hinges	Accessory 1	Accessory 2	Accessory 3	Closer
C	1	1065 x 2135	Solid Core	FRL	<input type="checkbox"/>	<input type="checkbox"/>	2 High	<input checked="" type="checkbox"/>	Storeroom	<input checked="" type="checkbox"/>	<input type="checkbox"/>	<input type="checkbox"/>	<input checked="" type="checkbox"/>	Butt Hinge				Surface

Door Remarks:  Security Grille  Anti-barricade strategy

**MILLWORK AND SPECIALTY CASEWORK**

**UPPER UNITS** U1 U2 U3 U4 U5 U6 U7 U8

**LOWER UNITS** L10 L11 L12

**RECEPTION/TRANSACTION COUNTER / CARE TEAM STATION DESK** TC1 TC2

**UTILITY SINK AND COUNTER UNIT** UC1

**Storage Requirements:**

**FINISHES**

Full-height Cabinet:

Upper Millwork:

Countertop:

Lower Millwork:

Shelf:

Remarks:

Category	Min. Length (mm)	Motorized Adjustable Height	Standing Height	Specialty Casework
Category 0 - None		<input type="checkbox"/>	<input type="checkbox"/>	<input type="checkbox"/>
Category 1 - Low (1% - 4%)		<input type="checkbox"/>	<input type="checkbox"/>	<input type="checkbox"/>
Category 2 - Med (5% - 9%)		<input type="checkbox"/>	<input type="checkbox"/>	<input type="checkbox"/>
Category 3 - High (10% or Greater)		<input type="checkbox"/>	<input type="checkbox"/>	<input type="checkbox"/>

**MECHANICAL REQUIREMENTS**

<b>PLUMBING</b> (Quantity) Hygiene Sink: <input type="text" value="1"/> Lavatory: <input type="text"/> Kitchen Sink: <input type="text"/> Kitchen Sink: <input type="text"/> Utility / Process Sink: <input type="text"/> Scrub Sink: <input type="text"/> Floor Sink: <input type="text" value="1"/>							Other Fixtures: <input type="checkbox"/> Shower <input type="checkbox"/> Eyewash Station <input type="checkbox"/> Tub <input type="checkbox"/> Eyewash/Shower Station <input type="checkbox"/> Ice Maker <input type="checkbox"/> Emergency Shower <input type="checkbox"/> Water Closet <input checked="" type="checkbox"/> Floor Drain <input type="checkbox"/> Instantaneous Hot Water <input type="checkbox"/> Water Bottle Refill Station Other <input type="text"/>				<b>MED / NON-MED GASES</b> (Quantity) Oxygen: <input type="text"/> Medical Air: <input type="text"/> Medical Vacuum: <input type="text"/> Nitrous Oxide: <input type="text"/> CO2: <input type="text"/> AGSS: <input type="text"/> Nitrogen: <input type="text"/> Laboratory Air: <input type="text"/> Laboratory Vacuum: <input type="text"/> Utility Compressed Air: <input type="text"/>					
Plumbing Remarks: <input type="text" value="Wall mounted hose bib to be provided. Provide floor mounted mop basin."/>											Gas Remarks: <input type="text"/>					

**Appendix 1B Minimum Room Requirements**

Room Name:

Program Number(s):

1. C7.07	7.	13.	19.	25.	31.	37.	43.
2. F5.09	8.	14.	20.	26.	32.	38.	44.
3.	9.	15.	21.	27.	33.	39.	45.
4.	10.	16.	22.	28.	34.	40.	46.
5.	11.	17.	23.	29.	35.	41.	47.
6.	12.	18.	24.	30.	36.	42.	48.

**ARCHITECTURAL REQUIREMENTS**

<b>WALL AND CEILING</b> Wall Material: <input type="text" value="ARGB 1.2m AFF, GB above"/> Finish: <input type="text" value="PT"/> Ceiling Material: <input type="text" value="ACT"/> Finish: <input type="text" value="PF"/>		<b>WALL PROTECTION</b> Type: <input type="text" value="PVW"/> <input checked="" type="checkbox"/> Corner Guards <input type="checkbox"/> Hand Rails <input type="checkbox"/> Bed Bumper / Locator Height: <input type="text" value="1350 mm"/> <input type="checkbox"/> Crash Rails <input type="checkbox"/> Chair Rail		<b>GLAZING</b> <input type="checkbox"/> Interior Glazing		<b>FLOORING TYPES</b> Material: <input type="text" value="SDVF"/> Base: <input type="text" value="FCB"/>		<b>ROOM ACCESSORIES</b> <input type="checkbox"/> Coat Hooks <input checked="" type="checkbox"/> Ceiling Lift <input checked="" type="checkbox"/> Magnetic Whiteboard <input type="checkbox"/> Mirror <input type="checkbox"/> Infant Change Table <input type="checkbox"/> Privacy Curtain	
--	--	---	--	---	--	---	--	--	--

- LEGEND:**
- WALL AND CEILING LEGEND:**
- AC Architectural Ceiling
  - ACT Acoustic Ceiling Tile
  - ACT-C Cleanroom
  - ARGB Abuse-Resistant Gypsum Board
  - GB Gypsum Board
  - IRGB Impact-Resistant Gypsum Board
  - KLCT Kitchen Lay-in Ceiling Tile
  - MMRGB Moisture and Mould-Resistant Gypsum Board
  - SACT Security Acoustic Ceiling Tile
- WALL FINISHES LEGEND:**
- EWC Epoxy Wall Coating
  - HPC High Performance Coating
  - PT Paint
- CEILING FINISHES LEGEND:**
- ECC Epoxy Ceiling Coating
  - HPC High Performance Coating
  - PF Prefinished
  - PT Paint
- WALL PROTECTION LEGEND:**
- ESRP Extruded Semi-Rigid PVCu Panel
  - FRL Fibre Reinforced Laminate
  - FRP Fibreglass Reinforced Plastic
  - PVW Protective Vinyl Wallcovering
  - RHIS Rigid High Impact Sheet
  - WSSP Wetwall Solid Surface Panel
  - WVV Wetroom Vinyl Wallcovering
- FLOOR FINISHES LEGEND:**
- CFS Concrete Floor Sealer
  - EFC Epoxy Floor Coating
  - PFC Polyurethane Floor Coating
  - RAF Rubber Athletic Flooring
  - RSF Rubber Sheet Flooring
  - SCF Seamless Cushioned Flooring
  - SDRF Static-Dissipative Rubber Sheet Flooring
  - SDVF Static-Dissipative Vinyl Sheet Flooring
  - VSF Vinyl Sheet Flooring
  - WSVF Wetroom Safety Vinyl Sheet Flooring
- FLOOR BASE LEGEND:**
- FCB Flash Cove Base
  - RB Rubber Base
  - SCF Seamless Cushioned Flooring

**DOORS**

Types:

Note: for Type F doors, the door panels will be approximately 465/1065 unless otherwise required by the Authority

Door Remarks:  Security Grille  Anti-barricade strategy

Type	Qty	Size (mm)	Material	Finish	Side Lt.	Blinds	Protect.	Privacy Film	Function	Card Reader	Mag Lock	Auto Opener	Hold Open	Hinges	Accessory 1	Accessory 2	Accessory 3	Closer
F	1	1530 x 2135	Shielded	FRL	<input type="checkbox"/>	<input type="checkbox"/>	2 High	<input type="checkbox"/>	Storeroom	<input checked="" type="checkbox"/>	<input checked="" type="checkbox"/>	<input checked="" type="checkbox"/>	<input type="checkbox"/>	Butt Hinge	Astragal	Flush Bolt	Elec. Strike	Concealed

**MILLWORK AND SPECIALTY CASEWORK**

Storage Requirements:

**UPPER UNITS** (U1-U8)

**LOWER UNITS** (L1-L12)

**RECEPTION/TRANSACTION COUNTER / CARE TEAM STATION DESK** (TC1, TC2)

**UTILITY SINK AND COUNTER UNIT** (UC1)

**FINISHES**

Full-height Cabinet:	<input type="text" value="Plastic Laminate"/>
Upper Millwork:	<input type="text" value="Plastic Laminate"/>
Countertop:	<input type="text" value="Solid Surfacing"/>
Lower Millwork:	<input type="text" value="Plastic Laminate"/>
Shelf:	<input type="text"/>

Remarks:

**MECHANICAL REQUIREMENTS**

<b>PLUMBING</b> (Quantity)		Hand Hygiene Sink: <input type="text" value="1"/> Lavatory: <input type="text"/> Kitchen Sink: <input type="text"/> Seamless Kitchen Sink: <input type="text"/> Utility / Process Sink: <input type="text"/> Scrub Sink: <input type="text"/> Floor Sink: <input type="text"/>							Other Fixtures: <input type="checkbox"/> Shower <input type="checkbox"/> Tub <input type="checkbox"/> Ice Maker <input type="checkbox"/> Water Closet <input type="checkbox"/> Instantaneous Hot Water				<input type="checkbox"/> Eyewash Station <input type="checkbox"/> Eyewash/Shower Station <input type="checkbox"/> Emergency Shower <input type="checkbox"/> Flush Rim Sink <input type="checkbox"/> Floor Drain <input type="checkbox"/> Water Bottle Refill Station				<b>MED / NON-MED GASES</b> (Quantity)					
Plumbing Remarks:		Oxygen: <input type="text" value="2"/>		Medical Air: <input type="text" value="1"/>		Medical Vacuum: <input type="text" value="2"/>		Nitrous Oxide: <input type="text"/>		CO2: <input type="text"/>		AGSS: <input type="text"/>		Nitrogen: <input type="text"/>		Laboratory Air: <input type="text"/>		Laboratory Vacuum: <input type="text"/>		Utility Compressed Air: <input type="text"/>		
		Gas Remarks: <input type="text" value="Medical gasses to be on boom."/>																				

**Appendix 1B Minimum Room Requirements**

Room Name:

Program Number(s):

1. C7.05	7.	13.	19.	25.	31.	37.	43.
2. F4.07	8.	14.	20.	26.	32.	38.	44.
3.	9.	15.	21.	27.	33.	39.	45.
4.	10.	16.	22.	28.	34.	40.	46.
5.	11.	17.	23.	29.	35.	41.	47.
6.	12.	18.	24.	30.	36.	42.	48.

**ARCHITECTURAL REQUIREMENTS**

<b>WALL AND CEILING</b> Wall Material: <input type="text" value="ARGB 1.2m AFF, GB above"/> Finish: <input type="text" value="PT"/> Ceiling Material: <input type="text" value="ACT"/> Finish: <input type="text" value="PF"/>		<b>WALL PROTECTION</b> Type: <input type="text" value="PVW"/> <input checked="" type="checkbox"/> Corner Guards <input type="checkbox"/> Hand Rails <input type="checkbox"/> Bed Bumper / Locator Height: <input type="text" value="1350 mm"/> <input type="checkbox"/> Crash Rails <input type="checkbox"/> Chair Rail		<b>GLAZING</b> <input type="checkbox"/> Interior Glazing		<b>FLOORING TYPES</b> Material: <input type="text" value="SDVF"/> Base: <input type="text" value="FCB"/>		<b>ROOM ACCESSORIES</b> <input type="checkbox"/> Coat Hooks <input checked="" type="checkbox"/> Ceiling Lift <input checked="" type="checkbox"/> Magnetic Whiteboard <input type="checkbox"/> Mirror <input type="checkbox"/> Infant Change Table <input type="checkbox"/> Privacy Curtain	
--	--	---	--	---	--	---	--	--	--

- LEGEND:**
- WALL AND CEILING LEGEND:**
- AC Architectural Ceiling
  - ACT Acoustic Ceiling Tile
  - ACT-C Cleanroom
  - ARGB Abuse-Resistant Gypsum Board
  - GB Gypsum Board
  - IRGB Impact-Resistant Gypsum Board
  - KLCT Kitchen Lay-in Ceiling Tile
  - MMRGB Moisture and Mould-Resistant Gypsum Board
  - SACT Security Acoustic Ceiling Tile
- WALL FINISHES LEGEND:**
- EWC Epoxy Wall Coating
  - HPC High Performance Coating
  - PT Paint
- CEILING FINISHES LEGEND:**
- ECC Epoxy Ceiling Coating
  - HPC High Performance Coating
  - PF Prefinished
  - PT Paint
- WALL PROTECTION LEGEND:**
- ESRP Extruded Semi-Rigid PVCu Panel
  - FRL Fibre Reinforced Laminate
  - FRP Fibreglass Reinforced Plastic
  - PVW Protective Vinyl Wallcovering
  - RHIS Rigid High Impact Sheet
  - WSSP Wetwall Solid Surface Panel
  - WVV Wetroom Vinyl Wallcovering
- FLOOR FINISHES LEGEND:**
- CFS Concrete Floor Sealer
  - EFC Epoxy Floor Coating
  - PFC Polyurethane Floor Coating
  - RAF Rubber Athletic Flooring
  - RSF Rubber Sheet Flooring
  - SCF Seamless Cushioned Flooring
  - SDRF Static-Dissipative Rubber Sheet Flooring
  - SDVF Static-Dissipative Vinyl Sheet Flooring
  - VSF Vinyl Sheet Flooring
  - WSVF Wetroom Safety Vinyl Sheet Flooring
- FLOOR BASE LEGEND:**
- FCB Flash Cove Base
  - RB Rubber Base
  - SCF Seamless Cushioned Flooring

**DOORS**

Types:

Note: for Type F doors, the door panels will be approximately 465/1065 unless otherwise required by the Authority

Type	Qty	Size (mm)	Material	Finish	Side Lt.	Blinds	Protect.	Privacy Film	Function	Card Reader	Mag Lock	Auto Opener	Hold Open	Hinges	Accessory 1	Accessory 2	Accessory 3	Closer
F	1	1530 x 2135	Solid Core	FRL	<input type="checkbox"/>	<input type="checkbox"/>	2 High	<input type="checkbox"/>	Storeroom	<input checked="" type="checkbox"/>	<input type="checkbox"/>	<input type="checkbox"/>	<input checked="" type="checkbox"/>	Butt Hinge	Astragal	Flush Bolt		Concealed

**Door Remarks:**

Security Grille  
 Anti-barricade strategy

**MILLWORK AND SPECIALTY CASEWORK**

Storage Requirements:

**UPPER UNITS:** U1, U2, U3, U4, U5, U6, U7, U8

**LOWER UNITS:** L1, L2, L3, L4, L5, L6, L7, L8, L9, L10, L11, L12

**RECEPTION/TRANSACTION COUNTER / CARE TEAM STATION DESK:** TC1, TC2

**UTILITY SINK AND COUNTER UNIT:** UC1

**SHELF:** S1

**FULL-HEIGHT CABINETS:** C1, C2, C3, C4, C5

**Legend:**

Category	Min. Length (mm)	Motorized Adjustable Height	Standing Height	Specialty Casework
2	2100	<input type="checkbox"/>	<input checked="" type="checkbox"/>	<input type="checkbox"/>

**FINISHES**

Full-height Cabinet:

Upper Millwork:

Countertop:

Lower Millwork:

Shelf:

**Remarks:**

**MECHANICAL REQUIREMENTS**

**PLUMBING**

Hand Hygiene Sink:	Lavatory:	Kitchen Sink:	Seamless Kitchen Sink:	Utility / Process Sink:	Scrub Sink:	Floor Sink:
1						

Plumbing Remarks:

**Other Fixtures:**

- Shower
- Tub
- Ice Maker
- Water Closet
- Instantaneous Hot Water
- Ewewash Station
- Eyewash/Shower Station
- Emergency Shower
- Flush Rim Sink
- Floor Drain
- Water Bottle Refill Station

Other:

**MED / NON-MED GASES**

Oxygen:	Medical Air:	Medical Vacuum:	Nitrous Oxide:	CO2:	AGSS:	Nitrogen:	Laboratory Air:	Laboratory Vacuum:	Utility Compressed Air:
1	1	1							

Gas Remarks:



**Appendix 1B Minimum Room Requirements**

Room Name:

Program Number(s):

1. D7.09	7.	13.	19.	25.	31.	37.	43.
2. P4.08	8.	14.	20.	26.	32.	38.	44.
3. W4.18	9.	15.	21.	27.	33.	39.	45.
4. Y1.06	10.	16.	22.	28.	34.	40.	46.
5.	11.	17.	23.	29.	35.	41.	47.
6.	12.	18.	24.	30.	36.	42.	48.

**ARCHITECTURAL REQUIREMENTS**

<b>WALL AND CEILING</b> Wall Material: <input type="text" value="MMRGB"/> Finish: <input type="text" value="EWC"/> Ceiling Material: <input type="text" value="MMRGB"/> Finish: <input type="text" value="ECC"/>	<b>WALL PROTECTION</b> Type: <input type="text" value="WSSP"/> <input checked="" type="checkbox"/> Corner Guards <input type="checkbox"/> Hand Rails <input type="checkbox"/> Bed Bumper / Locator Height: <input type="text" value="2185 mm"/> <input type="checkbox"/> Crash Rails <input type="checkbox"/> Chair Rail	<b>GLAZING</b> <input type="checkbox"/> Interior Glazing	<b>FLOORING TYPES</b> Material: <input type="text" value="WSVF"/> Base: <input type="text" value="FCB"/>	<b>ROOM ACCESSORIES</b> <input checked="" type="checkbox"/> Coat Hooks <input type="checkbox"/> Ceiling Lift <input checked="" type="checkbox"/> Magnetic Whiteboard <input checked="" type="checkbox"/> Mirror <input type="checkbox"/> Infant Change Table <input type="checkbox"/> Privacy Curtain
--	--	---	---	---

- LEGEND:**
- WALL AND CEILING LEGEND:**
- AC Architectural Ceiling
  - ACT Acoustic Ceiling Tile
  - ACT-C Cleanroom
  - ARGB Abuse-Resistant Gypsum Board
  - GB Gypsum Board
  - IRGB Impact-Resistant Gypsum Board
  - KLCT Kitchen Lay-in Ceiling Tile
  - MMRGB Moisture and Mould-Resistant Gypsum Board
  - SACT Security Acoustic Ceiling Tile
- WALL FINISHES LEGEND:**
- EWC Epoxy Wall Coating
  - HPC High Performance Coating
  - PT Paint
- CEILING FINISHES LEGEND:**
- ECC Epoxy Ceiling Coating
  - HPC High Performance Coating
  - PF Prefinished
  - PT Paint
- WALL PROTECTION LEGEND:**
- ESRP Extruded Semi-Rigid PVCu Panel
  - FRL Fibre Reinforced Laminate
  - FRP Fibreglass Reinforced Plastic
  - PVV Protective Vinyl Wallcovering
  - RHIS Rigid High Impact Sheet
  - WSSP Wetwall Solid Surface Panel
  - WWW Wetroom Vinyl Wallcovering
- FLOOR FINISHES LEGEND:**
- CFS Concrete Floor Sealer
  - EFC Epoxy Floor Coating
  - PFC Polyurethane Floor Coating
  - RAF Rubber Athletic Flooring
  - RSF Rubber Sheet Flooring
  - SCF Seamless Cushioned Flooring
  - SDRF Static-Dissipative Rubber Sheet Flooring
  - SDVF Static-Dissipative Vinyl Sheet Flooring
  - VSF Vinyl Sheet Flooring
  - WSVF Wetroom Safety Vinyl Sheet Flooring
- FLOOR BASE LEGEND:**
- FCB Flash Cove Base
  - RB Rubber Base
  - SCF Seamless Cushioned Flooring

**DOORS**

Types:

Type	Qty	Size (mm)	Material	Finish	Side Lt.	Blinds	Protect.	Privacy Film	Function	Card Reader	Mag Lock	Auto Opener	Hold Open	Hinges	Accessory 1	Accessory 2	Accessory 3	Closer
A	1	1065 x 2135	Solid Core	FRL	<input type="checkbox"/>	<input type="checkbox"/>	1 Low	<input type="checkbox"/>	Storeroom	<input checked="" type="checkbox"/>	<input type="checkbox"/>	<input type="checkbox"/>	<input checked="" type="checkbox"/>	Butt Hinge				Surface

Door Remarks:  Security Grille  Anti-barricade strategy

**MILLWORK AND SPECIALTY CASEWORK**

Storage Requirements: D7.09 - (78) half lockers and (12) stacked shoe cubbies, each with a stack of (6) shoe cubbies  
 P4.08 - (20) half lockers and shoe rack  
 W4.18 - (10) full height lockers, (10) half lockers  
 Y1.06 - (254) half lockers  
 Refer to Schedule 1, Section 5.7.14 for shoe storage information.

**FINISHES**

Full-height Cabinet:   
 Upper Millwork:   
 Countertop:   
 Lower Millwork:   
 Shelf:

Remarks: Minimum one (1) change cubicle, shower stall, toilet stall, and vanity with lavatory sink will be designed to be accessible for Persons with Disabilities in each Locker Room.  
 P4.08 will not require a change cubicle, shower stall and toilet stall designed to be accessible for Persons with Disabilities.  
 For washroom vanity requirements, refer to Schedule 1, Section 6.6.2 - Section 06 40 00 - Architectural Woodwork  
 D7.09 - Provide (4) change cubicles  
 P4.08 - Provide (2) change cubicles  
 W4.18 - Provide (1) change cubicle  
 Y1.06 - Provide (4) change cubicles

**MECHANICAL REQUIREMENTS**

<b>PLUMBING</b> (Quantity) Hand Hygiene Sink: <input type="text" value="1"/> Lavatory: <input type="text"/> Kitchen Sink: <input type="text"/> Kitchen Sink: <input type="text"/> Process Sink: <input type="text"/> Scrub Sink: <input type="text"/> Floor Sink: <input type="text"/> Plumbing Remarks: D7.09 - Provide (2) toilet stalls, (2) shower stalls, and (2) vanities each with sink and mirror P4.08 - Provide (1) toilet stall, (1) shower stall, and (1) vanity with sink and mirror W4.18 - Provide (1) toilet stall, (1) shower stall and (1) vanity with sink and mirror Y1.06 - Provide (6) toilet stalls, (4) shower stalls, and (4) vanities with sink and mirror	Other Fixtures: <input checked="" type="checkbox"/> Shower <input type="checkbox"/> Tub <input type="checkbox"/> Ice Maker <input checked="" type="checkbox"/> Water Closet <input type="checkbox"/> Instantaneous Hot Water <input type="checkbox"/> Eyewash Station <input type="checkbox"/> Eyewash/Shower Station <input type="checkbox"/> Emergency Shower <input type="checkbox"/> Flush Rim Sink <input checked="" type="checkbox"/> Floor Drain <input type="checkbox"/> Water Bottle Refill Station Other: <input type="text"/>	<b>MED / NON-MED GASES</b> (Quantity) Oxygen: <input type="text"/> Medical Air: <input type="text"/> Medical Vacuum: <input type="text"/> Nitrous Oxide: <input type="text"/> CO2: <input type="text"/> AGSS: <input type="text"/> Nitrogen: <input type="text"/> Laboratory Air: <input type="text"/> Laboratory Vacuum: <input type="text"/> Utility Compressed Air: <input type="text"/> Gas Remarks: <input type="text"/>
--	---	---

**Appendix 1B Minimum Room Requirements**

Room Name:

Program Number(s):

1. D7.05	7.	13.	19.	25.	31.	37.	43.
2. P4.06	8.	14.	20.	26.	32.	38.	44.
3. W4.14	9.	15.	21.	27.	33.	39.	45.
4. Y1.02	10.	16.	22.	28.	34.	40.	46.
5.	11.	17.	23.	29.	35.	41.	47.
6.	12.	18.	24.	30.	36.	42.	48.

**ARCHITECTURAL REQUIREMENTS**

<b>WALL AND CEILING</b> Wall Material: <input type="text" value="MMRGB"/> Finish: <input type="text" value="EWC"/> Ceiling Material: <input type="text" value="MMRGB"/> Finish: <input type="text" value="ECC"/>	<b>WALL PROTECTION</b> Type: <input type="text" value="WSSP"/> <input checked="" type="checkbox"/> Corner Guards <input type="checkbox"/> Hand Rails <input type="checkbox"/> Bed Bumper / Locator Height: <input type="text" value="2185 mm"/> <input type="checkbox"/> Crash Rails <input type="checkbox"/> Chair Rail	<b>GLAZING</b> <input type="checkbox"/> Interior Glazing	<b>FLOORING TYPES</b> Material: <input type="text" value="WSVF"/> Base: <input type="text" value="FCB"/>	<b>ROOM ACCESSORIES</b> <input checked="" type="checkbox"/> Coat Hooks <input type="checkbox"/> Ceiling Lift <input checked="" type="checkbox"/> Magnetic Whiteboard <input checked="" type="checkbox"/> Mirror <input type="checkbox"/> Infant Change Table <input type="checkbox"/> Privacy Curtain
--	--	---	---	---

- LEGEND:**
- WALL AND CEILING LEGEND:**
- AC Architectural Ceiling
  - ACT Acoustic Ceiling Tile
  - ACT-C Cleanroom
  - ARGB Abuse-Resistant Gypsum Board
  - GB Gypsum Board
  - IRGB Impact-Resistant Gypsum Board
  - KLCT Kitchen Lay-in Ceiling Tile
  - MMRGB Moisture and Mould-Resistant Gypsum Board
  - SACT Security Acoustic Ceiling Tile
- WALL FINISHES LEGEND:**
- EWC Epoxy Wall Coating
  - HPC High Performance Coating
  - PT Paint
- CEILING FINISHES LEGEND:**
- ECC Epoxy Ceiling Coating
  - HPC High Performance Coating
  - PF Prefinished
  - PT Paint
- WALL PROTECTION LEGEND:**
- ESRP Extruded Semi-Rigid PVCu Panel
  - FRL Fibre Reinforced Laminate
  - FRP Fibreglass Reinforced Plastic
  - PVV Protective Vinyl Wallcovering
  - RHIS Rigid High Impact Sheet
  - WSSP Wetwall Solid Surface Panel
  - WWW Wetroom Vinyl Wallcovering
- FLOOR FINISHES LEGEND:**
- CFS Concrete Floor Sealer
  - EFC Epoxy Floor Coating
  - PFC Polyurethane Floor Coating
  - RAF Rubber Athletic Flooring
  - RSF Rubber Sheet Flooring
  - SCF Seamless Cushioned Flooring
  - SDRF Static-Dissipative Rubber Sheet Flooring
  - SDVF Static-Dissipative Vinyl Sheet Flooring
  - VSF Vinyl Sheet Flooring
  - WSVF Wetroom Safety Vinyl Sheet Flooring
- FLOOR BASE LEGEND:**
- FCB Flash Cove Base
  - RB Rubber Base
  - SCF Seamless Cushioned Flooring

**DOORS**

Types:

Type	Qty	Size (mm)	Material	Finish	Side Lt.	Blinds	Protect.	Privacy Film	Function	Card Reader	Mag Lock	Auto Opener	Hold Open	Hinges	Accessory 1	Accessory 2	Accessory 3	Closer
A	1	1065 x 2135	Solid Core	FRL	<input type="checkbox"/>	<input type="checkbox"/>	1 Low	<input type="checkbox"/>	Storeroom	<input checked="" type="checkbox"/>	<input type="checkbox"/>	<input type="checkbox"/>	<input checked="" type="checkbox"/>	Butt Hinge				Surface

Door Remarks:  Security Grille  Anti-barricade strategy

**MILLWORK AND SPECIALTY CASEWORK**

Storage Requirements: D7.05 - (48) half lockers and (8) stacked shoe cubbies, each with a stack of (6) shoe cubbies  
 P4.06 - (20) half lockers and shoe rack  
 W4.14 - (20) full height lockers, (10) half lockers  
 Y1.02 - (166) half locker  
 Refer to Schedule 1, Section 5.7.14 for shoe storage information.

**FINISHES**

Full-height Cabinet:   
 Upper Millwork:   
 Countertop:   
 Lower Millwork:   
 Shelf:

Remarks: Minimum one (1) change cubicle, shower stall, toilet stall, and vanity with lavatory sink will be designed to be accessible for Persons with Disabilities in each Locker Room.  
 P4.06 will not require a change cubicle, shower stall and toilet stall designed to be accessible for Persons with Disabilities.  
 For washroom vanity requirements, refer to Schedule 1, Section 6.6.2 - Section 06 40 00 - Architectural Woodwork  
 D7.05 - Provide (2) change cubicles  
 P4.06 - Provide (2) change cubicles  
 W4.14 - Provide (1) change cubicle  
 Y1.02 - Provide (4) change cubicles

**MECHANICAL REQUIREMENTS**

<b>PLUMBING</b> (Quantity) Hand Hygiene Sink: <input type="text" value="1"/> Lavatory: <input type="text"/> Kitchen Sink: <input type="text"/> Seamless Kitchen Sink: <input type="text"/> Utility / Process Sink: <input type="text"/> Scrub Sink: <input type="text"/> Floor Sink: <input type="text"/> Plumbing Remarks: D7.05 - Provide (2) toilet stalls, (2) shower stalls, and (1) vanity with sink and mirror P4.06 - Provide (1) toilet stall, (1) shower stall, and (1) vanity with sink and mirror W4.14 - Provide (1) toilet stall, (1) shower stall, and (1) vanity with sink and mirror Y1.02 - Provide (6) toilet stalls, (4) shower stalls, and (2) vanities with sink and mirror	Other Fixtures: <input checked="" type="checkbox"/> Shower <input type="checkbox"/> Eyewash Station <input type="checkbox"/> Tub <input type="checkbox"/> Eyewash/Shower Station <input type="checkbox"/> Ice Maker <input type="checkbox"/> Emergency Shower <input type="checkbox"/> Water Closet <input checked="" type="checkbox"/> Flush Rim Sink <input type="checkbox"/> Instantaneous Hot Water <input type="checkbox"/> Floor Drain <input type="checkbox"/> Water Bottle Refill Station Other: <input type="text"/>	<b>MED / NON-MED GASES</b> (Quantity) Oxygen: <input type="text"/> Medical Air: <input type="text"/> Medical Vacuum: <input type="text"/> Nitrous Oxide: <input type="text"/> CO2: <input type="text"/> AGSS: <input type="text"/> Nitrogen: <input type="text"/> Laboratory Air: <input type="text"/> Laboratory Vacuum: <input type="text"/> Utility Compressed Air: <input type="text"/> Gas Remarks: <input type="text"/>
---	--	---

**Appendix 1B Minimum Room Requirements**

Room Name:

Program Number(s):

1. J5.01	7.	13.	19.	25.	31.	37.	43.
2. M1.01	8.	14.	20.	26.	32.	38.	44.
3.	9.	15.	21.	27.	33.	39.	45.
4.	10.	16.	22.	28.	34.	40.	46.
5.	11.	17.	23.	29.	35.	41.	47.
6.	12.	18.	24.	30.	36.	42.	48.

**ARCHITECTURAL REQUIREMENTS**

<b>WALL AND CEILING</b> Wall Material: <input type="text" value="MMRGB"/> Finish: <input type="text" value="PT"/> Ceiling Material: <input type="text" value="MMRGB"/> Finish: <input type="text" value="ECC"/>	<b>WALL PROTECTION</b> Type: <input type="text" value="WSSP"/> <input checked="" type="checkbox"/> Corner Guards <input type="checkbox"/> Hand Rails <input type="checkbox"/> Bed Bumper / Locator Height: <input type="text" value="2185 mm"/> <input type="checkbox"/> Crash Rails <input type="checkbox"/> Chair Rail	<b>GLAZING</b> <input type="checkbox"/> Interior Glazing	<b>FLOORING TYPES</b> Material: <input type="text" value="WSVF"/> Base: <input type="text" value="FCB"/>	<b>ROOM ACCESSORIES</b> <input checked="" type="checkbox"/> Coat Hooks <input type="checkbox"/> Ceiling Lift <input checked="" type="checkbox"/> Magnetic Whiteboard <input checked="" type="checkbox"/> Mirror <input type="checkbox"/> Infant Change Table <input type="checkbox"/> Privacy Curtain
---	--	---	---	---

- LEGEND:**
- WALL AND CEILING LEGEND:**
- AC Architectural Ceiling
  - ACT Acoustic Ceiling Tile
  - ACT-C Cleanroom
  - ARGB Abuse-Resistant Gypsum Board
  - GB Gypsum Board
  - IRGB Impact-Resistant Gypsum Board
  - KLCT Kitchen Lay-in Ceiling Tile
  - MMRGB Moisture and Mould-Resistant Gypsum Board
  - SACT Security Acoustic Ceiling Tile
- WALL FINISHES LEGEND:**
- EWC Epoxy Wall Coating
  - HPC High Performance Coating
  - PT Paint
- CEILING FINISHES LEGEND:**
- ECC Epoxy Ceiling Coating
  - HPC High Performance Coating
  - PF Prefinished
  - PT Paint
- WALL PROTECTION LEGEND:**
- ESRP Extruded Semi-Rigid PVCu Panel
  - FRL Fibre Reinforced Laminate
  - FRP Fibreglass Reinforced Plastic
  - PVV Protective Vinyl Wallcovering
  - RHIS Rigid High Impact Sheet
  - WSSP Wetwall Solid Surface Panel
  - WWW Wetroom Vinyl Wallcovering
- FLOOR FINISHES LEGEND:**
- CFS Concrete Floor Sealer
  - EFC Epoxy Floor Coating
  - PFC Polyurethane Floor Coating
  - RAF Rubber Athletic Flooring
  - RSF Rubber Sheet Flooring
  - SCF Seamless Cushioned Flooring
  - SDRF Static-Dissipative Rubber Sheet Flooring
  - SDVF Static-Dissipative Vinyl Sheet Flooring
  - VSF Vinyl Sheet Flooring
  - WSVF Wetroom Safety Vinyl Sheet Flooring
- FLOOR BASE LEGEND:**
- FCB Flash Cove Base
  - RB Rubber Base
  - SCF Seamless Cushioned Flooring

**DOORS**

Types:

Type	Qty	Size (mm)	Material	Finish	Side Lt.	Blinds	Protect.	Privacy Film	Function	Card Reader	Mag Lock	Auto Opener	Hold Open	Hinges	Accessory 1	Accessory 2	Accessory 3	Closer
A	1	1065 x 2135	Solid Core	FRL	<input type="checkbox"/>	<input type="checkbox"/>	1 Low	<input type="checkbox"/>	Storeroom	<input checked="" type="checkbox"/>	<input type="checkbox"/>	<input type="checkbox"/>	<input checked="" type="checkbox"/>	Butt Hinge				Surface

Door Remarks:  Security Grille  Anti-barricade strategy

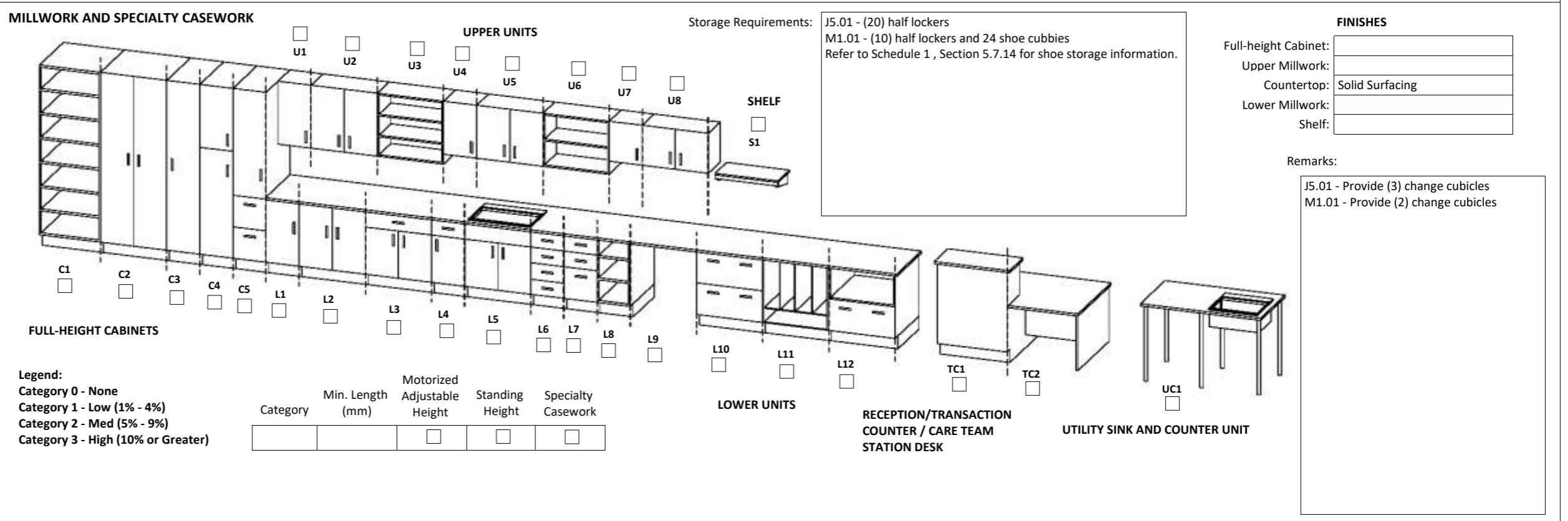

**MECHANICAL REQUIREMENTS**

<b>PLUMBING</b> (Quantity) Hand Hygiene Sink: <input type="text"/> Lavatory: <input type="text"/> Kitchen Sink: <input type="text"/> Seamless Kitchen Sink: <input type="text"/> Utility / Process Sink: <input type="text"/> Scrub Sink: <input type="text"/> Floor Sink: <input type="text"/> Plumbing Remarks: <input type="text"/>	Other Fixtures: <input type="checkbox"/> Shower <input type="checkbox"/> Eyewash Station <input type="checkbox"/> Tub <input type="checkbox"/> Eyewash/Shower Station <input type="checkbox"/> Ice Maker <input type="checkbox"/> Emergency Shower <input type="checkbox"/> Water Closet <input type="checkbox"/> Flush Rim Sink <input type="checkbox"/> Instantaneous Hot Water <input type="checkbox"/> Floor Drain <input type="checkbox"/> <input type="checkbox"/> Water Bottle Refill Station Other: <input type="text"/>	<b>MED / NON-MED GASES</b> (Quantity) Oxygen: <input type="text"/> Medical Air: <input type="text"/> Medical Vacuum: <input type="text"/> Nitrous Oxide: <input type="text"/> CO2: <input type="text"/> AGSS: <input type="text"/> Nitrogen: <input type="text"/> Laboratory Air: <input type="text"/> Laboratory Vacuum: <input type="text"/> Utility Compressed Air: <input type="text"/> Gas Remarks: <input type="text"/>
---	---	--



**Appendix 1B Minimum Room Requirements**

Room Name:

Program Number(s):

1. B4.09	7. U7.01	13.	19.	25.	31.	37.	43.
2. C8.06	8. W4.13	14.	20.	26.	32.	38.	44.
3. D7.15	9. Y1.16	15.	21.	27.	33.	39.	45.
4. E7.06	10. Y5.01	16.	22.	28.	34.	40.	46.
5. F8.10	11.	17.	23.	29.	35.	41.	47.
6. R4.05	12.	18.	24.	30.	36.	42.	48.

**ARCHITECTURAL REQUIREMENTS**

<b>WALL AND CEILING</b> Wall Material: <input type="text" value="GB"/> Finish: <input type="text" value="PT"/> Ceiling Material: <input type="text" value="ACT"/> Finish: <input type="text" value="PF"/>		<b>WALL PROTECTION</b> Type: <input type="text" value="PVW"/> <input checked="" type="checkbox"/> Corner Guards <input type="checkbox"/> Hand Rails <input type="checkbox"/> Bed Bumper / Locator Height: <input type="text" value="1350 mm"/> <input type="checkbox"/> Crash Rails <input checked="" type="checkbox"/> Chair Rail		<b>GLAZING</b> <input checked="" type="checkbox"/> Interior Glazing		<b>FLOORING TYPES</b> Material: <input type="text" value="VSF"/> Base: <input type="text" value="FCB"/>		<b>ROOM ACCESSORIES</b> <input checked="" type="checkbox"/> Coat Hooks <input type="checkbox"/> Ceiling Lift <input checked="" type="checkbox"/> Magnetic Whiteboard <input type="checkbox"/> Mirror <input type="checkbox"/> Infant Change Table <input type="checkbox"/> Privacy Curtain	
---	--	--	--	--	--	--	--	--	--

- LEGEND:**
- WALL AND CEILING LEGEND:**
- AC Architectural Ceiling
  - ACT Acoustic Ceiling Tile
  - ACT-C Cleanroom
  - ARGB Abuse-Resistant Gypsum Board
  - GB Gypsum Board
  - IRGB Impact-Resistant Gypsum Board
  - KLCT Kitchen Lay-in Ceiling Tile
  - MMRGB Moisture and Mould-Resistant Gypsum Board
  - SACT Security Acoustic Ceiling Tile
- WALL FINISHES LEGEND:**
- EWC Epoxy Wall Coating
  - HPC High Performance Coating
  - PT Paint
- CEILING FINISHES LEGEND:**
- ECC Epoxy Ceiling Coating
  - HPC High Performance Coating
  - PF Prefinished
  - PT Paint
- WALL PROTECTION LEGEND:**
- ESRP Extruded Semi-Rigid PVCu Panel
  - FRL Fibre Reinforced Laminate
  - FRP Fibreglass Reinforced Plastic
  - PVW Protective Vinyl Wallcovering
  - RHIS Rigid High Impact Sheet
  - WSSP Wetwall Solid Surface Panel
  - WVV Wetroom Vinyl Wallcovering
- FLOOR FINISHES LEGEND:**
- CFS Concrete Floor Sealer
  - EFC Epoxy Floor Coating
  - PFC Polyurethane Floor Coating
  - RAF Rubber Athletic Flooring
  - RSF Rubber Sheet Flooring
  - SCF Seamless Cushioned Flooring
  - SDRF Static-Dissipative Rubber Sheet Flooring
  - SDVF Static-Dissipative Vinyl Sheet Flooring
  - VSF Vinyl Sheet Flooring
  - WSVF Wetroom Safety Vinyl Sheet Flooring
- FLOOR BASE LEGEND:**
- FCB Flash Cove Base
  - RB Rubber Base
  - SCF Seamless Cushioned Flooring

**DOORS**

Types:

Type	Qty	Size (mm)	Material	Finish	Side Lt.	Blinds	Protect.	Privacy Film	Function	Card Reader	Mag Lock	Auto Opener	Hold Open	Hinges	Accessory 1	Accessory 2	Accessory 3	Closer
C	1	915 x 2135	Solid Core	FRL			1 Low		Storeroom	<input checked="" type="checkbox"/>				Butt Hinge				Surface

Door Remarks:  Security Grille  Anti-barricade strategy

**MILLWORK AND SPECIALTY CASEWORK**

Storage Requirements: B4.09 - (20) purse lockers, E7.06 - (40) purse lockers, F8.10 - (100) purse lockers, P4.04 - (12) purse lockers, R4.05 - (20) purse lockers

**UPPER UNITS** (U1-U8)

**LOWER UNITS** (L1-L12)

**RECEPTION/TRANSACTION COUNTER / CARE TEAM STATION DESK** (TC1, TC2)

**UTILITY SINK AND COUNTER UNIT** (UC1)

**FINISHES**

Full-height Cabinet:

Upper Millwork:

Countertop:

Lower Millwork:

Shelf:

Remarks: Refer to Appendix 1A, Section 3.1 Recurring Rooms for nourishment station requirements.

**MECHANICAL REQUIREMENTS**

<b>PLUMBING</b> (Quantity) Hygiene Sink: <input type="text" value="1"/> Lavatory: <input type="text"/> Kitchen Sink: <input type="text" value="1"/> Seamless Kitchen Sink: <input type="text"/> Utility / Process Sink: <input type="text"/> Scrub Sink: <input type="text"/> Floor Sink: <input type="text"/>							Other Fixtures: <input type="checkbox"/> Shower <input type="checkbox"/> Tub <input type="checkbox"/> Ice Maker <input type="checkbox"/> Water Closet <input type="checkbox"/> Instantaneous Hot Water				<input type="checkbox"/> Eyewash Station <input type="checkbox"/> Eyewash/Shower Station <input type="checkbox"/> Emergency Shower <input type="checkbox"/> Flush Rim Sink <input type="checkbox"/> Floor Drain <input checked="" type="checkbox"/> Water Bottle Refill Station				<b>MED / NON-MED GASES</b> (Quantity) Oxygen: <input type="text"/> Medical Air: <input type="text"/> Medical Vacuum: <input type="text"/> Nitrous Oxide: <input type="text"/> CO2: <input type="text"/> AGSS: <input type="text"/> Nitrogen: <input type="text"/> Laboratory Air: <input type="text"/> Laboratory Vacuum: <input type="text"/> Utility Compressed Air: <input type="text"/>				
Plumbing Remarks: <input type="text"/>							Gas Remarks: <input type="text"/>				Gas Remarks: <input type="text"/>								

**Appendix 1B Minimum Room Requirements**

Room Name:

Program Number(s):

1. A4.01	7. D6.13	13.	19.	25.	31.	37.	43.
2. B1.12	8. G1.16	14.	20.	26.	32.	38.	44.
3. B2.16	9.	15.	21.	27.	33.	39.	45.
4. B3.15	10.	16.	22.	28.	34.	40.	46.
5. C3.25	11.	17.	23.	29.	35.	41.	47.
6. C4.21	12.	18.	24.	30.	36.	42.	48.

**ARCHITECTURAL REQUIREMENTS**

<b>WALL AND CEILING</b> Wall Material: <input type="text" value="ARGB 1.2m AFF, GB above"/> Finish: <input type="text" value="PT"/> Ceiling Material: <input type="text" value="ACT"/> Finish: <input type="text" value="PF"/>		<b>WALL PROTECTION</b> Type: <input type="text" value="FRP"/> <input checked="" type="checkbox"/> Corner Guards <input type="checkbox"/> Hand Rails <input type="checkbox"/> Bed Bumper / Locator Height: <input type="text" value="1350 mm"/> <input type="checkbox"/> Crash Rails <input type="checkbox"/> Chair Rail		<b>GLAZING</b> <input checked="" type="checkbox"/> Interior Glazing		<b>FLOORING TYPES</b> Material: <input type="text" value="VSF"/> Base: <input type="text" value="FCB"/>		<b>ROOM ACCESSORIES</b> <input type="checkbox"/> Coat Hooks <input type="checkbox"/> Ceiling Lift <input checked="" type="checkbox"/> Magnetic Whiteboard <input type="checkbox"/> Mirror <input type="checkbox"/> Infant Change Table <input type="checkbox"/> Privacy Curtain	
--	--	---	--	--	--	--	--	---	--

- LEGEND:**
- WALL AND CEILING LEGEND:**
- AC Architectural Ceiling
  - ACT Acoustic Ceiling Tile
  - ACT-C Cleanroom
  - ARGB Abuse-Resistant Gypsum Board
  - GB Gypsum Board
  - IRGB Impact-Resistant Gypsum Board
  - KLCT Kitchen Lay-in Ceiling Tile
  - MMRGB Moisture and Mould-Resistant Gypsum Board
  - SACT Security Acoustic Ceiling Tile
- WALL FINISHES LEGEND:**
- EWC Epoxy Wall Coating
  - HPC High Performance Coating
  - PT Paint
- CEILING FINISHES LEGEND:**
- ECC Epoxy Ceiling Coating
  - HPC High Performance Coating
  - PF Prefinished
  - PT Paint
- WALL PROTECTION LEGEND:**
- ESRP Extruded Semi-Rigid PVCu Panel
  - FRL Fibre Reinforced Laminata
  - FRP Fibreglass Reinforced Plastic
  - PVV Protective Vinyl Wallcovering
  - RHIS Rigid High Impact Sheet
  - WSSP Wetwall Solid Surface Panel
  - WVV Wetroom Vinyl Wallcovering
- FLOOR FINISHES LEGEND:**
- CFS Concrete Floor Sealer
  - EFC Epoxy Floor Coating
  - PFC Polyurethane Floor Coating
  - RAF Rubber Athletic Flooring
  - RSF Rubber Sheet Flooring
  - SCF Seamless Cushioned Flooring
  - SDRF Static-Dissipative Rubber Sheet Flooring
  - SDVF Static-Dissipative Vinyl Sheet Flooring
  - VSF Vinyl Sheet Flooring
  - WSVF Wetroom Safety Vinyl Sheet Flooring
- FLOOR BASE LEGEND:**
- FCB Flash Cove Base
  - RB Rubber Base
  - SCF Seamless Cushioned Flooring

**DOORS**

Types:

Type	Qty	Size (mm)	Material	Finish	Side Lt.	Blinds	Protect.	Film	Function	Card Reader	Mag Lock	Auto Opener	Hold Open	Hinges	Accessory 1	Accessory 2	Accessory 3	Closer
B	1	1065 x 2135	Solid Core	FRL	<input type="checkbox"/>	<input type="checkbox"/>	2 High	<input type="checkbox"/>	Storeroom	<input checked="" type="checkbox"/>	<input type="checkbox"/>	<input checked="" type="checkbox"/>	<input type="checkbox"/>	Butt Hinge	Elec. Strike			Surface

Door Remarks:  Security Grille  Anti-barricade strategy

**MILLWORK AND SPECIALTY CASEWORK**

**UPPER UNITS** (U1-U8) **LOWER UNITS** (L1-L9)

**RECEPTION/TRANSACTION COUNTER / CARE TEAM STATION DESK** (TC1, TC2)

**UTILITY SINK AND COUNTER UNIT** (UC1)

**Storage Requirements:**  SHELF (S1)

Category	Min. Length (mm)	Motorized Adjustable Height	Standing Height	Specialty Casework
3	3900	<input checked="" type="checkbox"/>	<input checked="" type="checkbox"/>	<input checked="" type="checkbox"/>

**FINISHES**

Full-height Cabinet:   
 Upper Millwork:   
 Countertop:   
 Lower Millwork:   
 Shelf:

Remarks: Refer to Schedule 1, Section 6.12 (Division 12) for Specialty Casework. Items indicated are diagrammatic, provide specialty casework appropriate for the specific and specialized functions to be performed in the space and to accommodate Equipment.

**MECHANICAL REQUIREMENTS**

<b>PLUMBING</b> (Quantity) <table border="1"> <tr> <td>Hand Hygiene Sink:</td> <td>Lavatory:</td> <td>Kitchen Sink:</td> <td>Seamless Kitchen Sink:</td> <td>Utility / Process Sink:</td> <td>Scrub Sink:</td> <td>Floor Sink:</td> </tr> <tr> <td>1</td> <td></td> <td></td> <td></td> <td></td> <td></td> <td></td> </tr> </table>		Hand Hygiene Sink:	Lavatory:	Kitchen Sink:	Seamless Kitchen Sink:	Utility / Process Sink:	Scrub Sink:	Floor Sink:	1							Other Fixtures: <input type="checkbox"/> Shower <input type="checkbox"/> Eyewash Station <input type="checkbox"/> Tub <input type="checkbox"/> Eyewash/Shower Station <input type="checkbox"/> Ice Maker <input type="checkbox"/> Emergency Shower <input type="checkbox"/> Water Closet <input type="checkbox"/> Flush Rim Sink <input type="checkbox"/> Instantaneous Hot Water <input type="checkbox"/> Floor Drain <input type="checkbox"/> <input type="checkbox"/> Water Bottle Refill Station Other: <input type="text"/>		<b>MED / NON-MED GASES</b> (Quantity) <table border="1"> <tr> <td>Oxygen:</td> <td>Medical Air:</td> <td>Medical Vacuum:</td> <td>Nitrous Oxide:</td> <td>CO2:</td> <td>AGSS:</td> <td>Nitrogen:</td> <td>Laboratory Air:</td> <td>Laboratory Vacuum:</td> <td>Utility Compressed Air:</td> </tr> <tr> <td></td> <td></td> <td></td> <td></td> <td></td> <td></td> <td></td> <td></td> <td></td> <td></td> </tr> </table>		Oxygen:	Medical Air:	Medical Vacuum:	Nitrous Oxide:	CO2:	AGSS:	Nitrogen:	Laboratory Air:	Laboratory Vacuum:	Utility Compressed Air:										
Hand Hygiene Sink:	Lavatory:	Kitchen Sink:	Seamless Kitchen Sink:	Utility / Process Sink:	Scrub Sink:	Floor Sink:																																	
1																																							
Oxygen:	Medical Air:	Medical Vacuum:	Nitrous Oxide:	CO2:	AGSS:	Nitrogen:	Laboratory Air:	Laboratory Vacuum:	Utility Compressed Air:																														
Plumbing Remarks: <input type="text" value="Provide portable eyewash station in all Medication Room"/>		Gas Remarks: <input type="text"/>																																					

**Appendix 1B Minimum Room Requirements**

Room Name: Medication Room - Small

Program Number(s):

1. B2.17	7.	13.	19.	25.	31.	37.	43.
2. C5.06	8.	14.	20.	26.	32.	38.	44.
3. L2.18	9.	15.	21.	27.	33.	39.	45.
4.	10.	16.	22.	28.	34.	40.	46.
5.	11.	17.	23.	29.	35.	41.	47.
6.	12.	18.	24.	30.	36.	42.	48.

**ARCHITECTURAL REQUIREMENTS**

<b>WALL AND CEILING</b> Wall Material: ARGB 1.2m AFF, GB above Ceiling Material: ACT Finish: PT Finish: PF	<b>WALL PROTECTION</b> Type: FRP Height: 1350 mm <input checked="" type="checkbox"/> Corner Guards <input type="checkbox"/> Hand Rails <input type="checkbox"/> Bed Bumper / Locator <input type="checkbox"/> Crash Rails <input type="checkbox"/> Chair Rail	<b>GLAZING</b> <input checked="" type="checkbox"/> Interior Glazing	<b>FLOORING TYPES</b> Material: VSF Base: FCB	<b>ROOM ACCESSORIES</b> <input type="checkbox"/> Coat Hooks <input type="checkbox"/> Ceiling Lift <input checked="" type="checkbox"/> Magnetic Whiteboard <input type="checkbox"/> Mirror <input type="checkbox"/> Infant Change Table <input type="checkbox"/> Privacy Curtain
--	--	--	---	---

- LEGEND:**
- WALL AND CEILING LEGEND:**
- AC Architectural Ceiling
  - ACT Acoustic Ceiling Tile
  - ACT-C Cleanroom
  - ARGB Abuse-Resistant Gypsum Board
  - GB Gypsum Board
  - IRGB Impact-Resistant Gypsum Board
  - KLCT Kitchen Lay-in Ceiling Tile
  - MMRGB Moisture and Mould-Resistant Gypsum Board
  - SACT Security Acoustic Ceiling Tile
- WALL FINISHES LEGEND:**
- EWC Epoxy Wall Coating
  - HPC High Performance Coating
  - PT Paint
- CEILING FINISHES LEGEND:**
- ECC Epoxy Ceiling Coating
  - HPC High Performance Coating
  - PF Prefinished
  - PT Paint
- WALL PROTECTION LEGEND:**
- ESRP Extruded Semi-Rigid PVCu Panel
  - FRL Fibre Reinforced Laminiate
  - FRP Fibreglass Reinforced Plastic
  - PVV Protective Vinyl Wallcovering
  - RHIS Rigid High Impact Sheet
  - WSSP Wetwall Solid Surface Panel
  - WWW Wetroom Vinyl Wallcovering
- FLOOR FINISHES LEGEND:**
- CFS Concrete Floor Sealer
  - EFC Epoxy Floor Coating
  - PFC Polyurethane Floor Coating
  - RAF Rubber Athletic Flooring
  - RSF Rubber Sheet Flooring
  - SCF Seamless Cushioned Flooring
  - SDRF Static-Dissipative Rubber Sheet Flooring
  - SDVF Static-Dissipative Vinyl Sheet Flooring
  - VSF Vinyl Sheet Flooring
  - WSVF Wetroom Safety Vinyl Sheet Flooring
- FLOOR BASE LEGEND:**
- FCB Flash Cove Base
  - RB Rubber Base
  - SCF Seamless Cushioned Flooring

**DOORS**

Types:

Type	Qty	Size (mm)	Material	Finish	Side Lt	Blinds	Protect	Privacy Film	Function	Card Reader	Mag Lock	Auto Opener	Hold Open	Hinges	Accessory 1	Accessory 2	Accessory 3	Closer
B	1	1065 x 2135	Solid Core	FRL			2 High		Storeroom	<input checked="" type="checkbox"/>		<input checked="" type="checkbox"/>		Butt Hinge	Elec. Strike			Surface

Door Remarks:

Security Grille  
 Anti-barricade strategy

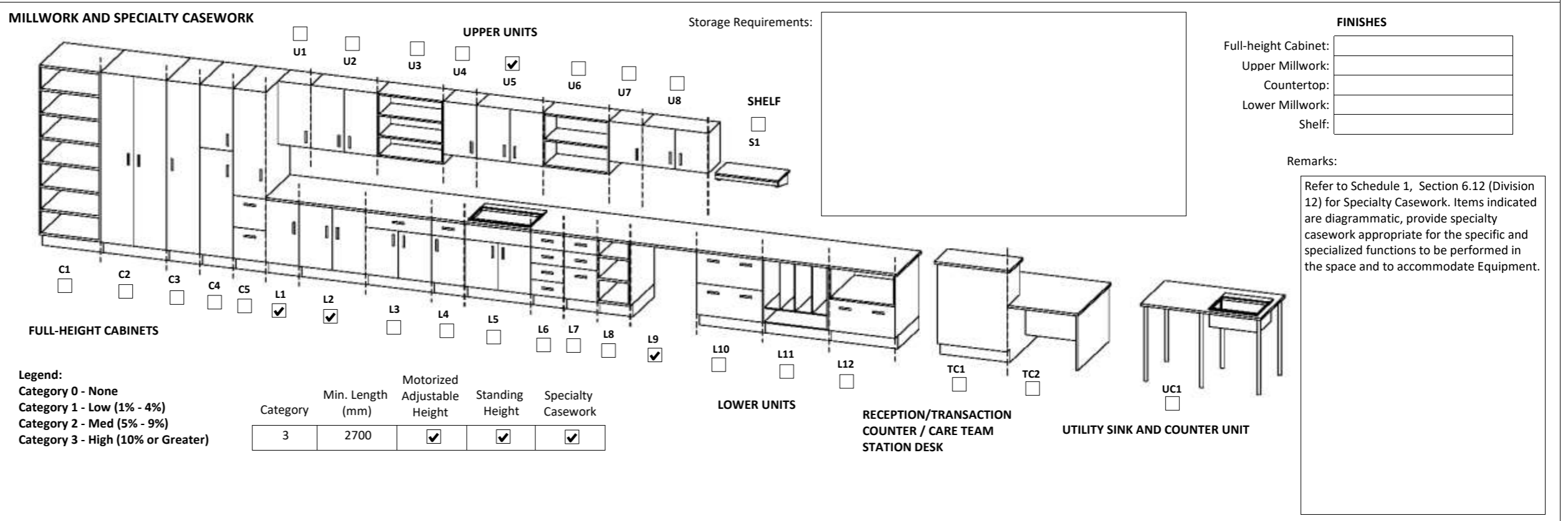

**MECHANICAL REQUIREMENTS**

<b>PLUMBING</b> (Quantity) Hand Hygiene Sink: 1 Lavatory: _____ Kitchen Sink: _____ Kitchen Sink: _____ Utility / Process Sink: _____ Scrub Sink: _____ Floor Sink: _____ Plumbing Remarks: Provide portable eyewash station in all Medication Room - Small	Other Fixtures: <input type="checkbox"/> Shower <input type="checkbox"/> Tub <input type="checkbox"/> Ice Maker <input type="checkbox"/> Water Closet <input type="checkbox"/> Instantaneous Hot Water <input type="checkbox"/> Eyewash Station <input type="checkbox"/> Eyewash/Shower Station <input type="checkbox"/> Emergency Shower <input type="checkbox"/> Flush Rim Sink <input type="checkbox"/> Floor Drain <input type="checkbox"/> Water Bottle Refill Station Other: _____	<b>MED / NON-MED GASES</b> (Quantity) Oxygen: _____ Medical Air: _____ Medical Vacuum: _____ Nitrous Oxide: _____ CO2: _____ AGSS: _____ Nitrogen: _____ Laboratory Air: _____ Laboratory Vacuum: _____ Utility Compressed Air: _____ Gas Remarks: _____
--	--	--



**Appendix 1B Minimum Room Requirements**

Room Name: Meeting Room - 12-Seat

Program Number(s):

1. B4.06	7. R4.06	13.	19.	25.	31.	37.	43.
2. C8.01	8. W4.12	14.	20.	26.	32.	38.	44.
3. D7.01	9.	15.	21.	27.	33.	39.	45.
4. E7.07	10.	16.	22.	28.	34.	40.	46.
5. F8.08	11.	17.	23.	29.	35.	41.	47.
6. H1.05	12.	18.	24.	30.	36.	42.	48.

**ARCHITECTURAL REQUIREMENTS**

<b>WALL AND CEILING</b> Wall Material: GB Ceiling Material: ACT Finish: PT Finish: PF	<b>WALL PROTECTION</b> Type: FRP Height: 1350 mm <input checked="" type="checkbox"/> Corner Guards <input checked="" type="checkbox"/> Crash Rails <input type="checkbox"/> Hand Rails <input type="checkbox"/> Chair Rail <input type="checkbox"/> Bed Bumper / Locator	<b>GLAZING</b> <input type="checkbox"/> Interior Glazing	<b>FLOORING TYPES</b> Material: RSF Base: RB	<b>ROOM ACCESSORIES</b> <input type="checkbox"/> Coat Hooks <input type="checkbox"/> Mirror <input checked="" type="checkbox"/> Ceiling Lift <input type="checkbox"/> Infant Change Table <input checked="" type="checkbox"/> Magnetic Whiteboard <input type="checkbox"/> Privacy Curtain
---	---	---	--	--

- LEGEND:**
- WALL AND CEILING LEGEND:**
- AC Architectural Ceiling
  - ACT Acoustic Ceiling Tile
  - ACT-C Cleanroom
  - ARGB Abuse-Resistant Gypsum Board
  - GB Gypsum Board
  - IRGB Impact-Resistant Gypsum Board
  - KLCT Kitchen Lay-in Ceiling Tile
  - MMRGB Moisture and Mould-Resistant Gypsum Board
  - SACT Security Acoustic Ceiling Tile
- WALL FINISHES LEGEND:**
- EWC Epoxy Wall Coating
  - HPC High Performance Coating
  - PT Paint
- CEILING FINISHES LEGEND:**
- ECC Epoxy Ceiling Coating
  - HPC High Performance Coating
  - PF Prefinished
  - PT Paint
- WALL PROTECTION LEGEND:**
- ESRP Extruded Semi-Rigid PVCu Panel
  - FRL Fibre Reinforced Laminate
  - FRP Fibreglass Reinforced Plastic
  - PVV Protective Vinyl Wallcovering
  - RHIS Rigid High Impact Sheet
  - WSSP Wetwall Solid Surface Panel
  - WWW Wetroom Vinyl Wallcovering
- FLOOR FINISHES LEGEND:**
- CFS Concrete Floor Sealer
  - EFC Epoxy Floor Coating
  - PFC Polyurethane Floor Coating
  - RAF Rubber Athletic Flooring
  - RSF Rubber Sheet Flooring
  - SCF Seamless Cushioned Flooring
  - SDRF Static-Dissipative Rubber Sheet Flooring
  - SDVF Static-Dissipative Vinyl Sheet Flooring
  - VSF Vinyl Sheet Flooring
  - WSVF Wetroom Safety Vinyl Sheet Flooring
- FLOOR BASE LEGEND:**
- FCB Flash Cove Base
  - RB Rubber Base
  - SCF Seamless Cushioned Flooring

**DOORS**

Types:

Type	Qty	Size (mm)	Material	Finish	Side Lt.	Blinds	Protect.	Privacy Film	Function	Card Reader	Mag Lock	Auto Opener	Hold Open	Hinges	Accessory 1	Accessory 2	Accessory 3	Closer
C	1	915 x 2135	Solid Core	FRL			1 Low		Storeroom	<input checked="" type="checkbox"/>	<input type="checkbox"/>	<input type="checkbox"/>	<input type="checkbox"/>	Butt Hinge				Surface

**Door Remarks:**  
B4.06 - Meeting room on middle floor to have a ceiling lift, crash rails, and F2 door (1530 x 2135 opening) with hold open hardware

- Security Grille
- Anti-barricade strategy

**MILLWORK AND SPECIALTY CASEWORK**

**UPPER UNITS:** U1, U2, U3, U4, U5, U6, U7, U8

**LOWER UNITS:** L1, L2, L3, L4, L5, L6, L7, L8, L9, L10, L11, L12

**RECEPTION/TRANSACTION COUNTER / CARE TEAM STATION DESK:** TC1, TC2

**UTILITY SINK AND COUNTER UNIT:** UC1

**SHELF:** S1

**Storage Requirements:**

**FINISHES**

Full-height Cabinet: \_\_\_\_\_  
 Upper Millwork: \_\_\_\_\_  
 Countertop: \_\_\_\_\_  
 Lower Millwork: \_\_\_\_\_  
 Shelf: \_\_\_\_\_

**Remarks:**  
One (1) Meeting Room - 12-Seat located on the middle floor of (3) 48-Bed Shared Support Spaces will include a ceiling lift for Staff training and will allow a stretcher through the door. Room F8.08 will require interior glazing with integral blinds.

**MECHANICAL REQUIREMENTS**

<b>PLUMBING</b> (Quantity) Hand Hygiene Sink: _____ Lavatory: _____ Kitchen Sink: _____ Seamless Kitchen Sink: _____ Utility / Process Sink: _____ Scrub Sink: _____ Floor Sink: _____ Plumbing Remarks: _____	Other Fixtures: <input type="checkbox"/> Shower <input type="checkbox"/> Tub <input type="checkbox"/> Ice Maker <input type="checkbox"/> Water Closet <input type="checkbox"/> Instantaneous Hot Water <input type="checkbox"/> Eyewash Station <input type="checkbox"/> Eyewash/Shower Station <input type="checkbox"/> Emergency Shower <input type="checkbox"/> Flush Rim Sink <input type="checkbox"/> Floor Drain <input type="checkbox"/> Water Bottle Refill Station Other: _____	<b>MED / NON-MED GASES</b> (Quantity) Oxygen: _____ Medical Air: _____ Medical Vacuum: _____ Nitrous Oxide: _____ CO2: _____ AGSS: _____ Nitrogen: _____ Laboratory Air: _____ Laboratory Vacuum: _____ Utility Compressed Air: _____ Gas Remarks: _____
---	--	--

**Appendix 1B Minimum Room Requirements**

Room Name: Meeting Room - 15-Seat

Program Number(s):

1. V1.07	7.	13.	19.	25.	31.	37.	43.
2.	8.	14.	20.	26.	32.	38.	44.
3.	9.	15.	21.	27.	33.	39.	45.
4.	10.	16.	22.	28.	34.	40.	46.
5.	11.	17.	23.	29.	35.	41.	47.
6.	12.	18.	24.	30.	36.	42.	48.

**ARCHITECTURAL REQUIREMENTS**

<b>WALL AND CEILING</b> Wall Material: <input type="text" value="GB"/> Finish: <input type="text" value="PT"/> Ceiling Material: <input type="text" value="ACT"/> Finish: <input type="text" value="PF"/>	<b>WALL PROTECTION</b> Type: <input type="text"/> Height: <input type="text"/> <input checked="" type="checkbox"/> Corner Guards <input type="checkbox"/> Hand Rails <input type="checkbox"/> Bed Bumper / Locator <input type="checkbox"/> Crash Rails <input checked="" type="checkbox"/> Chair Rail	<b>GLAZING</b> <input type="checkbox"/> Interior Glazing	<b>FLOORING TYPES</b> Material: <input type="text" value="RSF"/> Base: <input type="text" value="RB"/>	<b>ROOM ACCESSORIES</b> <input checked="" type="checkbox"/> Coat Hooks <input type="checkbox"/> Ceiling Lift <input checked="" type="checkbox"/> Magnetic Whiteboard <input type="checkbox"/> Mirror <input type="checkbox"/> Infant Change Table <input type="checkbox"/> Privacy Curtain
---	---	---	---	--

- LEGEND:**
- WALL AND CEILING LEGEND:**
- AC Architectural Ceiling
  - ACT Acoustic Ceiling Tile
  - ACT-C Cleanroom
  - ARGB Abuse-Resistant Gypsum Board
  - GB Gypsum Board
  - IRGB Impact-Resistant Gypsum Board
  - KLCT Kitchen Lay-in Ceiling Tile
  - MMRGB Moisture and Mould-Resistant Gypsum Board
  - SACT Security Acoustic Ceiling Tile
- WALL FINISHES LEGEND:**
- EWC Epoxy Wall Coating
  - HPC High Performance Coating
  - PT Paint
- CEILING FINISHES LEGEND:**
- ECC Epoxy Ceiling Coating
  - HPC High Performance Coating
  - PF Prefinished
  - PT Paint
- WALL PROTECTION LEGEND:**
- ESRP Extruded Semi-Rigid PVCu Panel
  - FRL Fibre Reinforced Laminate
  - FRP Fibreglass Reinforced Plastic
  - PVV Protective Vinyl Wallcovering
  - RHIS Rigid High Impact Sheet
  - WSSP Wetwall Solid Surface Panel
  - WVV Wetroom Vinyl Wallcovering
- FLOOR FINISHES LEGEND:**
- CFS Concrete Floor Sealer
  - EFC Epoxy Floor Coating
  - PFC Polyurethane Floor Coating
  - RAF Rubber Athletic Flooring
  - RSF Rubber Sheet Flooring
  - SCF Seamless Cushioned Flooring
  - SDRF Static-Dissipative Rubber Sheet Flooring
  - SDVF Static-Dissipative Vinyl Sheet Flooring
  - VSF Vinyl Sheet Flooring
  - WSVF Wetroom Safety Vinyl Sheet Flooring
- FLOOR BASE LEGEND:**
- FCB Flash Cove Base
  - RB Rubber Base
  - SCF Seamless Cushioned Flooring

**DOORS**

Types:

Type	Qty	Size (mm)	Material	Finish	Side Lt	Blinds	Protect	Privacy Film	Function	Card Reader	Mag Lock	Auto Opener	Hold Open	Hinges	Accessory 1	Accessory 2	Accessory 3	Closer
C	1	915 x 2135	Solid Core	FRL	<input type="checkbox"/>	<input type="checkbox"/>	1 Low	<input type="checkbox"/>	Storeroom	<input checked="" type="checkbox"/>	<input type="checkbox"/>	<input type="checkbox"/>	<input type="checkbox"/>	Butt Hinge				Surface

Door Remarks:  Security Grille  Anti-barricade strategy



**MECHANICAL REQUIREMENTS**

<b>PLUMBING</b> (Quantity) Hand Hygiene Sink: <input type="text"/> Lavatory: <input type="text"/> Kitchen Sink: <input type="text"/> Seamless Kitchen Sink: <input type="text"/> Utility / Process Sink: <input type="text"/> Scrub Sink: <input type="text"/> Floor Sink: <input type="text"/> Plumbing Remarks: <input type="text"/>	Other Fixtures: <input type="checkbox"/> Shower <input type="checkbox"/> Tub <input type="checkbox"/> Ice Maker <input type="checkbox"/> Water Closet <input type="checkbox"/> Instantaneous Hot Water <input type="checkbox"/> Eyewash Station <input type="checkbox"/> Eyewash/Shower Station <input type="checkbox"/> Emergency Shower <input type="checkbox"/> Flush Rim Sink <input type="checkbox"/> Floor Drain <input type="checkbox"/> Water Bottle Refill Station Other: <input type="text"/>	<b>MED / NON-MED GASES</b> (Quantity) Oxygen: <input type="text"/> Medical Air: <input type="text"/> Medical Vacuum: <input type="text"/> Nitrous Oxide: <input type="text"/> CO2: <input type="text"/> AGSS: <input type="text"/> Nitrogen: <input type="text"/> Laboratory Air: <input type="text"/> Laboratory Vacuum: <input type="text"/> Utility Compressed Air: <input type="text"/> Gas Remarks: <input type="text"/>
--	--	---

**Appendix 1B Minimum Room Requirements**

Room Name:

Program Number(s):

1. K1.12	7.	13.	19.	25.	31.	37.	43.
2.	8.	14.	20.	26.	32.	38.	44.
3.	9.	15.	21.	27.	33.	39.	45.
4.	10.	16.	22.	28.	34.	40.	46.
5.	11.	17.	23.	29.	35.	41.	47.
6.	12.	18.	24.	30.	36.	42.	48.

**ARCHITECTURAL REQUIREMENTS**

<b>WALL AND CEILING</b> Wall Material: <input type="text" value="GB"/> Finish: <input type="text" value="PT"/> Ceiling Material: <input type="text" value="ACT"/> Finish: <input type="text" value="PF"/>	<b>WALL PROTECTION</b> Type: <input type="text"/> Height: <input type="text"/> <input checked="" type="checkbox"/> Corner Guards <input type="checkbox"/> Hand Rails <input type="checkbox"/> Bed Bumper / Locator <input type="checkbox"/> Crash Rails <input checked="" type="checkbox"/> Chair Rail	<b>GLAZING</b> <input type="checkbox"/> Interior Glazing	<b>FLOORING TYPES</b> Material: <input type="text" value="RSF"/> Base: <input type="text" value="RB"/>	<b>ROOM ACCESSORIES</b> <input checked="" type="checkbox"/> Coat Hooks <input type="checkbox"/> Ceiling Lift <input checked="" type="checkbox"/> Magnetic Whiteboard <input type="checkbox"/> Mirror <input type="checkbox"/> Infant Change Table <input type="checkbox"/> Privacy Curtain
---	---	---	---	--

- LEGEND:**
- WALL AND CEILING LEGEND:**
- AC Architectural Ceiling
  - ACT Acoustic Ceiling Tile
  - ACT-C Cleanroom
  - ARGB Abuse-Resistant Gypsum Board
  - GB Gypsum Board
  - IRGB Impact-Resistant Gypsum Board
  - KLCT Kitchen Lay-in Ceiling Tile
  - MMRGB Moisture and Mould-Resistant Gypsum Board
  - SACT Security Acoustic Ceiling Tile
- WALL FINISHES LEGEND:**
- EWC Epoxy Wall Coating
  - HPC High Performance Coating
  - PT Paint
- CEILING FINISHES LEGEND:**
- ECC Epoxy Ceiling Coating
  - HPC High Performance Coating
  - PF Prefinished
  - PT Paint
- WALL PROTECTION LEGEND:**
- ESRP Extruded Semi-Rigid PVCu Panel
  - FRL Fibre Reinforced Laminata
  - FRP Fibreglass Reinforced Plastic
  - PVV Protective Vinyl Wallcovering
  - RHIS Rigid High Impact Sheet
  - WSSP Wetwall Solid Surface Panel
  - WVV Wetroom Vinyl Wallcovering
- FLOOR FINISHES LEGEND:**
- CFS Concrete Floor Sealer
  - EFC Epoxy Floor Coating
  - PFC Polyurethane Floor Coating
  - RAF Rubber Athletic Flooring
  - RSF Rubber Sheet Flooring
  - SCF Seamless Cushioned Flooring
  - SDRF Static-Dissipative Rubber Sheet Flooring
  - SDVF Static-Dissipative Vinyl Sheet Flooring
  - VSF Vinyl Sheet Flooring
  - WSVF Wetroom Safety Vinyl Sheet Flooring
- FLOOR BASE LEGEND:**
- FCB Flash Cove Base
  - RB Rubber Base
  - SCF Seamless Cushioned Flooring

**DOORS**

Types:

Type	Qty	Size (mm)	Material	Finish	Side Lt.	Blinds	Protect.	Privacy Film	Function	Card Reader	Mag Lock	Auto Opener	Hold Open	Hinges	Accessory 1	Accessory 2	Accessory 3	Closer
C	1	915 x 2135	Solid Core	FRL	<input type="checkbox"/>	<input type="checkbox"/>	1 Low	<input type="checkbox"/>	Storeroom	<input checked="" type="checkbox"/>	<input type="checkbox"/>	<input type="checkbox"/>	<input type="checkbox"/>	Butt Hinge				Surface

Door Remarks:

Security Grille  
 Anti-barricade strategy

**MILLWORK AND SPECIALTY CASEWORK**

**UPPER UNITS** (U1-U8) **LOWER UNITS** (L1-L12) **RECEPTION/TRANSACTION COUNTER / CARE TEAM STATION DESK** (TC1-TC2) **UTILITY SINK AND COUNTER UNIT** (UC1)

Storage Requirements:

**FINISHES**

Full-height Cabinet:   
 Upper Millwork:   
 Countertop:   
 Lower Millwork:   
 Shelf:

Remarks:

**Legend:**

Category	Min. Length (mm)	Motorized Adjustable Height	Standing Height	Specialty Casework
Category 0 - None		<input type="checkbox"/>	<input type="checkbox"/>	<input type="checkbox"/>
Category 1 - Low (1% - 4%)		<input type="checkbox"/>	<input type="checkbox"/>	<input type="checkbox"/>
Category 2 - Med (5% - 9%)		<input type="checkbox"/>	<input type="checkbox"/>	<input type="checkbox"/>
Category 3 - High (10% or Greater)		<input type="checkbox"/>	<input type="checkbox"/>	<input type="checkbox"/>

**MECHANICAL REQUIREMENTS**

<b>PLUMBING</b> (Quantity) Hand Hygiene Sink: <input type="text"/> Lavatory: <input type="text"/> Kitchen Sink: <input type="text"/> Seamless Kitchen Sink: <input type="text"/> Utility / Process Sink: <input type="text"/> Scrub Sink: <input type="text"/> Floor Sink: <input type="text"/> Plumbing Remarks: <input type="text"/>	Other Fixtures: <input type="checkbox"/> Shower <input type="checkbox"/> Eyewash Station <input type="checkbox"/> Tub <input type="checkbox"/> Eyewash/Shower Station <input type="checkbox"/> Ice Maker <input type="checkbox"/> Emergency Shower <input type="checkbox"/> Water Closet <input type="checkbox"/> Flush Rim Sink <input type="checkbox"/> Instantaneous Hot Water <input type="checkbox"/> Floor Drain <input type="checkbox"/> <input type="checkbox"/> Water Bottle Refill Station Other <input type="text"/>	<b>MED / NON-MED GASES</b> (Quantity) Oxygen: <input type="text"/> Medical Air: <input type="text"/> Medical Vacuum: <input type="text"/> Nitrous Oxide: <input type="text"/> CO2: <input type="text"/> AGSS: <input type="text"/> Nitrogen: <input type="text"/> Laboratory Air: <input type="text"/> Laboratory Vacuum: <input type="text"/> Utility Compressed Air: <input type="text"/> Gas Remarks: <input type="text"/>
---	--	---



**Appendix 1B Minimum Room Requirements**

Room Name:

Program Number(s):

1. V1.06	7.	13.	19.	25.	31.	37.	43.
2.	8.	14.	20.	26.	32.	38.	44.
3.	9.	15.	21.	27.	33.	39.	45.
4.	10.	16.	22.	28.	34.	40.	46.
5.	11.	17.	23.	29.	35.	41.	47.
6.	12.	18.	24.	30.	36.	42.	48.

**ARCHITECTURAL REQUIREMENTS**

<b>WALL AND CEILING</b> Wall Material: <input type="text" value="GB"/> Finish: <input type="text" value="PT"/> Ceiling Material: <input type="text" value="ACT"/> Finish: <input type="text" value="PF"/>	<b>WALL PROTECTION</b> Type: <input type="text"/> Height: <input type="text"/> <input checked="" type="checkbox"/> Corner Guards <input type="checkbox"/> Hand Rails <input type="checkbox"/> Bed Bumper / Locator <input type="checkbox"/> Crash Rails <input checked="" type="checkbox"/> Chair Rail	<b>GLAZING</b> <input type="checkbox"/> Interior Glazing	<b>FLOORING TYPES</b> Material: <input type="text" value="RSF"/> Base: <input type="text" value="RB"/>	<b>ROOM ACCESSORIES</b> <input checked="" type="checkbox"/> Coat Hooks <input type="checkbox"/> Ceiling Lift <input checked="" type="checkbox"/> Magnetic Whiteboard <input type="checkbox"/> Mirror <input type="checkbox"/> Infant Change Table <input type="checkbox"/> Privacy Curtain
---	---	---	---	--

- LEGEND:**
- WALL AND CEILING LEGEND:**
- AC Architectural Ceiling
  - ACT Acoustic Ceiling Tile
  - ACT-C Cleanroom
  - ARGB Abuse-Resistant Gypsum Board
  - GB Gypsum Board
  - IRGB Impact-Resistant Gypsum Board
  - KLCT Kitchen Lay-in Ceiling Tile
  - MMRGB Moisture and Mould-Resistant Gypsum Board
  - SACT Security Acoustic Ceiling Tile
- WALL FINISHES LEGEND:**
- EWC Epoxy Wall Coating
  - HPC High Performance Coating
  - PT Paint
- CEILING FINISHES LEGEND:**
- ECC Epoxy Ceiling Coating
  - HPC High Performance Coating
  - PF Prefinished
  - PT Paint
- WALL PROTECTION LEGEND:**
- ESRP Extruded Semi-Rigid PVCu Panel
  - FRL Fibre Reinforced Laminate
  - FRP Fibreglass Reinforced Plastic
  - PVV Protective Vinyl Wallcovering
  - RHIS Rigid High Impact Sheet
  - WSSP Wetwall Solid Surface Panel
  - WVV Wetroom Vinyl Wallcovering
- FLOOR FINISHES LEGEND:**
- CFS Concrete Floor Sealer
  - EFC Epoxy Floor Coating
  - PFC Polyurethane Floor Coating
  - RAF Rubber Athletic Flooring
  - RSF Rubber Sheet Flooring
  - SCF Seamless Cushioned Flooring
  - SDRF Static-Dissipative Rubber Sheet Flooring
  - SDVF Static-Dissipative Vinyl Sheet Flooring
  - VSF Vinyl Sheet Flooring
  - WSVF Wetroom Safety Vinyl Sheet Flooring
- FLOOR BASE LEGEND:**
- FCB Flash Cove Base
  - RB Rubber Base
  - SCF Seamless Cushioned Flooring

**DOORS**

Types:

Type	Qty	Size (mm)	Material	Finish	Side Lt.	Blinds	Protect.	Privacy Film	Function	Card Reader	Mag Lock	Auto Opener	Hold Open	Hinges	Accessory 1	Accessory 2	Accessory 3	Closer
C	2	915 x 2135	Solid Core	FRL	<input type="checkbox"/>	<input type="checkbox"/>	1 Low	<input type="checkbox"/>	Storeroom	<input checked="" type="checkbox"/>	<input type="checkbox"/>	<input type="checkbox"/>	<input type="checkbox"/>	Butt Hinge				Surface

Door Remarks:

Security Grille  
 Anti-barricade strategy

**MILLWORK AND SPECIALTY CASEWORK**

Storage Requirements:

**UPPER UNITS** (U1-U8)

**LOWER UNITS** (L1-L9)

**RECEPTION/TRANSACTION COUNTER / CARE TEAM STATION DESK** (TC1, TC2)

**UTILITY SINK AND COUNTER UNIT** (UC1)

**SHELF** (S1)

**FULL-HEIGHT CABINETS** (C1-C5)

**Legend:**

Category	Min. Length (mm)	Motorized Adjustable Height	Standing Height	Specialty Casework
1	2400	<input type="checkbox"/>	<input type="checkbox"/>	<input type="checkbox"/>

**FINISHES**

Full-height Cabinet:

Upper Millwork:

Countertop:

Lower Millwork:

Shelf:

Remarks: Refer to Appendix 1A, Section 2.22 V. Meeting and Education for operable partition requirements

**MECHANICAL REQUIREMENTS**

<b>PLUMBING</b> (Quantity) Hand Hygiene Sink: <input type="text"/> Lavatory: <input type="text"/> Kitchen Sink: <input type="text"/> Seamless Kitchen Sink: <input type="text"/> Utility / Process Sink: <input type="text"/> Scrub Sink: <input type="text"/> Floor Sink: <input type="text"/> Plumbing Remarks: <input type="text"/>	Other Fixtures: <input type="checkbox"/> Shower <input type="checkbox"/> Tub <input type="checkbox"/> Ice Maker <input type="checkbox"/> Water Closet <input type="checkbox"/> Instantaneous Hot Water <input type="checkbox"/> Eyewash Station <input type="checkbox"/> Eyewash/Shower Station <input type="checkbox"/> Emergency Shower <input type="checkbox"/> Flush Rim Sink <input type="checkbox"/> Floor Drain <input type="checkbox"/> Water Bottle Refill Station Other: <input type="text"/>	<b>MED / NON-MED GASES</b> (Quantity) Oxygen: <input type="text"/> Medical Air: <input type="text"/> Medical Vacuum: <input type="text"/> Nitrous Oxide: <input type="text"/> CO2: <input type="text"/> AGSS: <input type="text"/> Nitrogen: <input type="text"/> Laboratory Air: <input type="text"/> Laboratory Vacuum: <input type="text"/> Utility Compressed Air: <input type="text"/> Gas Remarks: <input type="text"/>
---	---	---

**Appendix 1B Minimum Room Requirements**

Room Name:

Program Number(s):	1. K2.02	7.	13.	19.	25.	31.	37.	43.
	2. U5.02	8.	14.	20.	26.	32.	38.	44.
	3. U6.02	9.	15.	21.	27.	33.	39.	45.
	4.	10.	16.	22.	28.	34.	40.	46.
	5.	11.	17.	23.	29.	35.	41.	47.
	6.	12.	18.	24.	30.	36.	42.	48.

**ARCHITECTURAL REQUIREMENTS**

<b>WALL AND CEILING</b> Wall Material: <input type="text" value="GB"/> Finish: <input type="text" value="PT"/> Ceiling Material: <input type="text" value="ACT"/> Finish: <input type="text" value="PF"/>	<b>WALL PROTECTION</b> Type: <input type="text"/> Height: <input type="text"/> <input checked="" type="checkbox"/> Corner Guards <input type="checkbox"/> Hand Rails <input type="checkbox"/> Bed Bumper / Locator <input type="checkbox"/> Crash Rails <input checked="" type="checkbox"/> Chair Rail	<b>GLAZING</b> <input checked="" type="checkbox"/> Interior Glazing	<b>FLOORING TYPES</b> Material: <input type="text" value="RSF"/> Base: <input type="text" value="RB"/>	<b>ROOM ACCESSORIES</b> <input type="checkbox"/> Coat Hooks <input type="checkbox"/> Ceiling Lift <input checked="" type="checkbox"/> Magnetic Whiteboard <input type="checkbox"/> Mirror <input type="checkbox"/> Infant Change Table <input type="checkbox"/> Privacy Curtain
---	---	--	---	---

- LEGEND:**
- WALL AND CEILING LEGEND:**
- AC Architectural Ceiling
  - ACT Acoustic Ceiling Tile
  - ACT-C Cleanroom
  - ARGB Abuse-Resistant Gypsum Board
  - GB Gypsum Board
  - IRGB Impact-Resistant Gypsum Board
  - KLCT Kitchen Lay-in Ceiling Tile
  - MMRGB Moisture and Mould-Resistant Gypsum Board
  - SACT Security Acoustic Ceiling Tile
- WALL FINISHES LEGEND:**
- EWC Epoxy Wall Coating
  - HPC High Performance Coating
  - PT Paint
- CEILING FINISHES LEGEND:**
- ECC Epoxy Ceiling Coating
  - HPC High Performance Coating
  - PF Prefinished
  - PT Paint
- WALL PROTECTION LEGEND:**
- ESRP Extruded Semi-Rigid PVCu Panel
  - FRL Fibre Reinforced Laminate
  - FRP Fibreglass Reinforced Plastic
  - PVV Protective Vinyl Wallcovering
  - RHIS Rigid High Impact Sheet
  - WSSP Wetwall Solid Surface Panel
  - WVV Wetroom Vinyl Wallcovering
- FLOOR FINISHES LEGEND:**
- CFS Concrete Floor Sealer
  - EFC Epoxy Floor Coating
  - PFC Polyurethane Floor Coating
  - RAF Rubber Athletic Flooring
  - RSF Rubber Sheet Flooring
  - SCF Seamless Cushioned Flooring
  - SDRF Static-Dissipative Rubber Sheet Flooring
  - SDVF Static-Dissipative Vinyl Sheet Flooring
  - VSF Vinyl Sheet Flooring
  - WSVF Wetroom Safety Vinyl Sheet Flooring
- FLOOR BASE LEGEND:**
- FCB Flash Cove Base
  - RB Rubber Base
  - SCF Seamless Cushioned Flooring

**DOORS**

Types:

Type	Qty	Size (mm)	Material	Finish	Side Lt.	Blinds	Protect.	Film	Function	Card Reader	Mag Lock	Auto Opener	Hold Open	Hinges	Accessory 1	Accessory 2	Accessory 3	Closer
C	1	915 x 2135	Solid Core	FRL	<input type="checkbox"/>	<input type="checkbox"/>	1 Low	<input type="checkbox"/>	Storeroom	<input checked="" type="checkbox"/>	<input type="checkbox"/>	<input type="checkbox"/>	<input type="checkbox"/>	Butt Hinge				Surface

Door Remarks:

Security Grille  
 Anti-barricade strategy

**MILLWORK AND SPECIALTY CASEWORK**

**UPPER UNITS** (U1-U8) **LOWER UNITS** (L1-L12) **RECEPTION/TRANSACTION COUNTER / CARE TEAM STATION DESK** (TC1-TC2) **UTILITY SINK AND COUNTER UNIT** (UC1)

Storage Requirements:

**FINISHES**

Full-height Cabinet:   
 Upper Millwork:   
 Countertop:   
 Lower Millwork:   
 Shelf:

Remarks:

**Legend:**

Category	Min. Length (mm)	Motorized Adjustable Height	Standing Height	Specialty Casework
Category 0 - None		<input type="checkbox"/>	<input type="checkbox"/>	<input type="checkbox"/>
Category 1 - Low (1% - 4%)		<input type="checkbox"/>	<input type="checkbox"/>	<input type="checkbox"/>
Category 2 - Med (5% - 9%)		<input type="checkbox"/>	<input type="checkbox"/>	<input type="checkbox"/>
Category 3 - High (10% or Greater)		<input type="checkbox"/>	<input type="checkbox"/>	<input type="checkbox"/>

**MECHANICAL REQUIREMENTS**

<b>PLUMBING</b> (Quantity) Hand Hygiene Sink: <input type="text"/> Lavatory: <input type="text"/> Kitchen Sink: <input type="text"/> Seamless Kitchen Sink: <input type="text"/> Utility / Process Sink: <input type="text"/> Scrub Sink: <input type="text"/> Floor Sink: <input type="text"/> Plumbing Remarks: <input type="text"/>	Other Fixtures: <input type="checkbox"/> Shower <input type="checkbox"/> Tub <input type="checkbox"/> Ice Maker <input type="checkbox"/> Water Closet <input type="checkbox"/> Instantaneous Hot Water <input type="checkbox"/> Eyewash Station <input type="checkbox"/> Eyewash/Shower Station <input type="checkbox"/> Emergency Shower <input type="checkbox"/> Flush Rim Sink <input type="checkbox"/> Floor Drain <input type="checkbox"/> Water Bottle Refill Station Other: <input type="text"/>	<b>MED / NON-MED GASES</b> (Quantity) Oxygen: <input type="text"/> Medical Air: <input type="text"/> Medical Vacuum: <input type="text"/> Nitrous Oxide: <input type="text"/> CO2: <input type="text"/> AGSS: <input type="text"/> Nitrogen: <input type="text"/> Laboratory Air: <input type="text"/> Laboratory Vacuum: <input type="text"/> Utility Compressed Air: <input type="text"/> Gas Remarks: <input type="text"/>
--	--	---

**Appendix 1B Minimum Room Requirements**

Room Name: Meeting Room - 50-Seat

Program Number(s):	1. V1.05	7.	13.	19.	25.	31.	37.	43.
	2.	8.	14.	20.	26.	32.	38.	44.
	3.	9.	15.	21.	27.	33.	39.	45.
	4.	10.	16.	22.	28.	34.	40.	46.
	5.	11.	17.	23.	29.	35.	41.	47.
	6.	12.	18.	24.	30.	36.	42.	48.

**ARCHITECTURAL REQUIREMENTS**

<b>WALL AND CEILING</b> Wall Material: <input type="text" value="GB"/> Finish: <input type="text" value="PT"/> Ceiling Material: <input type="text" value="ACT"/> Finish: <input type="text" value="PF"/>	<b>WALL PROTECTION</b> Type: <input type="text"/> Height: <input type="text"/> <input checked="" type="checkbox"/> Corner Guards <input type="checkbox"/> Hand Rails <input type="checkbox"/> Bed Bumper / Locator <input type="checkbox"/> Crash Rails <input checked="" type="checkbox"/> Chair Rail	<b>GLAZING</b> <input type="checkbox"/> Interior Glazing	<b>FLOORING TYPES</b> Material: <input type="text" value="RSF"/> Base: <input type="text" value="RB"/>	<b>ROOM ACCESSORIES</b> <input checked="" type="checkbox"/> Coat Hooks <input type="checkbox"/> Ceiling Lift <input checked="" type="checkbox"/> Magnetic Whiteboard <input type="checkbox"/> Mirror <input type="checkbox"/> Infant Change Table <input type="checkbox"/> Privacy Curtain
---	---	---	---	--

- LEGEND:**
- WALL AND CEILING LEGEND:**
- AC Architectural Ceiling
  - ACT Acoustic Ceiling Tile
  - ACT-C Cleanroom
  - ARGB Abuse-Resistant Gypsum Board
  - GB Gypsum Board
  - IRGB Impact-Resistant Gypsum Board
  - KLCT Kitchen Lay-in Ceiling Tile
  - MMRGB Moisture and Mould-Resistant Gypsum Board
  - SACT Security Acoustic Ceiling Tile
- WALL FINISHES LEGEND:**
- EWC Epoxy Wall Coating
  - HPC High Performance Coating
  - PT Paint
- CEILING FINISHES LEGEND:**
- ECC Epoxy Ceiling Coating
  - HPC High Performance Coating
  - PF Prefinished
  - PT Paint
- WALL PROTECTION LEGEND:**
- ESRP Extruded Semi-Rigid PVCu Panel
  - FRL Fibre Reinforced Laminate
  - FRP Fibreglass Reinforced Plastic
  - PVV Protective Vinyl Wallcovering
  - RHIS Rigid High Impact Sheet
  - WSSP Wetwall Solid Surface Panel
  - WVV Wetroom Vinyl Wallcovering
- FLOOR FINISHES LEGEND:**
- CFS Concrete Floor Sealer
  - EFC Epoxy Floor Coating
  - PFC Polyurethane Floor Coating
  - RAF Rubber Athletic Flooring
  - RSF Rubber Sheet Flooring
  - SCF Seamless Cushioned Flooring
  - SDRF Static-Dissipative Rubber Sheet Flooring
  - SDVF Static-Dissipative Vinyl Sheet Flooring
  - VSF Vinyl Sheet Flooring
  - WSVF Wetroom Safety Vinyl Sheet Flooring
- FLOOR BASE LEGEND:**
- FCB Flash Cove Base
  - RB Rubber Base
  - SCF Seamless Cushioned Flooring

**DOORS**

Types:

Type	Qty	Size (mm)	Material	Finish	Side Lt.	Blinds	Protect.	Privacy Film	Function	Card Reader	Mag Lock	Auto Opener	Hold Open	Hinges	Accessory 1	Accessory 2	Accessory 3	Closer
C	2	915 x 2135	Solid Core	FRL	<input type="checkbox"/>	<input type="checkbox"/>	1 Low	<input type="checkbox"/>	Storeroom	<input checked="" type="checkbox"/>	<input type="checkbox"/>	<input type="checkbox"/>	<input type="checkbox"/>	Butt Hinge				Surface

Door Remarks:  Security Grille  Anti-barricade strategy

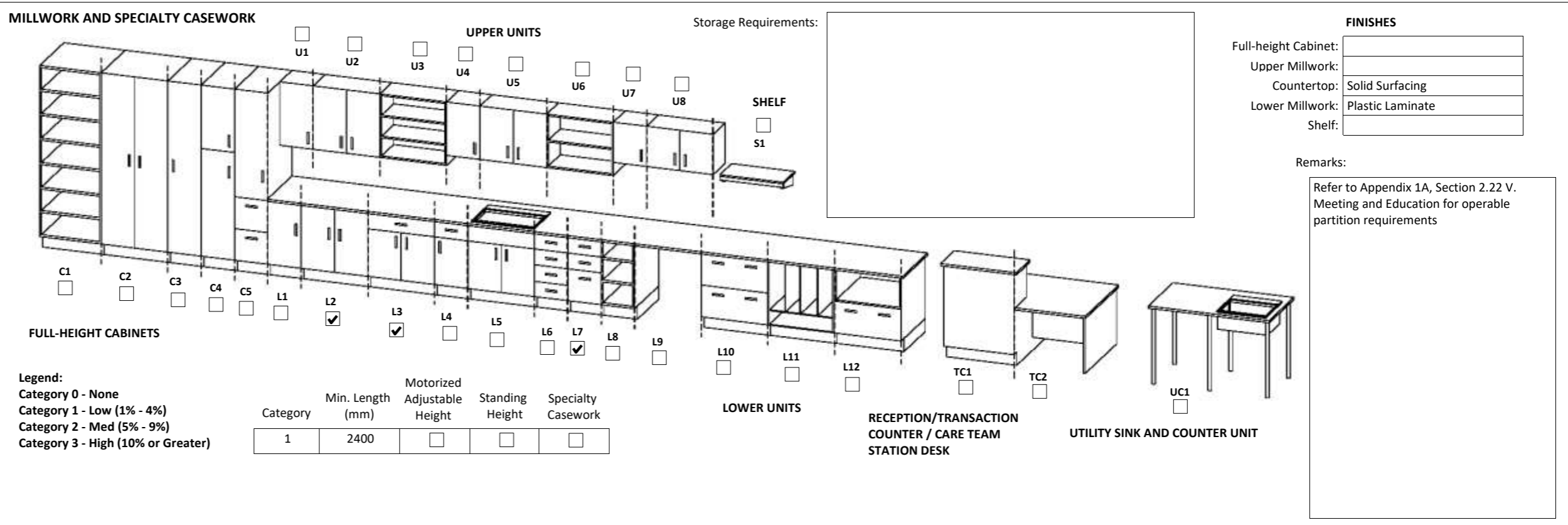

**MECHANICAL REQUIREMENTS**

<b>PLUMBING</b> (Quantity) Hand Hygiene Sink: <input type="text"/> Lavatory: <input type="text"/> Kitchen Sink: <input type="text"/> Seamless Kitchen Sink: <input type="text"/> Utility / Process Sink: <input type="text"/> Scrub Sink: <input type="text"/> Floor Sink: <input type="text"/> Plumbing Remarks: <input type="text"/>	Other Fixtures: <input type="checkbox"/> Shower <input type="checkbox"/> Tub <input type="checkbox"/> Ice Maker <input type="checkbox"/> Water Closet <input type="checkbox"/> Instantaneous Hot Water <input type="checkbox"/> Eyewash Station <input type="checkbox"/> Eyewash/Shower Station <input type="checkbox"/> Emergency Shower <input type="checkbox"/> Flush Rim Sink <input type="checkbox"/> Floor Drain <input type="checkbox"/> Water Bottle Refill Station Other: <input type="text"/>	<b>MED / NON-MED GASES</b> (Quantity) Oxygen: <input type="text"/> Medical Air: <input type="text"/> Medical Vacuum: <input type="text"/> Nitrous Oxide: <input type="text"/> CO2: <input type="text"/> AGSS: <input type="text"/> Nitrogen: <input type="text"/> Laboratory Air: <input type="text"/> Laboratory Vacuum: <input type="text"/> Utility Compressed Air: <input type="text"/> Gas Remarks: <input type="text"/>
--	--	---



**Appendix 1B Minimum Room Requirements**

Room Name:

Program Number(s):

1. G3.08	7.	13.	19.	25.	31.	37.	43.
2. N3.04	8.	14.	20.	26.	32.	38.	44.
3.	9.	15.	21.	27.	33.	39.	45.
4.	10.	16.	22.	28.	34.	40.	46.
5.	11.	17.	23.	29.	35.	41.	47.
6.	12.	18.	24.	30.	36.	42.	48.

**ARCHITECTURAL REQUIREMENTS**

<b>WALL AND CEILING</b> Wall Material: <input type="text" value="GB"/> Finish: <input type="text" value="PT"/> Ceiling Material: <input type="text" value="ACT"/> Finish: <input type="text" value="PF"/>	<b>WALL PROTECTION</b> Type: <input type="text"/> Height: <input type="text"/> <input checked="" type="checkbox"/> Corner Guards <input type="checkbox"/> Hand Rails <input type="checkbox"/> Bed Bumper / Locator <input type="checkbox"/> Crash Rails <input checked="" type="checkbox"/> Chair Rail	<b>GLAZING</b> <input type="checkbox"/> Interior Glazing	<b>FLOORING TYPES</b> Material: <input type="text" value="RSF"/> Base: <input type="text" value="RB"/>	<b>ROOM ACCESSORIES</b> <input type="checkbox"/> Coat Hooks <input type="checkbox"/> Ceiling Lift <input checked="" type="checkbox"/> Magnetic Whiteboard <input type="checkbox"/> Mirror <input type="checkbox"/> Infant Change Table <input type="checkbox"/> Privacy Curtain
---	---	---	---	---

- LEGEND:**
- WALL AND CEILING LEGEND:**
- AC Architectural Ceiling
  - ACT Acoustic Ceiling Tile
  - ACT-C Cleanroom
  - ARGB Abuse-Resistant Gypsum Board
  - GB Gypsum Board
  - IRGB Impact-Resistant Gypsum Board
  - KLCT Kitchen Lay-in Ceiling Tile
  - MMRGB Moisture and Mould-Resistant Gypsum Board
  - SACT Security Acoustic Ceiling Tile
- WALL FINISHES LEGEND:**
- EWC Epoxy Wall Coating
  - HPC High Performance Coating
  - PT Paint
- CEILING FINISHES LEGEND:**
- ECC Epoxy Ceiling Coating
  - HPC High Performance Coating
  - PF Prefinished
  - PT Paint
- WALL PROTECTION LEGEND:**
- ESRP Extruded Semi-Rigid PVCu Panel
  - FRL Fibre Reinforced Laminate
  - FRP Fibreglass Reinforced Plastic
  - PVV Protective Vinyl Wallcovering
  - RHIS Rigid High Impact Sheet
  - WSSP Wetwall Solid Surface Panel
  - WVV Wetroom Vinyl Wallcovering
- FLOOR FINISHES LEGEND:**
- CFS Concrete Floor Sealer
  - EFC Epoxy Floor Coating
  - PFC Polyurethane Floor Coating
  - RAF Rubber Athletic Flooring
  - RSF Rubber Sheet Flooring
  - SCF Seamless Cushioned Flooring
  - SDRF Static-Dissipative Rubber Sheet Flooring
  - SDVF Static-Dissipative Vinyl Sheet Flooring
  - VSF Vinyl Sheet Flooring
  - WSVF Wetroom Safety Vinyl Sheet Flooring
- FLOOR BASE LEGEND:**
- FCB Flash Cove Base
  - RB Rubber Base
  - SCF Seamless Cushioned Flooring

**DOORS**

Types:

Type	Qty	Size (mm)	Material	Finish	Side Lt.	Blinds	Protect.	Film	Function	Card Reader	Mag Lock	Auto Opener	Hold Open	Hinges	Accessory 1	Accessory 2	Accessory 3	Closer
C	1	915 x 2135	Solid Core	FRL	<input type="checkbox"/>	<input type="checkbox"/>	1 Low	<input type="checkbox"/>	Storeroom	<input checked="" type="checkbox"/>	<input type="checkbox"/>	<input type="checkbox"/>	<input type="checkbox"/>	Butt Hinge				Surface

**DOOR REMARKS:**

Security Grille  
 Anti-barricade strategy



**MECHANICAL REQUIREMENTS**

<b>PLUMBING</b> (Quantity) Hand Hygiene Sink: <input type="text"/> Lavatory: <input type="text"/> Kitchen Sink: <input type="text"/> Seamless Kitchen Sink: <input type="text"/> Utility / Process Sink: <input type="text"/> Scrub Sink: <input type="text"/> Floor Sink: <input type="text"/> Plumbing Remarks: <input type="text"/>	Other Fixtures: <input type="checkbox"/> Shower <input type="checkbox"/> Tub <input type="checkbox"/> Ice Maker <input type="checkbox"/> Water Closet <input type="checkbox"/> Instantaneous Hot Water <input type="checkbox"/> Ewewash Station <input type="checkbox"/> Ewewash/Shower Station <input type="checkbox"/> Emergency Shower <input type="checkbox"/> Flush Rim Sink <input type="checkbox"/> Floor Drain <input type="checkbox"/> Water Bottle Refill Station Other: <input type="text"/>	<b>MED / NON-MED GASES</b> (Quantity) Oxygen: <input type="text"/> Medical Air: <input type="text"/> Medical Vacuum: <input type="text"/> Nitrous Oxide: <input type="text"/> CO2: <input type="text"/> AGSS: <input type="text"/> Nitrogen: <input type="text"/> Laboratory Air: <input type="text"/> Laboratory Vacuum: <input type="text"/> Utility Compressed Air: <input type="text"/> Gas Remarks: <input type="text"/>
---	---	---

# Appendix 1B Minimum Room Requirements

Room Name:

Program Number(s):

1. A4.02	7.	13.	19.	25.	31.	37.	43.
2. L3.06	8.	14.	20.	26.	32.	38.	44.
3. P4.02	9.	15.	21.	27.	33.	39.	45.
4. P4.04	10.	16.	22.	28.	34.	40.	46.
5. S2.02	11.	17.	23.	29.	35.	41.	47.
6. U2.06	12.	18.	24.	30.	36.	42.	48.

## ARCHITECTURAL REQUIREMENTS

<b>WALL AND CEILING</b> Wall Material: <input type="text" value="GB"/> Finish: <input type="text" value="PT"/> Ceiling Material: <input type="text" value="ACT"/> Finish: <input type="text" value="PF"/>	<b>WALL PROTECTION</b> Type: <input type="text"/> Height: <input type="text"/> <input checked="" type="checkbox"/> Corner Guards <input type="checkbox"/> Hand Rails <input type="checkbox"/> Bed Bumper / Locator <input type="checkbox"/> Crash Rails <input checked="" type="checkbox"/> Chair Rail	<b>GLAZING</b> <input type="checkbox"/> Interior Glazing	<b>FLOORING TYPES</b> Material: <input type="text" value="RSF"/> Base: <input type="text" value="RB"/>	<b>ROOM ACCESSORIES</b> <input type="checkbox"/> Coat Hooks <input type="checkbox"/> Ceiling Lift <input checked="" type="checkbox"/> Magnetic Whiteboard <input type="checkbox"/> Mirror <input type="checkbox"/> Infant Change Table <input type="checkbox"/> Privacy Curtain
---	---	---	---	---

- LEGEND:**
- WALL AND CEILING LEGEND:**
- AC Architectural Ceiling
  - ACT Acoustic Ceiling Tile
  - ACT-C Cleanroom
  - ARGB Abuse-Resistant Gypsum Board
  - GB Gypsum Board
  - IRGB Impact-Resistant Gypsum Board
  - KLCT Kitchen Lay-in Ceiling Tile
  - MMRGB Moisture and Mould-Resistant Gypsum Board
  - SACT Security Acoustic Ceiling Tile
- WALL FINISHES LEGEND:**
- EWC Epoxy Wall Coating
  - HPC High Performance Coating
  - PT Paint
- CEILING FINISHES LEGEND:**
- ECC Epoxy Ceiling Coating
  - HPC High Performance Coating
  - PF Prefinished
  - PT Paint
- WALL PROTECTION LEGEND:**
- ESRP Extruded Semi-Rigid PVCu Panel
  - FRL Fibre Reinforced Laminate
  - FRP Fibreglass Reinforced Plastic
  - PVV Protective Vinyl Wallcovering
  - RHIS Rigid High Impact Sheet
  - WSSP Wetwall Solid Surface Panel
  - WVV Wetroom Vinyl Wallcovering
- FLOOR FINISHES LEGEND:**
- CFS Concrete Floor Sealer
  - EFC Epoxy Floor Coating
  - PFC Polyurethane Floor Coating
  - RAF Rubber Athletic Flooring
  - RSF Rubber Sheet Flooring
  - SCF Seamless Cushioned Flooring
  - SDRF Static-Dissipative Rubber Sheet Flooring
  - SDVF Static-Dissipative Vinyl Sheet Flooring
  - VSF Vinyl Sheet Flooring
  - WSVF Wetroom Safety Vinyl Sheet Flooring
- FLOOR BASE LEGEND:**
- FCB Flash Cove Base
  - RB Rubber Base
  - SCF Seamless Cushioned Flooring

**DOORS**

Types:

Type	Qty	Size (mm)	Material	Finish	Side Lt.	Blinds	Protect.	Film	Function	Card Reader	Mag Lock	Auto Opener	Hold Open	Hinges	Accessory 1	Accessory 2	Accessory 3	Closer
C	1	915 x 2135	Solid Core	FRL	<input type="checkbox"/>	<input type="checkbox"/>	1 Low	<input type="checkbox"/>	Storeroom	<input checked="" type="checkbox"/>	<input type="checkbox"/>	<input type="checkbox"/>	<input type="checkbox"/>	Butt Hinge				Surface

**DOOR REMARKS:**

Security Grille  
 Anti-barricade strategy

**MILLWORK AND SPECIALTY CASEWORK**

**UPPER UNITS:** U1, U2, U3, U4, U5, U6, U7, U8

**LOWER UNITS:** L1, L2, L3, L4, L5, L6, L7, L8, L9, L10, L11, L12

**RECEPTION/TRANSACTION COUNTER / CARE TEAM STATION DESK:** TC1, TC2

**UTILITY SINK AND COUNTER UNIT:** UC1

**SHELF:** S1

**Storage Requirements:**

**FINISHES**

Full-height Cabinet:   
 Upper Millwork:   
 Countertop:   
 Lower Millwork:   
 Shelf:

**Remarks:**

Room P4.02 will require interior glazing with integral blinds.

## MECHANICAL REQUIREMENTS

<b>PLUMBING</b> (Quantity) Hand Hygiene Sink: <input type="text"/> Lavatory: <input type="text"/> Kitchen Sink: <input type="text"/> Seamless Kitchen Sink: <input type="text"/> Utility / Process Sink: <input type="text"/> Scrub Sink: <input type="text"/> Floor Sink: <input type="text"/> Plumbing Remarks: <div style="border: 1px solid black; height: 50px; width: 100%;"></div>	<b>Other Fixtures:</b> <input type="checkbox"/> Shower <input type="checkbox"/> Tub <input type="checkbox"/> Ice Maker <input type="checkbox"/> Water Closet <input type="checkbox"/> Instantaneous Hot Water <input type="checkbox"/> Eyewash Station <input type="checkbox"/> Eyewash/Shower Station <input type="checkbox"/> Emergency Shower <input type="checkbox"/> Flush Rim Sink <input type="checkbox"/> Floor Drain <input type="checkbox"/> Water Bottle Refill Station Other: <input type="text"/>	<b>MED / NON-MED GASES</b> (Quantity) Oxygen: <input type="text"/> Medical Air: <input type="text"/> Medical Vacuum: <input type="text"/> Nitrous Oxide: <input type="text"/> CO2: <input type="text"/> AGSS: <input type="text"/> Nitrogen: <input type="text"/> Laboratory Air: <input type="text"/> Laboratory Vacuum: <input type="text"/> Utility Compressed Air: <input type="text"/> Gas Remarks: <div style="border: 1px solid black; height: 50px; width: 100%;"></div>
---	---	--

**Appendix 1B Minimum Room Requirements**

Room Name:

Program Number(s):

1. A4.06	7. E7.01	13. K1.07	19. N3.05	25. T1.09	31. W2.05	37.	43.
2. B4.07	8. F8.01	14. L3.01	20. P4.01	26. U2.01	32. W3.02	38.	44.
3. C8.02	9. G3.04	15. M1.05	21. Q3.02	27. U3.01	33. W4.11	39.	45.
4. D7.03	10. H1.01	16. M2.06	22. R4.01	28. U5.04	34. X4.01	40.	46.
5. E2.04	11. I3.01	17. N1.04	23. S2.03	29. U6.05	35. Y3.04	41.	47.
6. Not Used	12. J5.04	18. N2.03	24. T1.06	30. W2.01	36. Y4.01	42.	48.

**ARCHITECTURAL REQUIREMENTS**

<b>WALL AND CEILING</b> Wall Material: <input type="text" value="GB"/> Finish: <input type="text" value="PT"/> Ceiling Material: <input type="text" value="ACT"/> Finish: <input type="text" value="PF"/>	<b>WALL PROTECTION</b> Type: <input type="text"/> Height: <input type="text"/> <input checked="" type="checkbox"/> Corner Guards <input type="checkbox"/> Hand Rails <input type="checkbox"/> Bed Bumper / Locator <input type="checkbox"/> Crash Rails <input checked="" type="checkbox"/> Chair Rail	<b>GLAZING</b> <input checked="" type="checkbox"/> Interior Glazing	<b>FLOORING TYPES</b> Material: <input type="text" value="VSF"/> Base: <input type="text" value="RB"/>	<b>ROOM ACCESSORIES</b> <input checked="" type="checkbox"/> Coat Hooks <input type="checkbox"/> Ceiling Lift <input checked="" type="checkbox"/> Magnetic Whiteboard <input type="checkbox"/> Mirror <input type="checkbox"/> Infant Change Table <input type="checkbox"/> Privacy Curtain
---	---	--	---	--

- LEGEND:**
- WALL AND CEILING LEGEND:**
- AC Architectural Ceiling
  - ACT Acoustic Ceiling Tile
  - ACT-C Cleanroom
  - ARGB Abuse-Resistant Gypsum Board
  - GB Gypsum Board
  - IRGB Impact-Resistant Gypsum Board
  - KLCT Kitchen Lay-in Ceiling Tile
  - MMRGB Moisture and Mould-Resistant Gypsum Board
  - SACT Security Acoustic Ceiling Tile
- WALL FINISHES LEGEND:**
- EWC Epoxy Wall Coating
  - HPC High Performance Coating
  - PT Paint
- CEILING FINISHES LEGEND:**
- ECC Epoxy Ceiling Coating
  - HPC High Performance Coating
  - PF Prefinished
  - PT Paint
- WALL PROTECTION LEGEND:**
- ESRP Extruded Semi-Rigid PVCu Panel
  - FRL Fibre Reinforced Laminate
  - FRP Fibreglass Reinforced Plastic
  - PVV Protective Vinyl Wallcovering
  - RHIS Rigid High Impact Sheet
  - WSSP Wetwall Solid Surface Panel
  - WVV Wetroom Vinyl Wallcovering
- FLOOR FINISHES LEGEND:**
- CFS Concrete Floor Sealer
  - EFC Epoxy Floor Coating
  - PFC Polyurethane Floor Coating
  - RAF Rubber Athletic Flooring
  - RSF Rubber Sheet Flooring
  - SCF Seamless Cushioned Flooring
  - SDRF Static-Dissipative Rubber Sheet Flooring
  - SDVF Static-Dissipative Vinyl Sheet Flooring
  - VSF Vinyl Sheet Flooring
  - WSVF Wetroom Safety Vinyl Sheet Flooring
- FLOOR BASE LEGEND:**
- FCB Flash Cove Base
  - RB Rubber Base
  - SCF Seamless Cushioned Flooring

**DOORS**

Types:

Type	Qty	Size (mm)	Material	Finish	Side Lt.	Blinds	Protect.	Privacy Film	Function	Card Reader	Mag Lock	Auto Opener	Hold Open	Hinges	Accessory 1	Accessory 2	Accessory 3	Closer
C	1	915 x 2135	Solid Core	FRL	<input checked="" type="checkbox"/>	<input type="checkbox"/>	1 Low	<input type="checkbox"/>	Storeroom	<input checked="" type="checkbox"/>	<input type="checkbox"/>	<input type="checkbox"/>	<input type="checkbox"/>	Butt Hinge				Surface

Door Remarks:

Security Grille  
 Anti-barricade strategy

**MILLWORK AND SPECIALTY CASEWORK**

**UPPER UNITS** (U1-U8) **LOWER UNITS** (L1-L12) **RECEPTION/TRANSACTION COUNTER / CARE TEAM STATION DESK** (TC1-TC2) **UTILITY SINK AND COUNTER UNIT** (UC1)

Storage Requirements:

**FINISHES**

Full-height Cabinet:   
 Upper Millwork:   
 Countertop:   
 Lower Millwork:   
 Shelf:

Remarks:

**Legend:**

Category	Min. Length (mm)	Motorized Adjustable Height	Standing Height	Specialty Casework
Category 0 - None		<input type="checkbox"/>	<input type="checkbox"/>	<input type="checkbox"/>
Category 1 - Low (1% - 4%)		<input type="checkbox"/>	<input type="checkbox"/>	<input type="checkbox"/>
Category 2 - Med (5% - 9%)		<input type="checkbox"/>	<input type="checkbox"/>	<input type="checkbox"/>
Category 3 - High (10% or Greater)		<input type="checkbox"/>	<input type="checkbox"/>	<input type="checkbox"/>

**MECHANICAL REQUIREMENTS**

<b>PLUMBING</b> (Quantity) Hygiene Sink: <input type="text"/> Lavatory: <input type="text"/> Kitchen Sink: <input type="text"/> Seamless Kitchen Sink: <input type="text"/> Utility / Process Sink: <input type="text"/> Scrub Sink: <input type="text"/> Floor Sink: <input type="text"/> Plumbing Remarks: <input type="text"/>	Other Fixtures: <input type="checkbox"/> Shower <input type="checkbox"/> Tub <input type="checkbox"/> Ice Maker <input type="checkbox"/> Water Closet <input type="checkbox"/> Instantaneous Hot Water <input type="checkbox"/> Eyewash Station <input type="checkbox"/> Eyewash/Shower Station <input type="checkbox"/> Emergency Shower <input type="checkbox"/> Flush Rim Sink <input type="checkbox"/> Floor Drain <input type="checkbox"/> Water Bottle Refill Station Other: <input type="text"/>	<b>MED / NON-MED GASES</b> (Quantity) Oxygen: <input type="text"/> Medical Air: <input type="text"/> Medical Vacuum: <input type="text"/> Nitrous Oxide: <input type="text"/> CO2: <input type="text"/> AGSS: <input type="text"/> Nitrogen: <input type="text"/> Laboratory Air: <input type="text"/> Laboratory Vacuum: <input type="text"/> Utility Compressed Air: <input type="text"/> Gas Remarks: <input type="text"/>
---	--	---



**Appendix 1B Minimum Room Requirements**

Room Name:

Program Number(s):

1. A3.16	7. D2.19	13. F8.04	19. R4.02	25. W4.24	31.	37.	43.
2. B2.25	8. D7.04	14. G3.03	20. U4.01	26. W5.02	32.	38.	44.
3. B3.25	9. F2.03	15. L3.02	21. U4.03	27. W5.03	33.	39.	45.
4. B4.08	10. F7.07	16. N3.06	22. U5.05	28. X4.02	34.	40.	46.
5. C8.03	11. F8.02	17. P2.06	23. U6.06	29. Y3.05	35.	41.	47.
6. D2.18	12. F8.03	18. Q3.01	24. W1.10	30.	36.	42.	48.

**ARCHITECTURAL REQUIREMENTS**

<b>WALL AND CEILING</b> Wall Material: <input type="text" value="GB"/> Finish: <input type="text" value="PT"/> Ceiling Material: <input type="text" value="ACT"/> Finish: <input type="text" value="PF"/>	<b>WALL PROTECTION</b> Type: <input type="text"/> Height: <input type="text"/> <input checked="" type="checkbox"/> Corner Guards <input type="checkbox"/> Hand Rails <input type="checkbox"/> Bed Bumper / Locator <input type="checkbox"/> Crash Rails <input checked="" type="checkbox"/> Chair Rail	<b>GLAZING</b> <input checked="" type="checkbox"/> Interior Glazing	<b>FLOORING TYPES</b> Material: <input type="text" value="VSF"/> Base: <input type="text" value="RB"/>	<b>ROOM ACCESSORIES</b> <input checked="" type="checkbox"/> Coat Hooks <input type="checkbox"/> Ceiling Lift <input checked="" type="checkbox"/> Magnetic Whiteboard <input type="checkbox"/> Mirror <input type="checkbox"/> Infant Change Table <input type="checkbox"/> Privacy Curtain
---	---	--	---	--

- LEGEND:**
- WALL AND CEILING LEGEND:**
- AC Architectural Ceiling
  - ACT Acoustic Ceiling Tile
  - ACT-C Cleanroom
  - ARGB Abuse-Resistant Gypsum Board
  - GB Gypsum Board
  - IRGB Impact-Resistant Gypsum Board
  - KLCT Kitchen Lay-in Ceiling Tile
  - MMRGB Moisture and Mould-Resistant Gypsum Board
  - SACT Security Acoustic Ceiling Tile
- WALL FINISHES LEGEND:**
- EWC Epoxy Wall Coating
  - HPC High Performance Coating
  - PT Paint
- CEILING FINISHES LEGEND:**
- ECC Epoxy Ceiling Coating
  - HPC High Performance Coating
  - PF Prefinished
  - PT Paint
- WALL PROTECTION LEGEND:**
- ESRP Extruded Semi-Rigid PVCu Panel
  - FRL Fibre Reinforced Laminate
  - FRP Fibreglass Reinforced Plastic
  - PVV Protective Vinyl Wallcovering
  - RHIS Rigid High Impact Sheet
  - WSSP Wetwall Solid Surface Panel
  - WVV Wetroom Vinyl Wallcovering
- FLOOR FINISHES LEGEND:**
- CFS Concrete Floor Sealer
  - EFC Epoxy Floor Coating
  - PFC Polyurethane Floor Coating
  - RAF Rubber Athletic Flooring
  - RSF Rubber Sheet Flooring
  - SCF Seamless Cushioned Flooring
  - SDRF Static-Dissipative Rubber Sheet Flooring
  - SDVF Static-Dissipative Vinyl Sheet Flooring
  - VSF Vinyl Sheet Flooring
  - WSVF Wetroom Safety Vinyl Sheet Flooring
- FLOOR BASE LEGEND:**
- FCB Flash Cove Base
  - RB Rubber Base
  - SCF Seamless Cushioned Flooring

**DOORS**

Types:

Integral Door & Frame Privacy Card Mag Auto Hold  
Blinds: Protect.: Film: Function: Reader: Lock: Opener: Open: Hinges: Accessory 1: Accessory 2: Accessory 3: Closer:

C	1	915 x 2135	Solid Core	FRL	<input checked="" type="checkbox"/>	<input type="checkbox"/>	1 Low	<input type="checkbox"/>	Storeroom	<input checked="" type="checkbox"/>	<input type="checkbox"/>	<input type="checkbox"/>	<input type="checkbox"/>	Butt Hinge				Surface
---	---	------------	------------	-----	-------------------------------------	--------------------------	-------	--------------------------	-----------	-------------------------------------	--------------------------	--------------------------	--------------------------	------------	--	--	--	---------

Door Remarks:

Security Grille  
 Anti-barricade strategy

**MILLWORK AND SPECIALTY CASEWORK**

Storage Requirements:

**UPPER UNITS** U1 U2 U3 U4 U5 U6 U7 U8

**LOWER UNITS** L1 L2 L3 L4 L5 L6 L7 L8 L9 L10 L11 L12

**RECEPTION/TRANSACTION COUNTER / CARE TEAM STATION DESK** TC1 TC2

**UTILITY SINK AND COUNTER UNIT** UC1

**SHELF** S1

**FULL-HEIGHT CABINETS** C1 C2 C3 C4 C5

**Legend:**  
 Category 0 - None  
 Category 1 - Low (1% - 4%)  
 Category 2 - Med (5% - 9%)  
 Category 3 - High (10% or Greater)

Category	Min. Length (mm)	Motorized Adjustable Height	Standing Height	Specialty Casework
<input type="checkbox"/>	<input type="checkbox"/>	<input type="checkbox"/>	<input type="checkbox"/>	<input type="checkbox"/>

**FINISHES**

Full-height Cabinet:   
 Upper Millwork:   
 Countertop:   
 Lower Millwork:   
 Shelf:

Remarks:

**MECHANICAL REQUIREMENTS**

**PLUMBING** (Quantity)

Hygiene Sink:	Lavatory:	Kitchen Sink:	Seamless Kitchen Sink:	Utility / Process Sink:	Scrub Sink:	Floor Sink:
<input type="text"/>	<input type="text"/>	<input type="text"/>	<input type="text"/>	<input type="text"/>	<input type="text"/>	<input type="text"/>

Plumbing Remarks:

**Other Fixtures:**

- Shower
- Tub
- Ice Maker
- Water Closet
- Instantaneous Hot Water
- Eyewash Station
- Eyewash/Shower Station
- Emergency Shower
- Flush Rim Sink
- Floor Drain
- Water Bottle Refill Station

Other:

**MED / NON-MED GASES** (Quantity)

Oxygen:	Medical Air:	Medical Vacuum:	Nitrous Oxide:	CO2:	AGSS:	Nitrogen:	Laboratory Air:	Laboratory Vacuum:	Utility Compressed Air:
<input type="text"/>	<input type="text"/>	<input type="text"/>	<input type="text"/>	<input type="text"/>	<input type="text"/>	<input type="text"/>	<input type="text"/>	<input type="text"/>	<input type="text"/>

Gas Remarks:

# Appendix 1B Minimum Room Requirements

Room Name:

Program Number(s):

1. C8.04	7.	13.	19.	25.	31.	37.	43.
2. Y2.03	8.	14.	20.	26.	32.	38.	44.
3. Y3.03	9.	15.	21.	27.	33.	39.	45.
4.	10.	16.	22.	28.	34.	40.	46.
5.	11.	17.	23.	29.	35.	41.	47.
6.	12.	18.	24.	30.	36.	42.	48.

## ARCHITECTURAL REQUIREMENTS

<b>WALL AND CEILING</b> Wall Material: <input type="text" value="GB"/> Finish: <input type="text" value="PT"/> Ceiling Material: <input type="text" value="ACT"/> Finish: <input type="text" value="PF"/>		<b>WALL PROTECTION</b> Type: <input type="text"/> Height: <input type="text"/> <input type="checkbox"/> Corner Guards <input type="checkbox"/> Hand Rails <input type="checkbox"/> Bed Bumper / Locator <input type="checkbox"/> Crash Rails <input type="checkbox"/> Chair Rail		<b>GLAZING</b> <input type="checkbox"/> Interior Glazing		<b>FLOORING TYPES</b> Material: <input type="text" value="VSF"/> Base: <input type="text" value="FCB"/>		<b>ROOM ACCESSORIES</b> <input checked="" type="checkbox"/> Coat Hooks <input type="checkbox"/> Ceiling Lift <input checked="" type="checkbox"/> Magnetic Whiteboard <input checked="" type="checkbox"/> Mirror <input type="checkbox"/> Infant Change Table <input type="checkbox"/> Privacy Curtain	
---	--	---	--	---	--	--	--	---	--

- LEGEND:**
- WALL AND CEILING LEGEND:**
- AC Architectural Ceiling
  - ACT Acoustic Ceiling Tile
  - ACT-C Cleanroom
  - ARGB Abuse-Resistant Gypsum Board
  - GB Gypsum Board
  - IRGB Impact-Resistant Gypsum Board
  - KLCT Kitchen Lay-in Ceiling Tile
  - MMRGB Moisture and Mould-Resistant Gypsum Board
  - SACT Security Acoustic Ceiling Tile
- WALL FINISHES LEGEND:**
- EWC Epoxy Wall Coating
  - HPC High Performance Coating
  - PT Paint
- CEILING FINISHES LEGEND:**
- ECC Epoxy Ceiling Coating
  - HPC High Performance Coating
  - PF Prefinished
  - PT Paint
- WALL PROTECTION LEGEND:**
- ESRP Extruded Semi-Rigid PVCu Panel
  - FRL Fibre Reinforced Laminate
  - FRP Fibreglass Reinforced Plastic
  - PVV Protective Vinyl Wallcovering
  - RHIS Rigid High Impact Sheet
  - WSSP Wetwall Solid Surface Panel
  - WVV Wetroom Vinyl Wallcovering
- FLOOR FINISHES LEGEND:**
- CFS Concrete Floor Sealer
  - EFC Epoxy Floor Coating
  - PFC Polyurethane Floor Coating
  - RAF Rubber Athletic Flooring
  - RSF Rubber Sheet Flooring
  - SCF Seamless Cushioned Flooring
  - SDRF Static-Dissipative Rubber Sheet Flooring
  - SDVF Static-Dissipative Vinyl Sheet Flooring
  - VSF Vinyl Sheet Flooring
  - WSVF Wetroom Safety Vinyl Sheet Flooring
- FLOOR BASE LEGEND:**
- FCB Flash Cove Base
  - RB Rubber Base
  - SCF Seamless Cushioned Flooring

**DOORS**

Types:

Type	Qty	Size (mm)	Material	Finish	Side Lt.	Blinds	Protect.	Film	Function	Card Reader	Mag Lock	Auto Opener	Hold Open	Hinges	Accessory 1	Accessory 2	Accessory 3	Closer
A	1	915 x 2135	Solid Core	FRL	<input type="checkbox"/>	<input type="checkbox"/>	1 Low	<input type="checkbox"/>	Other Deadbolt	<input checked="" type="checkbox"/>	<input type="checkbox"/>	<input type="checkbox"/>	<input type="checkbox"/>	Butt Hinge				Surface

**Door Remarks:**  
 Comply with Appendix 1T [UBC FoM Design Guidelines and Functional Requirements]. Provide deadbolt with privacy indicator.

Security Grille  
 Anti-barricade strategy

**MILLWORK AND SPECIALTY CASEWORK**

Storage Requirements: Provide a secured purse locker sized to accommodate a laptop

**UPPER UNITS:** U1, U2, U3, U4, U5, U6, U7, U8

**LOWER UNITS:** L1, L2, L3, L4, L5, L6, L7, L8, L9, L10, L11, L12

**RECEPTION/TRANSACTION COUNTER / CARE TEAM STATION DESK:** TC1, TC2

**UTILITY SINK AND COUNTER UNIT:** UC1

**SHELF:** S1

**FULL-HEIGHT CABINETS:** C1, C2, C3, C4, C5

**Legend:**  
 Category 0 - None  
 Category 1 - Low (1% - 4%)  
 Category 2 - Med (5% - 9%)  
 Category 3 - High (10% or Greater)

Category	Min. Length (mm)	Motorized Adjustable Height	Standing Height	Specialty Casework
		<input type="checkbox"/>	<input type="checkbox"/>	<input type="checkbox"/>

**FINISHES**

Full-height Cabinet:   
 Upper Millwork:   
 Countertop:   
 Lower Millwork:   
 Shelf:

**Remarks:**  
 Provide a full height mirror.

## MECHANICAL REQUIREMENTS

**PLUMBING**

Hand Hygiene Sink:	Lavatory:	Kitchen Sink:	Seamless Kitchen Sink:	Utility / Process Sink:	Scrub Sink:	Floor Sink:
<input type="text"/>	<input type="text"/>	<input type="text"/>	<input type="text"/>	<input type="text"/>	<input type="text"/>	<input type="text"/>

Plumbing Remarks:

**Other Fixtures:**

- Shower
- Tub
- Ice Maker
- Water Closet
- Instantaneous Hot Water
- Eyewash Station
- Eyewash/Shower Station
- Emergency Shower
- Flush Rim Sink
- Floor Drain
- Water Bottle Refill Station

Other:

**MED / NON-MED GASES**

Oxygen:	Medical Air:	Medical Vacuum:	Nitrous Oxide:	CO2:	AGSS:	Nitrogen:	Laboratory Air:	Laboratory Vacuum:	Utility Compressed Air:
<input type="text"/>	<input type="text"/>	<input type="text"/>	<input type="text"/>	<input type="text"/>	<input type="text"/>	<input type="text"/>	<input type="text"/>	<input type="text"/>	<input type="text"/>

Gas Remarks:

**Appendix 1B Minimum Room Requirements**

Room Name:

Program Number(s):

1. A1.01	7. I1.01	13.	19.	25.	31.	37.	43.
2. D1.01	8. L1.02	14.	20.	26.	32.	38.	44.
3. E8.01	9. M2.02	15.	21.	27.	33.	39.	45.
4. F1.01	10.	16.	22.	28.	34.	40.	46.
5. F2.02	11.	17.	23.	29.	35.	41.	47.
6. G1.02	12.	18.	24.	30.	36.	42.	48.

**ARCHITECTURAL REQUIREMENTS**

<b>WALL AND CEILING</b> Wall Material: <input type="text" value="ARGB 1.2m AFF, GB above"/> Finish: <input type="text" value="PT"/> Ceiling Material: <input type="text" value="ACT"/> Finish: <input type="text" value="PF"/>		<b>WALL PROTECTION</b> Type: <input type="text" value="FRP"/> <input type="checkbox"/> Corner Guards <input type="checkbox"/> Hand Rails <input type="checkbox"/> Bed Bumper / Locator Height: <input type="text" value="1350 mm"/> <input type="checkbox"/> Crash Rails <input checked="" type="checkbox"/> Chair Rail			<b>GLAZING</b> <input checked="" type="checkbox"/> Interior Glazing		<b>FLOORING TYPES</b> Material: <input type="text" value="VSF"/> Base: <input type="text" value="FCB"/>		<b>ROOM ACCESSORIES</b> <input type="checkbox"/> Coat Hooks <input type="checkbox"/> Ceiling Lift <input type="checkbox"/> Magnetic Whiteboard <input type="checkbox"/> Mirror <input type="checkbox"/> Infant Change Table <input type="checkbox"/> Privacy Curtain		
--	--	---	--	--	--	--	--	--	--	--	--

- LEGEND:**
- WALL AND CEILING LEGEND:**
- AC Architectural Ceiling
  - ACT Acoustic Ceiling Tile
  - ACT-C Cleanroom
  - ARGB Abuse-Resistant Gypsum Board
  - GB Gypsum Board
  - IRGB Impact-Resistant Gypsum Board
  - KLCT Kitchen Lay-in Ceiling Tile
  - MMRGB Moisture and Mould-Resistant Gypsum Board
  - SACT Security Acoustic Ceiling Tile
- WALL FINISHES LEGEND:**
- EWC Epoxy Wall Coating
  - HPC High Performance Coating
  - PT Paint
- CEILING FINISHES LEGEND:**
- ECC Epoxy Ceiling Coating
  - HPC High Performance Coating
  - PF Prefinished
  - PT Paint
- WALL PROTECTION LEGEND:**
- ESRP Extruded Semi-Rigid PVCu Panel
  - FRL Fibre Reinforced Laminate
  - FRP Fibreglass Reinforced Plastic
  - PVV Protective Vinyl Wallcovering
  - RHIS Rigid High Impact Sheet
  - WSSP Wetwall Solid Surface Panel
  - WVV Wetroom Vinyl Wallcovering
- FLOOR FINISHES LEGEND:**
- CFS Concrete Floor Sealer
  - EFC Epoxy Floor Coating
  - PFC Polyurethane Floor Coating
  - RAF Rubber Athletic Flooring
  - RSF Rubber Sheet Flooring
  - SCF Seamless Cushioned Flooring
  - SDRF Static-Dissipative Rubber Sheet Flooring
  - SDVF Static-Dissipative Vinyl Sheet Flooring
  - VSF Vinyl Sheet Flooring
  - WSVF Wetroom Safety Vinyl Sheet Flooring
- FLOOR BASE LEGEND:**
- FCB Flash Cove Base
  - RB Rubber Base
  - SCF Seamless Cushioned Flooring

**DOORS**

Types:

Type	Qty	Size (mm)	Material	Finish	Side Lt.	Blinds	Protect.	Film	Function	Card Reader	Mag Lock	Auto Opener	Hold Open	Hinges	Accessory 1	Accessory 2	Accessory 3	Closer
C	2	915 x 2135	Solid Core	FRL	<input type="checkbox"/>	<input type="checkbox"/>	1 Low	<input type="checkbox"/>	Storeroom	<input checked="" type="checkbox"/>	<input type="checkbox"/>	<input type="checkbox"/>	<input type="checkbox"/>	Butt Hinge				Concealed

Door Remarks:  Security Grille  Anti-barricade strategy

**MILLWORK AND SPECIALTY CASEWORK**

Storage Requirements:

**UPPER UNITS** (U1-U8)

**LOWER UNITS** (L1-L12)

**RECEPTION/TRANSACTION COUNTER / CARE TEAM STATION DESK** (TC1, TC2)

**UTILITY SINK AND COUNTER UNIT** (UC1)

**SHELF** (S1)

**FULL-HEIGHT CABINETS** (C1-C5)

**Legend:**

Category	Min. Length (mm)	Motorized Adjustable Height	Standing Height	Specialty Casework
3	3600	<input type="checkbox"/>	<input type="checkbox"/>	<input type="checkbox"/>

**FINISHES**

- Full-height Cabinet:
- Upper Millwork:
- Countertop:
- Lower Millwork:
- Shelf:

Remarks: Refer to Appendix 1A, Section 3.1 Recurring Rooms for Patient Check-In requirements

**MECHANICAL REQUIREMENTS**

<b>PLUMBING</b> (Quantity) Hand Hygiene Sink: <input type="text"/> Lavatory: <input type="text"/> Kitchen Sink: <input type="text"/> Seamless Kitchen Sink: <input type="text"/> Utility / Process Sink: <input type="text"/> Scrub Sink: <input type="text"/> Floor Sink: <input type="text"/>							Other Fixtures: <input type="checkbox"/> Shower <input type="checkbox"/> Eyewash Station <input type="checkbox"/> Tub <input type="checkbox"/> Eyewash/Shower Station <input type="checkbox"/> Ice Maker <input type="checkbox"/> Emergency Shower <input type="checkbox"/> Water Closet <input type="checkbox"/> Flush Rim Sink <input type="checkbox"/> Instantaneous Hot Water <input type="checkbox"/> Floor Drain <input type="checkbox"/> <input type="checkbox"/> Water Bottle Refill Station Other <input type="text"/>				<b>MED / NON-MED GASES</b> (Quantity) Oxygen: <input type="text"/> Medical Air: <input type="text"/> Medical Vacuum: <input type="text"/> Nitrous Oxide: <input type="text"/> CO2: <input type="text"/> AGSS: <input type="text"/> Nitrogen: <input type="text"/> Laboratory Air: <input type="text"/> Laboratory Vacuum: <input type="text"/> Utility Compressed Air: <input type="text"/>					
Plumbing Remarks: <input type="text"/>											Gas Remarks: <input type="text"/>					



**Appendix 1B Minimum Room Requirements**

Room Name:

Program Number(s):

1. B1.04	7.	13.	19.	25.	31.	37.	43.
2. B2.05	8.	14.	20.	26.	32.	38.	44.
3.	9.	15.	21.	27.	33.	39.	45.
4.	10.	16.	22.	28.	34.	40.	46.
5.	11.	17.	23.	29.	35.	41.	47.
6.	12.	18.	24.	30.	36.	42.	48.

**ARCHITECTURAL REQUIREMENTS**

<b>WALL AND CEILING</b> Wall Material: <input type="text" value="ARGB 1.2m AFF, GB above"/> Finish: <input type="text" value="PT"/> Ceiling Material: <input type="text" value="GB"/> Finish: <input type="text" value="ECC"/>		<b>WALL PROTECTION</b> Type: <input type="text" value="PVW"/> <input checked="" type="checkbox"/> Corner Guards <input type="checkbox"/> Hand Rails <input checked="" type="checkbox"/> Bed Bumper / Locator Height: <input type="text" value="1350 mm"/> <input type="checkbox"/> Crash Rails <input type="checkbox"/> Chair Rail		<b>GLAZING</b> <input checked="" type="checkbox"/> Interior Glazing		<b>FLOORING TYPES</b> Material: <input type="text" value="VSF"/> Base: <input type="text" value="FCB"/>		<b>ROOM ACCESSORIES</b> <input checked="" type="checkbox"/> Coat Hooks <input checked="" type="checkbox"/> Ceiling Lift <input checked="" type="checkbox"/> Magnetic Whiteboard <input type="checkbox"/> Mirror <input type="checkbox"/> Infant Change Table <input checked="" type="checkbox"/> Privacy Curtain	
--	--	--	--	--	--	--	--	--	--

- LEGEND:**
- WALL AND CEILING LEGEND:**
- AC Architectural Ceiling
  - ACT Acoustic Ceiling Tile
  - ACT-C Cleanroom
  - ARGB Abuse-Resistant Gypsum Board
  - GB Gypsum Board
  - IRGB Impact-Resistant Gypsum Board
  - KLCT Kitchen Lay-in Ceiling Tile
  - MMRGB Moisture and Mould-Resistant Gypsum Board
  - SACT Security Acoustic Ceiling Tile
- WALL FINISHES LEGEND:**
- EWC Epoxy Wall Coating
  - HPC High Performance Coating
  - PT Paint
- CEILING FINISHES LEGEND:**
- ECC Epoxy Ceiling Coating
  - HPC High Performance Coating
  - PF Prefinished
  - PT Paint
- WALL PROTECTION LEGEND:**
- ESRP Extruded Semi-Rigid PVCu Panel
  - FRL Fibre Reinforced Laminate
  - FRP Fibreglass Reinforced Plastic
  - PVW Protective Vinyl Wallcovering
  - RHIS Rigid High Impact Sheet
  - WSSP Wetwall Solid Surface Panel
  - WVV Wetroom Vinyl Wallcovering
- FLOOR FINISHES LEGEND:**
- CFS Concrete Floor Sealer
  - EFC Epoxy Floor Coating
  - PFC Polyurethane Floor Coating
  - RAF Rubber Athletic Flooring
  - RSF Rubber Sheet Flooring
  - SCF Seamless Cushioned Flooring
  - SDRF Static-Dissipative Rubber Sheet Flooring
  - SDVF Static-Dissipative Vinyl Sheet Flooring
  - VSF Vinyl Sheet Flooring
  - WSVF Wetroom Safety Vinyl Sheet Flooring
- FLOOR BASE LEGEND:**
- FCB Flash Cove Base
  - RB Rubber Base
  - SCF Seamless Cushioned Flooring

**DOORS**

Types:

Note: for Type F doors, the door panels will be approximately 465/1065 unless otherwise required by the Authority

Door Remarks:  Security Grille  Anti-barricade strategy

F2 door to have a half window

Type	Qty	Size (mm)	Material	Finish	Side Lt	Blinds	Protect	Privacy Film	Function	Card Reader	Mag Lock	Auto Opener	Hold Open	Hinges	Accessory 1	Accessory 2	Accessory 3	Closer
F2	1	1530 x 2135	Solid Core	FRL	<input type="checkbox"/>	<input type="checkbox"/>	2 High	<input type="checkbox"/>	Passage	<input type="checkbox"/>	<input type="checkbox"/>	<input type="checkbox"/>	<input type="checkbox"/>	Butt Hinge	Astragal	Flush Bolt		Surface

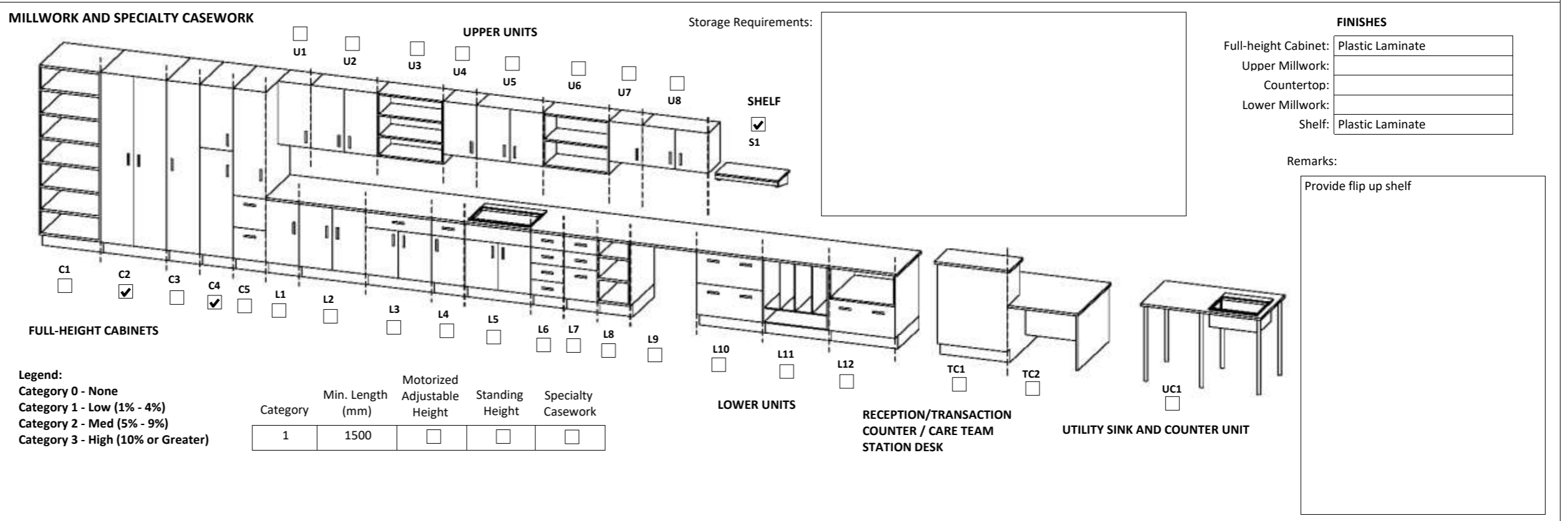

**MECHANICAL REQUIREMENTS**

<b>PLUMBING</b> (Quantity)		Hand Hygiene Sink: <input type="text" value="1"/>		Lavatory: <input type="text"/>		Kitchen Sink: <input type="text"/>		Seamless Kitchen Sink: <input type="text"/>		Utility / Process Sink: <input type="text"/>		Scrub Sink: <input type="text"/>		Floor Sink: <input type="text"/>		Other Fixtures:		<b>MED / NON-MED GASES</b> (Quantity)	
Plumbing Remarks:		<input type="checkbox"/> Shower		<input type="checkbox"/> Tub		<input type="checkbox"/> Ice Maker		<input type="checkbox"/> Water Closet		<input type="checkbox"/> Instantaneous Hot Water		<input type="checkbox"/> Eyewash Station		<input type="checkbox"/> Eyewash/Shower Station		<input type="checkbox"/> Emergency Shower		<input type="checkbox"/> Flush Rim Sink	
		<input type="checkbox"/> Floor Drain		<input type="checkbox"/> Water Bottle Refill Station		Other: <input type="text"/>		Oxygen: <input type="text" value="4"/>		Medical Air: <input type="text" value="2"/>		Medical Vacuum: <input type="text" value="4"/>		Nitrous Oxide: <input type="text"/>		CO2: <input type="text"/>		AGSS: <input type="text"/>	
		Laboratory Air: <input type="text"/>		Laboratory Vacuum: <input type="text"/>		Utility Compressed Air: <input type="text"/>		Gas Remarks: <input type="text" value="Provide medical gases on both sides of the bed ((2) O2, (1) Medical Air, (2) Medical Vacuum on each side)"/>											

# Appendix 1B Minimum Room Requirements

Room Name:

Program Number(s):

1. B3.03	7.	13.	19.	25.	31.	37.	43.
2.	8.	14.	20.	26.	32.	38.	44.
3.	9.	15.	21.	27.	33.	39.	45.
4.	10.	16.	22.	28.	34.	40.	46.
5.	11.	17.	23.	29.	35.	41.	47.
6.	12.	18.	24.	30.	36.	42.	48.

## ARCHITECTURAL REQUIREMENTS

<b>WALL AND CEILING</b> Wall Material: <input type="text" value="ARGB 1.2m AFF, GB above"/> Finish: <input type="text" value="PT"/> Ceiling Material: <input type="text" value="GB"/> Finish: <input type="text" value="ECC"/>	<b>WALL PROTECTION</b> Type: <input type="text" value="PVW"/> <input checked="" type="checkbox"/> Corner Guards <input type="checkbox"/> Hand Rails <input checked="" type="checkbox"/> Bed Bumper / Locator Height: <input type="text" value="1350 mm"/> <input type="checkbox"/> Crash Rails <input type="checkbox"/> Chair Rail	<b>GLAZING</b> <input checked="" type="checkbox"/> Interior Glazing	<b>FLOORING TYPES</b> Material: <input type="text" value="VSF"/> <input type="text" value="FCB"/>	<b>ROOM ACCESSORIES</b> <input checked="" type="checkbox"/> Coat Hooks <input checked="" type="checkbox"/> Ceiling Lift <input checked="" type="checkbox"/> Magnetic Whiteboard <input type="checkbox"/> Mirror <input type="checkbox"/> Infant Change Table <input checked="" type="checkbox"/> Privacy Curtain
--	--	--	--	--

- LEGEND:**
- WALL AND CEILING LEGEND:**
- AC Architectural Ceiling
  - ACT Acoustic Ceiling Tile
  - ACT-C Cleanroom
  - ARGB Abuse-Resistant Gypsum Board
  - GB Gypsum Board
  - IRGB Impact-Resistant Gypsum Board
  - KLCT Kitchen Lay-in Ceiling Tile
  - MMRGB Moisture and Mould-Resistant Gypsum Board
  - SACT Security Acoustic Ceiling Tile
- WALL FINISHES LEGEND:**
- EWC Epoxy Wall Coating
  - HPC High Performance Coating
  - PT Paint
- CEILING FINISHES LEGEND:**
- ECC Epoxy Ceiling Coating
  - HPC High Performance Coating
  - PF Prefinished
  - PT Paint
- WALL PROTECTION LEGEND:**
- ESRP Extruded Semi-Rigid PVCu Panel
  - FRL Fibre Reinforced Laminate
  - FRP Fibreglass Reinforced Plastic
  - PVW Protective Vinyl Wallcovering
  - RHIS Rigid High Impact Sheet
  - WSSP Wetwall Solid Surface Panel
  - WVV Wetroom Vinyl Wallcovering
- FLOOR FINISHES LEGEND:**
- CFS Concrete Floor Sealer
  - EFC Epoxy Floor Coating
  - PFC Polyurethane Floor Coating
  - RAF Rubber Athletic Flooring
  - RSF Rubber Sheet Flooring
  - SCF Seamless Cushioned Flooring
  - SDRF Static-Dissipative Rubber Sheet Flooring
  - SDVF Static-Dissipative Vinyl Sheet Flooring
  - VSF Vinyl Sheet Flooring
  - WSVF Wetroom Safety Vinyl Sheet Flooring
- FLOOR BASE LEGEND:**
- FCB Flash Cove Base
  - RB Rubber Base
  - SCF Seamless Cushioned Flooring

**DOORS**

Types:

Note: for Type F doors, the door panels will be approximately 465/1065 unless otherwise required by the Authority

Door Remarks:  Security Grille  Anti-barricade strategy

F2 door to have a half window

Type	Qty	Size (mm)	Material	Finish	Side Lt	Blinds	Protect	Privacy Film	Function	Card Reader	Mag Lock	Auto Opener	Hold Open	Hinges	Accessory 1	Accessory 2	Accessory 3	Closer
F2	1	1530 x 2135	Solid Core	FRL	<input type="checkbox"/>	<input type="checkbox"/>	2 High	<input type="checkbox"/>	Passage	<input type="checkbox"/>	<input type="checkbox"/>	<input type="checkbox"/>	<input type="checkbox"/>	Butt Hinge	Astragal	Flush Bolt		Surface

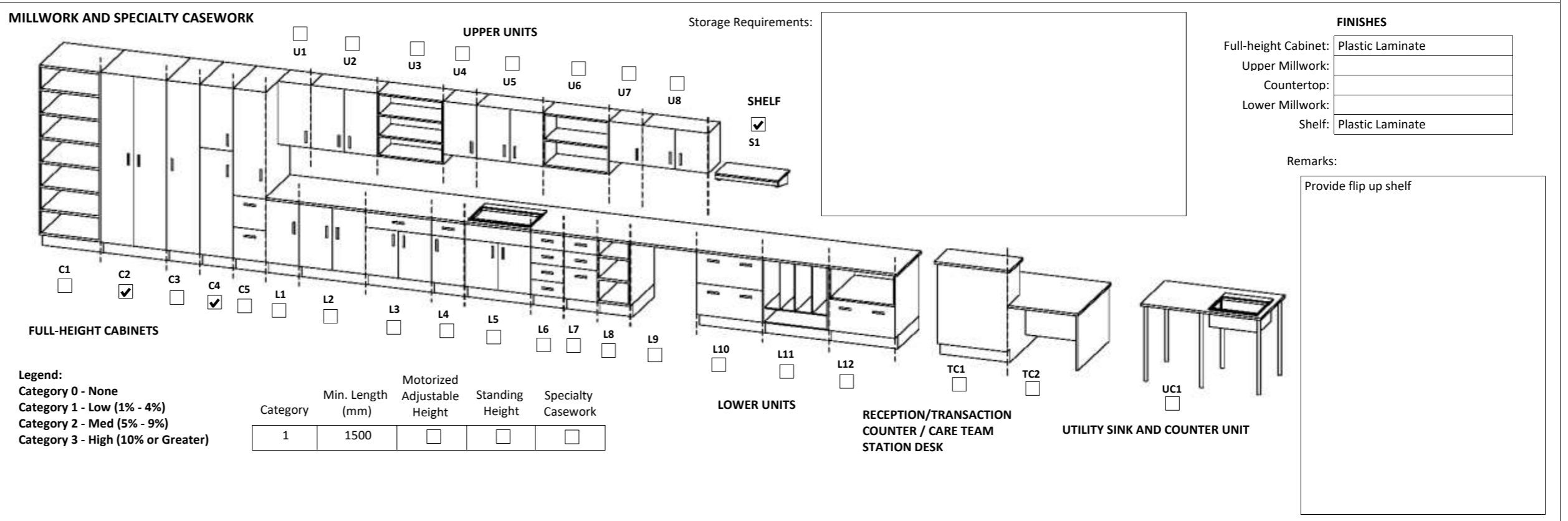

## MECHANICAL REQUIREMENTS

<b>PLUMBING</b> (Quantity) Hand Hygiene Sink: <input type="text" value="1"/> Lavatory: <input type="text"/> Kitchen Sink: <input type="text"/> Seamless Kitchen Sink: <input type="text"/> Utility / Process Sink: <input type="text"/> Scrub Sink: <input type="text"/> Floor Sink: <input type="text"/> Plumbing Remarks: <input type="text"/>	Other Fixtures: <input type="checkbox"/> Shower <input type="checkbox"/> Eyewash Station <input type="checkbox"/> Tub <input type="checkbox"/> Eyewash/Shower Station <input type="checkbox"/> Ice Maker <input type="checkbox"/> Emergency Shower <input type="checkbox"/> Water Closet <input type="checkbox"/> Flush Rim Sink <input type="checkbox"/> Instantaneous Hot Water <input type="checkbox"/> Floor Drain <input type="checkbox"/> <input type="checkbox"/> Water Bottle Refill Station Other: <input type="text"/>	<b>MED / NON-MED GASES</b> (Quantity) Oxygen: <input type="text" value="5"/> Medical Air: <input type="text" value="3"/> Medical Vacuum: <input type="text" value="5"/> Nitrous Oxide: <input type="text"/> CO2: <input type="text"/> AGSS: <input type="text"/> Nitrogen: <input type="text"/> Laboratory Air: <input type="text"/> Laboratory Vacuum: <input type="text"/> Utility Compressed Air: <input type="text"/> Gas Remarks: Provide medical gases (each boom with (2) O2, (1) Air, (2) Medical Vacuum and 1 set of wall outlets ((1) O2, (1) Medical Air, (1) Medical Vacuum) Provide boom on either side of bed ((1) nursing and (1) respiratory)
---	---	--

# Appendix 1B Minimum Room Requirements

Room Name: Patient Room - Double

Program Number(s):	1. B1.02	7.	13.	19.	25.	31.	37.	43.
	2.	8.	14.	20.	26.	32.	38.	44.
	3.	9.	15.	21.	27.	33.	39.	45.
	4.	10.	16.	22.	28.	34.	40.	46.
	5.	11.	17.	23.	29.	35.	41.	47.
	6.	12.	18.	24.	30.	36.	42.	48.

## ARCHITECTURAL REQUIREMENTS

<b>WALL AND CEILING</b> Wall Material: ARGB 1.2m AFF, GB above Ceiling Material: ACT Finish: PT Finish: PF		<b>WALL PROTECTION</b> Type: PVW Height: 1350 mm <input checked="" type="checkbox"/> Corner Guards <input type="checkbox"/> Hand Rails <input checked="" type="checkbox"/> Bed Bumper / Locator <input type="checkbox"/> Crash Rails <input type="checkbox"/> Chair Rail		<b>GLAZING</b> <input checked="" type="checkbox"/> Interior Glazing		<b>FLOORING TYPES</b> Material: VSF Base: FCB		<b>ROOM ACCESSORIES</b> <input checked="" type="checkbox"/> Coat Hooks <input type="checkbox"/> Mirror <input checked="" type="checkbox"/> Ceiling Lift <input type="checkbox"/> Infant Change Table <input checked="" type="checkbox"/> Magnetic Whiteboard <input checked="" type="checkbox"/> Privacy Curtain	
--	--	---	--	--	--	---	--	--	--

- LEGEND:**
- WALL AND CEILING LEGEND:**
- AC Architectural Ceiling
  - ACT Acoustic Ceiling Tile
  - ACT-C Cleanroom
  - ARGB Abuse-Resistant Gypsum Board
  - GB Gypsum Board
  - IRGB Impact-Resistant Gypsum Board
  - KLCT Kitchen Lay-in Ceiling Tile
  - MMRGB Moisture and Mould-Resistant Gypsum Board
  - SACT Security Acoustic Ceiling Tile
- WALL FINISHES LEGEND:**
- EWC Epoxy Wall Coating
  - HPC High Performance Coating
  - PT Paint
- CEILING FINISHES LEGEND:**
- ECC Epoxy Ceiling Coating
  - HPC High Performance Coating
  - PF Prefinished
  - PT Paint
- WALL PROTECTION LEGEND:**
- ESRP Extruded Semi-Rigid PVCu Panel
  - FRL Fibre Reinforced Laminate
  - FRP Fibreglass Reinforced Plastic
  - PVW Protective Vinyl Wallcovering
  - RHIS Rigid High Impact Sheet
  - WSSP Wetwall Solid Surface Panel
  - WVV Wetroom Vinyl Wallcovering
- FLOOR FINISHES LEGEND:**
- CFS Concrete Floor Sealer
  - EFC Epoxy Floor Coating
  - PFC Polyurethane Floor Coating
  - RAF Rubber Athletic Flooring
  - RSF Rubber Sheet Flooring
  - SCF Seamless Cushioned Flooring
  - SDRF Static-Dissipative Rubber Sheet Flooring
  - SDVF Static-Dissipative Vinyl Sheet Flooring
  - VSF Vinyl Sheet Flooring
  - WSVF Wetroom Safety Vinyl Sheet Flooring
- FLOOR BASE LEGEND:**
- FCB Flash Cove Base
  - RB Rubber Base
  - SCF Seamless Cushioned Flooring

**DOORS**

Types:

Note: for Type F doors, the door panels will be approximately 465/1065 unless otherwise required by the Authority

Door Remarks: F2 door to have a half window

Security Grille  
 Anti-barricade strategy

Type	Qty	Size (mm)	Material	Finish	Side Lt	Blinds	Protect	Privacy Film	Function	Card Reader	Mag Lock	Auto Opener	Hold Open	Hinges	Accessory 1	Accessory 2	Accessory 3	Closer
F2	1	1530 x 2135	Solid Core	FRL	<input type="checkbox"/>	<input checked="" type="checkbox"/>	2 High	<input type="checkbox"/>	Passage	<input type="checkbox"/>	<input type="checkbox"/>	<input type="checkbox"/>	<input type="checkbox"/>	Butt Hinge	Astragal	Flush Bolt		Surface

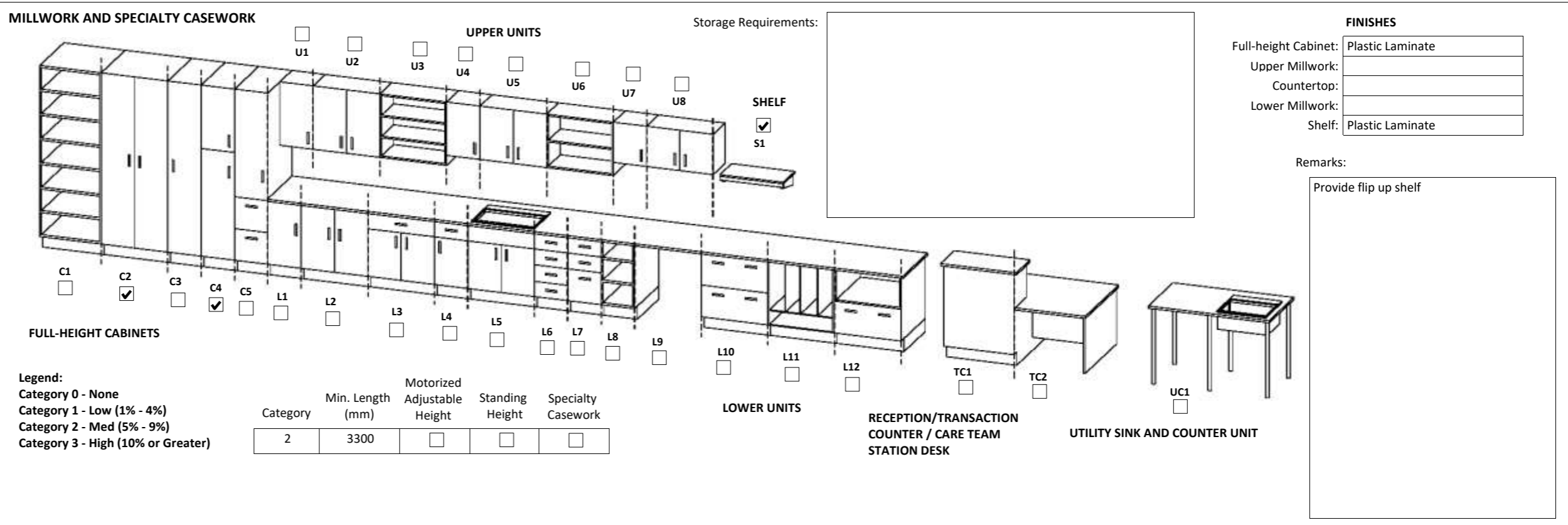

## MECHANICAL REQUIREMENTS

**PLUMBING**

Hand Hygiene Sink:	Laundry:	Kitchen Sink:	Seamless Kitchen Sink:	Utility / Process Sink:	Scrub Sink:	Floor Sink:
1						

Plumbing Remarks:

**Other Fixtures:**

- Shower
- Tub
- Ice Maker
- Water Closet
- Instantaneous Hot Water
- Eyewash Station
- Eyewash/Shower Station
- Emergency Shower
- Flush Rim Sink
- Floor Drain
- Water Bottle Refill Station

Other:

**MED / NON-MED GASES**

Oxygen:	Medical Air:	Medical Vacuum:	Nitrous Oxide:	CO2:	AGSS:	Nitrogen:	Laboratory Air:	Laboratory Vacuum:	Utility Compressed Air:
8	4	8							

Gas Remarks: Each bed to provide medical gases on both sides of the bed ((2) O2, (1) Medical Air, (2) Medical Vacuum on each side)



**Appendix 1B Minimum Room Requirements**

Room Name:

Program Number(s):

1. B3.01	7.	13.	19.	25.	31.	37.	43.
2.	8.	14.	20.	26.	32.	38.	44.
3.	9.	15.	21.	27.	33.	39.	45.
4.	10.	16.	22.	28.	34.	40.	46.
5.	11.	17.	23.	29.	35.	41.	47.
6.	12.	18.	24.	30.	36.	42.	48.

**ARCHITECTURAL REQUIREMENTS**

<b>WALL AND CEILING</b> Wall Material: <input type="text" value="ARGB 1.2m AFF, GB above"/> Finish: <input type="text" value="PT"/> Ceiling Material: <input type="text" value="ACT"/> Finish: <input type="text" value="PF"/>	<b>WALL PROTECTION</b> Type: <input type="text" value="PVW"/> <input checked="" type="checkbox"/> Corner Guards <input type="checkbox"/> Hand Rails <input checked="" type="checkbox"/> Bed Bumper / Locator Height: <input type="text" value="1350 mm"/> <input type="checkbox"/> Crash Rails <input type="checkbox"/> Chair Rail	<b>GLAZING</b> <input checked="" type="checkbox"/> Interior Glazing	<b>FLOORING TYPES</b> Material: <input type="text" value="VSF"/> Base: <input type="text" value="FCB"/>	<b>ROOM ACCESSORIES</b> <input checked="" type="checkbox"/> Coat Hooks <input checked="" type="checkbox"/> Ceiling Lift <input checked="" type="checkbox"/> Magnetic Whiteboard <input type="checkbox"/> Mirror <input type="checkbox"/> Infant Change Table <input checked="" type="checkbox"/> Privacy Curtain
--	--	--	--	--

- LEGEND:**
- WALL AND CEILING LEGEND:**
- AC Architectural Ceiling
  - ACT Acoustic Ceiling Tile
  - ACT-C Cleanroom
  - ARGB Abuse-Resistant Gypsum Board
  - GB Gypsum Board
  - IRGB Impact-Resistant Gypsum Board
  - KLCT Kitchen Lay-in Ceiling Tile
  - MMRGB Moisture and Mould-Resistant Gypsum Board
  - SACT Security Acoustic Ceiling Tile
- WALL FINISHES LEGEND:**
- EWC Epoxy Wall Coating
  - HPC High Performance Coating
  - PT Paint
- CEILING FINISHES LEGEND:**
- ECC Epoxy Ceiling Coating
  - HPC High Performance Coating
  - PF Prefinished
  - PT Paint
- WALL PROTECTION LEGEND:**
- ESRP Extruded Semi-Rigid PVCu Panel
  - FRL Fibre Reinforced Laminate
  - FRP Fibreglass Reinforced Plastic
  - PVW Protective Vinyl Wallcovering
  - RHIS Rigid High Impact Sheet
  - WSSP Wetwall Solid Surface Panel
  - WVV Wetroom Vinyl Wallcovering
- FLOOR FINISHES LEGEND:**
- CFS Concrete Floor Sealer
  - EFC Epoxy Floor Coating
  - PFC Polyurethane Floor Coating
  - RAF Rubber Athletic Flooring
  - RSF Rubber Sheet Flooring
  - SCF Seamless Cushioned Flooring
  - SDRF Static-Dissipative Rubber Sheet Flooring
  - SDVF Static-Dissipative Vinyl Sheet Flooring
  - VSF Vinyl Sheet Flooring
  - WSVF Wetroom Safety Vinyl Sheet Flooring
- FLOOR BASE LEGEND:**
- FCB Flash Cove Base
  - RB Rubber Base
  - SCF Seamless Cushioned Flooring

**DOORS**

Types:

Type	Qty	Size (mm)	Material	Finish	Side Lt.	Blinds	Protect.	Privacy Film	Function	Card Reader	Mag Lock	Auto Opener	Hold Open	Hinges	Accessory 1	Accessory 2	Accessory 3	Closer
H	1	1340 x 2135	Aluminum	Prefinished	<input type="checkbox"/>	<input type="checkbox"/>	<input type="checkbox"/>	<input type="checkbox"/>		<input type="checkbox"/>	<input type="checkbox"/>	<input type="checkbox"/>	<input type="checkbox"/>					

Door Remarks:  Security Grille  Anti-barricade strategy

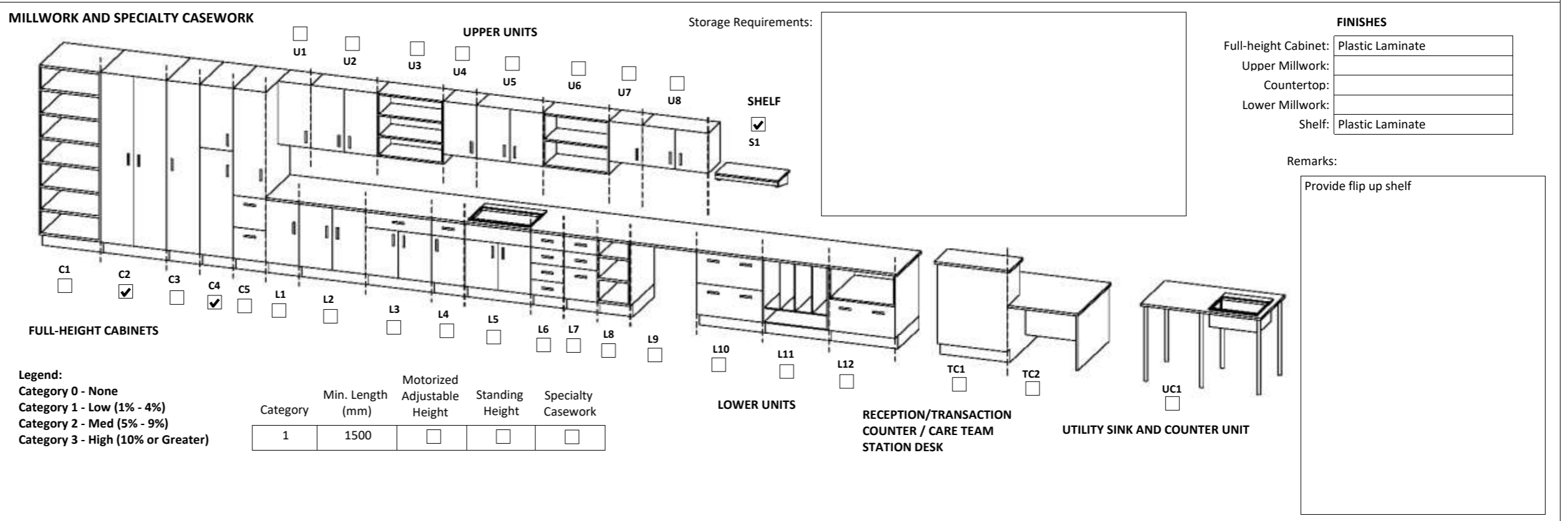

**MECHANICAL REQUIREMENTS**

<b>PLUMBING</b> (Quantity) Hand Hygiene Sink: <input type="text" value="1"/> Lavatory: <input type="text"/> Kitchen Sink: <input type="text"/> Seamless Kitchen Sink: <input type="text"/> Utility / Process Sink: <input type="text"/> Scrub Sink: <input type="text"/> Floor Sink: <input type="text"/> Plumbing Remarks: <input type="text"/>	Other Fixtures: <input type="checkbox"/> Shower <input type="checkbox"/> Eyewash Station <input type="checkbox"/> Tub <input type="checkbox"/> Eyewash/Shower Station <input type="checkbox"/> Ice Maker <input type="checkbox"/> Emergency Shower <input type="checkbox"/> Water Closet <input type="checkbox"/> Flush Rim Sink <input type="checkbox"/> Instantaneous Hot Water <input type="checkbox"/> Floor Drain <input type="checkbox"/> <input type="checkbox"/> Water Bottle Refill Station Other: <input type="text"/>	<b>MED / NON-MED GASES</b> (Quantity) Oxygen: <input type="text" value="5"/> Medical Air: <input type="text" value="3"/> Medical Vacuum: <input type="text" value="5"/> Nitrous Oxide: <input type="text"/> CO2: <input type="text"/> AGSS: <input type="text"/> Nitrogen: <input type="text"/> Laboratory Air: <input type="text"/> Laboratory Vacuum: <input type="text"/> Utility Compressed Air: <input type="text"/> Gas Remarks: Provide medical gases (each boom with (2) O2, (1) Medical Air, (2) Medical Vacuum and 1 set of wall outlets ((1) O2, (1) Air, (1) Medical Vacuum)
---	---	---

# Appendix 1B Minimum Room Requirements

Room Name:

Program Number(s):

1. B1.01	7.	13.	19.	25.	31.	37.	43.
2. B2.01	8.	14.	20.	26.	32.	38.	44.
3.	9.	15.	21.	27.	33.	39.	45.
4.	10.	16.	22.	28.	34.	40.	46.
5.	11.	17.	23.	29.	35.	41.	47.
6.	12.	18.	24.	30.	36.	42.	48.

## ARCHITECTURAL REQUIREMENTS

<b>WALL AND CEILING</b> Wall Material: <input type="text" value="ARGB 1.2m AFF, GB above"/> Finish: <input type="text" value="PT"/> Ceiling Material: <input type="text" value="ACT"/> Finish: <input type="text" value="PF"/>		<b>WALL PROTECTION</b> Type: <input type="text" value="PVW"/> <input checked="" type="checkbox"/> Corner Guards <input type="checkbox"/> Hand Rails <input checked="" type="checkbox"/> Bed Bumper / Locator Height: <input type="text" value="1350 mm"/> <input type="checkbox"/> Crash Rails <input type="checkbox"/> Chair Rail		<b>GLAZING</b> <input checked="" type="checkbox"/> Interior Glazing		<b>FLOORING TYPES</b> Material: <input type="text" value="VSF"/> Base: <input type="text" value="FCB"/>		<b>ROOM ACCESSORIES</b> <input checked="" type="checkbox"/> Coat Hooks <input checked="" type="checkbox"/> Ceiling Lift <input checked="" type="checkbox"/> Magnetic Whiteboard <input type="checkbox"/> Mirror <input type="checkbox"/> Infant Change Table <input checked="" type="checkbox"/> Privacy Curtain	
--	--	--	--	--	--	--	--	--	--

- LEGEND:**
- WALL AND CEILING LEGEND:**
- AC Architectural Ceiling
  - ACT Acoustic Ceiling Tile
  - ACT-C Cleanroom
  - ARGB Abuse-Resistant Gypsum Board
  - GB Gypsum Board
  - IRGB Impact-Resistant Gypsum Board
  - KLCT Kitchen Lay-in Ceiling Tile
  - MMRGB Moisture and Mould-Resistant Gypsum Board
  - SACT Security Acoustic Ceiling Tile
- WALL FINISHES LEGEND:**
- EWC Epoxy Wall Coating
  - HPC High Performance Coating
  - PT Paint
- CEILING FINISHES LEGEND:**
- ECC Epoxy Ceiling Coating
  - HPC High Performance Coating
  - PF Prefinished
  - PT Paint
- WALL PROTECTION LEGEND:**
- ESRP Extruded Semi-Rigid PVCu Panel
  - FRL Fibre Reinforced Laminate
  - FRP Fibreglass Reinforced Plastic
  - PVW Protective Vinyl Wallcovering
  - RHIS Rigid High Impact Sheet
  - WSSP Wetwall Solid Surface Panel
  - WVV Wetroom Vinyl Wallcovering
- FLOOR FINISHES LEGEND:**
- CFS Concrete Floor Sealer
  - EFC Epoxy Floor Coating
  - PFC Polyurethane Floor Coating
  - RAF Rubber Athletic Flooring
  - RSF Rubber Sheet Flooring
  - SCF Seamless Cushioned Flooring
  - SDRF Static-Dissipative Rubber Sheet Flooring
  - SDVF Static-Dissipative Vinyl Sheet Flooring
  - VSF Vinyl Sheet Flooring
  - WSVF Wetroom Safety Vinyl Sheet Flooring
- FLOOR BASE LEGEND:**
- FCB Flash Cove Base
  - RB Rubber Base
  - SCF Seamless Cushioned Flooring

**DOORS**

Types:

Note: for Type F doors, the door panels will be approximately 465/1065 unless otherwise required by the Authority

Door Remarks:  Security Grille  Anti-barricade strategy

F2 door to have a half window

Type	Qty	Size (mm)	Material	Finish	Side Lt	Blinds	Protect	Privacy Film	Function	Card Reader	Mag Lock	Auto Opener	Hold Open	Hinges	Accessory 1	Accessory 2	Accessory 3	Closer
F2	1	1530 x 2135	Solid Core	FRL	<input type="checkbox"/>	<input type="checkbox"/>	2 High	<input type="checkbox"/>	Passage	<input type="checkbox"/>	<input type="checkbox"/>	<input type="checkbox"/>	<input type="checkbox"/>	Butt Hinge	Astragal	Flush Bolt		Surface

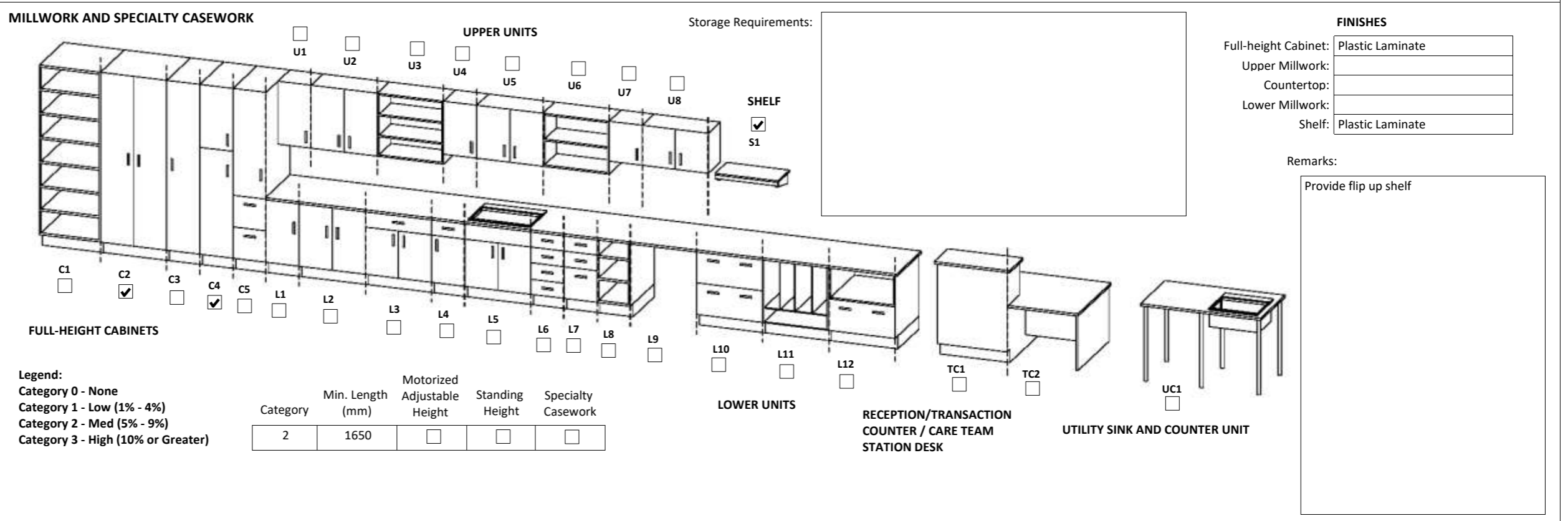

## MECHANICAL REQUIREMENTS

<b>PLUMBING</b> (Quantity)		Hand Hygiene Sink: <input type="text" value="1"/>		Lavatory: <input type="text"/>		Kitchen Sink: <input type="text"/>		Seamless Kitchen Sink: <input type="text"/>		Utility / Process Sink: <input type="text"/>		Scrub Sink: <input type="text"/>		Floor Sink: <input type="text"/>		Other Fixtures:		<b>MED / NON-MED GASES</b> (Quantity)	
Plumbing Remarks:		<input type="checkbox"/> Shower		<input type="checkbox"/> Tub		<input type="checkbox"/> Ice Maker		<input type="checkbox"/> Water Closet		<input type="checkbox"/> Instantaneous Hot Water		<input type="checkbox"/> Eyewash Station		<input type="checkbox"/> Eyewash/Shower Station		<input type="checkbox"/> Emergency Shower		<input type="checkbox"/> Flush Rim Sink	
		<input type="checkbox"/> Floor Drain		<input type="checkbox"/> Water Bottle Refill Station		Other: <input type="text"/>		Oxygen: <input type="text" value="4"/>		Medical Air: <input type="text" value="2"/>		Medical Vacuum: <input type="text" value="4"/>		Nitrous Oxide: <input type="text"/>		CO2: <input type="text"/>		AGSS: <input type="text"/>	
		Laboratory Air: <input type="text"/>		Laboratory Vacuum: <input type="text"/>		Utility Compressed Air: <input type="text"/>		Gas Remarks:		<input type="text" value="Provide medical gases on both sides of the bed ((2) O2, (1) Medical Air, (2) Medical Vacuum per side)"/>									

**Appendix 1B Minimum Room Requirements**

Room Name:

Program Number(s):	1. B2.03	7.	13.	19.	25.	31.	37.	43.
	2.	8.	14.	20.	26.	32.	38.	44.
	3.	9.	15.	21.	27.	33.	39.	45.
	4.	10.	16.	22.	28.	34.	40.	46.
	5.	11.	17.	23.	29.	35.	41.	47.
	6.	12.	18.	24.	30.	36.	42.	48.

**ARCHITECTURAL REQUIREMENTS**

<b>WALL AND CEILING</b> Wall Material: <input type="text" value="ARGB 1.2m AFF, GB above"/> Finish: <input type="text" value="PT"/> Ceiling Material: <input type="text" value="ACT"/> Finish: <input type="text" value="PF"/>	<b>WALL PROTECTION</b> Type: <input type="text" value="PVW"/> <input checked="" type="checkbox"/> Corner Guards <input type="checkbox"/> Hand Rails <input checked="" type="checkbox"/> Bed Bumper / Locator Height: <input type="text" value="1350 mm"/> <input type="checkbox"/> Crash Rails <input type="checkbox"/> Chair Rail	<b>GLAZING</b> <input checked="" type="checkbox"/> Interior Glazing	<b>FLOORING TYPES</b> Material: <input type="text" value="VSF"/> Base: <input type="text" value="FCB"/>	<b>ROOM ACCESSORIES</b> <input checked="" type="checkbox"/> Coat Hooks <input checked="" type="checkbox"/> Ceiling Lift <input checked="" type="checkbox"/> Magnetic Whiteboard <input type="checkbox"/> Mirror <input type="checkbox"/> Infant Change Table <input checked="" type="checkbox"/> Privacy Curtain
--	--	--	--	--

- LEGEND:**
- WALL AND CEILING LEGEND:**
- AC Architectural Ceiling
  - ACT Acoustic Ceiling Tile
  - ACT-C Cleanroom
  - ARGB Abuse-Resistant Gypsum Board
  - GB Gypsum Board
  - IRGB Impact-Resistant Gypsum Board
  - KLCT Kitchen Lay-in Ceiling Tile
  - MMRGB Moisture and Mould-Resistant Gypsum Board
  - SACT Security Acoustic Ceiling Tile
- WALL FINISHES LEGEND:**
- EWC Epoxy Wall Coating
  - HPC High Performance Coating
  - PT Paint
- CEILING FINISHES LEGEND:**
- ECC Epoxy Ceiling Coating
  - HPC High Performance Coating
  - PF Prefinished
  - PT Paint
- WALL PROTECTION LEGEND:**
- ESRP Extruded Semi-Rigid PVCu Panel
  - FRL Fibre Reinforced Laminate
  - FRP Fibreglass Reinforced Plastic
  - PVW Protective Vinyl Wallcovering
  - RHIS Rigid High Impact Sheet
  - WSSP Wetwall Solid Surface Panel
  - WVV Wetroom Vinyl Wallcovering
- FLOOR FINISHES LEGEND:**
- CFS Concrete Floor Sealer
  - EFC Epoxy Floor Coating
  - PFC Polyurethane Floor Coating
  - RAF Rubber Athletic Flooring
  - RSF Rubber Sheet Flooring
  - SCF Seamless Cushioned Flooring
  - SDRF Static-Dissipative Rubber Sheet Flooring
  - SDVF Static-Dissipative Vinyl Sheet Flooring
  - VSF Vinyl Sheet Flooring
  - WSVF Wetroom Safety Vinyl Sheet Flooring
- FLOOR BASE LEGEND:**
- FCB Flash Cove Base
  - RB Rubber Base
  - SCF Seamless Cushioned Flooring

**DOORS**

Types:

Note: for Type F doors, the door panels will be approximately 465/1065 unless otherwise required by the Authority

Door Remarks:  Security Grille  Anti-barricade strategy

F2 door to have a half window

Type	Qty	Size (mm)	Material	Finish	Side Lt.	Blinds	Protect.	Privacy Film	Function	Card Reader	Mag Lock	Auto Opener	Hold Open	Hinges	Accessory 1	Accessory 2	Accessory 3	Closer
F2	1	1530 x 2135	Hollow Metal	Paint	<input type="checkbox"/>	<input type="checkbox"/>	2 High	<input type="checkbox"/>	Passage	<input type="checkbox"/>	<input type="checkbox"/>	<input type="checkbox"/>	<input type="checkbox"/>	Butt Hinge	Astragal	Flush Bolt		Surface

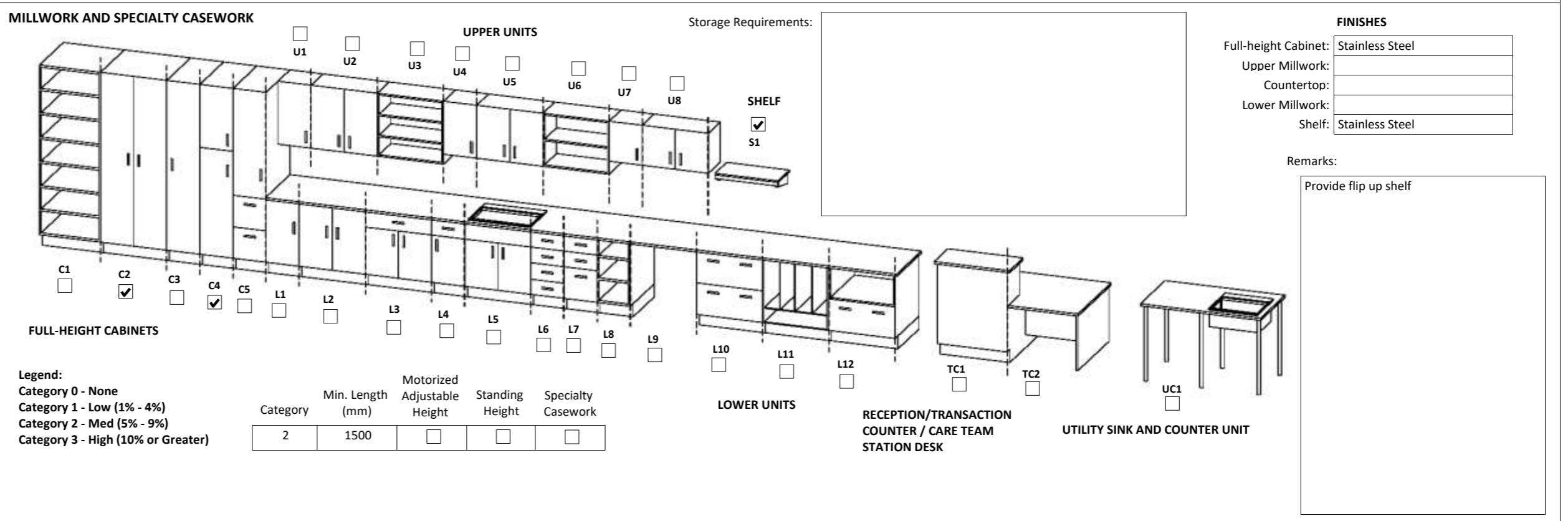

**MECHANICAL REQUIREMENTS**

<b>PLUMBING</b> (Quantity) Hand Hygiene Sink: <input type="text" value="1"/> Lavatory: <input type="text"/> Kitchen Sink: <input type="text"/> Seamless Kitchen Sink: <input type="text"/> Utility / Process Sink: <input type="text"/> Scrub Sink: <input type="text"/> Floor Sink: <input type="text"/> Plumbing Remarks: <input type="text"/>	Other Fixtures: <input type="checkbox"/> Shower <input type="checkbox"/> Tub <input type="checkbox"/> Ice Maker <input type="checkbox"/> Water Closet <input type="checkbox"/> Instantaneous Hot Water <input type="checkbox"/> Eyewash Station <input type="checkbox"/> Eyewash/Shower Station <input type="checkbox"/> Emergency Shower <input type="checkbox"/> Flush Rim Sink <input type="checkbox"/> Floor Drain <input type="checkbox"/> Water Bottle Refill Station Other: <input type="text"/>	<b>MED / NON-MED GASES</b> (Quantity) Oxygen: <input type="text" value="4"/> Medical Air: <input type="text" value="2"/> Medical Vacuum: <input type="text" value="4"/> Nitrous Oxide: <input type="text"/> CO2: <input type="text"/> AGSS: <input type="text"/> Nitrogen: <input type="text"/> Laboratory Air: <input type="text"/> Laboratory Vacuum: <input type="text"/> Utility Compressed Air: <input type="text"/> Gas Remarks: <input type="text" value="Provide medical gases on both sides of the bed ((2) O2, (1) Medical Air, (2) Medical Vacuum on each side)"/>
--	--	--



**Appendix 1B Minimum Room Requirements**

Room Name:

Program Number(s):

1. A2.02	7. U2.05	13.	19.	25.	31.	37.	43.
2. A3.02	8. Y5.02	14.	20.	26.	32.	38.	44.
3. F8.05	9.	15.	21.	27.	33.	39.	45.
4. M2.28	10.	16.	22.	28.	34.	40.	46.
5. N3.03	11.	17.	23.	29.	35.	41.	47.
6. S1.02	12.	18.	24.	30.	36.	42.	48.

**ARCHITECTURAL REQUIREMENTS**

<b>WALL AND CEILING</b> Wall Material: <input type="text" value="GB"/> Finish: <input type="text" value="PT"/> Ceiling Material: <input type="text" value="ACT"/> Finish: <input type="text" value="PF"/>		<b>WALL PROTECTION</b> Type: <input type="text"/> Height: <input type="text"/> <input checked="" type="checkbox"/> Corner Guards <input type="checkbox"/> Hand Rails <input type="checkbox"/> Bed Bumper / Locator <input type="checkbox"/> Crash Rails <input checked="" type="checkbox"/> Chair Rail		<b>GLAZING</b> <input type="checkbox"/> Interior Glazing		<b>FLOORING TYPES</b> Material: <input type="text" value="RSF"/> Base: <input type="text" value="FCB"/>		<b>ROOM ACCESSORIES</b> <input type="checkbox"/> Coat Hooks <input type="checkbox"/> Ceiling Lift <input checked="" type="checkbox"/> Magnetic Whiteboard <input type="checkbox"/> Mirror <input type="checkbox"/> Infant Change Table <input type="checkbox"/> Privacy Curtain	
---	--	---	--	---	--	--	--	---	--

- LEGEND:**
- WALL AND CEILING LEGEND:**
- AC Architectural Ceiling
  - ACT Acoustic Ceiling Tile
  - ACT-C Cleanroom
  - ARGB Abuse-Resistant Gypsum Board
  - GB Gypsum Board
  - IRGB Impact-Resistant Gypsum Board
  - KLCT Kitchen Lay-in Ceiling Tile
  - MMRGB Moisture and Mould-Resistant Gypsum Board
  - SACT Security Acoustic Ceiling Tile
- WALL FINISHES LEGEND:**
- EWC Epoxy Wall Coating
  - HPC High Performance Coating
  - PT Paint
- CEILING FINISHES LEGEND:**
- ECC Epoxy Ceiling Coating
  - HPC High Performance Coating
  - PF Prefinished
  - PT Paint
- WALL PROTECTION LEGEND:**
- ESRP Extruded Semi-Rigid PVCu Panel
  - FRL Fibre Reinforced Laminate
  - FRP Fibreglass Reinforced Plastic
  - PVV Protective Vinyl Wallcovering
  - RHIS Rigid High Impact Sheet
  - WSSP Wetwall Solid Surface Panel
  - WVV Wetroom Vinyl Wallcovering
- FLOOR FINISHES LEGEND:**
- CFS Concrete Floor Sealer
  - EFC Epoxy Floor Coating
  - PFC Polyurethane Floor Coating
  - RAF Rubber Athletic Flooring
  - RSF Rubber Sheet Flooring
  - SCF Seamless Cushioned Flooring
  - SDRF Static-Dissipative Rubber Sheet Flooring
  - SDVF Static-Dissipative Vinyl Sheet Flooring
  - VSF Vinyl Sheet Flooring
  - WSVF Wetroom Safety Vinyl Sheet Flooring
- FLOOR BASE LEGEND:**
- FCB Flash Cove Base
  - RB Rubber Base
  - SCF Seamless Cushioned Flooring

**DOORS**

Types:

Type	Qty	Size (mm)	Material	Finish	Side Lt.	Blinds	Protect.	Film	Function	Card Reader	Mag Lock	Auto Opener	Hold Open	Hinges	Accessory 1	Accessory 2	Accessory 3	Closer
C	1	915 x 2135	Solid Core	FRL	<input checked="" type="checkbox"/>	<input type="checkbox"/>	1 Low	<input type="checkbox"/>	Passage	<input type="checkbox"/>	<input type="checkbox"/>	<input type="checkbox"/>	<input type="checkbox"/>	Butt Hinge				Surface

Door Remarks:

Security Grille  
 Anti-barricade strategy



**MECHANICAL REQUIREMENTS**

<b>PLUMBING</b> (Quantity) Hand Hygiene Sink: <input type="text"/> Lavatory: <input type="text"/> Kitchen Sink: <input type="text"/> Seamless Kitchen Sink: <input type="text"/> Utility / Process Sink: <input type="text"/> Scrub Sink: <input type="text"/> Floor Sink: <input type="text"/>							Other Fixtures: <input type="checkbox"/> Shower <input type="checkbox"/> Tub <input type="checkbox"/> Ice Maker <input type="checkbox"/> Water Closet <input type="checkbox"/> Instantaneous Hot Water				<input type="checkbox"/> Eyewash Station <input type="checkbox"/> Eyewash/Shower Station <input type="checkbox"/> Emergency Shower <input type="checkbox"/> Flush Rim Sink <input type="checkbox"/> Floor Drain <input type="checkbox"/> Water Bottle Refill Station Other: <input type="text"/>				<b>MED / NON-MED GASES</b> (Quantity) Oxygen: <input type="text"/> Medical Air: <input type="text"/> Medical Vacuum: <input type="text"/> Nitrous Oxide: <input type="text"/> CO2: <input type="text"/> AGSS: <input type="text"/> Nitrogen: <input type="text"/> Laboratory Air: <input type="text"/> Laboratory Vacuum: <input type="text"/> Utility Compressed Air: <input type="text"/>					
Plumbing Remarks: <input type="text"/>											Gas Remarks: <input type="text"/>									

**Appendix 1B Minimum Room Requirements**

Room Name:

Program Number(s):

1. E6.03	7.	13.	19.	25.	31.	37.	43.
2. J4.06	8.	14.	20.	26.	32.	38.	44.
3. M1.11	9.	15.	21.	27.	33.	39.	45.
4. P1.08	10.	16.	22.	28.	34.	40.	46.
5. W6.01	11.	17.	23.	29.	35.	41.	47.
6.	12.	18.	24.	30.	36.	42.	48.

**ARCHITECTURAL REQUIREMENTS**

<b>WALL AND CEILING</b> Wall Material: <input type="text" value="ARGB 1.2m AFF, GB above"/> Finish: <input type="text" value="EWC"/> Ceiling Material: <input type="text" value="MMRGB"/> Finish: <input type="text" value="ECC"/>		<b>WALL PROTECTION</b> Type: <input type="text" value="ESRP"/> <input checked="" type="checkbox"/> Corner Guards <input type="checkbox"/> Hand Rails <input type="checkbox"/> Bed Bumper / Locator Height: <input type="text" value="1600 mm"/> <input checked="" type="checkbox"/> Crash Rails <input type="checkbox"/> Chair Rail		<b>GLAZING</b> <input type="checkbox"/> Interior Glazing		<b>FLOORING TYPES</b> Material: <input type="text" value="WSVF"/> Base: <input type="text" value="FCB"/>		<b>ROOM ACCESSORIES</b> <input type="checkbox"/> Coat Hooks <input type="checkbox"/> Ceiling Lift <input type="checkbox"/> Magnetic Whiteboard <input type="checkbox"/> Mirror <input type="checkbox"/> Infant Change Table <input type="checkbox"/> Privacy Curtain	
--	--	---	--	---	--	---	--	--	--

- LEGEND:**
- WALL AND CEILING LEGEND:**
- AC Architectural Ceiling
  - ACT Acoustic Ceiling Tile
  - ACT-C Cleanroom
  - ARGB Abuse-Resistant Gypsum Board
  - GB Gypsum Board
  - IRGB Impact-Resistant Gypsum Board
  - KLCT Kitchen Lay-in Ceiling Tile
  - MMRGB Moisture and Mould-Resistant Gypsum Board
  - SACT Security Acoustic Ceiling Tile
- WALL FINISHES LEGEND:**
- EWC Epoxy Wall Coating
  - HPC High Performance Coating
  - PT Paint
- CEILING FINISHES LEGEND:**
- ECC Epoxy Ceiling Coating
  - HPC High Performance Coating
  - PF Prefinished
  - PT Paint
- WALL PROTECTION LEGEND:**
- ESRP Extruded Semi-Rigid PVCu Panel
  - FRL Fibre Reinforced Laminate
  - FRP Fibreglass Reinforced Plastic
  - PVV Protective Vinyl Wallcovering
  - RHIS Rigid High Impact Sheet
  - WSSP Wetwall Solid Surface Panel
  - WWW Wetroom Vinyl Wallcovering
- FLOOR FINISHES LEGEND:**
- CFS Concrete Floor Sealer
  - EFC Epoxy Floor Coating
  - PFC Polyurethane Floor Coating
  - RAF Rubber Athletic Flooring
  - RSF Rubber Sheet Flooring
  - SCF Seamless Cushioned Flooring
  - SDRF Static-Dissipative Rubber Sheet Flooring
  - SDVF Static-Dissipative Vinyl Sheet Flooring
  - VSF Vinyl Sheet Flooring
  - WSVF Wetroom Safety Vinyl Sheet Flooring
- FLOOR BASE LEGEND:**
- FCB Flash Cove Base
  - RB Rubber Base
  - SCF Seamless Cushioned Flooring

**DOORS**

Types:

Type	Qty	Size (mm)	Material	Finish	Side Lt.	Blinds	Protect.	Privacy Film	Function	Card Reader	Mag Lock	Auto Opener	Hold Open	Hinges	Accessory 1	Accessory 2	Accessory 3	Closer
C	1	1220 x 2135	Hollow Metal	Paint	<input type="checkbox"/>	<input type="checkbox"/>		<input type="checkbox"/>	Storeroom	<input checked="" type="checkbox"/>	<input type="checkbox"/>	<input checked="" type="checkbox"/>	<input type="checkbox"/>	Butt Hinge	Elec. Strike			Surface

Door Remarks: For E6.03, J4.06 and M1.11 provide Push/Pull with hold open, no card reader or Automatic Opener required.

Security Grille  
 Anti-barricade strategy



**MECHANICAL REQUIREMENTS**

<b>PLUMBING</b> (Quantity)		Hand Hygiene Sink: <input type="text" value="1"/>		Lavatory: <input type="text"/>		Kitchen Sink: <input type="text"/>		Seamless Kitchen Sink: <input type="text"/>		Utility / Process Sink: <input type="text"/>		Scrub Sink: <input type="text"/>		Floor Sink: <input type="text"/>							
Plumbing Remarks:		Provide HHS for E6.03 and W6.01																			
		Other Fixtures:				<input type="checkbox"/> Shower <input type="checkbox"/> Tub <input type="checkbox"/> Ice Maker <input type="checkbox"/> Water Closet <input type="checkbox"/> Instantaneous Hot Water				<input type="checkbox"/> Eyewash Station <input type="checkbox"/> Eyewash/Shower Station <input type="checkbox"/> Emergency Shower <input type="checkbox"/> Flush Rim Sink <input type="checkbox"/> Floor Drain <input type="checkbox"/> Water Bottle Refill Station				Other: <input type="text"/>							
		<b>MED / NON-MED GASES</b> (Quantity)																			
		Oxygen: <input type="text"/>		Medical Air: <input type="text"/>		Medical Vacuum: <input type="text"/>		Nitrous Oxide: <input type="text"/>		CO2: <input type="text"/>		AGSS: <input type="text"/>		Nitrogen: <input type="text"/>		Laboratory Air: <input type="text"/>		Laboratory Vacuum: <input type="text"/>		Utility Compressed Air: <input type="text"/>	
		Gas Remarks: <input type="text"/>																			

**Appendix 1B Minimum Room Requirements**

Room Name:

Program Number(s):

1. J4.05	7.	13.	19.	25.	31.	37.	43.
2. R1.03	8.	14.	20.	26.	32.	38.	44.
3.	9.	15.	21.	27.	33.	39.	45.
4.	10.	16.	22.	28.	34.	40.	46.
5.	11.	17.	23.	29.	35.	41.	47.
6.	12.	18.	24.	30.	36.	42.	48.

**ARCHITECTURAL REQUIREMENTS**

<b>WALL AND CEILING</b> Wall Material: <input type="text" value="ARGB 1.2m AFF, GB above"/> Finish: <input type="text" value="EWC"/> Ceiling Material: <input type="text" value="GB"/> Finish: <input type="text" value="ECC"/>		<b>WALL PROTECTION</b> Type: <input type="text" value="ESRP"/> <input checked="" type="checkbox"/> Corner Guards <input type="checkbox"/> Hand Rails <input type="checkbox"/> Bed Bumper / Locator Height: <input type="text" value="2185 mm"/> <input type="checkbox"/> Crash Rails <input type="checkbox"/> Chair Rail		<b>GLAZING</b> <input type="checkbox"/> Interior Glazing		<b>FLOORING TYPES</b> Material: <input type="text" value="WSVF"/> Base: <input type="text" value="FCB"/>		<b>ROOM ACCESSORIES</b> <input type="checkbox"/> Coat Hooks <input type="checkbox"/> Ceiling Lift <input type="checkbox"/> Magnetic Whiteboard <input type="checkbox"/> Mirror <input type="checkbox"/> Infant Change Table <input type="checkbox"/> Privacy Curtain	
---	--	--	--	---	--	---	--	--	--

- LEGEND:**
- WALL AND CEILING LEGEND:**
- AC Architectural Ceiling
  - ACT Acoustic Ceiling Tile
  - ACT-C Cleanroom
  - ARGB Abuse-Resistant Gypsum Board
  - GB Gypsum Board
  - IRGB Impact-Resistant Gypsum Board
  - KLCT Kitchen Lay-in Ceiling Tile
  - MMRGB Moisture and Mould-Resistant Gypsum Board
  - SACT Security Acoustic Ceiling Tile
- WALL FINISHES LEGEND:**
- EWC Epoxy Wall Coating
  - HPC High Performance Coating
  - PT Paint
- CEILING FINISHES LEGEND:**
- ECC Epoxy Ceiling Coating
  - HPC High Performance Coating
  - PF Prefinished
  - PT Paint
- WALL PROTECTION LEGEND:**
- ESRP Extruded Semi-Rigid PVCu Panel
  - FRL Fibre Reinforced Laminate
  - FRP Fibreglass Reinforced Plastic
  - PVV Protective Vinyl Wallcovering
  - RHIS Rigid High Impact Sheet
  - WSSP Wetwall Solid Surface Panel
  - WVV Wetroom Vinyl Wallcovering
- FLOOR FINISHES LEGEND:**
- CFS Concrete Floor Sealer
  - EFC Epoxy Floor Coating
  - PFC Polyurethane Floor Coating
  - RAF Rubber Athletic Flooring
  - RSF Rubber Sheet Flooring
  - SCF Seamless Cushioned Flooring
  - SDRF Static-Dissipative Rubber Sheet Flooring
  - SDVF Static-Dissipative Vinyl Sheet Flooring
  - VSF Vinyl Sheet Flooring
  - WSVF Wetroom Safety Vinyl Sheet Flooring
- FLOOR BASE LEGEND:**
- FCB Flash Cove Base
  - RB Rubber Base
  - SCF Seamless Cushioned Flooring

**DOORS**

Types:

Type	Qty	Size (mm)	Material	Finish	Side Lt.	Blinds	Protect.	Privacy Film	Function	Card Reader	Mag Lock	Auto Opener	Hold Open	Hinges	Accessory 1	Accessory 2	Accessory 3	Closer
C	1	1220 x 2135	Solid Core	FRL	<input type="checkbox"/>	<input type="checkbox"/>	2 High	<input type="checkbox"/>	Passage	<input type="checkbox"/>	<input type="checkbox"/>	<input type="checkbox"/>	<input checked="" type="checkbox"/>	Cont. Swing Clear				Surface

**DOOR REMARKS:**

Security Grille  
 Anti-barricade strategy

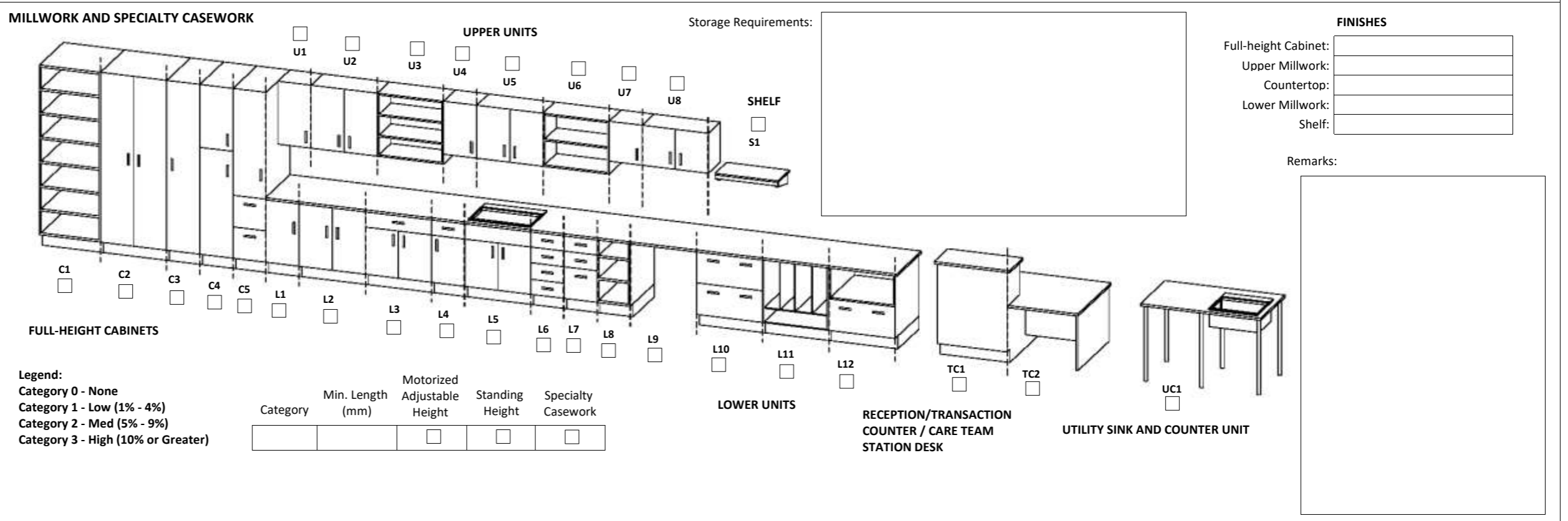

**MECHANICAL REQUIREMENTS**

<b>PLUMBING</b> (Quantity) Hand Hygiene Sink: <input type="text"/> Lavatory: <input type="text"/> Kitchen Sink: <input type="text"/> Seamless Kitchen Sink: <input type="text"/> Utility / Process Sink: <input type="text"/> Scrub Sink: <input type="text"/> Floor Sink: <input type="text"/> Plumbing Remarks: <input type="text"/>		<b>Other Fixtures:</b> <input type="checkbox"/> Shower <input type="checkbox"/> Eyewash Station <input type="checkbox"/> Tub <input type="checkbox"/> Eyewash/Shower Station <input type="checkbox"/> Ice Maker <input type="checkbox"/> Emergency Shower <input type="checkbox"/> Water Closet <input type="checkbox"/> Flush Rim Sink <input type="checkbox"/> Instantaneous Hot Water <input type="checkbox"/> Floor Drain <input type="checkbox"/> Water Bottle Refill Station Other: <input type="text"/>		<b>MED / NON-MED GASES</b> (Quantity) Oxygen: <input type="text"/> Medical Air: <input type="text"/> Medical Vacuum: <input type="text"/> Nitrous Oxide: <input type="text"/> CO2: <input type="text"/> AGSS: <input type="text"/> Nitrogen: <input type="text"/> Laboratory Air: <input type="text"/> Laboratory Vacuum: <input type="text"/> Utility Compressed Air: <input type="text"/> Gas Remarks: <input type="text"/>	
---	--	---	--	---	--



**Appendix 1B Minimum Room Requirements**

Room Name:

Program Number(s):

1. A4.05	7. C5.11	13. I2.19	19.	25.	31.	37.	43.
2. B1.15	8. D6.19	14. L1.16	20.	26.	32.	38.	44.
3. B2.19	9. F3.14	15. L2.15	21.	27.	33.	39.	45.
4. B3.17	10. F4.21	16. M2.11	22.	28.	34.	40.	46.
5. C3.32	11. F5.18	17. M2.33	23.	29.	35.	41.	47.
6. C4.27	12. G1.15	18.	24.	30.	36.	42.	48.

**ARCHITECTURAL REQUIREMENTS**

<b>WALL AND CEILING</b> Wall Material: <input type="text" value="ARGB 1.2m AFF, GB above"/> Finish: <input type="text" value="EWC"/> Ceiling Material: <input type="text" value="GB"/> Finish: <input type="text" value="ECC"/>		<b>WALL PROTECTION</b> Type: <input type="text" value="WVW"/> <input checked="" type="checkbox"/> Corner Guards <input type="checkbox"/> Hand Rails <input type="checkbox"/> Bed Bumper / Locator Height: <input type="text" value="2185 mm"/> <input checked="" type="checkbox"/> Crash Rails <input type="checkbox"/> Chair Rail		<b>GLAZING</b> <input type="checkbox"/> Interior Glazing		<b>FLOORING TYPES</b> Material: <input type="text" value="WSVF"/> Base: <input type="text" value="FCB"/>		<b>ROOM ACCESSORIES</b> <input type="checkbox"/> Coat Hooks <input type="checkbox"/> Ceiling Lift <input type="checkbox"/> Magnetic Whiteboard <input type="checkbox"/> Mirror <input type="checkbox"/> Infant Change Table <input type="checkbox"/> Privacy Curtain	
---	--	--	--	---	--	---	--	--	--

- LEGEND:**
- WALL AND CEILING LEGEND:**
- AC Architectural Ceiling
  - ACT Acoustic Ceiling Tile
  - ACT-C Cleanroom
  - ARGB Abuse-Resistant Gypsum Board
  - GB Gypsum Board
  - IRGB Impact-Resistant Gypsum Board
  - KLCT Kitchen Lay-in Ceiling Tile
  - MMRGB Moisture and Mould-Resistant Gypsum Board
  - SACT Security Acoustic Ceiling Tile
- WALL FINISHES LEGEND:**
- EWC Epoxy Wall Coating
  - HPC High Performance Coating
  - PT Paint
- CEILING FINISHES LEGEND:**
- ECC Epoxy Ceiling Coating
  - HPC High Performance Coating
  - PF Prefinished
  - PT Paint
- WALL PROTECTION LEGEND:**
- ESRP Extruded Semi-Rigid PVCu Panel
  - FRL Fibre Reinforced Laminate
  - FRP Fibreglass Reinforced Plastic
  - PVW Protective Vinyl Wallcovering
  - RHIS Rigid High Impact Sheet
  - WSSP Wetwall Solid Surface Panel
  - WVV Wetroom Vinyl Wallcovering
- FLOOR FINISHES LEGEND:**
- CFS Concrete Floor Sealer
  - EFC Epoxy Floor Coating
  - PFC Polyurethane Floor Coating
  - RAF Rubber Athletic Flooring
  - RSF Rubber Sheet Flooring
  - SCF Seamless Cushioned Flooring
  - SDRF Static-Dissipative Rubber Sheet Flooring
  - SDVF Static-Dissipative Vinyl Sheet Flooring
  - VSF Vinyl Sheet Flooring
  - WSVF Wetroom Safety Vinyl Sheet Flooring
- FLOOR BASE LEGEND:**
- FCB Flash Cove Base
  - RB Rubber Base
  - SCF Seamless Cushioned Flooring

**DOORS**

Types:

Type	Qty	Size (mm)	Material	Finish	Side Lt.	Blinds	Protect.	Privacy Film	Function	Card Reader	Mag Lock	Auto Opener	Hold Open	Hinges	Accessory 1	Accessory 2	Accessory 3	Closer
C	1	1220 x 2135	Solid Core	FRL	<input type="checkbox"/>	<input type="checkbox"/>	2 High	<input type="checkbox"/>	Storeroom	<input checked="" type="checkbox"/>	<input type="checkbox"/>	<input checked="" type="checkbox"/>	<input type="checkbox"/>	Butt Hinge	Elec. Strike			Surface

Door Remarks:  Security Grille  Anti-barricade strategy

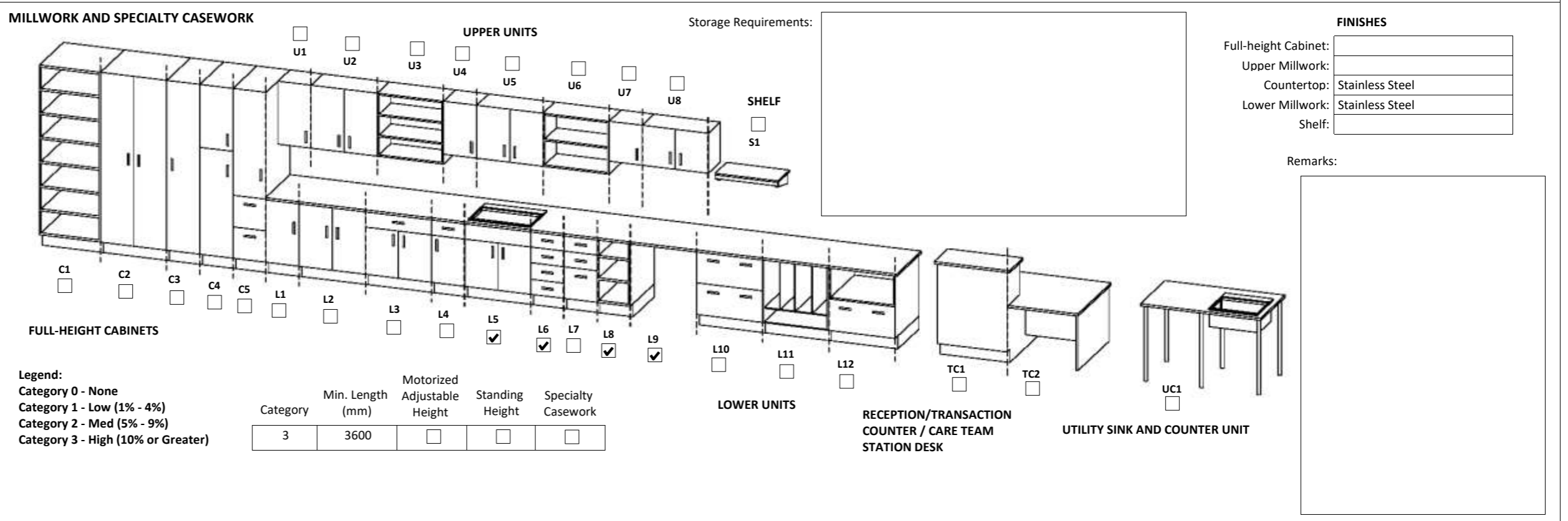

**MECHANICAL REQUIREMENTS**

<b>PLUMBING</b> (Quantity) Hygiene Sink: <input type="text" value="1"/> Lavatory: <input type="text"/> Kitchen Sink: <input type="text"/> Kitchen Sink: <input type="text"/> Utility / Process Sink: <input type="text" value="1"/> Scrub Sink: <input type="text"/> Floor Sink: <input type="text"/>		Other Fixtures: <input type="checkbox"/> Shower <input type="checkbox"/> Tub <input type="checkbox"/> Ice Maker <input type="checkbox"/> Water Closet <input type="checkbox"/> Instantaneous Hot Water		<input checked="" type="checkbox"/> Eyewash Station <input type="checkbox"/> Eyewash/Shower Station <input type="checkbox"/> Emergency Shower <input checked="" type="checkbox"/> Flush Rim Sink <input checked="" type="checkbox"/> Floor Drain <input type="checkbox"/> Water Bottle Refill Station Other: <input type="text"/>		<b>MED / NON-MED GASES</b> (Quantity) Oxygen: <input type="text"/> Medical Air: <input type="text"/> Medical Vacuum: <input type="text"/> Nitrous Oxide: <input type="text"/> CO2: <input type="text"/> AGSS: <input type="text"/> Nitrogen: <input type="text"/> Laboratory Air: <input type="text"/> Laboratory Vacuum: <input type="text"/> Utility Compressed Air: <input type="text"/>					
Plumbing Remarks: Provide wall-mounted, exposed emergency eyewash/drench hose unit, where recessed wall-mounted bedpan disinfectors are required, refer to Schedule 1 and Appendix 1H [Equipment and Furniture].						Gas Remarks: <input type="text"/>					

**Appendix 1B Minimum Room Requirements**

Room Name:

Program Number(s):

1. M1.10	7.	13.	19.	25.	31.	37.	43.
2. X3.04	8.	14.	20.	26.	32.	38.	44.
3.	9.	15.	21.	27.	33.	39.	45.
4.	10.	16.	22.	28.	34.	40.	46.
5.	11.	17.	23.	29.	35.	41.	47.
6.	12.	18.	24.	30.	36.	42.	48.

**ARCHITECTURAL REQUIREMENTS**

<b>WALL AND CEILING</b> Wall Material: <input type="text" value="ARGB 1.2m AFF, GB above"/> Finish: <input type="text" value="EWC"/> Ceiling Material: <input type="text" value="ACT"/> Finish: <input type="text" value="PF"/>		<b>WALL PROTECTION</b> Type: <input type="text" value="FRP"/> <input checked="" type="checkbox"/> Corner Guards <input type="checkbox"/> Hand Rails <input type="checkbox"/> Bed Bumper / Locator Height: <input type="text" value="1350 mm"/> <input type="checkbox"/> Crash Rails <input type="checkbox"/> Chair Rail		<b>GLAZING</b> <input type="checkbox"/> Interior Glazing		<b>FLOORING TYPES</b> Material: <input type="text" value="EFC"/> Base: <input type="text" value="FCB"/>		<b>ROOM ACCESSORIES</b> <input type="checkbox"/> Coat Hooks <input type="checkbox"/> Ceiling Lift <input checked="" type="checkbox"/> Magnetic Whiteboard <input type="checkbox"/> Mirror <input type="checkbox"/> Infant Change Table <input type="checkbox"/> Privacy Curtain	
---	--	---	--	---	--	--	--	---	--

- LEGEND:**
- WALL AND CEILING LEGEND:**
- AC Architectural Ceiling
  - ACT Acoustic Ceiling Tile
  - ACT-C Cleanroom
  - ARGB Abuse-Resistant Gypsum Board
  - GB Gypsum Board
  - IRGB Impact-Resistant Gypsum Board
  - KLCT Kitchen Lay-in Ceiling Tile
  - MMRGB Moisture and Mould-Resistant Gypsum Board
  - SACT Security Acoustic Ceiling Tile
- WALL FINISHES LEGEND:**
- EWC Epoxy Wall Coating
  - HPC High Performance Coating
  - PT Paint
- CEILING FINISHES LEGEND:**
- ECC Epoxy Ceiling Coating
  - HPC High Performance Coating
  - PF Prefinished
  - PT Paint
- WALL PROTECTION LEGEND:**
- ESRP Extruded Semi-Rigid PVCu Panel
  - FRL Fibre Reinforced Laminate
  - FRP Fibreglass Reinforced Plastic
  - PVV Protective Vinyl Wallcovering
  - RHIS Rigid High Impact Sheet
  - WSSP Wetwall Solid Surface Panel
  - WVV Wetroom Vinyl Wallcovering
- FLOOR FINISHES LEGEND:**
- CFS Concrete Floor Sealer
  - EFC Epoxy Floor Coating
  - PFC Polyurethane Floor Coating
  - RAF Rubber Athletic Flooring
  - RSF Rubber Sheet Flooring
  - SCF Seamless Cushioned Flooring
  - SDRF Static-Dissipative Rubber Sheet Flooring
  - SDVF Static-Dissipative Vinyl Sheet Flooring
  - VSF Vinyl Sheet Flooring
  - WSVF Wetroom Safety Vinyl Sheet Flooring
- FLOOR BASE LEGEND:**
- FCB Flash Cove Base
  - RB Rubber Base
  - SCF Seamless Cushioned Flooring

**DOORS**

Types:

Type	Qty	Size (mm)	Material	Finish	Side Lt.	Blinds	Protect.	Privacy Film	Function	Card Reader	Mag Lock	Auto Opener	Hold Open	Hinges	Accessory 1	Accessory 2	Accessory 3	Closer
C	1	1220 x 2135	Solid Core	FRL	<input type="checkbox"/>	<input type="checkbox"/>	2 High	<input type="checkbox"/>	Push/Pull	<input type="checkbox"/>	<input type="checkbox"/>	<input type="checkbox"/>	<input type="checkbox"/>	Cont. Swing Clear				Surface

Door Remarks:  Security Grille  Anti-barricade strategy



**MECHANICAL REQUIREMENTS**

<b>PLUMBING</b> (Quantity) Hygiene Sink: <input type="text"/> Lavatory: <input type="text"/> Kitchen Sink: <input type="text"/> Seamless Kitchen Sink: <input type="text"/> Utility / Process Sink: <input type="text"/> Scrub Sink: <input type="text"/> Floor Sink: <input type="text"/>							Other Fixtures: <input type="checkbox"/> Shower <input type="checkbox"/> Tub <input type="checkbox"/> Ice Maker <input type="checkbox"/> Water Closet <input type="checkbox"/> Instantaneous Hot Water			<input checked="" type="checkbox"/> Eyewash Station <input type="checkbox"/> Eyewash/Shower Station <input type="checkbox"/> Emergency Shower <input type="checkbox"/> Flush Rim Sink <input checked="" type="checkbox"/> Floor Drain <input type="checkbox"/> Water Bottle Refill Station Other <input type="text"/>			<b>MED / NON-MED GASES</b> (Quantity) Oxygen: <input type="text"/> Medical Air: <input type="text"/> Medical Vacuum: <input type="text"/> Nitrous Oxide: <input type="text"/> CO2: <input type="text"/> AGSS: <input type="text"/> Nitrogen: <input type="text"/> Laboratory Air: <input type="text"/> Laboratory Vacuum: <input type="text"/> Utility Compressed Air: <input type="text"/>					
Plumbing Remarks: <input type="text"/>										Gas Remarks: <input type="text"/>								

**Appendix 1B Minimum Room Requirements**

Room Name:

Program Number(s):

1. A4.03	7. C5.10	13. F7.10	19. N1.02	25.	31.	37.	43.
2. B2.27	8. D2.10	14. G1.22	20. N3.09	26.	32.	38.	44.
3. B3.18	9. D3.11	15. G1.23	21. P3.05	27.	33.	39.	45.
4. B4.03	10. D6.21	16. I2.16	22. S2.05	28.	34.	40.	46.
5. C3.31	11. F5.16	17. L1.13	23. V1.03	29.	35.	41.	47.
6. C4.26	12. F7.06	18. L1.17	24. W1.11	30.	36.	42.	48.

**ARCHITECTURAL REQUIREMENTS**

<b>WALL AND CEILING</b> Wall Material: <input type="text" value="ARGB 1.2m AFF, GB above"/> Finish: <input type="text" value="PT"/> Ceiling Material: <input type="text" value="ACT"/> Finish: <input type="text" value="PF"/>		<b>WALL PROTECTION</b> Type: <input type="text" value="PVW"/> <input checked="" type="checkbox"/> Corner Guards <input type="checkbox"/> Hand Rails <input type="checkbox"/> Bed Bumper / Locator Height: <input type="text" value="2185 mm"/> <input checked="" type="checkbox"/> Crash Rails <input type="checkbox"/> Chair Rail		<b>GLAZING</b> <input type="checkbox"/> Interior Glazing		<b>FLOORING TYPES</b> Material: <input type="text" value="VSF"/> Base: <input type="text" value="FCB"/>		<b>ROOM ACCESSORIES</b> <input type="checkbox"/> Coat Hooks <input type="checkbox"/> Ceiling Lift <input type="checkbox"/> Magnetic Whiteboard <input type="checkbox"/> Mirror <input type="checkbox"/> Infant Change Table <input type="checkbox"/> Privacy Curtain	
--	--	--	--	---	--	--	--	--	--

- LEGEND:**
- WALL AND CEILING LEGEND:**
- AC Architectural Ceiling
  - ACT Acoustic Ceiling Tile
  - ACT-C Cleanroom
  - ARGB Abuse-Resistant Gypsum Board
  - GB Gypsum Board
  - IRGB Impact-Resistant Gypsum Board
  - KLCT Kitchen Lay-in Ceiling Tile
  - MMRGB Moisture and Mould-Resistant Gypsum Board
  - SACT Security Acoustic Ceiling Tile
- WALL FINISHES LEGEND:**
- EWC Epoxy Wall Coating
  - HPC High Performance Coating
  - PT Paint
- CEILING FINISHES LEGEND:**
- ECC Epoxy Ceiling Coating
  - HPC High Performance Coating
  - PF Prefinished
  - PT Paint
- WALL PROTECTION LEGEND:**
- ESRP Extruded Semi-Rigid PVCu Panel
  - FRL Fibre Reinforced Laminate
  - FRP Fibreglass Reinforced Plastic
  - PVW Protective Vinyl Wallcovering
  - RHIS Rigid High Impact Sheet
  - WSSP Wetwall Solid Surface Panel
  - WVV Wetroom Vinyl Wallcovering
- FLOOR FINISHES LEGEND:**
- CFS Concrete Floor Sealer
  - EFC Epoxy Floor Coating
  - PFC Polyurethane Floor Coating
  - RAF Rubber Athletic Flooring
  - RSF Rubber Sheet Flooring
  - SCF Seamless Cushioned Flooring
  - SDRF Static-Dissipative Rubber Sheet Flooring
  - SDVF Static-Dissipative Vinyl Sheet Flooring
  - VSF Vinyl Sheet Flooring
  - WSVF Wetroom Safety Vinyl Sheet Flooring
- FLOOR BASE LEGEND:**
- FCB Flash Cove Base
  - RB Rubber Base
  - SCF Seamless Cushioned Flooring

**DOORS**

Types:

Type	Qty	Size (mm)	Material	Finish	Side Lt.	Blinds	Protect.	Film	Function	Card Reader	Mag Lock	Auto Opener	Hold Open	Hinges	Accessory 1	Accessory 2	Accessory 3	Closer
C	1	1220 x 2135	Solid Core	FRL	<input type="checkbox"/>	<input type="checkbox"/>	2 High	<input type="checkbox"/>	Storeroom	<input checked="" type="checkbox"/>	<input type="checkbox"/>	<input type="checkbox"/>	<input checked="" type="checkbox"/>	Cont. Swing Clear				Surface

Door Remarks:  Security Grille  Anti-barricade strategy

**MILLWORK AND SPECIALTY CASEWORK**

Storage Requirements:

**FINISHES**

Full-height Cabinet:   
 Upper Millwork:   
 Countertop:   
 Lower Millwork:   
 Shelf:

Remarks: Room W1.11 will require C2 type door. Door size to be 2440 x 2440 mm and will include an auto opener.

**MECHANICAL REQUIREMENTS**

<b>PLUMBING</b> (Quantity) Hygiene Sink: <input type="text"/> Lavatory: <input type="text"/> Kitchen Sink: <input type="text"/> Seamless Kitchen Sink: <input type="text"/> Utility / Process Sink: <input type="text"/> Scrub Sink: <input type="text"/> Floor Sink: <input type="text"/>							Other Fixtures: <input type="checkbox"/> Shower <input type="checkbox"/> Eyewash Station <input type="checkbox"/> Tub <input type="checkbox"/> Eyewash/Shower Station <input type="checkbox"/> Ice Maker <input type="checkbox"/> Emergency Shower <input type="checkbox"/> Water Closet <input type="checkbox"/> Flush Rim Sink <input type="checkbox"/> Instantaneous Hot Water <input type="checkbox"/> Floor Drain <input type="checkbox"/> Water Bottle Refill Station				<b>MED / NON-MED GASES</b> (Quantity) Oxygen: <input type="text"/> Medical Air: <input type="text"/> Medical Vacuum: <input type="text"/> Nitrous Oxide: <input type="text"/> CO2: <input type="text"/> AGSS: <input type="text"/> Nitrogen: <input type="text"/> Laboratory Air: <input type="text"/> Laboratory Vacuum: <input type="text"/> Utility Compressed Air: <input type="text"/>					
Plumbing Remarks: <input type="text"/>							Gas Remarks: <input type="text"/>									



**Appendix 1B Minimum Room Requirements**

Room Name:

Program Number(s):

1. B3.19	7.	13.	19.	25.	31.	37.	43.
2. C6.01	8.	14.	20.	26.	32.	38.	44.
3.	9.	15.	21.	27.	33.	39.	45.
4.	10.	16.	22.	28.	34.	40.	46.
5.	11.	17.	23.	29.	35.	41.	47.
6.	12.	18.	24.	30.	36.	42.	48.

**ARCHITECTURAL REQUIREMENTS**

<b>WALL AND CEILING</b> Wall Material: <input type="text" value="ARGB 1.2m AFF, GB above"/> Finish: <input type="text" value="PT"/> Ceiling Material: <input type="text" value="ACT"/> Finish: <input type="text" value="PF"/>		<b>WALL PROTECTION</b> Type: <input type="text" value="PVW"/> <input checked="" type="checkbox"/> Corner Guards <input type="checkbox"/> Hand Rails <input type="checkbox"/> Bed Bumper / Locator Height: <input type="text" value="2185 mm"/> <input type="checkbox"/> Crash Rails <input type="checkbox"/> Chair Rail		<b>GLAZING</b> <input type="checkbox"/> Interior Glazing		<b>FLOORING TYPES</b> Material: <input type="text" value="VSF"/> Base: <input type="text" value="FCB"/>		<b>ROOM ACCESSORIES</b> <input type="checkbox"/> Coat Hooks <input type="checkbox"/> Ceiling Lift <input type="checkbox"/> Magnetic Whiteboard <input type="checkbox"/> Mirror <input type="checkbox"/> Infant Change Table <input type="checkbox"/> Privacy Curtain	
--	--	---	--	---	--	--	--	--	--

- LEGEND:**
- WALL AND CEILING LEGEND:**
- AC Architectural Ceiling
  - ACT Acoustic Ceiling Tile
  - ACT-C Cleanroom
  - ARGB Abuse-Resistant Gypsum Board
  - GB Gypsum Board
  - IRGB Impact-Resistant Gypsum Board
  - KLCT Kitchen Lay-in Ceiling Tile
  - MMRGB Moisture and Mould-Resistant Gypsum Board
  - SACT Security Acoustic Ceiling Tile
- WALL FINISHES LEGEND:**
- EWC Epoxy Wall Coating
  - HPC High Performance Coating
  - PT Paint
- CEILING FINISHES LEGEND:**
- ECC Epoxy Ceiling Coating
  - HPC High Performance Coating
  - PF Prefinished
  - PT Paint
- WALL PROTECTION LEGEND:**
- ESRP Extruded Semi-Rigid PVCu Panel
  - FRL Fibre Reinforced Laminate
  - FRP Fibreglass Reinforced Plastic
  - PVW Protective Vinyl Wallcovering
  - RHIS Rigid High Impact Sheet
  - WSSP Wetwall Solid Surface Panel
  - WVV Wetroom Vinyl Wallcovering
- FLOOR FINISHES LEGEND:**
- CFS Concrete Floor Sealer
  - EFC Epoxy Floor Coating
  - PFC Polyurethane Floor Coating
  - RAF Rubber Athletic Flooring
  - RSF Rubber Sheet Flooring
  - SCF Seamless Cushioned Flooring
  - SDRF Static-Dissipative Rubber Sheet Flooring
  - SDVF Static-Dissipative Vinyl Sheet Flooring
  - VSF Vinyl Sheet Flooring
  - WSVF Wetroom Safety Vinyl Sheet Flooring
- FLOOR BASE LEGEND:**
- FCB Flash Cove Base
  - RB Rubber Base
  - SCF Seamless Cushioned Flooring

**DOORS**

Types:

Type	Qty	Size (mm)	Material	Finish	Side Lt.	Blinds	Protect.	Film	Function	Card Reader	Mag Lock	Auto Opener	Hold Open	Hinges	Accessory 1	Accessory 2	Accessory 3	Closer
C	1	1220 x 2135	Solid Core	FRL	<input type="checkbox"/>	<input type="checkbox"/>	2 High	<input type="checkbox"/>	Storeroom	<input checked="" type="checkbox"/>	<input type="checkbox"/>	<input type="checkbox"/>	<input checked="" type="checkbox"/>	Cont. Swing Clear				Surface

**DOOR REMARKS:**

Security Grille  
 Anti-barricade strategy



**MECHANICAL REQUIREMENTS**

<b>PLUMBING</b> (Quantity) Hand Hygiene Sink: <input type="text"/> Lavatory: <input type="text"/> Kitchen Sink: <input type="text"/> Seamless Kitchen Sink: <input type="text"/> Utility / Process Sink: <input type="text"/> Scrub Sink: <input type="text"/> Floor Sink: <input type="text"/>							Other Fixtures: <input type="checkbox"/> Shower <input type="checkbox"/> Eyewash Station <input type="checkbox"/> Tub <input type="checkbox"/> Eyewash/Shower Station <input type="checkbox"/> Ice Maker <input type="checkbox"/> Emergency Shower <input type="checkbox"/> Water Closet <input type="checkbox"/> Flush Rim Sink <input type="checkbox"/> Instantaneous Hot Water <input type="checkbox"/> Floor Drain <input type="checkbox"/> Water Bottle Refill Station Other: <input type="text"/>			<b>MED / NON-MED GASES</b> (Quantity) Oxygen: <input type="text"/> Medical Air: <input type="text"/> Medical Vacuum: <input type="text"/> Nitrous Oxide: <input type="text"/> CO2: <input type="text"/> AGSS: <input type="text"/> Nitrogen: <input type="text"/> Laboratory Air: <input type="text"/> Laboratory Vacuum: <input type="text"/> Utility Compressed Air: <input type="text"/>					
Plumbing Remarks: <input type="text"/>							Gas Remarks: <input type="text"/>								

**Appendix 1B Minimum Room Requirements**

Room Name:

Program Number(s):

1. C3.30	7.	13.	19.	25.	31.	37.	43.
2. D3.09	8.	14.	20.	26.	32.	38.	44.
3. G1.24	9.	15.	21.	27.	33.	39.	45.
4.	10.	16.	22.	28.	34.	40.	46.
5.	11.	17.	23.	29.	35.	41.	47.
6.	12.	18.	24.	30.	36.	42.	48.

**ARCHITECTURAL REQUIREMENTS**

<b>WALL AND CEILING</b> Wall Material: <input type="text" value="ARGB 1.2m AFF, GB above"/> Finish: <input type="text" value="PT"/> Ceiling Material: <input type="text" value="ACT"/> Finish: <input type="text" value="PF"/>	<b>WALL PROTECTION</b> Type: <input type="text" value="PVW"/> <input checked="" type="checkbox"/> Corner Guards <input type="checkbox"/> Hand Rails <input type="checkbox"/> Bed Bumper / Locator Height: <input type="text" value="2185 mm"/> <input type="checkbox"/> Crash Rails <input type="checkbox"/> Chair Rail	<b>GLAZING</b> <input type="checkbox"/> Interior Glazing	<b>FLOORING TYPES</b> Material: <input type="text" value="VSF"/> Base: <input type="text" value="FCB"/>	<b>ROOM ACCESSORIES</b> <input type="checkbox"/> Coat Hooks <input type="checkbox"/> Ceiling Lift <input checked="" type="checkbox"/> Magnetic Whiteboard <input type="checkbox"/> Mirror <input type="checkbox"/> Infant Change Table <input type="checkbox"/> Privacy Curtain
--	---	---	--	---

- LEGEND:**
- WALL AND CEILING LEGEND:**
- AC Architectural Ceiling
  - ACT Acoustic Ceiling Tile
  - ACT-C Cleanroom
  - ARGB Abuse-Resistant Gypsum Board
  - GB Gypsum Board
  - IRGB Impact-Resistant Gypsum Board
  - KLCT Kitchen Lay-in Ceiling Tile
  - MMRGB Moisture and Mould-Resistant Gypsum Board
  - SACT Security Acoustic Ceiling Tile
- WALL FINISHES LEGEND:**
- EWC Epoxy Wall Coating
  - HPC High Performance Coating
  - PT Paint
- CEILING FINISHES LEGEND:**
- ECC Epoxy Ceiling Coating
  - HPC High Performance Coating
  - PF Prefinished
  - PT Paint
- WALL PROTECTION LEGEND:**
- ESRP Extruded Semi-Rigid PVCu Panel
  - FRL Fibre Reinforced Laminate
  - FRP Fibreglass Reinforced Plastic
  - PVW Protective Vinyl Wallcovering
  - RHIS Rigid High Impact Sheet
  - WSSP Wetwall Solid Surface Panel
  - WVV Wetroom Vinyl Wallcovering
- FLOOR FINISHES LEGEND:**
- CFS Concrete Floor Sealer
  - EFC Epoxy Floor Coating
  - PFC Polyurethane Floor Coating
  - RAF Rubber Athletic Flooring
  - RSF Rubber Sheet Flooring
  - SCF Seamless Cushioned Flooring
  - SDRF Static-Dissipative Rubber Sheet Flooring
  - SDVF Static-Dissipative Vinyl Sheet Flooring
  - VSF Vinyl Sheet Flooring
  - WSVF Wetroom Safety Vinyl Sheet Flooring
- FLOOR BASE LEGEND:**
- FCB Flash Cove Base
  - RB Rubber Base
  - SCF Seamless Cushioned Flooring

**DOORS**

Types:

Type	Qty	Size (mm)	Material	Finish	Side Lt.	Blinds	Protect.	Privacy Film	Function	Card Reader	Mag Lock	Auto Opener	Hold Open	Hinges	Accessory 1	Accessory 2	Accessory 3	Closer
C	1	1220 x 2135	Solid Core	FRL	<input type="checkbox"/>	<input type="checkbox"/>	2 High	<input checked="" type="checkbox"/>	Storeroom	<input checked="" type="checkbox"/>	<input type="checkbox"/>	<input type="checkbox"/>	<input checked="" type="checkbox"/>	Cont. Swing Clear				Surface

Door Remarks:  Security Grille  Anti-barricade strategy



**MECHANICAL REQUIREMENTS**

<b>PLUMBING</b> (Quantity) Hand Hygiene Sink: <input type="text"/> Lavatory: <input type="text"/> Kitchen Sink: <input type="text"/> Seamless Kitchen Sink: <input type="text"/> Utility / Process Sink: <input type="text"/> Scrub Sink: <input type="text"/> Floor Sink: <input type="text"/> Plumbing Remarks: <input type="text"/>	Other Fixtures: <input type="checkbox"/> Shower <input type="checkbox"/> Eyewash Station <input type="checkbox"/> Tub <input type="checkbox"/> Eyewash/Shower Station <input type="checkbox"/> Ice Maker <input type="checkbox"/> Emergency Shower <input type="checkbox"/> Water Closet <input type="checkbox"/> Flush Rim Sink <input type="checkbox"/> Instantaneous Hot Water <input type="checkbox"/> Floor Drain <input type="checkbox"/> <input type="checkbox"/> Water Bottle Refill Station Other <input type="text"/>	<b>MED / NON-MED GASES</b> (Quantity) Oxygen: <input type="text"/> Medical Air: <input type="text"/> Medical Vacuum: <input type="text"/> Nitrous Oxide: <input type="text"/> CO2: <input type="text"/> AGSS: <input type="text"/> Nitrogen: <input type="text"/> Laboratory Air: <input type="text"/> Laboratory Vacuum: <input type="text"/> Utility Compressed Air: <input type="text"/> Gas Remarks: <input type="text"/>
---	--	---

**Appendix 1B Minimum Room Requirements**

Room Name:

Program Number(s):

1. A4.04	7. C6.02	13. F3.13	19. I2.18	25. M1.08	31. X3.02.05	37.	43.
2. A2.12	8. D2.28	14. F4.20	20. J4.04	26. M2.10	32.	38.	44.
3. B1.14	9. D6.18	15. F5.17	21. K3.14	27. M2.32	33.	39.	45.
4. B2.18	10. Not Used	16. F6.11	22. K4.10	28. P2.02	34.	40.	46.
5. B3.16	11. E2.05	17. G1.14	23. L1.15	29. U2.04	35.	41.	47.
6. C2.05	12. E6.02	18. H1.08	24. L2.14	30. W1.03	36.	42.	48.

**ARCHITECTURAL REQUIREMENTS**

<b>WALL AND CEILING</b> Wall Material: <input type="text" value="ARGB 1.2m AFF, GB above"/> Finish: <input type="text" value="EWC"/> Ceiling Material: <input type="text" value="ACT"/> Finish: <input type="text" value="PF"/>		<b>WALL PROTECTION</b> Type: <input type="text" value="PVW"/> <input checked="" type="checkbox"/> Corner Guards <input type="checkbox"/> Hand Rails <input type="checkbox"/> Bed Bumper / Locator Height: <input type="text" value="2185 mm"/> <input type="checkbox"/> Crash Rails <input type="checkbox"/> Chair Rail		<b>GLAZING</b> <input type="checkbox"/> Interior Glazing		<b>FLOORING TYPES</b> Material: <input type="text" value="VSF"/> Base: <input type="text" value="FCB"/>		<b>ROOM ACCESSORIES</b> <input type="checkbox"/> Coat Hooks <input type="checkbox"/> Ceiling Lift <input checked="" type="checkbox"/> Magnetic Whiteboard <input type="checkbox"/> Mirror <input type="checkbox"/> Infant Change Table <input type="checkbox"/> Privacy Curtain	
---	--	---	--	---	--	--	--	---	--

- LEGEND:**
- WALL AND CEILING LEGEND:**
- AC Architectural Ceiling
  - ACT Acoustic Ceiling Tile
  - ACT-C Cleanroom
  - ARGB Abuse-Resistant Gypsum Board
  - GB Gypsum Board
  - IRGB Impact-Resistant Gypsum Board
  - KLCT Kitchen Lay-in Ceiling Tile
  - MMRGB Moisture and Mould-Resistant Gypsum Board
  - SACT Security Acoustic Ceiling Tile
- WALL FINISHES LEGEND:**
- EWC Epoxy Wall Coating
  - HPC High Performance Coating
  - PT Paint
- CEILING FINISHES LEGEND:**
- ECC Epoxy Ceiling Coating
  - HPC High Performance Coating
  - PF Prefinished
  - PT Paint
- WALL PROTECTION LEGEND:**
- ESRP Extruded Semi-Rigid PVCu Panel
  - FRL Fibre Reinforced Laminate
  - FRP Fibreglass Reinforced Plastic
  - PVW Protective Vinyl Wallcovering
  - RHIS Rigid High Impact Sheet
  - WSSP Wetwall Solid Surface Panel
  - WVV Wetroom Vinyl Wallcovering
- FLOOR FINISHES LEGEND:**
- CFS Concrete Floor Sealer
  - EFC Epoxy Floor Coating
  - PFC Polyurethane Floor Coating
  - RAF Rubber Athletic Flooring
  - RSF Rubber Sheet Flooring
  - SCF Seamless Cushioned Flooring
  - SDRF Static-Dissipative Rubber Sheet Flooring
  - SDVF Static-Dissipative Vinyl Sheet Flooring
  - VSF Vinyl Sheet Flooring
  - WSVF Wetroom Safety Vinyl Sheet Flooring
- FLOOR BASE LEGEND:**
- FCB Flash Cove Base
  - RB Rubber Base
  - SCF Seamless Cushioned Flooring

**DOORS**

Types:

Type	Qty	Size (mm)	Material	Finish	Side Lt	Blinds	Protect	Privacy Film	Function	Card Reader	Mag Lock	Auto Opener	Hold Open	Hinges	Accessory 1	Accessory 2	Accessory 3	Closer
C	1	1220 x 2135	Solid Core	FRL	<input type="checkbox"/>	<input type="checkbox"/>	2 High	<input type="checkbox"/>	Storeroom	<input checked="" type="checkbox"/>	<input type="checkbox"/>	<input type="checkbox"/>	<input checked="" type="checkbox"/>	Cont. Swing Clear				Surface

Door Remarks:  Security Grille  Anti-barricade strategy

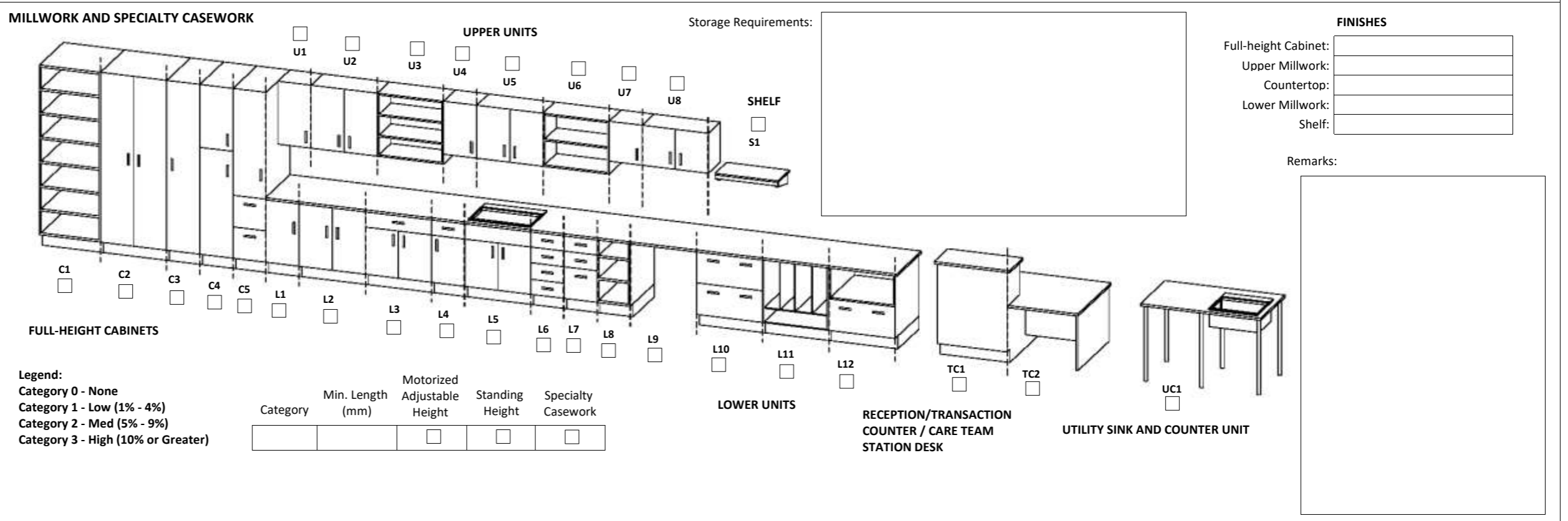

**MECHANICAL REQUIREMENTS**

<b>PLUMBING</b> (Quantity) Hygiene Sink: <input type="text"/> Lavatory: <input type="text"/> Kitchen Sink: <input type="text"/> Seamless Kitchen Sink: <input type="text"/> Utility / Process Sink: <input type="text"/> Scrub Sink: <input type="text"/> Floor Sink: <input type="text"/>		Other Fixtures: <input type="checkbox"/> Shower <input type="checkbox"/> Eyewash Station <input type="checkbox"/> Tub <input type="checkbox"/> Eyewash/Shower Station <input type="checkbox"/> Ice Maker <input type="checkbox"/> Emergency Shower <input type="checkbox"/> Water Closet <input type="checkbox"/> Flush Rim Sink <input type="checkbox"/> Instantaneous Hot Water <input type="checkbox"/> Floor Drain <input type="checkbox"/> Water Bottle Refill Station Other: <input type="text"/>		<b>MED / NON-MED GASES</b> (Quantity) Oxygen: <input type="text"/> Medical Air: <input type="text"/> Medical Vacuum: <input type="text"/> Nitrous Oxide: <input type="text"/> CO2: <input type="text"/> AGSS: <input type="text"/> Nitrogen: <input type="text"/> Laboratory Air: <input type="text"/> Laboratory Vacuum: <input type="text"/> Utility Compressed Air: <input type="text"/>	
Plumbing Remarks: <input type="text"/>		Gas Remarks: <input type="text"/>			



**Appendix 1B Minimum Room Requirements**

Room Name:

Program Number(s):

1. H1.07	7.	13.	19.	25.	31.	37.	43.
2. M1.06	8.	14.	20.	26.	32.	38.	44.
3. U5.03	9.	15.	21.	27.	33.	39.	45.
4. U5.09	10.	16.	22.	28.	34.	40.	46.
5.	11.	17.	23.	29.	35.	41.	47.
6.	12.	18.	24.	30.	36.	42.	48.

**ARCHITECTURAL REQUIREMENTS**

<b>WALL AND CEILING</b> Wall Material: <input type="text" value="ARGB 1.2m AFF, GB above"/> Finish: <input type="text" value="PT"/> Ceiling Material: <input type="text" value="ACT"/> Finish: <input type="text" value="PF"/>	<b>WALL PROTECTION</b> Type: <input type="text" value="PVW"/> <input checked="" type="checkbox"/> Corner Guards <input type="checkbox"/> Hand Rails <input type="checkbox"/> Bed Bumper / Locator Height: <input type="text" value="1350 mm"/> <input type="checkbox"/> Crash Rails <input type="checkbox"/> Chair Rail	<b>GLAZING</b> <input type="checkbox"/> Interior Glazing	<b>FLOORING TYPES</b> Material: <input type="text" value="VSF"/> Base: <input type="text" value="FCB"/>	<b>ROOM ACCESSORIES</b> <input type="checkbox"/> Coat Hooks <input type="checkbox"/> Ceiling Lift <input type="checkbox"/> Magnetic Whiteboard <input type="checkbox"/> Mirror <input type="checkbox"/> Infant Change Table <input type="checkbox"/> Privacy Curtain
--	---	---	--	--

- LEGEND:**
- WALL AND CEILING LEGEND:**
- AC Architectural Ceiling
  - ACT Acoustic Ceiling Tile
  - ACT-C Cleanroom
  - ARGB Abuse-Resistant Gypsum Board
  - GB Gypsum Board
  - IRGB Impact-Resistant Gypsum Board
  - KLCT Kitchen Lay-in Ceiling Tile
  - MMRGB Moisture and Mould-Resistant Gypsum Board
  - SACT Security Acoustic Ceiling Tile
- WALL FINISHES LEGEND:**
- EWC Epoxy Wall Coating
  - HPC High Performance Coating
  - PT Paint
- CEILING FINISHES LEGEND:**
- ECC Epoxy Ceiling Coating
  - HPC High Performance Coating
  - PF Prefinished
  - PT Paint
- WALL PROTECTION LEGEND:**
- ESRP Extruded Semi-Rigid PVCu Panel
  - FRL Fibre Reinforced Laminate
  - FRP Fibreglass Reinforced Plastic
  - PVW Protective Vinyl Wallcovering
  - RHIS Rigid High Impact Sheet
  - WSSP Wetwall Solid Surface Panel
  - WVV Wetroom Vinyl Wallcovering
- FLOOR FINISHES LEGEND:**
- CFS Concrete Floor Sealer
  - EFC Epoxy Floor Coating
  - PFC Polyurethane Floor Coating
  - RAF Rubber Athletic Flooring
  - RSF Rubber Sheet Flooring
  - SCF Seamless Cushioned Flooring
  - SDRF Static-Dissipative Rubber Sheet Flooring
  - SDVF Static-Dissipative Vinyl Sheet Flooring
  - VSF Vinyl Sheet Flooring
  - WSVF Wetroom Safety Vinyl Sheet Flooring
- FLOOR BASE LEGEND:**
- FCB Flash Cove Base
  - RB Rubber Base
  - SCF Seamless Cushioned Flooring

**DOORS**

Types:

Type	Qty	Size (mm)	Material	Finish	Side Lt.	Blinds	Protect.	Privacy Film	Function	Card Reader	Mag Lock	Auto Opener	Hold Open	Hinges	Accessory 1	Accessory 2	Accessory 3	Closer
C	1	915 x 2135	Solid Core	FRL	<input type="checkbox"/>	<input type="checkbox"/>	2 High	<input type="checkbox"/>	Storeroom	<input checked="" type="checkbox"/>	<input type="checkbox"/>	<input type="checkbox"/>	<input type="checkbox"/>	Cont. Swing Clear				Surface

**DOOR REMARKS:**

Security Grille  
 Anti-barricade strategy



**MECHANICAL REQUIREMENTS**

<b>PLUMBING</b> (Quantity) Hand Hygiene Sink: <input type="text"/> Lavatory: <input type="text"/> Kitchen Sink: <input type="text"/> Seamless Kitchen Sink: <input type="text"/> Utility / Process Sink: <input type="text"/> Scrub Sink: <input type="text"/> Floor Sink: <input type="text"/> Plumbing Remarks: <input type="text"/>	Other Fixtures: <input type="checkbox"/> Shower <input type="checkbox"/> Tub <input type="checkbox"/> Ice Maker <input type="checkbox"/> Water Closet <input type="checkbox"/> Instantaneous Hot Water <input type="checkbox"/> Eyewash Station <input type="checkbox"/> Eyewash/Shower Station <input type="checkbox"/> Emergency Shower <input type="checkbox"/> Flush Rim Sink <input type="checkbox"/> Floor Drain <input type="checkbox"/> Water Bottle Refill Station Other: <input type="text"/>	<b>MED / NON-MED GASES</b> (Quantity) Oxygen: <input type="text"/> Medical Air: <input type="text"/> Medical Vacuum: <input type="text"/> Nitrous Oxide: <input type="text"/> CO2: <input type="text"/> AGSS: <input type="text"/> Nitrogen: <input type="text"/> Laboratory Air: <input type="text"/> Laboratory Vacuum: <input type="text"/> Utility Compressed Air: <input type="text"/> Gas Remarks: <input type="text"/>
---	---	---

**Appendix 1B Minimum Room Requirements**

Room Name:

Program Number(s):

1. C2.03	7. L2.01	13.	19.	25.	31.	37.	43.
2. C7.02	8. M2.09	14.	20.	26.	32.	38.	44.
3. F3.04	9.	15.	21.	27.	33.	39.	45.
4. F4.05	10.	16.	22.	28.	34.	40.	46.
5. F5.08	11.	17.	23.	29.	35.	41.	47.
6. K4.02	12.	18.	24.	30.	36.	42.	48.

**ARCHITECTURAL REQUIREMENTS**

<b>WALL AND CEILING</b> Wall Material: <input type="text" value="ARGB 1.2m AFF, GB above"/> Finish: <input type="text" value="PT"/> Ceiling Material: <input type="text" value="ACT"/> Finish: <input type="text" value="PF"/>		<b>WALL PROTECTION</b> Type: <input type="text" value="ESRP"/> <input checked="" type="checkbox"/> Corner Guards <input type="checkbox"/> Hand Rails <input checked="" type="checkbox"/> Bed Bumper / Locator Height: <input type="text" value="1600 mm"/> <input checked="" type="checkbox"/> Crash Rails <input type="checkbox"/> Chair Rail		<b>GLAZING</b> <input type="checkbox"/> Interior Glazing		<b>FLOORING TYPES</b> Material: <input type="text" value="VSF"/> Base: <input type="text" value="FCB"/>		<b>ROOM ACCESSORIES</b> <input type="checkbox"/> Coat Hooks <input checked="" type="checkbox"/> Ceiling Lift <input checked="" type="checkbox"/> Magnetic Whiteboard <input type="checkbox"/> Mirror <input type="checkbox"/> Infant Change Table <input checked="" type="checkbox"/> Privacy Curtain	
--	--	--	--	---	--	--	--	---	--

- LEGEND:**
- WALL AND CEILING LEGEND:**
- AC Architectural Ceiling
  - ACT Acoustic Ceiling Tile
  - ACT-C Cleanroom
  - ARGB Abuse-Resistant Gypsum Board
  - GB Gypsum Board
  - IRGB Impact-Resistant Gypsum Board
  - KLCT Kitchen Lay-in Ceiling Tile
  - MMRGB Moisture and Mould-Resistant Gypsum Board
  - SACT Security Acoustic Ceiling Tile
- WALL FINISHES LEGEND:**
- EWC Epoxy Wall Coating
  - HPC High Performance Coating
  - PT Paint
- CEILING FINISHES LEGEND:**
- ECC Epoxy Ceiling Coating
  - HPC High Performance Coating
  - PF Prefinished
  - PT Paint
- WALL PROTECTION LEGEND:**
- ESRP Extruded Semi-Rigid PVCu Panel
  - FRL Fibre Reinforced Laminate
  - FRP Fibreglass Reinforced Plastic
  - PVV Protective Vinyl Wallcovering
  - RHIS Rigid High Impact Sheet
  - WSSP Wetwall Solid Surface Panel
  - WVV Wetroom Vinyl Wallcovering
- FLOOR FINISHES LEGEND:**
- CFS Concrete Floor Sealer
  - EFC Epoxy Floor Coating
  - PFC Polyurethane Floor Coating
  - RAF Rubber Athletic Flooring
  - RSF Rubber Sheet Flooring
  - SCF Seamless Cushioned Flooring
  - SDRF Static-Dissipative Rubber Sheet Flooring
  - SDVF Static-Dissipative Vinyl Sheet Flooring
  - VSF Vinyl Sheet Flooring
  - WSVF Wetroom Safety Vinyl Sheet Flooring
- FLOOR BASE LEGEND:**
- FCB Flash Cove Base
  - RB Rubber Base
  - SCF Seamless Cushioned Flooring

**DOORS**

Types:

Type	Qty	Size (mm)	Material	Finish	Side Lt.	Blinds	Protect.	Privacy Film	Function	Card Reader	Mag Lock	Auto Opener	Hold Open	Hinges	Accessory 1	Accessory 2	Accessory 3	Closer

Door Remarks:  Security Grille  Anti-barricade strategy

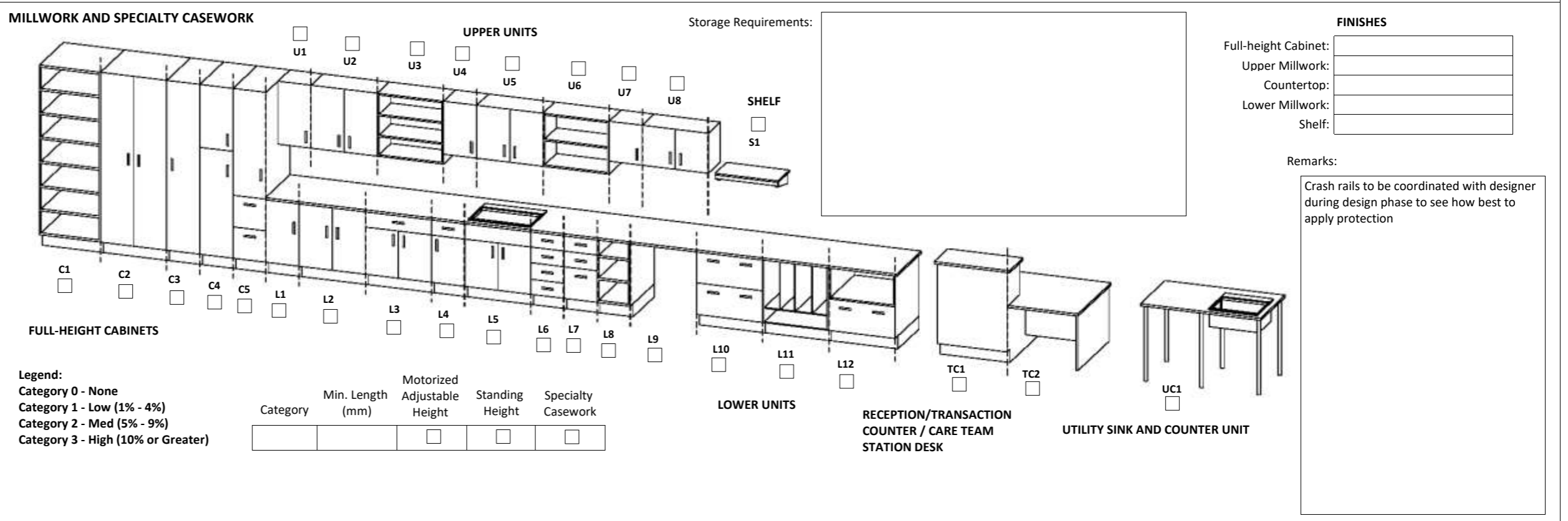

**MECHANICAL REQUIREMENTS**

<b>PLUMBING</b> (Quantity)		Hand Hygiene Sink: <input type="text" value="1"/>		Lavatory: <input type="text"/>		Kitchen Sink: <input type="text"/>		Seamless Kitchen Sink: <input type="text"/>		Utility / Process Sink: <input type="text"/>		Scrub Sink: <input type="text"/>		Floor Sink: <input type="text"/>		Other Fixtures:		<b>MED / NON-MED GASES</b> (Quantity)							
Plumbing Remarks:		C2.03 - Provide (1) HHS to serve (4) stretcher bays. (1 total) F3.04 - Provide (1) HHS per every (2) stretcher bays. (2 total) F4.05 - Provide (1) HHS per (2) stretcher bays (1 total) F5.08 - Provide (1) HHS per (2) stretcher bays (2 total) L2.01 - Provide (1) HHS per (2) stretcher bays. (3 total) M2.09 - Provide (1) HHS per (2) stretcher bays (1 total)		<input type="checkbox"/> Shower <input type="checkbox"/> Eyewash Station <input type="checkbox"/> Tub <input type="checkbox"/> Eyewash/Shower Station <input type="checkbox"/> Ice Maker <input type="checkbox"/> Emergency Shower <input type="checkbox"/> Water Closet <input type="checkbox"/> Flush Rim Sink <input type="checkbox"/> Instantaneous Hot Water <input type="checkbox"/> Floor Drain <input type="checkbox"/> Water Bottle Refill Station		Oxygen: <input type="text" value="1"/>		Medical Air: <input type="text" value="1"/>		Medical Vacuum: <input type="text" value="1"/>		Nitrous Oxide: <input type="text"/>		CO2: <input type="text"/>		AGSS: <input type="text"/>		Nitrogen: <input type="text"/>		Laboratory Air: <input type="text"/>		Laboratory Vacuum: <input type="text"/>		Utility Compressed Air: <input type="text"/>	
Gas Remarks:		Provide (1) set of gases ((1) O2, (1) Medical Air, (1) Medical Vacuum) per bay to Patient's right. Stretcher Bay L2.01 and K4.02 does not require Medical Vacuum																							

**Appendix 1B Minimum Room Requirements**

Room Name:

Program Number(s):

1.	12.05	7.	13.	19.	25.	31.	37.	43.
2.		8.	14.	20.	26.	32.	38.	44.
3.		9.	15.	21.	27.	33.	39.	45.
4.		10.	16.	22.	28.	34.	40.	46.
5.		11.	17.	23.	29.	35.	41.	47.
6.		12.	18.	24.	30.	36.	42.	48.

**ARCHITECTURAL REQUIREMENTS**

<b>WALL AND CEILING</b> Wall Material: <input type="text" value="ARGB 1.2m AFF, GB above"/> Finish: <input type="text" value="PT"/> Ceiling Material: <input type="text" value="ACT"/> Finish: <input type="text" value="PF"/>		<b>WALL PROTECTION</b> Type: <input type="text" value="ESRP"/> <input type="checkbox"/> Corner Guards <input type="checkbox"/> Hand Rails <input checked="" type="checkbox"/> Bed Bumper / Locator Height: <input type="text" value="1600 mm"/> <input checked="" type="checkbox"/> Crash Rails <input type="checkbox"/> Chair Rail		<b>GLAZING</b> <input type="checkbox"/> Interior Glazing		<b>FLOORING TYPES</b> Material: <input type="text" value="VSF"/> Base: <input type="text" value="FCB"/>		<b>ROOM ACCESSORIES</b> <input type="checkbox"/> Coat Hooks <input checked="" type="checkbox"/> Ceiling Lift <input checked="" type="checkbox"/> Magnetic Whiteboard <input type="checkbox"/> Mirror <input type="checkbox"/> Infant Change Table <input checked="" type="checkbox"/> Privacy Curtain	
--	--	---	--	---	--	--	--	---	--

- LEGEND:**
- WALL AND CEILING LEGEND:**
- AC Architectural Ceiling
  - ACT Acoustic Ceiling Tile
  - ACT-C Cleanroom
  - ARGB Abuse-Resistant Gypsum Board
  - GB Gypsum Board
  - IRGB Impact-Resistant Gypsum Board
  - KLCT Kitchen Lay-in Ceiling Tile
  - MMRGB Moisture and Mould-Resistant Gypsum Board
  - SACT Security Acoustic Ceiling Tile
- WALL FINISHES LEGEND:**
- EWC Epoxy Wall Coating
  - HPC High Performance Coating
  - PT Paint
- CEILING FINISHES LEGEND:**
- ECC Epoxy Ceiling Coating
  - HPC High Performance Coating
  - PF Prefinished
  - PT Paint
- WALL PROTECTION LEGEND:**
- ESRP Extruded Semi-Rigid PVCu Panel
  - FRL Fibre Reinforced Laminate
  - FRP Fibreglass Reinforced Plastic
  - PVV Protective Vinyl Wallcovering
  - RHIS Rigid High Impact Sheet
  - WSSP Wetwall Solid Surface Panel
  - WVV Wetroom Vinyl Wallcovering
- FLOOR FINISHES LEGEND:**
- CFS Concrete Floor Sealer
  - EFC Epoxy Floor Coating
  - PFC Polyurethane Floor Coating
  - RAF Rubber Athletic Flooring
  - RSF Rubber Sheet Flooring
  - SCF Seamless Cushioned Flooring
  - SDRF Static-Dissipative Rubber Sheet Flooring
  - SDVF Static-Dissipative Vinyl Sheet Flooring
  - VSF Vinyl Sheet Flooring
  - WSVF Wetroom Safety Vinyl Sheet Flooring
- FLOOR BASE LEGEND:**
- FCB Flash Cove Base
  - RB Rubber Base
  - SCF Seamless Cushioned Flooring

**DOORS**

Types:

Type	Qty	Size (mm)	Material	Finish	Side Lt.	Blinds	Protect.	Privacy Film	Function	Card Reader	Mag Lock	Auto Opener	Hold Open	Hinges	Accessory 1	Accessory 2	Accessory 3	Closer	

Door Remarks:  Security Grille  Anti-barricade strategy

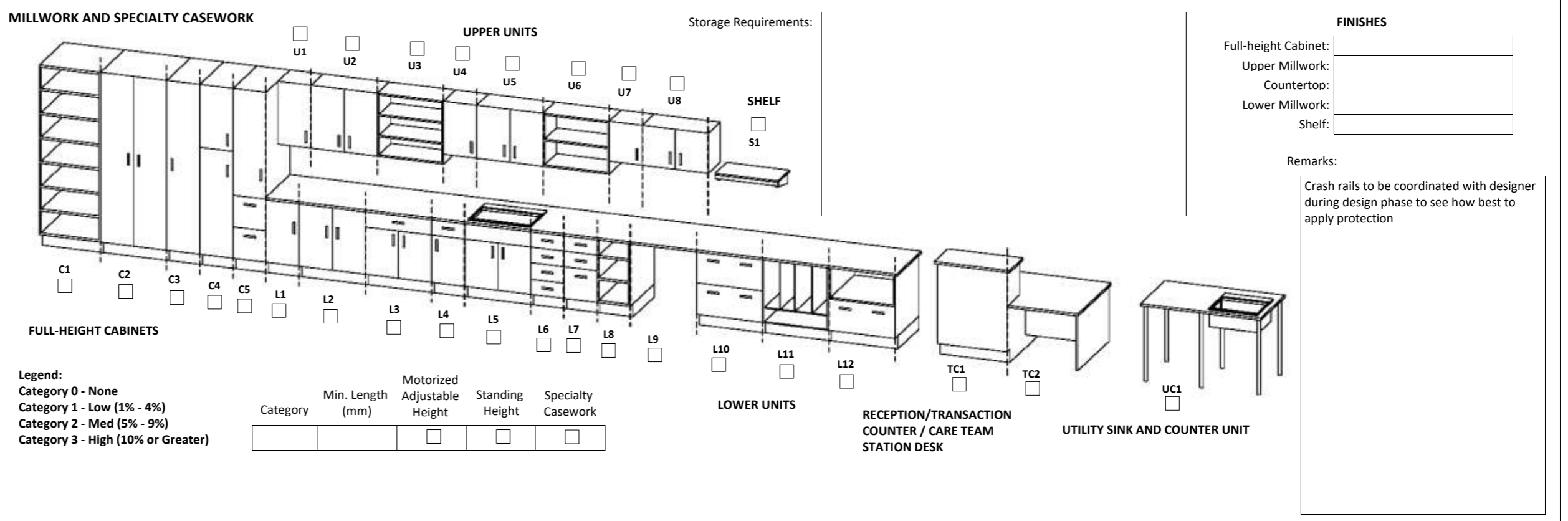

**MECHANICAL REQUIREMENTS**

<b>PLUMBING</b> (Quantity) Hygiene Sink: <input type="text"/> Lavatory: <input type="text"/> Kitchen Sink: <input type="text"/> Kitchen Sink: <input type="text"/> Utility / Process Sink: <input type="text"/> Scrub Sink: <input type="text"/> Floor Sink: <input type="text"/>							Other Fixtures: <input type="checkbox"/> Shower <input type="checkbox"/> Eyewash Station <input type="checkbox"/> Tub <input type="checkbox"/> Eyewash/Shower Station <input type="checkbox"/> Ice Maker <input type="checkbox"/> Emergency Shower <input type="checkbox"/> Water Closet <input type="checkbox"/> Flush Rim Sink <input type="checkbox"/> Instantaneous Hot Water <input type="checkbox"/> Floor Drain <input type="checkbox"/> <input type="checkbox"/> Water Bottle Refill Station Other <input type="text"/>				<b>MED / NON-MED GASES</b> (Quantity) Oxygen: <input type="text" value="2"/> Medical Air: <input type="text" value="2"/> Medical Vacuum: <input type="text" value="2"/> Nitrous Oxide: <input type="text"/> CO2: <input type="text"/> AGSS: <input type="text"/> Nitrogen: <input type="text"/> Laboratory Air: <input type="text"/> Laboratory Vacuum: <input type="text"/> Utility Compressed Air: <input type="text"/>					
Plumbing Remarks: <input type="text" value="Provide (2) HHS per treatment pod cluster"/>							Gas Remarks: <input type="text" value="Provide one set of gases ((1) O2, (1) Medical Air, (1) Medical Vacuum) per on each side of the bed."/>									



**Appendix 1B Minimum Room Requirements**

Room Name:

Program Number(s):

1. F4.06	7.	13.	19.	25.	31.	37.	43.
2. F6.08	8.	14.	20.	26.	32.	38.	44.
3. F7.02	9.	15.	21.	27.	33.	39.	45.
4. K4.07	10.	16.	22.	28.	34.	40.	46.
5.	11.	17.	23.	29.	35.	41.	47.
6.	12.	18.	24.	30.	36.	42.	48.

**ARCHITECTURAL REQUIREMENTS**

<b>WALL AND CEILING</b> Wall Material: <input type="text" value="ARGB 1.2m AFF, GB above"/> Finish: <input type="text" value="PT"/> Ceiling Material: <input type="text" value="ACT"/> Finish: <input type="text" value="PF"/>		<b>WALL PROTECTION</b> Type: <input type="text" value="ESRP"/> <input checked="" type="checkbox"/> Corner Guards <input type="checkbox"/> Hand Rails <input checked="" type="checkbox"/> Bed Bumper / Locator Height: <input type="text" value="1600 mm"/> <input checked="" type="checkbox"/> Crash Rails <input type="checkbox"/> Chair Rail		<b>GLAZING</b> <input type="checkbox"/> Interior Glazing		<b>FLOORING TYPES</b> Material: <input type="text" value="VSF"/> Base: <input type="text" value="FCB"/>		<b>ROOM ACCESSORIES</b> <input type="checkbox"/> Coat Hooks <input checked="" type="checkbox"/> Ceiling Lift <input checked="" type="checkbox"/> Magnetic Whiteboard <input type="checkbox"/> Mirror <input type="checkbox"/> Infant Change Table <input checked="" type="checkbox"/> Privacy Curtain	
--	--	--	--	---	--	--	--	---	--

- LEGEND:**
- WALL AND CEILING LEGEND:**
- AC Architectural Ceiling
  - ACT Acoustic Ceiling Tile
  - ACT-C Cleanroom
  - ARGB Abuse-Resistant Gypsum Board
  - GB Gypsum Board
  - IRGB Impact-Resistant Gypsum Board
  - KLCT Kitchen Lay-in Ceiling Tile
  - MMRGB Moisture and Mould-Resistant Gypsum Board
  - SACT Security Acoustic Ceiling Tile
- WALL FINISHES LEGEND:**
- EWC Epoxy Wall Coating
  - HPC High Performance Coating
  - PT Paint
- CEILING FINISHES LEGEND:**
- ECC Epoxy Ceiling Coating
  - HPC High Performance Coating
  - PF Prefinished
  - PT Paint
- WALL PROTECTION LEGEND:**
- ESRP Extruded Semi-Rigid PVCu Panel
  - FRL Fibre Reinforced Laminate
  - FRP Fibreglass Reinforced Plastic
  - PVV Protective Vinyl Wallcovering
  - RHIS Rigid High Impact Sheet
  - WSSP Wetwall Solid Surface Panel
  - WVV Wetroom Vinyl Wallcovering
- FLOOR FINISHES LEGEND:**
- CFS Concrete Floor Sealer
  - EFC Epoxy Floor Coating
  - PFC Polyurethane Floor Coating
  - RAF Rubber Athletic Flooring
  - RSF Rubber Sheet Flooring
  - SCF Seamless Cushioned Flooring
  - SDRF Static-Dissipative Rubber Sheet Flooring
  - SDVF Static-Dissipative Vinyl Sheet Flooring
  - VSF Vinyl Sheet Flooring
  - WSVF Wetroom Safety Vinyl Sheet Flooring
- FLOOR BASE LEGEND:**
- FCB Flash Cove Base
  - RB Rubber Base
  - SCF Seamless Cushioned Flooring

**DOORS**

Types:

Type:Qty:	Size (mm):	Material:	Finish:	Side Lt:	Blinds:	Protect.:	Privacy Film:	Function:	Card Reader:	Mag Lock:	Auto Opener:	Hold Open:	Hinges:	Accessory 1:	Accessory 2:	Accessory 3:	Closer:

Door Remarks:  Security Grille  Anti-barricade strategy



**MECHANICAL REQUIREMENTS**

<b>PLUMBING</b> (Quantity) <table border="1"> <tr> <th>Hand Hygiene Sink:</th> <th>Lavatory:</th> <th>Kitchen Sink:</th> <th>Seamless Kitchen Sink:</th> <th>Utility / Process Sink:</th> <th>Scrub Sink:</th> <th>Floor Sink:</th> </tr> <tr> <td>1</td> <td></td> <td></td> <td></td> <td></td> <td></td> <td></td> </tr> </table>		Hand Hygiene Sink:	Lavatory:	Kitchen Sink:	Seamless Kitchen Sink:	Utility / Process Sink:	Scrub Sink:	Floor Sink:	1							Other Fixtures: <input type="checkbox"/> Shower <input type="checkbox"/> Eyewash Station <input type="checkbox"/> Tub <input type="checkbox"/> Eyewash/Shower Station <input type="checkbox"/> Ice Maker <input type="checkbox"/> Emergency Shower <input type="checkbox"/> Water Closet <input type="checkbox"/> Flush Rim Sink <input type="checkbox"/> Instantaneous Hot Water <input type="checkbox"/> Floor Drain <input type="checkbox"/> <input type="checkbox"/> Water Bottle Refill Station Other: <input type="text"/>		<b>MED / NON-MED GASES</b> (Quantity) <table border="1"> <tr> <th>Oxygen:</th> <th>Medical Air:</th> <th>Medical Vacuum:</th> <th>Nitrous Oxide:</th> <th>CO2:</th> <th>AGSS:</th> <th>Nitrogen:</th> <th>Laboratory Air:</th> <th>Laboratory Vacuum:</th> <th>Utility Compressed Air:</th> </tr> <tr> <td>1</td> <td>1</td> <td>1</td> <td></td> <td></td> <td></td> <td></td> <td></td> <td></td> <td></td> </tr> </table>		Oxygen:	Medical Air:	Medical Vacuum:	Nitrous Oxide:	CO2:	AGSS:	Nitrogen:	Laboratory Air:	Laboratory Vacuum:	Utility Compressed Air:	1	1	1							
Hand Hygiene Sink:	Lavatory:	Kitchen Sink:	Seamless Kitchen Sink:	Utility / Process Sink:	Scrub Sink:	Floor Sink:																																	
1																																							
Oxygen:	Medical Air:	Medical Vacuum:	Nitrous Oxide:	CO2:	AGSS:	Nitrogen:	Laboratory Air:	Laboratory Vacuum:	Utility Compressed Air:																														
1	1	1																																					
Plumbing Remarks: F4.06 - Provide (1) HHS F6.08 - Provide (1) HHS to be shared with 2 bays. F7.02 - Provide (1) HHS to be shared with 3 bays. K4.07 - Provide (1) HHS.		Gas Remarks: Provide one set of gases ((1) O2, (1) Medical Air, (1) Medical Vacuum) per bay to Patient's right. Stretcher Bay K4.07 does not require Medical Vacuum																																					

**Appendix 1B Minimum Room Requirements**

Room Name:

Program Number(s):

1. A1.03	7. F2.01	13. I1.02	19. U1.02	25.	31.	37.	43.
2. C1.04	8. F3.01	14. K3.01	20.	26.	32.	38.	44.
3. C7.01	9. F4.01	15. K4.01	21.	27.	33.	39.	45.
4. D1.03	10. F5.01	16. M2.01	22.	28.	34.	40.	46.
5. E8.03	11. G1.01	17. T1.02.08	23.	29.	35.	41.	47.
6. F1.04	12. L1.01	18. T2.01.02	24.	30.	36.	42.	48.

**ARCHITECTURAL REQUIREMENTS**

<b>WALL AND CEILING</b> Wall Material: <input type="text" value="ARGB 1.2m AFF, GB above"/> Finish: <input type="text" value="PT"/> Ceiling Material: <input type="text" value="ACT"/> Finish: <input type="text" value="PF"/>		<b>WALL PROTECTION</b> Type: <input type="text" value="FRL"/> <input type="checkbox"/> Corner Guards <input type="checkbox"/> Hand Rails <input type="checkbox"/> Bed Bumper / Locator Height: <input type="text" value="1350 mm"/> <input type="checkbox"/> Crash Rails <input checked="" type="checkbox"/> Chair Rail			<b>GLAZING</b> <input checked="" type="checkbox"/> Interior Glazing		<b>FLOORING TYPES</b> Material: <input type="text" value="VSF"/> Base: <input type="text" value="FCB"/>		<b>ROOM ACCESSORIES</b> <input type="checkbox"/> Coat Hooks <input type="checkbox"/> Ceiling Lift <input type="checkbox"/> Magnetic Whiteboard <input type="checkbox"/> Mirror <input type="checkbox"/> Infant Change Table <input type="checkbox"/> Privacy Curtain		
--	--	---	--	--	--	--	--	--	--	--	--

- LEGEND:**
- WALL AND CEILING LEGEND:**
- AC Architectural Ceiling
  - ACT Acoustic Ceiling Tile
  - ACT-C Cleanroom
  - ARGB Abuse-Resistant Gypsum Board
  - GB Gypsum Board
  - IRGB Impact-Resistant Gypsum Board
  - KLCT Kitchen Lay-in Ceiling Tile
  - MMRGB Moisture and Mould-Resistant Gypsum Board
  - SACT Security Acoustic Ceiling Tile
- WALL FINISHES LEGEND:**
- EWC Epoxy Wall Coating
  - HPC High Performance Coating
  - PT Paint
- CEILING FINISHES LEGEND:**
- ECC Epoxy Ceiling Coating
  - HPC High Performance Coating
  - PF Prefinished
  - PT Paint
- WALL PROTECTION LEGEND:**
- ESRP Extruded Semi-Rigid PVCu Panel
  - FRL Fibre Reinforced Laminate
  - FRP Fibreglass Reinforced Plastic
  - PVV Protective Vinyl Wallcovering
  - RHIS Rigid High Impact Sheet
  - WSSP Wetwall Solid Surface Panel
  - WVV Wetroom Vinyl Wallcovering
- FLOOR FINISHES LEGEND:**
- CFS Concrete Floor Sealer
  - EFC Epoxy Floor Coating
  - PFC Polyurethane Floor Coating
  - RAF Rubber Athletic Flooring
  - RSF Rubber Sheet Flooring
  - SCF Seamless Cushioned Flooring
  - SDRF Static-Dissipative Rubber Sheet Flooring
  - SDVF Static-Dissipative Vinyl Sheet Flooring
  - VSF Vinyl Sheet Flooring
  - WSVF Wetroom Safety Vinyl Sheet Flooring
- FLOOR BASE LEGEND:**
- FCB Flash Cove Base
  - RB Rubber Base
  - SCF Seamless Cushioned Flooring

**DOORS**

Types:

Type	Qty	Size (mm)	Material	Finish	Side Lt.	Blinds	Protect.	Privacy Film	Function	Card Reader	Mag Lock	Auto Opener	Hold Open	Hinges	Accessory 1	Accessory 2	Accessory 3	Closer	

Door Remarks:

Security Grille  
 Anti-barricade strategy

**MILLWORK AND SPECIALTY CASEWORK**

Storage Requirements:

**UPPER UNITS** (U1-U8)

**LOWER UNITS** (L1-L12)

**RECEPTION/TRANSACTION COUNTER / CARE TEAM STATION DESK** (TC1, TC2)

**UTILITY SINK AND COUNTER UNIT** (UC1)

**SHELF** (S1)

**FULL-HEIGHT CABINETS** (C1-C5)

**Legend:**

Category	Min. Length (mm)	Motorized Adjustable Height	Standing Height	Specialty Casework
Category 0 - None				
Category 1 - Low (1% - 4%)				
Category 2 - Med (5% - 9%)				
Category 3 - High (10% or Greater)				

**FINISHES**

Full-height Cabinet:

Upper Millwork:

Countertop:

Lower Millwork:

Shelf:

Remarks:

**MECHANICAL REQUIREMENTS**

<b>PLUMBING</b> (Quantity) Hand Hygiene Sink: <input type="text"/> Lavatory: <input type="text"/> Kitchen Sink: <input type="text"/> Seamless Kitchen Sink: <input type="text"/> Utility / Process Sink: <input type="text"/> Scrub Sink: <input type="text"/> Floor Sink: <input type="text"/>							Other Fixtures: <input type="checkbox"/> Shower <input type="checkbox"/> Eyewash Station <input type="checkbox"/> Tub <input type="checkbox"/> Eyewash/Shower Station <input type="checkbox"/> Ice Maker <input type="checkbox"/> Emergency Shower <input type="checkbox"/> Water Closet <input type="checkbox"/> Flush Rim Sink <input type="checkbox"/> Instantaneous Hot Water <input checked="" type="checkbox"/> Floor Drain <input checked="" type="checkbox"/> Water Bottle Refill Station Other <input type="text"/>				<b>MED / NON-MED GASES</b> (Quantity) Oxygen: <input type="text"/> Medical Air: <input type="text"/> Medical Vacuum: <input type="text"/> Nitrous Oxide: <input type="text"/> CO2: <input type="text"/> AGSS: <input type="text"/> Nitrogen: <input type="text"/> Laboratory Air: <input type="text"/> Laboratory Vacuum: <input type="text"/> Utility Compressed Air: <input type="text"/>					
Plumbing Remarks: <input type="text"/>											Gas Remarks: <input type="text"/>					

**Appendix 1B Minimum Room Requirements**

Room Name:

Program Number(s):

1. F2.07	7.	13.	19.	25.	31.	37.	43.
2. F6.01	8.	14.	20.	26.	32.	38.	44.
3. L1.09	9.	15.	21.	27.	33.	39.	45.
4.	10.	16.	22.	28.	34.	40.	46.
5.	11.	17.	23.	29.	35.	41.	47.
6.	12.	18.	24.	30.	36.	42.	48.

**ARCHITECTURAL REQUIREMENTS**

<b>WALL AND CEILING</b> Wall Material: <input type="text" value="ARGB 1.2m AFF, GB above"/> Finish: <input type="text" value="PT"/> Ceiling Material: <input type="text" value="ACT"/> Finish: <input type="text" value="PF"/>		<b>WALL PROTECTION</b> Type: <input type="text" value="FRL"/> <input type="checkbox"/> Corner Guards <input type="checkbox"/> Hand Rails <input type="checkbox"/> Bed Bumper / Locator Height: <input type="text" value="1350 mm"/> <input type="checkbox"/> Crash Rails <input checked="" type="checkbox"/> Chair Rail			<b>GLAZING</b> <input type="checkbox"/> Interior Glazing		<b>FLOORING TYPES</b> Material: <input type="text" value="VSF"/> Base: <input type="text" value="FCB"/>		<b>ROOM ACCESSORIES</b> <input type="checkbox"/> Coat Hooks <input type="checkbox"/> Ceiling Lift <input type="checkbox"/> Magnetic Whiteboard <input type="checkbox"/> Mirror <input type="checkbox"/> Infant Change Table <input type="checkbox"/> Privacy Curtain		
--	--	---	--	--	---	--	--	--	--	--	--

- LEGEND:**
- WALL AND CEILING LEGEND:**
- AC Architectural Ceiling
  - ACT Acoustic Ceiling Tile
  - ACT-C Cleanroom
  - ARGB Abuse-Resistant Gypsum Board
  - GB Gypsum Board
  - IRGB Impact-Resistant Gypsum Board
  - KLCT Kitchen Lay-in Ceiling Tile
  - MMRGB Moisture and Mould-Resistant Gypsum Board
  - SACT Security Acoustic Ceiling Tile
- WALL FINISHES LEGEND:**
- EWC Epoxy Wall Coating
  - HPC High Performance Coating
  - PT Paint
- CEILING FINISHES LEGEND:**
- ECC Epoxy Ceiling Coating
  - HPC High Performance Coating
  - PF Prefinished
  - PT Paint
- WALL PROTECTION LEGEND:**
- ESRP Extruded Semi-Rigid PVCu Panel
  - FRL Fibre Reinforced Laminate
  - FRP Fibreglass Reinforced Plastic
  - PVV Protective Vinyl Wallcovering
  - RHIS Rigid High Impact Sheet
  - WSSP Wetwall Solid Surface Panel
  - WVV Wetroom Vinyl Wallcovering
- FLOOR FINISHES LEGEND:**
- CFS Concrete Floor Sealer
  - EFC Epoxy Floor Coating
  - PFC Polyurethane Floor Coating
  - RAF Rubber Athletic Flooring
  - RSF Rubber Sheet Flooring
  - SCF Seamless Cushioned Flooring
  - SDRF Static-Dissipative Rubber Sheet Flooring
  - SDVF Static-Dissipative Vinyl Sheet Flooring
  - VSF Vinyl Sheet Flooring
  - WSVF Wetroom Safety Vinyl Sheet Flooring
- FLOOR BASE LEGEND:**
- FCB Flash Cove Base
  - RB Rubber Base
  - SCF Seamless Cushioned Flooring

**DOORS**

Types:

Type	Qty	Size (mm)	Material	Finish	Side Lt.	Blinds	Protect.	Privacy Film	Function	Card Reader	Mag Lock	Auto Opener	Hold Open	Hinges	Accessory 1	Accessory 2	Accessory 3	Closer

Door Remarks:  Security Grille  Anti-barricade strategy

**MILLWORK AND SPECIALTY CASEWORK**

**UPPER UNITS** (U1-U8) **SHELF** (S1)

**LOWER UNITS** (L1-L12) **RECEPTION/TRANSACTION COUNTER / CARE TEAM STATION DESK** (TC1, TC2) **UTILITY SINK AND COUNTER UNIT** (UC1)

**FULL-HEIGHT CABINETS** (C1-C5)

Storage Requirements:

**FINISHES**

Full-height Cabinet:   
 Upper Millwork:   
 Countertop:   
 Lower Millwork:   
 Shelf:

Remarks:

**Legend:**

Category	Min. Length (mm)	Motorized Adjustable Height	Standing Height	Specialty Casework
Category 0 - None				
Category 1 - Low (1% - 4%)				
Category 2 - Med (5% - 9%)				
Category 3 - High (10% or Greater)				

**MECHANICAL REQUIREMENTS**

<b>PLUMBING</b> (Quantity) Hygiene Sink: <input type="text"/> Lavatory: <input type="text"/> Kitchen Sink: <input type="text"/> Seamless Kitchen Sink: <input type="text"/> Utility / Process Sink: <input type="text"/> Scrub Sink: <input type="text"/> Floor Sink: <input type="text"/>							Other Fixtures: <input type="checkbox"/> Shower <input type="checkbox"/> Eyewash Station <input type="checkbox"/> Tub <input type="checkbox"/> Eyewash/Shower Station <input type="checkbox"/> Ice Maker <input type="checkbox"/> Emergency Shower <input type="checkbox"/> Water Closet <input type="checkbox"/> Flush Rim Sink <input type="checkbox"/> Instantaneous Hot Water <input checked="" type="checkbox"/> Floor Drain <input type="checkbox"/> Water Bottle Refill Station				<b>MED / NON-MED GASES</b> (Quantity) Oxygen: <input type="text"/> Medical Air: <input type="text"/> Medical Vacuum: <input type="text"/> Nitrous Oxide: <input type="text"/> CO2: <input type="text"/> AGSS: <input type="text"/> Nitrogen: <input type="text"/> Laboratory Air: <input type="text"/> Laboratory Vacuum: <input type="text"/> Utility Compressed Air: <input type="text"/>					
Plumbing Remarks: <input type="text"/>							Gas Remarks: <input type="text"/>									



# Appendix 1B Minimum Room Requirements

Room Name:

Program Number(s):

1. A3.11	7. E8.04	13. G1.12	19. M2.17	25.	31.	37.	43.
2. C3.17	8. F2.05	14. I2.20	20. N1.07	26.	32.	38.	44.
3. C4.04	9. F3.06	15. K3.05	21.	27.	33.	39.	45.
4. C5.08	10. F4.04	16. K4.06	22.	28.	34.	40.	46.
5. D3.14	11. F5.04	17. L1.11	23.	29.	35.	41.	47.
6. D6.11	12. F6.05	18. L2.16	24.	30.	36.	42.	48.

## ARCHITECTURAL REQUIREMENTS

<b>WALL AND CEILING</b> Wall Material: <input type="text" value="MMRGB"/> Finish: <input type="text" value="EWC"/> Ceiling Material: <input type="text" value="MMRGB"/> Finish: <input type="text" value="ECC"/>	<b>WALL PROTECTION</b> Type: <input type="text" value="FRP"/> <input checked="" type="checkbox"/> Corner Guards <input type="checkbox"/> Hand Rails <input type="checkbox"/> Bed Bumper / Locator Height: <input type="text" value="1350 mm"/> <input type="checkbox"/> Crash Rails <input type="checkbox"/> Chair Rail	<b>GLAZING</b> <input type="checkbox"/> Interior Glazing	<b>FLOORING TYPES</b> Material: <input type="text" value="WSVF"/> Base: <input type="text" value="FCB"/>	<b>ROOM ACCESSORIES</b> <input checked="" type="checkbox"/> Coat Hooks <input type="checkbox"/> Ceiling Lift <input type="checkbox"/> Magnetic Whiteboard <input checked="" type="checkbox"/> Mirror <input type="checkbox"/> Infant Change Table <input type="checkbox"/> Privacy Curtain
--	---	---	---	--

- LEGEND:**
- WALL AND CEILING LEGEND:**
- AC Architectural Ceiling
  - ACT Acoustic Ceiling Tile
  - ACT-C Cleanroom
  - ARGB Abuse-Resistant Gypsum Board
  - GB Gypsum Board
  - IRGB Impact-Resistant Gypsum Board
  - KLCT Kitchen Lay-in Ceiling Tile
  - MMRGB Moisture and Mould-Resistant Gypsum Board
  - SACT Security Acoustic Ceiling Tile
- WALL FINISHES LEGEND:**
- EWC Epoxy Wall Coating
  - HPC High Performance Coating
  - PT Paint
- CEILING FINISHES LEGEND:**
- ECC Epoxy Ceiling Coating
  - HPC High Performance Coating
  - PF Prefinished
  - PT Paint
- WALL PROTECTION LEGEND:**
- ESRP Extruded Semi-Rigid PVCu Panel
  - FRL Fibre Reinforced Laminate
  - FRP Fibreglass Reinforced Plastic
  - PVV Protective Vinyl Wallcovering
  - RHIS Rigid High Impact Sheet
  - WSSP Wetwall Solid Surface Panel
  - WVV Wetroom Vinyl Wallcovering
- FLOOR FINISHES LEGEND:**
- CFS Concrete Floor Sealer
  - EFC Epoxy Floor Coating
  - PFC Polyurethane Floor Coating
  - RAF Rubber Athletic Flooring
  - RSF Rubber Sheet Flooring
  - SCF Seamless Cushioned Flooring
  - SDRF Static-Dissipative Rubber Sheet Flooring
  - SDVF Static-Dissipative Vinyl Sheet Flooring
  - VSF Vinyl Sheet Flooring
  - WSVF Wetroom Safety Vinyl Sheet Flooring
- FLOOR BASE LEGEND:**
- FCB Flash Cove Base
  - RB Rubber Base
  - SCF Seamless Cushioned Flooring

**DOORS**

Types:

Integral Door & Frame Privacy Card Mag Auto Hold  
Blinds: Protect.: Film: Function: Reader: Lock: Opener: Open:

Type: A	Qty: 1	Size (mm): 1065 x 2135	Material: Solid Core	Finish: FRL	Side Lt:	Blinds:	Protect.: 1 Low	Film:	Function: Privacy	Card Reader:	Mag Lock:	Auto Opener:	Hold Open:	Hinges: Cont. Double-Acting	Accessory 1: Safety Stop	Accessory 2:	Accessory 3:	Closer: Surface
---------	--------	------------------------	----------------------	-------------	----------	---------	-----------------	-------	-------------------	--------------	-----------	--------------	------------	-----------------------------	--------------------------	--------------	--------------	-----------------

Door Remarks: Provide Hollow Metal door for M2.17 located within PET CT Functional Imaging.

Security Grille  
 Anti-barricade strategy

**MILLWORK AND SPECIALTY CASEWORK**

Storage Requirements:

**UPPER UNITS** U1 U2 U3 U4 U5 U6 U7 U8

**LOWER UNITS** L1 L2 L3 L4 L5 L6 L7 L8 L9 L10 L11 L12

**RECEPTION/TRANSACTION COUNTER / CARE TEAM STATION DESK** TC1 TC2

**UTILITY SINK AND COUNTER UNIT** UC1

**SHELF** S1

**FULL-HEIGHT CABINETS** C1 C2 C3 C4 C5

**Legend:**  
 Category 0 - None  
 Category 1 - Low (1% - 4%)  
 Category 2 - Med (5% - 9%)  
 Category 3 - High (10% or Greater)

Category	Min. Length (mm)	Motorized Adjustable Height	Standing Height	Specialty Casework
2	600	<input type="checkbox"/>	<input type="checkbox"/>	<input type="checkbox"/>

**FINISHES**

Full-height Cabinet:   
 Upper Millwork:   
 Countertop:   
 Lower Millwork:   
 Shelf:

Remarks:

## MECHANICAL REQUIREMENTS

**PLUMBING** (Quantity)

Hand Hygiene Sink:	Lavatory:	Kitchen Sink:	Seamless Kitchen Sink:	Utility / Process Sink:	Scrub Sink:	Floor Sink:
	1					

Plumbing Remarks:

**Other Fixtures:**

- Shower
- Tub
- Ice Maker
- Water Closet
- Instantaneous Hot Water
- Eyewash Station
- Eyewash/Shower Station
- Emergency Shower
- Flush Rim Sink
- Floor Drain
- Water Bottle Refill Station

Other:

**MED / NON-MED GASES** (Quantity)

Oxygen:	Medical Air:	Medical Vacuum:	Nitrous Oxide:	CO2:	AGSS:	Nitrogen:	Laboratory Air:	Laboratory Vacuum:	Utility Compressed Air:

Gas Remarks:

**Appendix 1B Minimum Room Requirements**

Room Name:

Program Number(s):

1. A2.07	7.	13.	19.	25.	31.	37.	43.
2. C3.19	8.	14.	20.	26.	32.	38.	44.
3. C4.15	9.	15.	21.	27.	33.	39.	45.
4. I2.21	10.	16.	22.	28.	34.	40.	46.
5.	11.	17.	23.	29.	35.	41.	47.
6.	12.	18.	24.	30.	36.	42.	48.

**ARCHITECTURAL REQUIREMENTS**

<b>WALL AND CEILING</b> Wall Material: <input type="text" value="MMRGB"/> Finish: <input type="text" value="EWC"/> Ceiling Material: <input type="text" value="MMRGB"/> Finish: <input type="text" value="ECC"/>		<b>WALL PROTECTION</b> Type: <input type="text" value="FRP"/> <input checked="" type="checkbox"/> Corner Guards <input type="checkbox"/> Hand Rails <input type="checkbox"/> Bed Bumper / Locator Height: <input type="text" value="1350 mm"/> <input type="checkbox"/> Crash Rails <input type="checkbox"/> Chair Rail		<b>GLAZING</b> <input type="checkbox"/> Interior Glazing		<b>FLOORING TYPES</b> Material: <input type="text" value="WSVF"/> Base: <input type="text" value="FCB"/>		<b>ROOM ACCESSORIES</b> <input checked="" type="checkbox"/> Coat Hooks <input type="checkbox"/> Ceiling Lift <input type="checkbox"/> Magnetic Whiteboard <input checked="" type="checkbox"/> Mirror <input type="checkbox"/> Infant Change Table <input type="checkbox"/> Privacy Curtain	
--	--	---	--	---	--	---	--	--	--

- LEGEND:**
- WALL AND CEILING LEGEND:**
- AC Architectural Ceiling
  - ACT Acoustic Ceiling Tile
  - ACT-C Cleanroom
  - ARGB Abuse-Resistant Gypsum Board
  - GB Gypsum Board
  - IRGB Impact-Resistant Gypsum Board
  - KLCT Kitchen Lay-in Ceiling Tile
  - MMRGB Moisture and Mould-Resistant Gypsum Board
  - SACT Security Acoustic Ceiling Tile
- WALL FINISHES LEGEND:**
- EWC Epoxy Wall Coating
  - HPC High Performance Coating
  - PT Paint
- CEILING FINISHES LEGEND:**
- ECC Epoxy Ceiling Coating
  - HPC High Performance Coating
  - PF Prefinished
  - PT Paint
- WALL PROTECTION LEGEND:**
- ESRP Extruded Semi-Rigid PVCu Panel
  - FRL Fibre Reinforced Laminate
  - FRP Fibreglass Reinforced Plastic
  - PVV Protective Vinyl Wallcovering
  - RHIS Rigid High Impact Sheet
  - WSSP Wetwall Solid Surface Panel
  - WVV Wetroom Vinyl Wallcovering
- FLOOR FINISHES LEGEND:**
- CFS Concrete Floor Sealer
  - EFC Epoxy Floor Coating
  - PFC Polyurethane Floor Coating
  - RAF Rubber Athletic Flooring
  - RSF Rubber Sheet Flooring
  - SCF Seamless Cushioned Flooring
  - SDRF Static-Dissipative Rubber Sheet Flooring
  - SDVF Static-Dissipative Vinyl Sheet Flooring
  - VSF Vinyl Sheet Flooring
  - WSVF Wetroom Safety Vinyl Sheet Flooring
- FLOOR BASE LEGEND:**
- FCB Flash Cove Base
  - RB Rubber Base
  - SCF Seamless Cushioned Flooring

**DOORS**

Types:

Note: for Type F doors, the door panels will be approximately 465/1065 unless otherwise required by the Authority

Door Remarks:  Security Grille  Anti-barricade strategy

Type	Qty	Size (mm)	Material	Finish	Side Lt.	Blinds	Protect.	Privacy	Function	Card Reader	Mag Lock	Auto Opener	Hold Open	Hinges	Accessory 1	Accessory 2	Accessory 3	Closer
F	1	1530 x 2135	Solid Core	FRL	<input type="checkbox"/>	<input type="checkbox"/>	1 Low	<input type="checkbox"/>	Privacy	<input type="checkbox"/>	<input type="checkbox"/>	<input type="checkbox"/>	<input type="checkbox"/>	Cont. Double-Acting	Astragal	Flush Bolt	Safety Stop	Surface

**MILLWORK AND SPECIALTY CASEWORK**

Storage Requirements:

**UPPER UNITS** (U1-U8) **SHELF** (S1)

**FULL-HEIGHT CABINETS** (C1-C5) **LOWER UNITS** (L1-L12) **RECEPTION/TRANSACTION COUNTER / CARE TEAM STATION DESK** (TC1-TC2) **UTILITY SINK AND COUNTER UNIT** (UC1)

**Legend:**

Category	Min. Length (mm)	Motorized Adjustable Height	Standing Height	Specialty Casework
Category 0 - None				
Category 1 - Low (1% - 4%)				
Category 2 - Med (5% - 9%)				
Category 3 - High (10% or Greater)				

**FINISHES**

Full-height Cabinet:

Upper Millwork:

Countertop:

Lower Millwork:

Shelf:

Remarks:

**MECHANICAL REQUIREMENTS**

<b>PLUMBING</b> (Quantity) Hygiene Sink: <input type="text"/> Lavatory: <input type="text"/> Kitchen Sink: <input type="text"/> Kitchen Sink: <input type="text"/> Utility / Process Sink: <input type="text"/> Scrub Sink: <input type="text"/> Floor Sink: <input type="text"/>		Other Fixtures: <input type="checkbox"/> Shower <input type="checkbox"/> Tub <input type="checkbox"/> Ice Maker <input checked="" type="checkbox"/> Water Closet <input type="checkbox"/> Instantaneous Hot Water		<input type="checkbox"/> Eyewash Station <input type="checkbox"/> Eyewash/Shower Station <input type="checkbox"/> Emergency Shower <input type="checkbox"/> Flush Rim Sink <input type="checkbox"/> Floor Drain <input type="checkbox"/> Water Bottle Refill Station		<b>MED / NON-MED GASES</b> (Quantity) Oxygen: <input type="text"/> Medical Air: <input type="text"/> Medical Vacuum: <input type="text"/> Nitrous Oxide: <input type="text"/> CO2: <input type="text"/> AGSS: <input type="text"/> Nitrogen: <input type="text"/> Laboratory Air: <input type="text"/> Laboratory Vacuum: <input type="text"/> Utility Compressed Air: <input type="text"/>	
Plumbing Remarks: <input type="text" value="Provide floor mounted water closet."/>		Gas Remarks: <input type="text"/>					

**Appendix 1B Minimum Room Requirements**

Room Name:

Program Number(s):

1. A1.04	7. D1.04	13. T4.06	19.	25.	31.	37.	43.
2. B1.21	8. F1.05	14. U1.03	20.	26.	32.	38.	44.
3. B2.13	9. I1.04	15. V1.04	21.	27.	33.	39.	45.
4. B3.12	10. M2.04	16.	22.	28.	34.	40.	46.
5. B4.02	11. T1.03	17.	23.	29.	35.	41.	47.
6. C1.05	12. T2.02	18.	24.	30.	36.	42.	48.

**ARCHITECTURAL REQUIREMENTS**

<b>WALL AND CEILING</b> Wall Material: <input type="text" value="MMRGB"/> Finish: <input type="text" value="EWC"/> Ceiling Material: <input type="text" value="MMRGB"/> Finish: <input type="text" value="ECC"/>		<b>WALL PROTECTION</b> Type: <input type="text" value="FRP"/> <input checked="" type="checkbox"/> Corner Guards <input type="checkbox"/> Hand Rails <input type="checkbox"/> Bed Bumper / Locator Height: <input type="text" value="1350 mm"/> <input type="checkbox"/> Crash Rails <input type="checkbox"/> Chair Rail		<b>GLAZING</b> <input type="checkbox"/> Interior Glazing		<b>FLOORING TYPES</b> Material: <input type="text" value="WSVF"/> Base: <input type="text" value="FCB"/>		<b>ROOM ACCESSORIES</b> <input checked="" type="checkbox"/> Coat Hooks <input type="checkbox"/> Ceiling Lift <input type="checkbox"/> Magnetic Whiteboard <input checked="" type="checkbox"/> Mirror <input checked="" type="checkbox"/> Infant Change Table <input type="checkbox"/> Privacy Curtain	
--	--	---	--	---	--	---	--	---	--

- LEGEND:**
- WALL AND CEILING LEGEND:**
- AC Architectural Ceiling
  - ACT Acoustic Ceiling Tile
  - ACT-C Cleanroom
  - ARGB Abuse-Resistant Gypsum Board
  - GB Gypsum Board
  - IRGB Impact-Resistant Gypsum Board
  - KLCT Kitchen Lay-in Ceiling Tile
  - MMRGB Moisture and Mould-Resistant Gypsum Board
  - SACT Security Acoustic Ceiling Tile
- WALL FINISHES LEGEND:**
- EWC Epoxy Wall Coating
  - HPC High Performance Coating
  - PT Paint
- CEILING FINISHES LEGEND:**
- ECC Epoxy Ceiling Coating
  - HPC High Performance Coating
  - PF Prefinished
  - PT Paint
- WALL PROTECTION LEGEND:**
- ESRP Extruded Semi-Rigid PVCu Panel
  - FRL Fibre Reinforced Laminate
  - FRP Fibreglass Reinforced Plastic
  - PVV Protective Vinyl Wallcovering
  - RHIS Rigid High Impact Sheet
  - WSSP Wetwall Solid Surface Panel
  - WVV Wetroom Vinyl Wallcovering
- FLOOR FINISHES LEGEND:**
- CFS Concrete Floor Sealer
  - EFC Epoxy Floor Coating
  - PFC Polyurethane Floor Coating
  - RAF Rubber Athletic Flooring
  - RSF Rubber Sheet Flooring
  - SCF Seamless Cushioned Flooring
  - SDRF Static-Dissipative Rubber Sheet Flooring
  - SDVF Static-Dissipative Vinyl Sheet Flooring
  - VSF Vinyl Sheet Flooring
  - WSVF Wetroom Safety Vinyl Sheet Flooring
- FLOOR BASE LEGEND:**
- FCB Flash Cove Base
  - RB Rubber Base
  - SCF Seamless Cushioned Flooring

**DOORS**

Types:

Type	Qty	Size (mm)	Material	Finish	Side Lt.	Blinds	Protect.	Privacy Film	Function	Card Reader	Mag Lock	Auto Opener	Hold Open	Hinges	Accessory 1	Accessory 2	Accessory 3	Closer
A	1	1065 x 2135	Solid Core	FRL	<input type="checkbox"/>	<input type="checkbox"/>	2 High	<input type="checkbox"/>	Privacy	<input type="checkbox"/>	<input type="checkbox"/>	<input checked="" type="checkbox"/>	<input type="checkbox"/>	Cont. Double-Acting	Safety Stop	Elec. Strike		Surface

**Door Remarks:**

Automatic operator with double acting arm capable of being pulled open from the corridor side.  Security Grille  Anti-barricade strategy

**MILLWORK AND SPECIALTY CASEWORK**

Storage Requirements:

**UPPER UNITS:** U1, U2, U3, U4, U5, U6, U7, U8

**LOWER UNITS:** L1, L2, L3, L4, L5, L6, L7, L8, L9, L10, L11, L12

**RECEPTION/TRANSACTION COUNTER / CARE TEAM STATION DESK:** TC1, TC2

**UTILITY SINK AND COUNTER UNIT:** UC1

**SHELF:** S1

**FULL-HEIGHT CABINETS:** C1, C2, C3, C4, C5

**Legend:**

Category	Min. Length (mm)	Motorized Adjustable Height	Standing Height	Specialty Casework
Category 0 - None				
Category 1 - Low (1% - 4%)				
Category 2 - Med (5% - 9%)				
Category 3 - High (10% or Greater)	2	600	<input type="checkbox"/>	<input type="checkbox"/>

**FINISHES**

Full-height Cabinet:

Upper Millwork:

Countertop:

Lower Millwork:

Shelf:

**Remarks:**

**MECHANICAL REQUIREMENTS**

<b>PLUMBING</b> (Quantity) Hand Hygiene Sink: <input type="text"/> Lavatory: <input type="text" value="1"/> Kitchen Sink: <input type="text"/> Seamless Kitchen Sink: <input type="text"/> Utility / Process Sink: <input type="text"/> Scrub Sink: <input type="text"/> Floor Sink: <input type="text"/>		Other Fixtures: <input type="checkbox"/> Shower <input type="checkbox"/> Tub <input type="checkbox"/> Ice Maker <input checked="" type="checkbox"/> Water Closet <input type="checkbox"/> Instantaneous Hot Water		<input type="checkbox"/> Eyewash Station <input type="checkbox"/> Eyewash/Shower Station <input type="checkbox"/> Emergency Shower <input type="checkbox"/> Flush Rim Sink <input type="checkbox"/> Floor Drain <input type="checkbox"/> Water Bottle Refill Station		<b>MED / NON-MED GASES</b> (Quantity) Oxygen: <input type="text"/> Medical Air: <input type="text"/> Medical Vacuum: <input type="text"/> Nitrous Oxide: <input type="text"/> CO2: <input type="text"/> AGSS: <input type="text"/> Nitrogen: <input type="text"/> Laboratory Air: <input type="text"/> Laboratory Vacuum: <input type="text"/> Utility Compressed Air: <input type="text"/>	
Plumbing Remarks: <input type="text"/>		Gas Remarks: <input type="text"/>					



**Appendix 1B Minimum Room Requirements**

Room Name:

Program Number(s):

1. A4.07	7. Not Used	13. F8.09	19. K1.13	25. Not Used	31. T2.07	37. Y2.02	43.
2. B1.20	8. Not Used	14. G1.13	20. Not Used	26. M2.34	32. Not Used	38. Y4.04	44.
3. B2.22	9. Not Used	15. H1.10	21. Not Used	27. N3.10	33. U5.10	39. Y5.03	45.
4. B3.22	10. D7.02	16. I3.03	22. L3.07	28. P4.03	34. U7.02	40.	46.
5. Not Used	11. E7.05	17. J5.03	23. M1.03	29. R4.07	35. W1.07	41.	47.
6. C4.25	12. Not Used	18. Not Used	24. Not Used	30. S2.04	36. X4.04	42.	48.

**ARCHITECTURAL REQUIREMENTS**

<b>WALL AND CEILING</b> Wall Material: <input type="text" value="MMRGB"/> Finish: <input type="text" value="EWC"/> Ceiling Material: <input type="text" value="MMRGB"/> Finish: <input type="text" value="ECC"/>	<b>WALL PROTECTION</b> Type: <input type="text" value="FRP"/> <input checked="" type="checkbox"/> Corner Guards <input type="checkbox"/> Hand Rails <input type="checkbox"/> Bed Bumper / Locator Height: <input type="text" value="1350 mm"/> <input type="checkbox"/> Crash Rails <input type="checkbox"/> Chair Rail	<b>GLAZING</b> <input type="checkbox"/> Interior Glazing	<b>FLOORING TYPES</b> Material: <input type="text" value="WSVF"/> Base: <input type="text" value="FCB"/>	<b>ROOM ACCESSORIES</b> <input checked="" type="checkbox"/> Coat Hooks <input type="checkbox"/> Ceiling Lift <input type="checkbox"/> Magnetic Whiteboard <input checked="" type="checkbox"/> Mirror <input type="checkbox"/> Infant Change Table <input type="checkbox"/> Privacy Curtain
--	---	---	---	--

- LEGEND:**
- WALL AND CEILING LEGEND:**
- AC Architectural Ceiling
  - ACT Acoustic Ceiling Tile
  - ACT-C Cleanroom
  - ARGB Abuse-Resistant Gypsum Board
  - GB Gypsum Board
  - IRGB Impact-Resistant Gypsum Board
  - KLCT Kitchen Lay-in Ceiling Tile
  - MMRGB Moisture and Mould-Resistant Gypsum Board
  - SACT Security Acoustic Ceiling Tile
- WALL FINISHES LEGEND:**
- EWC Epoxy Wall Coating
  - HPC High Performance Coating
  - PT Paint
- CEILING FINISHES LEGEND:**
- ECC Epoxy Ceiling Coating
  - HPC High Performance Coating
  - PF Prefinished
  - PT Paint
- WALL PROTECTION LEGEND:**
- ESRP Extruded Semi-Rigid PVCu Panel
  - FRL Fibre Reinforced Laminate
  - FRP Fibreglass Reinforced Plastic
  - PVV Protective Vinyl Wallcovering
  - RHIS Rigid High Impact Sheet
  - WSSP Wetwall Solid Surface Panel
  - WVV Wetroom Vinyl Wallcovering
- FLOOR FINISHES LEGEND:**
- CFS Concrete Floor Sealer
  - EFC Epoxy Floor Coating
  - PFC Polyurethane Floor Coating
  - RAF Rubber Athletic Flooring
  - RSF Rubber Sheet Flooring
  - SCF Seamless Cushioned Flooring
  - SDRF Static-Dissipative Rubber Sheet Flooring
  - SDVF Static-Dissipative Vinyl Sheet Flooring
  - VSF Vinyl Sheet Flooring
  - WSVF Wetroom Safety Vinyl Sheet Flooring
- FLOOR BASE LEGEND:**
- FCB Flash Cove Base
  - RB Rubber Base
  - SCF Seamless Cushioned Flooring

**DOORS**

Types:

Type	Qty	Size (mm)	Material	Finish	Side Lt.	Blinds	Protect.	Privacy Film	Function	Card Reader	Mag Lock	Auto Opener	Hold Open	Hinges	Accessory 1	Accessory 2	Accessory 3	Closer
A	1	1065 x 2135	Solid Core	FRL	<input type="checkbox"/>	<input type="checkbox"/>	1 Low	<input type="checkbox"/>	Privacy	<input type="checkbox"/>	<input type="checkbox"/>	<input type="checkbox"/>	<input type="checkbox"/>	Cont. Double-Acting	Safety Stop			Surface

Door Remarks:  Security Grille  Anti-barricade strategy

**MILLWORK AND SPECIALTY CASEWORK**

Storage Requirements:

**UPPER UNITS** (U1-U8) **LOWER UNITS** (L1-L12) **RECEPTION/TRANSACTION COUNTER / CARE TEAM STATION DESK** (TC1-TC2) **UTILITY SINK AND COUNTER UNIT** (UC1)

**FULL-HEIGHT CABINETS** (C1-C5)

**SHelf** (S1)

**Legend:**

Category	Min. Length (mm)	Motorized Adjustable Height	Standing Height	Specialty Casework
2	600	<input type="checkbox"/>	<input type="checkbox"/>	<input type="checkbox"/>

**FINISHES**

Full-height Cabinet:   
 Upper Millwork:   
 Countertop:   
 Lower Millwork:   
 Shelf:

Remarks:

**MECHANICAL REQUIREMENTS**

**PLUMBING**

Hand Hygiene Sink:	Lavatory:	Kitchen Sink:	Seamless Kitchen Sink:	Utility / Process Sink:	Scrub Sink:	Floor Sink:
	1					

Plumbing Remarks:

**Other Fixtures:**

- Shower
- Tub
- Ice Maker
- Water Closet
- Instantaneous Hot Water
- Eyewash Station
- Eyewash/Shower Station
- Emergency Shower
- Flush Rim Sink
- Floor Drain
- Water Bottle Refill Station

Other:

**MED / NON-MED GASES**

Oxygen:	Medical Air:	Medical Vacuum:	Nitrous Oxide:	CO2:	AGSS:	Nitrogen:	Laboratory Air:	Laboratory Vacuum:	Utility Compressed Air:

Gas Remarks:

**Appendix 1B Minimum Room Requirements**

Room Name:

Program Number(s):

1. A4.12	7. E7.08	13. J5.08	19. M1.20	25. U3.03	31.	37.	43.
2. B1.23	8. F4.17	14. K1.06	20. M2.13	26. U5.11	32.	38.	44.
3. C3.33	9. F8.11	15. L1.12	21. N3.11	27. U7.04	33.	39.	45.
4. D6.20	10. G1.28	16. L2.17	22. P4.11	28. Y4.06	34.	40.	46.
5. D2.26	11. H1.11	17. L3.09	23. R4.09	29. W3.07	35.	41.	47.
6. D3.12	12. I3.04	18. M1.41	24. T2.09	30. W4.25	36.	42.	48.

**ARCHITECTURAL REQUIREMENTS**

<b>WALL AND CEILING</b> Wall Material: <input type="text" value="MMRGB"/> Finish: <input type="text" value="EWC"/> Ceiling Material: <input type="text" value="MMRGB"/> Finish: <input type="text" value="ECC"/>		<b>WALL PROTECTION</b> Type: <input type="text" value="FRP"/> <input checked="" type="checkbox"/> Corner Guards <input type="checkbox"/> Hand Rails <input type="checkbox"/> Bed Bumper / Locator Height: <input type="text" value="1350 mm"/> <input type="checkbox"/> Crash Rails <input type="checkbox"/> Chair Rail		<b>GLAZING</b> <input type="checkbox"/> Interior Glazing		<b>FLOORING TYPES</b> Material: <input type="text" value="WSVF"/> Base: <input type="text" value="FCB"/>		<b>ROOM ACCESSORIES</b> <input checked="" type="checkbox"/> Coat Hooks <input type="checkbox"/> Ceiling Lift <input type="checkbox"/> Magnetic Whiteboard <input checked="" type="checkbox"/> Mirror <input type="checkbox"/> Infant Change Table <input type="checkbox"/> Privacy Curtain	
--	--	---	--	---	--	---	--	--	--

- LEGEND:**
- WALL AND CEILING LEGEND:**
- AC Architectural Ceiling
  - ACT Acoustic Ceiling Tile
  - ACT-C Cleanroom
  - ARGB Abuse-Resistant Gypsum Board
  - GB Gypsum Board
  - IRGB Impact-Resistant Gypsum Board
  - KLCT Kitchen Lay-in Ceiling Tile
  - MMRGB Moisture and Mould-Resistant Gypsum Board
  - SACT Security Acoustic Ceiling Tile
- WALL FINISHES LEGEND:**
- EWC Epoxy Wall Coating
  - HPC High Performance Coating
  - PT Paint
- CEILING FINISHES LEGEND:**
- ECC Epoxy Ceiling Coating
  - HPC High Performance Coating
  - PF Prefinished
  - PT Paint
- WALL PROTECTION LEGEND:**
- ESRP Extruded Semi-Rigid PVCu Panel
  - FRL Fibre Reinforced Laminate
  - FRP Fibreglass Reinforced Plastic
  - PVV Protective Vinyl Wallcovering
  - RHIS Rigid High Impact Sheet
  - WSSP Wetwall Solid Surface Panel
  - WVV Wetroom Vinyl Wallcovering
- FLOOR FINISHES LEGEND:**
- CFS Concrete Floor Sealer
  - EFC Epoxy Floor Coating
  - PFC Polyurethane Floor Coating
  - RAF Rubber Athletic Flooring
  - RSF Rubber Sheet Flooring
  - SCF Seamless Cushioned Flooring
  - SDRF Static-Dissipative Rubber Sheet Flooring
  - SDVF Static-Dissipative Vinyl Sheet Flooring
  - VSF Vinyl Sheet Flooring
  - WSVF Wetroom Safety Vinyl Sheet Flooring
- FLOOR BASE LEGEND:**
- FCB Flash Cove Base
  - RB Rubber Base
  - SCF Seamless Cushioned Flooring

**DOORS**

Types:

Type	Qty	Size (mm)	Material	Finish	Side Lt.	Blinds	Protect.	Privacy Film	Function	Card Reader	Mag Lock	Auto Opener	Hold Open	Hinges	Accessory 1	Accessory 2	Accessory 3	Closer
A	1	915 x 2135	Solid Core	FRL	<input type="checkbox"/>	<input type="checkbox"/>	1 Low	<input type="checkbox"/>	Privacy	<input type="checkbox"/>	<input type="checkbox"/>	<input type="checkbox"/>	<input type="checkbox"/>	Cont. Double-Acting	Safety Stop			Surface

Door Remarks:  Security Grille  Anti-barricade strategy

**MILLWORK AND SPECIALTY CASEWORK**

**UPPER UNITS** (U1-U8) **LOWER UNITS** (L1-L12) **RECEPTION/TRANSACTION COUNTER / CARE TEAM STATION DESK** (TC1-TC2) **UTILITY SINK AND COUNTER UNIT** (UC1)

Storage Requirements:  SHELF  S1

Category	Min. Length (mm)	Motorized Adjustable Height	Standing Height	Specialty Casework
3	600	<input type="checkbox"/>	<input type="checkbox"/>	<input type="checkbox"/>

**FINISHES**

Full-height Cabinet:   
 Upper Millwork:   
 Countertop:   
 Lower Millwork:   
 Shelf:

Remarks:

**MECHANICAL REQUIREMENTS**

<b>PLUMBING</b> (Quantity) Hygiene Sink: <input type="text"/> Lavatory: <input type="text" value="1"/> Kitchen Sink: <input type="text"/> Kitchen Sink: <input type="text"/> Utility / Process Sink: <input type="text"/> Scrub Sink: <input type="text"/> Floor Sink: <input type="text"/>		Other Fixtures: <input type="checkbox"/> Shower <input type="checkbox"/> Tub <input type="checkbox"/> Ice Maker <input checked="" type="checkbox"/> Water Closet <input type="checkbox"/> Instantaneous Hot Water		<input type="checkbox"/> Eyewash Station <input type="checkbox"/> Eyewash/Shower Station <input type="checkbox"/> Emergency Shower <input type="checkbox"/> Flush Rim Sink <input type="checkbox"/> Floor Drain <input type="checkbox"/> Water Bottle Refill Station		<b>MED / NON-MED GASES</b> (Quantity) Oxygen: <input type="text"/> Medical Air: <input type="text"/> Medical Vacuum: <input type="text"/> Nitrous Oxide: <input type="text"/> CO2: <input type="text"/> AGSS: <input type="text"/> Nitrogen: <input type="text"/> Laboratory Air: <input type="text"/> Laboratory Vacuum: <input type="text"/> Utility Compressed Air: <input type="text"/>					
Plumbing Remarks: <input type="text"/>		Gas Remarks: <input type="text"/>									

**Appendix 1B Minimum Room Requirements**

Room Name:

Program Number(s):

1. C2.14	7.	13.	19.	25.	31.	37.	43.
2. C8.05	8.	14.	20.	26.	32.	38.	44.
3. D7.13	9.	15.	21.	27.	33.	39.	45.
4. Y1.10	10.	16.	22.	28.	34.	40.	46.
5.	11.	17.	23.	29.	35.	41.	47.
6.	12.	18.	24.	30.	36.	42.	48.

**ARCHITECTURAL REQUIREMENTS**

<b>WALL AND CEILING</b> Wall Material: <input type="text" value="MMRGB"/> Finish: <input type="text" value="HPC"/> Ceiling Material: <input type="text" value="MMRGB"/> Finish: <input type="text" value="HPC"/>		<b>WALL PROTECTION</b> Type: <input type="text" value="WSSP"/> <input checked="" type="checkbox"/> Corner Guards <input type="checkbox"/> Hand Rails <input type="checkbox"/> Bed Bumper / Locator Height: <input type="text" value="2185 mm"/> <input type="checkbox"/> Crash Rails <input type="checkbox"/> Chair Rail		<b>GLAZING</b> <input type="checkbox"/> Interior Glazing		<b>FLOORING TYPES</b> Material: <input type="text" value="WSVF"/> Base: <input type="text" value="FCB"/>		<b>ROOM ACCESSORIES</b> <input checked="" type="checkbox"/> Coat Hooks <input type="checkbox"/> Ceiling Lift <input type="checkbox"/> Magnetic Whiteboard <input checked="" type="checkbox"/> Mirror <input type="checkbox"/> Infant Change Table <input type="checkbox"/> Privacy Curtain	
--	--	--	--	---	--	---	--	--	--

- LEGEND:**
- WALL AND CEILING LEGEND:**
- AC Architectural Ceiling
  - ACT Acoustic Ceiling Tile
  - ACT-C Cleanroom
  - ARGB Abuse-Resistant Gypsum Board
  - GB Gypsum Board
  - IRGB Impact-Resistant Gypsum Board
  - KLCT Kitchen Lay-in Ceiling Tile
  - MMRGB Moisture and Mould-Resistant Gypsum Board
  - SACT Security Acoustic Ceiling Tile
- WALL FINISHES LEGEND:**
- EWC Epoxy Wall Coating
  - HPC High Performance Coating
  - PT Paint
- CEILING FINISHES LEGEND:**
- ECC Epoxy Ceiling Coating
  - HPC High Performance Coating
  - PF Prefinished
  - PT Paint
- WALL PROTECTION LEGEND:**
- ESRP Extruded Semi-Rigid PVCu Panel
  - FRL Fibre Reinforced Laminate
  - FRP Fibreglass Reinforced Plastic
  - PVV Protective Vinyl Wallcovering
  - RHIS Rigid High Impact Sheet
  - WSSP Wetwall Solid Surface Panel
  - WVV Wetroom Vinyl Wallcovering
- FLOOR FINISHES LEGEND:**
- CFS Concrete Floor Sealer
  - EFC Epoxy Floor Coating
  - PFC Polyurethane Floor Coating
  - RAF Rubber Athletic Flooring
  - RSF Rubber Sheet Flooring
  - SCF Seamless Cushioned Flooring
  - SDRF Static-Dissipative Rubber Sheet Flooring
  - SDVF Static-Dissipative Vinyl Sheet Flooring
  - VSF Vinyl Sheet Flooring
  - WSVF Wetroom Safety Vinyl Sheet Flooring
- FLOOR BASE LEGEND:**
- FCB Flash Cove Base
  - RB Rubber Base
  - SCF Seamless Cushioned Flooring

**DOORS**

Types:

Type	Qty	Size (mm)	Material	Finish	Side Lt.	Blinds	Protect.	Film	Function	Card Reader	Mag Lock	Auto Opener	Hold Open	Hinges	Accessory 1	Accessory 2	Accessory 3	Closer
A	1	1065 x 2135	Solid Core	FRL	<input type="checkbox"/>	<input type="checkbox"/>	1 Low	<input type="checkbox"/>	Privacy	<input type="checkbox"/>	<input type="checkbox"/>	<input type="checkbox"/>	<input type="checkbox"/>	Cont. Double-Acting	Safety Stop			Surface

**Door Remarks:**

Security Grille  
 Anti-barricade strategy

**MILLWORK AND SPECIALTY CASEWORK**

Storage Requirements:

**UPPER UNITS** (U1-U8)

**LOWER UNITS** (L1-L12)

**RECEPTION/TRANSACTION COUNTER / CARE TEAM STATION DESK** (TC1, TC2)

**UTILITY SINK AND COUNTER UNIT** (UC1)

**SHELF** (S1)

**FULL-HEIGHT CABINETS** (C1-C5)

**Legend:**

Category	Min. Length (mm)	Motorized Adjustable Height	Standing Height	Specialty Casework
Category 0 - None				
Category 1 - Low (1% - 4%)				
Category 2 - Med (5% - 9%)				
Category 3 - High (10% or Greater)				

**FINISHES**

Full-height Cabinet:   
 Upper Millwork:   
 Countertop:   
 Lower Millwork:   
 Shelf:

**Remarks:**

**MECHANICAL REQUIREMENTS**

**PLUMBING**

Hand Hygiene Sink:	Laundry:	Kitchen Sink:	Seamless Kitchen Sink:	Utility / Process Sink:	Scrub Sink:	Floor Sink:
<input type="text"/>	<input type="text" value="1"/>	<input type="text"/>	<input type="text"/>	<input type="text"/>	<input type="text"/>	<input type="text"/>

Plumbing Remarks:

**Other Fixtures:**

- Shower
- Tub
- Ice Maker
- Water Closet
- Instantaneous Hot Water
- Eyewash Station
- Eyewash/Shower Station
- Emergency Shower
- Flush Rim Sink
- Floor Drain
- Water Bottle Refill Station

Other:

**MED / NON-MED GASES**

Oxygen:	Medical Air:	Medical Vacuum:	Nitrous Oxide:	CO2:	AGSS:	Nitrogen:	Laboratory Air:	Laboratory Vacuum:	Utility Compressed Air:
<input type="text"/>	<input type="text"/>	<input type="text"/>	<input type="text"/>	<input type="text"/>	<input type="text"/>	<input type="text"/>	<input type="text"/>	<input type="text"/>	<input type="text"/>

Gas Remarks:



**Appendix 1B Minimum Room Requirements**

Room Name:

Program Number(s):

1. C7.04	7.	13.	19.	25.	31.	37.	43.
2. F2.14	8.	14.	20.	26.	32.	38.	44.
3. F3.09	9.	15.	21.	27.	33.	39.	45.
4. F4.09	10.	16.	22.	28.	34.	40.	46.
5. F5.14	11.	17.	23.	29.	35.	41.	47.
6.	12.	18.	24.	30.	36.	42.	48.

**ARCHITECTURAL REQUIREMENTS**

<b>WALL AND CEILING</b> Wall Material: <input type="text" value="GB"/> Finish: <input type="text" value="PT"/> Ceiling Material: <input type="text" value="ACT"/> Finish: <input type="text" value="PF"/>		<b>WALL PROTECTION</b> Type: <input type="text" value="PVW"/> <input type="checkbox"/> Corner Guards <input type="checkbox"/> Hand Rails <input type="checkbox"/> Bed Bumper / Locator Height: <input type="text" value="1350 mm"/> <input type="checkbox"/> Crash Rails <input type="checkbox"/> Chair Rail		<b>GLAZING</b> <input type="checkbox"/> Interior Glazing		<b>FLOORING TYPES</b> Material: <input type="text" value="VSF"/> Base: <input type="text" value="FCB"/>		<b>ROOM ACCESSORIES</b> <input type="checkbox"/> Coat Hooks <input type="checkbox"/> Ceiling Lift <input checked="" type="checkbox"/> Magnetic Whiteboard <input type="checkbox"/> Mirror <input type="checkbox"/> Infant Change Table <input type="checkbox"/> Privacy Curtain	
---	--	--	--	---	--	--	--	---	--

- LEGEND:**
- WALL AND CEILING LEGEND:**
- AC Architectural Ceiling
  - ACT Acoustic Ceiling Tile
  - ACT-C Cleanroom
  - ARGB Abuse-Resistant Gypsum Board
  - GB Gypsum Board
  - IRGB Impact-Resistant Gypsum Board
  - KLCT Kitchen Lay-in Ceiling Tile
  - MMRGB Moisture and Mould-Resistant Gypsum Board
  - SACT Security Acoustic Ceiling Tile
- WALL FINISHES LEGEND:**
- EWC Epoxy Wall Coating
  - HPC High Performance Coating
  - PT Paint
- CEILING FINISHES LEGEND:**
- ECC Epoxy Ceiling Coating
  - HPC High Performance Coating
  - PF Prefinished
  - PT Paint
- WALL PROTECTION LEGEND:**
- ESRP Extruded Semi-Rigid PVCu Panel
  - FRL Fibre Reinforced Laminate
  - FRP Fibreglass Reinforced Plastic
  - PVW Protective Vinyl Wallcovering
  - RHIS Rigid High Impact Sheet
  - WSSP Wetwall Solid Surface Panel
  - WVV Wetroom Vinyl Wallcovering
- FLOOR FINISHES LEGEND:**
- CFS Concrete Floor Sealer
  - EFC Epoxy Floor Coating
  - PFC Polyurethane Floor Coating
  - RAF Rubber Athletic Flooring
  - RSF Rubber Sheet Flooring
  - SCF Seamless Cushioned Flooring
  - SDRF Static-Dissipative Rubber Sheet Flooring
  - SDVF Static-Dissipative Vinyl Sheet Flooring
  - VSF Vinyl Sheet Flooring
  - WSVF Wetroom Safety Vinyl Sheet Flooring
- FLOOR BASE LEGEND:**
- FCB Flash Cove Base
  - RB Rubber Base
  - SCF Seamless Cushioned Flooring

**DOORS**

Types:

Type	Qty	Size (mm)	Material	Finish	Side Lt.	Blinds	Protect.	Privacy Film	Function	Card Reader	Mag Lock	Auto Opener	Hold Open	Hinges	Accessory 1	Accessory 2	Accessory 3	Closer
C	1	915 x 2135	Solid Core	FRL	<input checked="" type="checkbox"/>	<input type="checkbox"/>	2 High	<input type="checkbox"/>	Storeroom	<input checked="" type="checkbox"/>	<input type="checkbox"/>	<input type="checkbox"/>	<input type="checkbox"/>	Butt Hinge				Surface

Door Remarks: Quantities of door is dependent on design

Security Grille  
 Anti-barricade strategy

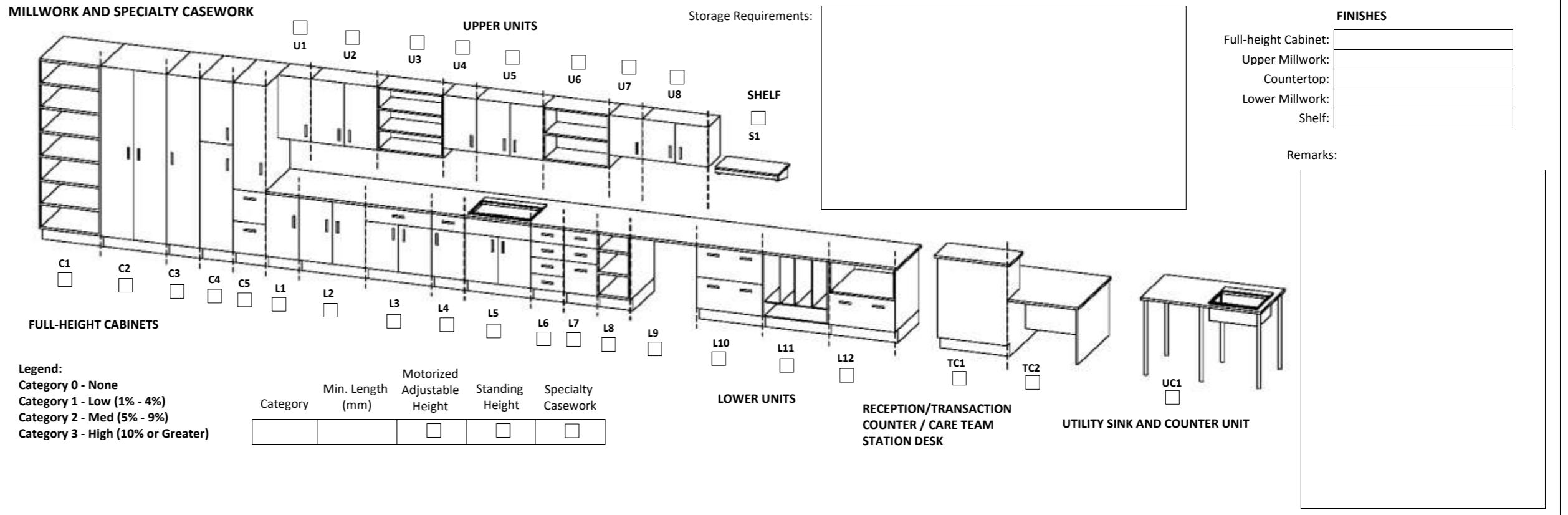

**MECHANICAL REQUIREMENTS**

<b>PLUMBING</b> (Quantity) Hand Hygiene Sink: <input type="text"/> Lavatory: <input type="text"/> Kitchen Sink: <input type="text"/> Seamless Kitchen Sink: <input type="text"/> Utility / Process Sink: <input type="text"/> Scrub Sink: <input type="text"/> Floor Sink: <input type="text"/>							Other Fixtures: <input type="checkbox"/> Shower <input type="checkbox"/> Tub <input type="checkbox"/> Ice Maker <input type="checkbox"/> Water Closet <input type="checkbox"/> Instantaneous Hot Water			<input type="checkbox"/> Eyewash Station <input type="checkbox"/> Eyewash/Shower Station <input type="checkbox"/> Emergency Shower <input type="checkbox"/> Flush Rim Sink <input type="checkbox"/> Floor Drain <input type="checkbox"/> Water Bottle Refill Station			<b>MED / NON-MED GASES</b> (Quantity) Oxygen: <input type="text"/> Medical Air: <input type="text"/> Medical Vacuum: <input type="text"/> Nitrous Oxide: <input type="text"/> CO2: <input type="text"/> AGSS: <input type="text"/> Nitrogen: <input type="text"/> Laboratory Air: <input type="text"/> Laboratory Vacuum: <input type="text"/> Utility Compressed Air: <input type="text"/>				
Plumbing Remarks: <input type="text"/>							Other: <input type="text"/>			Gas Remarks: <input type="text"/>							

# Appendix 1B Minimum Room Requirements

Room Name:

Program Number(s):

1.	U3.02	7.		13.		19.		25.		31.		37.		43.
2.		8.		14.		20.		26.		32.		38.		44.
3.		9.		15.		21.		27.		33.		39.		45.
4.		10.		16.		22.		28.		34.		40.		46.
5.		11.		17.		23.		29.		35.		41.		47.
6.		12.		18.		24.		30.		36.		42.		48.

## ARCHITECTURAL REQUIREMENTS

<b>WALL AND CEILING</b> Wall Material: <input type="text" value="ARGB 1.2m AFF, GB above"/> Finish: <input type="text" value="PT"/> Ceiling Material: <input type="text" value="ACT"/> Finish: <input type="text" value="PF"/>	<b>WALL PROTECTION</b> Type: <input type="text" value="PVW"/> <input checked="" type="checkbox"/> Corner Guards <input type="checkbox"/> Hand Rails <input type="checkbox"/> Bed Bumper / Locator Height: <input type="text" value="1350 mm"/> <input type="checkbox"/> Crash Rails <input checked="" type="checkbox"/> Chair Rail	<b>GLAZING</b> <input checked="" type="checkbox"/> Interior Glazing	<b>FLOORING TYPES</b> Material: <input type="text" value="VSF"/> Base: <input type="text" value="RB"/>	<b>ROOM ACCESSORIES</b> <input checked="" type="checkbox"/> Coat Hooks <input type="checkbox"/> Ceiling Lift <input checked="" type="checkbox"/> Magnetic Whiteboard <input type="checkbox"/> Mirror <input type="checkbox"/> Infant Change Table <input type="checkbox"/> Privacy Curtain
--	--	--	---	--

- LEGEND:**
- WALL AND CEILING LEGEND:**
- AC Architectural Ceiling
  - ACT Acoustic Ceiling Tile
  - ACT-C Cleanroom
  - ARGB Abuse-Resistant Gypsum Board
  - GB Gypsum Board
  - IRGB Impact-Resistant Gypsum Board
  - KLCT Kitchen Lay-in Ceiling Tile
  - MMRGB Moisture and Mould-Resistant Gypsum Board
  - SACT Security Acoustic Ceiling Tile
- WALL FINISHES LEGEND:**
- EWC Epoxy Wall Coating
  - HPC High Performance Coating
  - PT Paint
- CEILING FINISHES LEGEND:**
- ECC Epoxy Ceiling Coating
  - HPC High Performance Coating
  - PF Prefinished
  - PT Paint
- WALL PROTECTION LEGEND:**
- ESRP Extruded Semi-Rigid PVCu Panel
  - FRL Fibre Reinforced Laminate
  - FRP Fibreglass Reinforced Plastic
  - PVW Protective Vinyl Wallcovering
  - RHIS Rigid High Impact Sheet
  - WSSP Wetwall Solid Surface Panel
  - WVV Wetroom Vinyl Wallcovering
- FLOOR FINISHES LEGEND:**
- CFS Concrete Floor Sealer
  - EFC Epoxy Floor Coating
  - PFC Polyurethane Floor Coating
  - RAF Rubber Athletic Flooring
  - RSF Rubber Sheet Flooring
  - SCF Seamless Cushioned Flooring
  - SDRF Static-Dissipative Rubber Sheet Flooring
  - SDVF Static-Dissipative Vinyl Sheet Flooring
  - VSF Vinyl Sheet Flooring
  - WSVF Wetroom Safety Vinyl Sheet Flooring
- FLOOR BASE LEGEND:**
- FCB Flash Cove Base
  - RB Rubber Base
  - SCF Seamless Cushioned Flooring

**DOORS**

Types:

Type	Qty	Size (mm)	Material	Finish	Side Lt.	Blinds	Protect.	Privacy Film	Function	Card Reader	Mag Lock	Auto Opener	Hold Open	Hinges	Accessory 1	Accessory 2	Accessory 3	Closer
B	1	915 x 2135	Solid Core	FRL	<input type="checkbox"/>	<input type="checkbox"/>	1 Low	<input type="checkbox"/>	Storeroom	<input checked="" type="checkbox"/>	<input type="checkbox"/>	<input type="checkbox"/>	<input type="checkbox"/>	Butt Hinge				Surface

Door Remarks:  Security Grille  Anti-barricade strategy



## MECHANICAL REQUIREMENTS

<b>PLUMBING</b> (Quantity) Hand Hygiene Sink: <input type="text"/> Lavatory: <input type="text"/> Kitchen Sink: <input type="text"/> Seamless Kitchen Sink: <input type="text"/> Utility / Process Sink: <input type="text"/> Scrub Sink: <input type="text"/> Floor Sink: <input type="text"/> Plumbing Remarks: <input type="text"/>	Other Fixtures: <input type="checkbox"/> Shower <input type="checkbox"/> Eyewash Station <input type="checkbox"/> Tub <input type="checkbox"/> Eyewash/Shower Station <input type="checkbox"/> Ice Maker <input type="checkbox"/> Emergency Shower <input type="checkbox"/> Water Closet <input type="checkbox"/> Flush Rim Sink <input type="checkbox"/> Instantaneous Hot Water <input type="checkbox"/> Floor Drain <input type="checkbox"/> <input type="checkbox"/> Water Bottle Refill Station Other: <input type="text"/>	<b>MED / NON-MED GASES</b> (Quantity) Oxygen: <input type="text"/> Medical Air: <input type="text"/> Medical Vacuum: <input type="text"/> Nitrous Oxide: <input type="text"/> CO2: <input type="text"/> AGSS: <input type="text"/> Nitrogen: <input type="text"/> Laboratory Air: <input type="text"/> Laboratory Vacuum: <input type="text"/> Utility Compressed Air: <input type="text"/> Gas Remarks: <input type="text"/>
---	---	---

**Appendix 1B Minimum Room Requirements**

Room Name:

Program Number(s):	1. Y4.02	7.	13.	19.	25.	31.	37.	43.
	2.	8.	14.	20.	26.	32.	38.	44.
	3.	9.	15.	21.	27.	33.	39.	45.
	4.	10.	16.	22.	28.	34.	40.	46.
	5.	11.	17.	23.	29.	35.	41.	47.
	6.	12.	18.	24.	30.	36.	42.	48.

**ARCHITECTURAL REQUIREMENTS**

<b>WALL AND CEILING</b> Wall Material: <input type="text" value="ARGB 1.2m AFF, GB above"/> Finish: <input type="text" value="PT"/> Ceiling Material: <input type="text" value="ACT"/> Finish: <input type="text" value="PF"/>	<b>WALL PROTECTION</b> Type: <input type="text" value="PVW"/> <input checked="" type="checkbox"/> Corner Guards <input type="checkbox"/> Hand Rails <input type="checkbox"/> Bed Bumper / Locator Height: <input type="text" value="1350 mm"/> <input type="checkbox"/> Crash Rails <input checked="" type="checkbox"/> Chair Rail	<b>GLAZING</b> <input checked="" type="checkbox"/> Interior Glazing	<b>FLOORING TYPES</b> Material: <input type="text" value="VSF"/> Base: <input type="text" value="RB"/>	<b>ROOM ACCESSORIES</b> <input checked="" type="checkbox"/> Coat Hooks <input type="checkbox"/> Ceiling Lift <input checked="" type="checkbox"/> Magnetic Whiteboard <input type="checkbox"/> Mirror <input type="checkbox"/> Infant Change Table <input type="checkbox"/> Privacy Curtain
--	--	--	---	--

- LEGEND:**
- WALL AND CEILING LEGEND:**
- AC Architectural Ceiling
  - ACT Acoustic Ceiling Tile
  - ACT-C Cleanroom
  - ARGB Abuse-Resistant Gypsum Board
  - GB Gypsum Board
  - IRGB Impact-Resistant Gypsum Board
  - KLCT Kitchen Lay-in Ceiling Tile
  - MMRGB Moisture and Mould-Resistant Gypsum Board
  - SACT Security Acoustic Ceiling Tile
- WALL FINISHES LEGEND:**
- EWC Epoxy Wall Coating
  - HPC High Performance Coating
  - PT Paint
- CEILING FINISHES LEGEND:**
- ECC Epoxy Ceiling Coating
  - HPC High Performance Coating
  - PF Prefinished
  - PT Paint
- WALL PROTECTION LEGEND:**
- ESRP Extruded Semi-Rigid PVCu Panel
  - FRL Fibre Reinforced Laminate
  - FRP Fibreglass Reinforced Plastic
  - PVW Protective Vinyl Wallcovering
  - RHIS Rigid High Impact Sheet
  - WSSP Wetwall Solid Surface Panel
  - WVV Wetroom Vinyl Wallcovering
- FLOOR FINISHES LEGEND:**
- CFS Concrete Floor Sealer
  - EFC Epoxy Floor Coating
  - PFC Polyurethane Floor Coating
  - RAF Rubber Athletic Flooring
  - RSF Rubber Sheet Flooring
  - SCF Seamless Cushioned Flooring
  - SDRF Static-Dissipative Rubber Sheet Flooring
  - SDVF Static-Dissipative Vinyl Sheet Flooring
  - VSF Vinyl Sheet Flooring
  - WSVF Wetroom Safety Vinyl Sheet Flooring
- FLOOR BASE LEGEND:**
- FCB Flash Cove Base
  - RB Rubber Base
  - SCF Seamless Cushioned Flooring

**DOORS**

Types:

Type	Qty	Size (mm)	Material	Finish	Side Lt.	Blinds	Protect.	Privacy Film	Function	Card Reader	Mag Lock	Auto Opener	Hold Open	Hinges	Accessory 1	Accessory 2	Accessory 3	Closer
B2	1	1830 x 2440	Solid Core	FRL	<input type="checkbox"/>	<input type="checkbox"/>	2 High	<input type="checkbox"/>	Storeroom	<input checked="" type="checkbox"/>	<input type="checkbox"/>	<input type="checkbox"/>	<input type="checkbox"/>	Butt Hinge	Astragal	Flush Bolt		Surface

Door Remarks:  Security Grille  Anti-barricade strategy

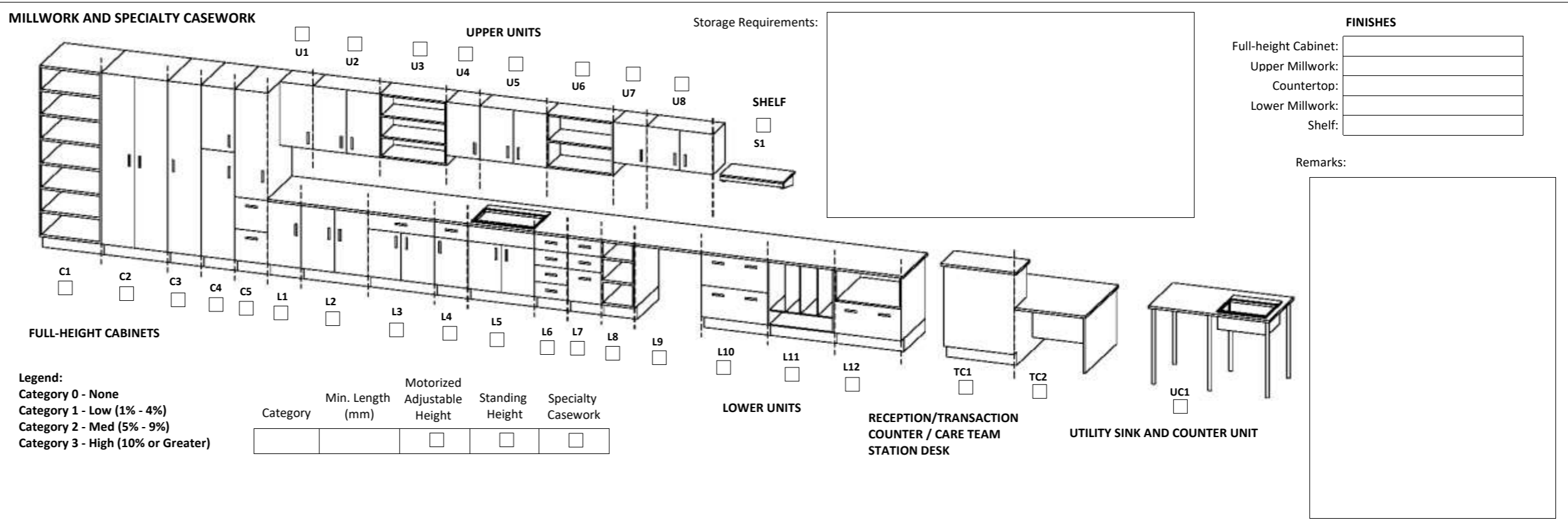

**MECHANICAL REQUIREMENTS**

<b>PLUMBING</b> (Quantity) Hand Hygiene Sink: <input type="text"/> Lavatory: <input type="text"/> Kitchen Sink: <input type="text"/> Seamless Kitchen Sink: <input type="text"/> Utility / Process Sink: <input type="text"/> Scrub Sink: <input type="text"/> Floor Sink: <input type="text"/> Plumbing Remarks: <input type="text"/>	Other Fixtures: <input type="checkbox"/> Shower <input type="checkbox"/> Eyewash Station <input type="checkbox"/> Tub <input type="checkbox"/> Eyewash/Shower Station <input type="checkbox"/> Ice Maker <input type="checkbox"/> Emergency Shower <input type="checkbox"/> Water Closet <input type="checkbox"/> Flush Rim Sink <input type="checkbox"/> Instantaneous Hot Water <input type="checkbox"/> Floor Drain <input type="checkbox"/> <input type="checkbox"/> Water Bottle Refill Station Other <input type="text"/>	<b>MED / NON-MED GASES</b> (Quantity) Oxygen: <input type="text"/> Medical Air: <input type="text"/> Medical Vacuum: <input type="text"/> Nitrous Oxide: <input type="text"/> CO2: <input type="text"/> AGSS: <input type="text"/> Nitrogen: <input type="text"/> Laboratory Air: <input type="text"/> Laboratory Vacuum: <input type="text"/> Utility Compressed Air: <input type="text"/> Gas Remarks: <input type="text"/>
---	--	---



# Appendix 1B Minimum Room Requirements

Room Name:

Program Number(s):	1. U2.02	7.	13.	19.	25.	31.	37.	43.
	2.	8.	14.	20.	26.	32.	38.	44.
	3.	9.	15.	21.	27.	33.	39.	45.
	4.	10.	16.	22.	28.	34.	40.	46.
	5.	11.	17.	23.	29.	35.	41.	47.
	6.	12.	18.	24.	30.	36.	42.	48.

## ARCHITECTURAL REQUIREMENTS

<b>WALL AND CEILING</b> Wall Material: <input type="text" value="ARGB 1.2m AFF, GB above"/> Finish: <input type="text" value="PT"/> Ceiling Material: <input type="text" value="ACT"/> Finish: <input type="text" value="PF"/>	<b>WALL PROTECTION</b> Type: <input type="text" value="PVW"/> <input checked="" type="checkbox"/> Corner Guards <input type="checkbox"/> Hand Rails <input type="checkbox"/> Bed Bumper / Locator Height: <input type="text" value="1350 mm"/> <input type="checkbox"/> Crash Rails <input checked="" type="checkbox"/> Chair Rail	<b>GLAZING</b> <input checked="" type="checkbox"/> Interior Glazing	<b>FLOORING TYPES</b> Material: <input type="text" value="VSF"/> Base: <input type="text" value="RB"/>	<b>ROOM ACCESSORIES</b> <input checked="" type="checkbox"/> Coat Hooks <input type="checkbox"/> Ceiling Lift <input checked="" type="checkbox"/> Magnetic Whiteboard <input type="checkbox"/> Mirror <input type="checkbox"/> Infant Change Table <input type="checkbox"/> Privacy Curtain
--	--	--	---	--

- LEGEND:**
- WALL AND CEILING LEGEND:**
- AC Architectural Ceiling
  - ACT Acoustic Ceiling Tile
  - ACT-C Cleanroom
  - ARGB Abuse-Resistant Gypsum Board
  - GB Gypsum Board
  - IRGB Impact-Resistant Gypsum Board
  - KLCT Kitchen Lay-in Ceiling Tile
  - MMRGB Moisture and Mould-Resistant Gypsum Board
  - SACT Security Acoustic Ceiling Tile
- WALL FINISHES LEGEND:**
- EWC Epoxy Wall Coating
  - HPC High Performance Coating
  - PT Paint
- CEILING FINISHES LEGEND:**
- ECC Epoxy Ceiling Coating
  - HPC High Performance Coating
  - PF Prefinished
  - PT Paint
- WALL PROTECTION LEGEND:**
- ESRP Extruded Semi-Rigid PVCu Panel
  - FRL Fibre Reinforced Laminate
  - FRP Fibreglass Reinforced Plastic
  - PVW Protective Vinyl Wallcovering
  - RHIS Rigid High Impact Sheet
  - WSSP Wetwall Solid Surface Panel
  - WVV Wetroom Vinyl Wallcovering
- FLOOR FINISHES LEGEND:**
- CFS Concrete Floor Sealer
  - EFC Epoxy Floor Coating
  - PFC Polyurethane Floor Coating
  - RAF Rubber Athletic Flooring
  - RSF Rubber Sheet Flooring
  - SCF Seamless Cushioned Flooring
  - SDRF Static-Dissipative Rubber Sheet Flooring
  - SDVF Static-Dissipative Vinyl Sheet Flooring
  - VSF Vinyl Sheet Flooring
  - WSVF Wetroom Safety Vinyl Sheet Flooring
- FLOOR BASE LEGEND:**
- FCB Flash Cove Base
  - RB Rubber Base
  - SCF Seamless Cushioned Flooring

**DOORS**

Types:

Type:Qty:	Size (mm):	Material:	Finish:	Side Lt:	Blinds:	Protect.:	Privacy Film:	Function:	Card Reader:	Mag Lock:	Auto Opener:	Hold Open:	Hinges:	Accessory 1:	Accessory 2:	Accessory 3:	Closer:
								Storeroom	<input checked="" type="checkbox"/>	<input type="checkbox"/>	<input type="checkbox"/>	<input type="checkbox"/>	Butt Hinge				Surface

Door Remarks:  Security Grille  Anti-barricade strategy

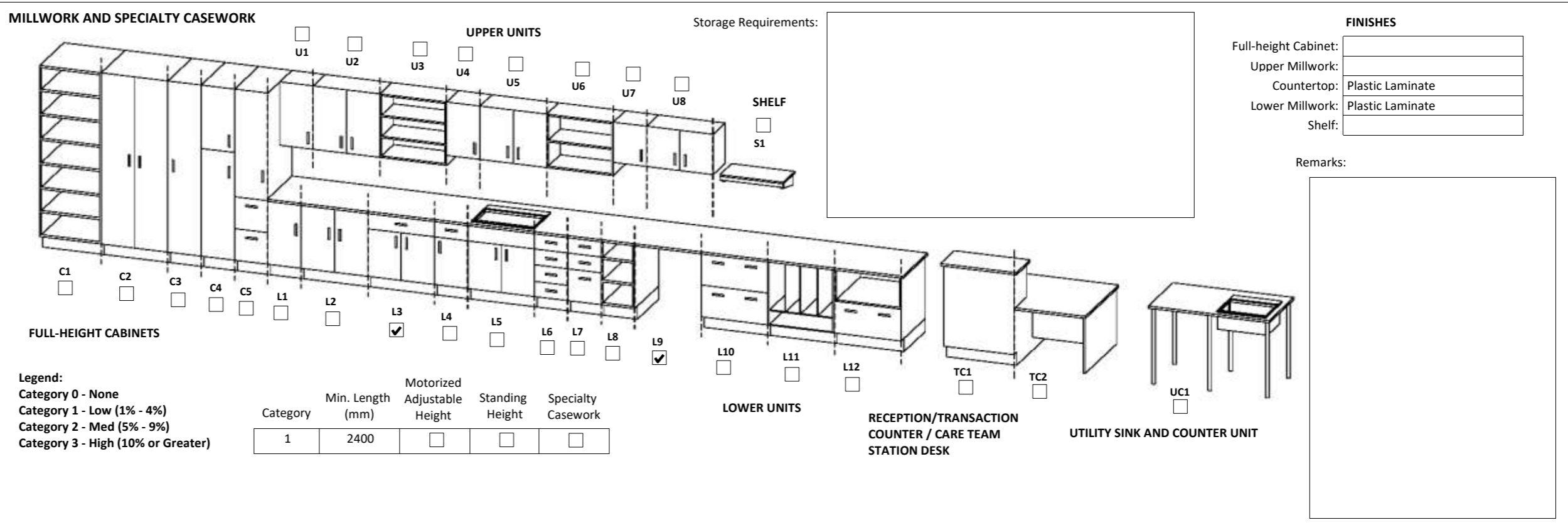

## MECHANICAL REQUIREMENTS

<b>PLUMBING</b> (Quantity) Hand Hygiene Sink: <input type="text"/> Lavatory: <input type="text"/> Kitchen Sink: <input type="text"/> Seamless Kitchen Sink: <input type="text"/> Utility / Process Sink: <input type="text"/> Scrub Sink: <input type="text"/> Floor Sink: <input type="text"/> Plumbing Remarks: <input type="text"/>	Other Fixtures: <input type="checkbox"/> Shower <input type="checkbox"/> Eyewash Station <input type="checkbox"/> Tub <input type="checkbox"/> Eyewash/Shower Station <input type="checkbox"/> Ice Maker <input type="checkbox"/> Emergency Shower <input type="checkbox"/> Water Closet <input type="checkbox"/> Flush Rim Sink <input type="checkbox"/> Instantaneous Hot Water <input type="checkbox"/> Floor Drain <input type="checkbox"/> <input type="checkbox"/> Water Bottle Refill Station Other: <input type="text"/>	<b>MED / NON-MED GASES</b> (Quantity) Oxygen: <input type="text"/> Medical Air: <input type="text"/> Medical Vacuum: <input type="text"/> Nitrous Oxide: <input type="text"/> CO2: <input type="text"/> AGSS: <input type="text"/> Nitrogen: <input type="text"/> Laboratory Air: <input type="text"/> Laboratory Vacuum: <input type="text"/> Utility Compressed Air: <input type="text"/> Gas Remarks: <input type="text"/>
---	---	---

**Appendix 1B Minimum Room Requirements**

Room Name:

Program Number(s):

1. U5.07	7.	13.	19.	25.	31.	37.	43.
2.	8.	14.	20.	26.	32.	38.	44.
3.	9.	15.	21.	27.	33.	39.	45.
4.	10.	16.	22.	28.	34.	40.	46.
5.	11.	17.	23.	29.	35.	41.	47.
6.	12.	18.	24.	30.	36.	42.	48.

**ARCHITECTURAL REQUIREMENTS**

<b>WALL AND CEILING</b> Wall Material: <input type="text" value="ARGB 1.2m AFF, GB above"/> Finish: <input type="text" value="PT"/> Ceiling Material: <input type="text" value="ACT"/> Finish: <input type="text" value="PF"/>	<b>WALL PROTECTION</b> Type: <input type="text" value="PVW"/> <input checked="" type="checkbox"/> Corner Guards <input type="checkbox"/> Hand Rails <input type="checkbox"/> Bed Bumper / Locator Height: <input type="text" value="1350 mm"/> <input type="checkbox"/> Crash Rails <input checked="" type="checkbox"/> Chair Rail	<b>GLAZING</b> <input checked="" type="checkbox"/> Interior Glazing	<b>FLOORING TYPES</b> Material: <input type="text" value="VSF"/> Base: <input type="text" value="RB"/>	<b>ROOM ACCESSORIES</b> <input checked="" type="checkbox"/> Coat Hooks <input type="checkbox"/> Ceiling Lift <input checked="" type="checkbox"/> Magnetic Whiteboard <input type="checkbox"/> Mirror <input type="checkbox"/> Infant Change Table <input type="checkbox"/> Privacy Curtain
--	--	--	---	--

- LEGEND:**
- WALL AND CEILING LEGEND:**
- AC Architectural Ceiling
  - ACT Acoustic Ceiling Tile
  - ACT-C Cleanroom
  - ARGB Abuse-Resistant Gypsum Board
  - GB Gypsum Board
  - IRGB Impact-Resistant Gypsum Board
  - KLCT Kitchen Lay-in Ceiling Tile
  - MMRGB Moisture and Mould-Resistant Gypsum Board
  - SACT Security Acoustic Ceiling Tile
- WALL FINISHES LEGEND:**
- EWC Epoxy Wall Coating
  - HPC High Performance Coating
  - PT Paint
- CEILING FINISHES LEGEND:**
- ECC Epoxy Ceiling Coating
  - HPC High Performance Coating
  - PF Prefinished
  - PT Paint
- WALL PROTECTION LEGEND:**
- ESRP Extruded Semi-Rigid PVCu Panel
  - FRL Fibre Reinforced Laminate
  - FRP Fibreglass Reinforced Plastic
  - PVW Protective Vinyl Wallcovering
  - RHIS Rigid High Impact Sheet
  - WSSP Wetwall Solid Surface Panel
  - WVV Wetroom Vinyl Wallcovering
- FLOOR FINISHES LEGEND:**
- CFS Concrete Floor Sealer
  - EFC Epoxy Floor Coating
  - PFC Polyurethane Floor Coating
  - RAF Rubber Athletic Flooring
  - RSF Rubber Sheet Flooring
  - SCF Seamless Cushioned Flooring
  - SDRF Static-Dissipative Rubber Sheet Flooring
  - SDVF Static-Dissipative Vinyl Sheet Flooring
  - VSF Vinyl Sheet Flooring
  - WSVF Wetroom Safety Vinyl Sheet Flooring
- FLOOR BASE LEGEND:**
- FCB Flash Cove Base
  - RB Rubber Base
  - SCF Seamless Cushioned Flooring

**DOORS**

Types:

Type	Qty	Size (mm)	Material	Finish	Side Lt.	Blinds	Protect.	Privacy Film	Function	Card Reader	Mag Lock	Auto Opener	Hold Open	Hinges	Accessory 1	Accessory 2	Accessory 3	Closer
B	1	915 x 2135	Solid Core	FRL	<input type="checkbox"/>	<input type="checkbox"/>	1 Low	<input type="checkbox"/>	Storeroom	<input checked="" type="checkbox"/>	<input type="checkbox"/>	<input type="checkbox"/>	<input type="checkbox"/>	Butt Hinge				Surface

Door Remarks:  Security Grille  Anti-barricade strategy

**MILLWORK AND SPECIALTY CASEWORK**

**UPPER UNITS** (U1-U8) **LOWER UNITS** (L1-L9)

**RECEPTION/TRANSACTION COUNTER / CARE TEAM STATION DESK** (TC1, TC2)

**UTILITY SINK AND COUNTER UNIT** (UC1)

**Storage Requirements:**  SHELF (S1)

Category	Min. Length (mm)	Motorized Adjustable Height	Standing Height	Specialty Casework
1	2400	<input type="checkbox"/>	<input type="checkbox"/>	<input type="checkbox"/>

**FINISHES**

Full-height Cabinet:

Upper Millwork:

Countertop:

Lower Millwork:

Shelf:

Remarks:

**MECHANICAL REQUIREMENTS**

<b>PLUMBING</b> (Quantity) Hand Hygiene Sink: <input type="text"/> Lavatory: <input type="text"/> Kitchen Sink: <input type="text"/> Seamless Kitchen Sink: <input type="text"/> Utility / Process Sink: <input type="text"/> Scrub Sink: <input type="text"/> Floor Sink: <input type="text"/> Plumbing Remarks: <input type="text"/>	Other Fixtures: <input type="checkbox"/> Shower <input type="checkbox"/> Eyewash Station <input type="checkbox"/> Tub <input type="checkbox"/> Eyewash/Shower Station <input type="checkbox"/> Ice Maker <input type="checkbox"/> Emergency Shower <input type="checkbox"/> Water Closet <input type="checkbox"/> Flush Rim Sink <input type="checkbox"/> Instantaneous Hot Water <input type="checkbox"/> Floor Drain <input type="checkbox"/> <input type="checkbox"/> Water Bottle Refill Station Other: <input type="text"/>	<b>MED / NON-MED GASES</b> (Quantity) Oxygen: <input type="text"/> Medical Air: <input type="text"/> Medical Vacuum: <input type="text"/> Nitrous Oxide: <input type="text"/> CO2: <input type="text"/> AGSS: <input type="text"/> Nitrogen: <input type="text"/> Laboratory Air: <input type="text"/> Laboratory Vacuum: <input type="text"/> Utility Compressed Air: <input type="text"/> Gas Remarks: <input type="text"/>
---	---	--

**Appendix 1B Minimum Room Requirements**

Room Name:

Program Number(s):

1. L1.03	7.	13.	19.	25.	31.	37.	43.
2. M2.03	8.	14.	20.	26.	32.	38.	44.
3.	9.	15.	21.	27.	33.	39.	45.
4.	10.	16.	22.	28.	34.	40.	46.
5.	11.	17.	23.	29.	35.	41.	47.
6.	12.	18.	24.	30.	36.	42.	48.

**ARCHITECTURAL REQUIREMENTS**

<b>WALL AND CEILING</b> Wall Material: <input type="text" value="ARGB 1.2m AFF, GB above"/> Finish: <input type="text" value="PT"/> Ceiling Material: <input type="text" value="ACT"/> Finish: <input type="text" value="PF"/>	<b>WALL PROTECTION</b> Type: <input type="text" value="PVW"/> <input checked="" type="checkbox"/> Corner Guards <input type="checkbox"/> Hand Rails <input type="checkbox"/> Bed Bumper / Locator Height: <input type="text" value="1350 mm"/> <input type="checkbox"/> Crash Rails <input checked="" type="checkbox"/> Chair Rail	<b>GLAZING</b> <input checked="" type="checkbox"/> Interior Glazing	<b>FLOORING TYPES</b> Material: <input type="text" value="VSF"/> Base: <input type="text" value="RB"/>	<b>ROOM ACCESSORIES</b> <input checked="" type="checkbox"/> Coat Hooks <input type="checkbox"/> Ceiling Lift <input checked="" type="checkbox"/> Magnetic Whiteboard <input type="checkbox"/> Mirror <input type="checkbox"/> Infant Change Table <input type="checkbox"/> Privacy Curtain
--	--	--	---	--

- LEGEND:**
- WALL AND CEILING LEGEND:**
- AC Architectural Ceiling
  - ACT Acoustic Ceiling Tile
  - ACT-C Cleanroom
  - ARGB Abuse-Resistant Gypsum Board
  - GB Gypsum Board
  - IRGB Impact-Resistant Gypsum Board
  - KLCT Kitchen Lay-in Ceiling Tile
  - MMRGB Moisture and Mould-Resistant Gypsum Board
  - SACT Security Acoustic Ceiling Tile
- WALL FINISHES LEGEND:**
- EWC Epoxy Wall Coating
  - HPC High Performance Coating
  - PT Paint
- CEILING FINISHES LEGEND:**
- ECC Epoxy Ceiling Coating
  - HPC High Performance Coating
  - PF Prefinished
  - PT Paint
- WALL PROTECTION LEGEND:**
- ESRP Extruded Semi-Rigid PVCu Panel
  - FRL Fibre Reinforced Laminate
  - FRP Fibreglass Reinforced Plastic
  - PVW Protective Vinyl Wallcovering
  - RHIS Rigid High Impact Sheet
  - WSSP Wetwall Solid Surface Panel
  - WVV Wetroom Vinyl Wallcovering
- FLOOR FINISHES LEGEND:**
- CFS Concrete Floor Sealer
  - EFC Epoxy Floor Coating
  - PFC Polyurethane Floor Coating
  - RAF Rubber Athletic Flooring
  - RSF Rubber Sheet Flooring
  - SCF Seamless Cushioned Flooring
  - SDRF Static-Dissipative Rubber Sheet Flooring
  - SDVF Static-Dissipative Vinyl Sheet Flooring
  - VSF Vinyl Sheet Flooring
  - WSVF Wetroom Safety Vinyl Sheet Flooring
- FLOOR BASE LEGEND:**
- FCB Flash Cove Base
  - RB Rubber Base
  - SCF Seamless Cushioned Flooring

**DOORS**

Types:

Type	Qty	Size (mm)	Material	Finish	Side Lt	Blinds	Protect	Privacy Film	Function	Card Reader	Mag Lock	Auto Opener	Hold Open	Hinges	Accessory 1	Accessory 2	Accessory 3	Closer
B	1	915 x 2135	Solid Core	FRL	<input type="checkbox"/>	<input type="checkbox"/>	1 Low	<input type="checkbox"/>	Storeroom	<input checked="" type="checkbox"/>	<input type="checkbox"/>	<input type="checkbox"/>	<input type="checkbox"/>	Butt Hinge				Surface

Door Remarks:  Security Grille  Anti-barricade strategy

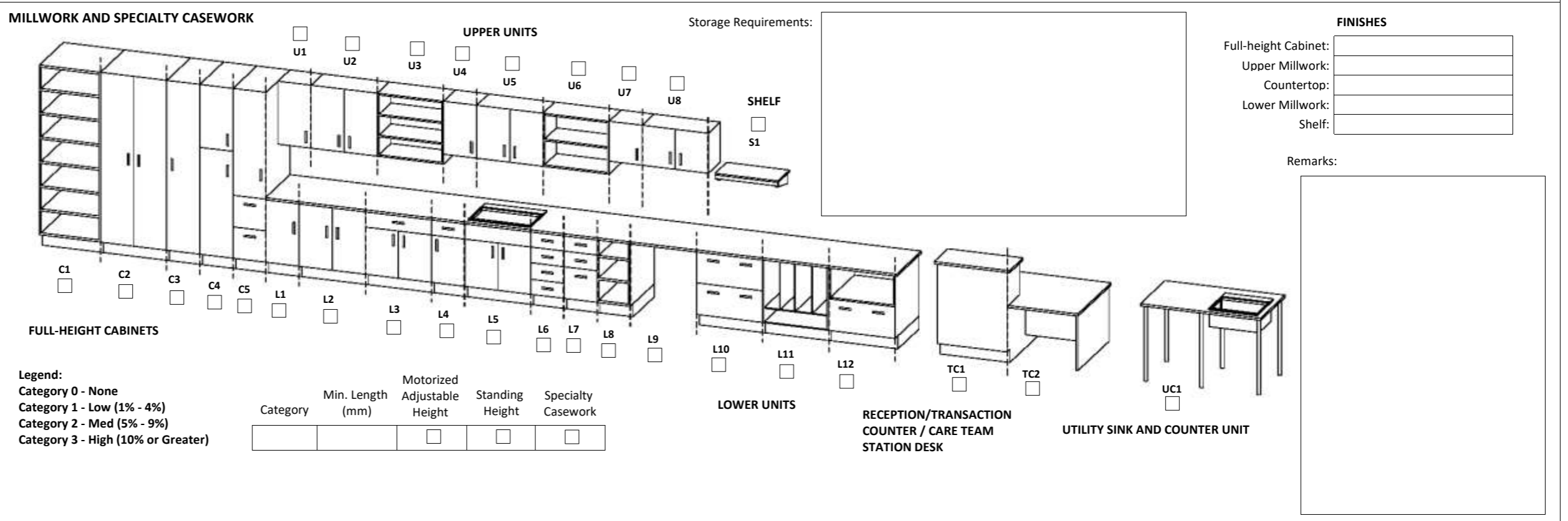

**MECHANICAL REQUIREMENTS**

<b>PLUMBING</b> (Quantity) Hand Hygiene Sink: <input type="text"/> Lavatory: <input type="text"/> Kitchen Sink: <input type="text"/> Seamless Kitchen Sink: <input type="text"/> Utility / Process Sink: <input type="text"/> Scrub Sink: <input type="text"/> Floor Sink: <input type="text"/> Plumbing Remarks: <input type="text"/>	Other Fixtures: <input type="checkbox"/> Shower <input type="checkbox"/> Eyewash Station <input type="checkbox"/> Tub <input type="checkbox"/> Eyewash/Shower Station <input type="checkbox"/> Ice Maker <input type="checkbox"/> Emergency Shower <input type="checkbox"/> Water Closet <input type="checkbox"/> Flush Rim Sink <input type="checkbox"/> Instantaneous Hot Water <input type="checkbox"/> Floor Drain <input type="checkbox"/> <input type="checkbox"/> Water Bottle Refill Station Other: <input type="text"/>	<b>MED / NON-MED GASES</b> (Quantity) Oxygen: <input type="text"/> Medical Air: <input type="text"/> Medical Vacuum: <input type="text"/> Nitrous Oxide: <input type="text"/> CO2: <input type="text"/> AGSS: <input type="text"/> Nitrogen: <input type="text"/> Laboratory Air: <input type="text"/> Laboratory Vacuum: <input type="text"/> Utility Compressed Air: <input type="text"/> Gas Remarks: <input type="text"/>
---	---	---



**Appendix 1B Minimum Room Requirements**

Room Name:

Program Number(s):

1. U5.06	7.	13.	19.	25.	31.	37.	43.
2.	8.	14.	20.	26.	32.	38.	44.
3.	9.	15.	21.	27.	33.	39.	45.
4.	10.	16.	22.	28.	34.	40.	46.
5.	11.	17.	23.	29.	35.	41.	47.
6.	12.	18.	24.	30.	36.	42.	48.

**ARCHITECTURAL REQUIREMENTS**

<b>WALL AND CEILING</b> Wall Material: <input type="text" value="ARGB 1.2m AFF, GB above"/> Finish: <input type="text" value="PT"/> Ceiling Material: <input type="text" value="ACT"/> Finish: <input type="text" value="PF"/>	<b>WALL PROTECTION</b> Type: <input type="text" value="PVW"/> <input checked="" type="checkbox"/> Corner Guards <input type="checkbox"/> Hand Rails <input type="checkbox"/> Bed Bumper / Locator Height: <input type="text" value="1350 mm"/> <input type="checkbox"/> Crash Rails <input checked="" type="checkbox"/> Chair Rail	<b>GLAZING</b> <input checked="" type="checkbox"/> Interior Glazing	<b>FLOORING TYPES</b> Material: <input type="text" value="VSF"/> Base: <input type="text" value="RB"/>	<b>ROOM ACCESSORIES</b> <input checked="" type="checkbox"/> Coat Hooks <input type="checkbox"/> Ceiling Lift <input checked="" type="checkbox"/> Magnetic Whiteboard <input type="checkbox"/> Mirror <input type="checkbox"/> Infant Change Table <input type="checkbox"/> Privacy Curtain
--	--	--	---	--

- LEGEND:**
- WALL AND CEILING LEGEND:**
- AC Architectural Ceiling
  - ACT Acoustic Ceiling Tile
  - ACT-C Cleanroom
  - ARGB Abuse-Resistant Gypsum Board
  - GB Gypsum Board
  - IRGB Impact-Resistant Gypsum Board
  - KLCT Kitchen Lay-in Ceiling Tile
  - MMRGB Moisture and Mould-Resistant Gypsum Board
  - SACT Security Acoustic Ceiling Tile
- WALL FINISHES LEGEND:**
- EWC Epoxy Wall Coating
  - HPC High Performance Coating
  - PT Paint
- CEILING FINISHES LEGEND:**
- ECC Epoxy Ceiling Coating
  - HPC High Performance Coating
  - PF Prefinished
  - PT Paint
- WALL PROTECTION LEGEND:**
- ESRP Extruded Semi-Rigid PVCu Panel
  - FRL Fibre Reinforced Laminate
  - FRP Fibreglass Reinforced Plastic
  - PVW Protective Vinyl Wallcovering
  - RHIS Rigid High Impact Sheet
  - WSSP Wetwall Solid Surface Panel
  - WVV Wetroom Vinyl Wallcovering
- FLOOR FINISHES LEGEND:**
- CFS Concrete Floor Sealer
  - EFC Epoxy Floor Coating
  - PFC Polyurethane Floor Coating
  - RAF Rubber Athletic Flooring
  - RSF Rubber Sheet Flooring
  - SCF Seamless Cushioned Flooring
  - SDRF Static-Dissipative Rubber Sheet Flooring
  - SDVF Static-Dissipative Vinyl Sheet Flooring
  - VSF Vinyl Sheet Flooring
  - WSVF Wetroom Safety Vinyl Sheet Flooring
- FLOOR BASE LEGEND:**
- FCB Flash Cove Base
  - RB Rubber Base
  - SCF Seamless Cushioned Flooring

**DOORS**

Types:

Type	Qty	Size (mm)	Material	Finish	Side Lt.	Blinds	Protect.	Film	Function	Card Reader	Mag Lock	Auto Opener	Hold Open	Hinges	Accessory 1	Accessory 2	Accessory 3	Closer
B	1	915 x 2135	Solid Core	FRL	<input type="checkbox"/>	<input type="checkbox"/>	1 Low	<input type="checkbox"/>	Storeroom	<input checked="" type="checkbox"/>	<input type="checkbox"/>	<input type="checkbox"/>	<input type="checkbox"/>	Butt Hinge				Surface

Door Remarks:  Security Grille  Anti-barricade strategy

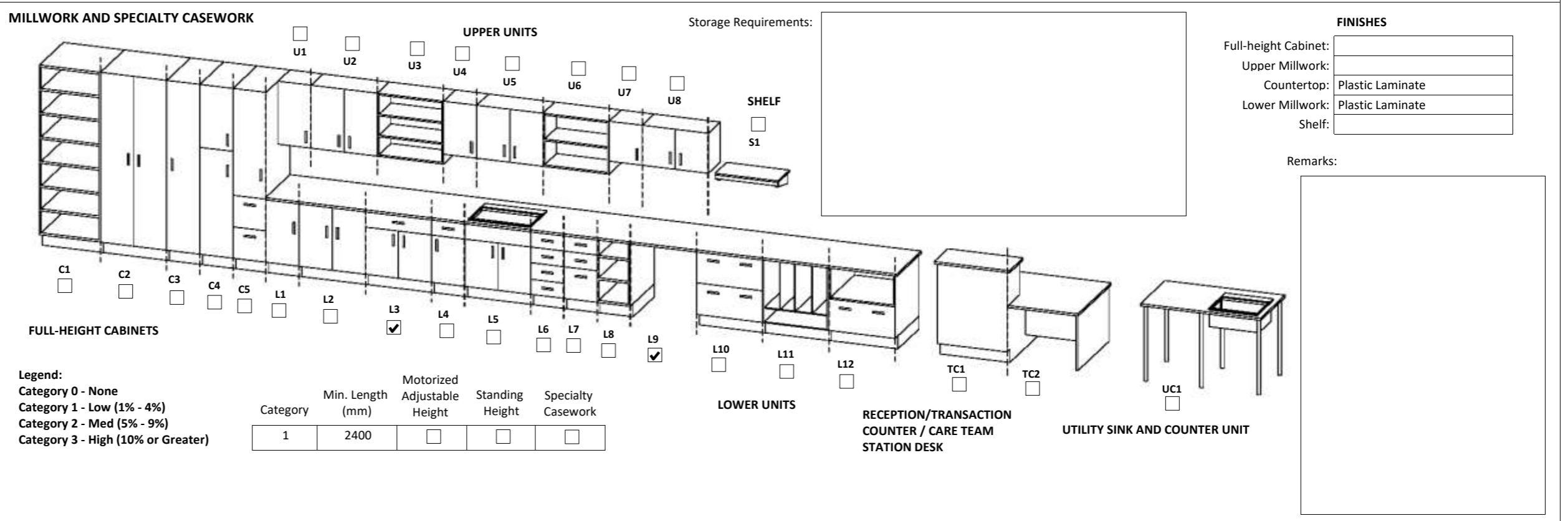

**MECHANICAL REQUIREMENTS**

<b>PLUMBING</b> (Quantity) Hand Hygiene Sink: <input type="text"/> Lavatory: <input type="text"/> Kitchen Sink: <input type="text"/> Seamless Kitchen Sink: <input type="text"/> Utility / Process Sink: <input type="text"/> Scrub Sink: <input type="text"/> Floor Sink: <input type="text"/> Plumbing Remarks: <input type="text"/>	Other Fixtures: <input type="checkbox"/> Shower <input type="checkbox"/> Eyewash Station <input type="checkbox"/> Tub <input type="checkbox"/> Eyewash/Shower Station <input type="checkbox"/> Ice Maker <input type="checkbox"/> Emergency Shower <input type="checkbox"/> Water Closet <input type="checkbox"/> Flush Rim Sink <input type="checkbox"/> Instantaneous Hot Water <input type="checkbox"/> Floor Drain <input type="checkbox"/> <input type="checkbox"/> Water Bottle Refill Station Other: <input type="text"/>	<b>MED / NON-MED GASES</b> (Quantity) Oxygen: <input type="text"/> Medical Air: <input type="text"/> Medical Vacuum: <input type="text"/> Nitrous Oxide: <input type="text"/> CO2: <input type="text"/> AGSS: <input type="text"/> Nitrogen: <input type="text"/> Laboratory Air: <input type="text"/> Laboratory Vacuum: <input type="text"/> Utility Compressed Air: <input type="text"/> Gas Remarks: <input type="text"/>
---	---	--

# Appendix 1B Minimum Room Requirements

Room Name:

Program Number(s):

1.	H1.02	7.		13.		19.		25.		31.		37.		43.
2.		8.		14.		20.		26.		32.		38.		44.
3.		9.		15.		21.		27.		33.		39.		45.
4.		10.		16.		22.		28.		34.		40.		46.
5.		11.		17.		23.		29.		35.		41.		47.
6.		12.		18.		24.		30.		36.		42.		48.

## ARCHITECTURAL REQUIREMENTS

<b>WALL AND CEILING</b> Wall Material: <input type="text" value="ARGB 1.2m AFF, GB above"/> Finish: <input type="text" value="PT"/> Ceiling Material: <input type="text" value="ACT"/> Finish: <input type="text" value="PF"/>		<b>WALL PROTECTION</b> Type: <input type="text" value="PVW"/> <input checked="" type="checkbox"/> Corner Guards <input type="checkbox"/> Hand Rails <input type="checkbox"/> Bed Bumper / Locator Height: <input type="text" value="1350 mm"/> <input type="checkbox"/> Crash Rails <input checked="" type="checkbox"/> Chair Rail			<b>GLAZING</b> <input checked="" type="checkbox"/> Interior Glazing		<b>FLOORING TYPES</b> Material: <input type="text" value="VSF"/> Base: <input type="text" value="RB"/>		<b>ROOM ACCESSORIES</b> <input checked="" type="checkbox"/> Coat Hooks <input type="checkbox"/> Ceiling Lift <input checked="" type="checkbox"/> Magnetic Whiteboard <input type="checkbox"/> Mirror <input type="checkbox"/> Infant Change Table <input type="checkbox"/> Privacy Curtain		
--	--	--	--	--	--	--	---	--	--	--	--

- LEGEND:**
- WALL AND CEILING LEGEND:**
- AC Architectural Ceiling
  - ACT Acoustic Ceiling Tile
  - ACT-C Cleanroom
  - ARGB Abuse-Resistant Gypsum Board
  - GB Gypsum Board
  - IRGB Impact-Resistant Gypsum Board
  - KLCT Kitchen Lay-in Ceiling Tile
  - MMRGB Moisture and Mould-Resistant Gypsum Board
  - SACT Security Acoustic Ceiling Tile
- WALL FINISHES LEGEND:**
- EWC Epoxy Wall Coating
  - HPC High Performance Coating
  - PT Paint
- CEILING FINISHES LEGEND:**
- ECC Epoxy Ceiling Coating
  - HPC High Performance Coating
  - PF Prefinished
  - PT Paint
- WALL PROTECTION LEGEND:**
- ESRP Extruded Semi-Rigid PVCu Panel
  - FRL Fibre Reinforced Laminate
  - FRP Fibreglass Reinforced Plastic
  - PVW Protective Vinyl Wallcovering
  - RHIS Rigid High Impact Sheet
  - WSSP Wetwall Solid Surface Panel
  - WVV Wetroom Vinyl Wallcovering
- FLOOR FINISHES LEGEND:**
- CFS Concrete Floor Sealer
  - EFC Epoxy Floor Coating
  - PFC Polyurethane Floor Coating
  - RAF Rubber Athletic Flooring
  - RSF Rubber Sheet Flooring
  - SCF Seamless Cushioned Flooring
  - SDRF Static-Dissipative Rubber Sheet Flooring
  - SDVF Static-Dissipative Vinyl Sheet Flooring
  - VSF Vinyl Sheet Flooring
  - WSVF Wetroom Safety Vinyl Sheet Flooring
- FLOOR BASE LEGEND:**
- FCB Flash Cove Base
  - RB Rubber Base
  - SCF Seamless Cushioned Flooring

**DOORS**

Types:

Type	Qty	Size (mm)	Material	Finish	Side Lt.	Blinds	Protect.	Privacy Film	Function	Card Reader	Mag Lock	Auto Opener	Hold Open	Hinges	Accessory 1	Accessory 2	Accessory 3	Closer
B	1	915 x 2135	Solid Core	FRL			2 High		Storeroom	<input checked="" type="checkbox"/>				Butt Hinge				Surface

Door Remarks:  Security Grille  Anti-barricade strategy

**MILLWORK AND SPECIALTY CASEWORK**

**UPPER UNITS** (U1-U8) **LOWER UNITS** (L1-L12) **RECEPTION/TRANSACTION COUNTER / CARE TEAM STATION DESK** (TC1-TC2) **UTILITY SINK AND COUNTER UNIT** (UC1)

Storage Requirements:

**FINISHES**

Full-height Cabinet:   
 Upper Millwork:   
 Countertop:   
 Lower Millwork:   
 Shelf:

Remarks:

**Legend:**

Category	Min. Length (mm)	Motorized Adjustable Height	Standing Height	Specialty Casework
Category 0 - None				
Category 1 - Low (1% - 4%)				
Category 2 - Med (5% - 9%)				
Category 3 - High (10% or Greater)				

## MECHANICAL REQUIREMENTS

<b>PLUMBING</b> (Quantity) Hand Hygiene Sink: <input type="text"/> Lavatory: <input type="text"/> Kitchen Sink: <input type="text"/> Seamless Kitchen Sink: <input type="text"/> Utility / Process Sink: <input type="text"/> Scrub Sink: <input type="text"/> Floor Sink: <input type="text"/>							Other Fixtures: <input type="checkbox"/> Shower <input type="checkbox"/> Tub <input type="checkbox"/> Ice Maker <input type="checkbox"/> Water Closet <input type="checkbox"/> Instantaneous Hot Water <input type="checkbox"/> Eyewash Station <input type="checkbox"/> Eyewash/Shower Station <input type="checkbox"/> Emergency Shower <input type="checkbox"/> Flush Rim Sink <input type="checkbox"/> Floor Drain <input type="checkbox"/> Water Bottle Refill Station Other: <input type="text"/>				<b>MED / NON-MED GASES</b> (Quantity) Oxygen: <input type="text"/> Medical Air: <input type="text"/> Medical Vacuum: <input type="text"/> Nitrous Oxide: <input type="text"/> CO2: <input type="text"/> AGSS: <input type="text"/> Nitrogen: <input type="text"/> Laboratory Air: <input type="text"/> Laboratory Vacuum: <input type="text"/> Utility Compressed Air: <input type="text"/>				
Plumbing Remarks: <input type="text"/>							Gas Remarks: <input type="text"/>								

# Appendix 1B Minimum Room Requirements

Room Name:

Program Number(s):	1. H1.03	7.	13.	19.	25.	31.	37.	43.
	2.	8.	14.	20.	26.	32.	38.	44.
	3.	9.	15.	21.	27.	33.	39.	45.
	4.	10.	16.	22.	28.	34.	40.	46.
	5.	11.	17.	23.	29.	35.	41.	47.
	6.	12.	18.	24.	30.	36.	42.	48.

## ARCHITECTURAL REQUIREMENTS

<b>WALL AND CEILING</b> Wall Material: <input type="text" value="ARGB 1.2m AFF, GB above"/> Finish: <input type="text" value="PT"/> Ceiling Material: <input type="text" value="ACT"/> Finish: <input type="text" value="PF"/>	<b>WALL PROTECTION</b> Type: <input type="text" value="PVW"/> <input checked="" type="checkbox"/> Corner Guards <input type="checkbox"/> Hand Rails <input type="checkbox"/> Bed Bumper / Locator Height: <input type="text" value="1350 mm"/> <input type="checkbox"/> Crash Rails <input checked="" type="checkbox"/> Chair Rail	<b>GLAZING</b> <input checked="" type="checkbox"/> Interior Glazing	<b>FLOORING TYPES</b> Material: <input type="text" value="VSF"/> Base: <input type="text" value="RB"/>	<b>ROOM ACCESSORIES</b> <input checked="" type="checkbox"/> Coat Hooks <input type="checkbox"/> Ceiling Lift <input checked="" type="checkbox"/> Magnetic Whiteboard <input type="checkbox"/> Mirror <input type="checkbox"/> Infant Change Table <input type="checkbox"/> Privacy Curtain
--	--	--	---	--

- LEGEND:**
- WALL AND CEILING LEGEND:**
- AC Architectural Ceiling
  - ACT Acoustic Ceiling Tile
  - ACT-C Cleanroom
  - ARGB Abuse-Resistant Gypsum Board
  - GB Gypsum Board
  - IRGB Impact-Resistant Gypsum Board
  - KLCT Kitchen Lay-in Ceiling Tile
  - MMRGB Moisture and Mould-Resistant Gypsum Board
  - SACT Security Acoustic Ceiling Tile
- WALL FINISHES LEGEND:**
- EWC Epoxy Wall Coating
  - HPC High Performance Coating
  - PT Paint
- CEILING FINISHES LEGEND:**
- ECC Epoxy Ceiling Coating
  - HPC High Performance Coating
  - PF Prefinished
  - PT Paint
- WALL PROTECTION LEGEND:**
- ESRP Extruded Semi-Rigid PVCu Panel
  - FRL Fibre Reinforced Laminate
  - FRP Fibreglass Reinforced Plastic
  - PVW Protective Vinyl Wallcovering
  - RHIS Rigid High Impact Sheet
  - WSSP Wetwall Solid Surface Panel
  - WVV Wetroom Vinyl Wallcovering
- FLOOR FINISHES LEGEND:**
- CFS Concrete Floor Sealer
  - EFC Epoxy Floor Coating
  - PFC Polyurethane Floor Coating
  - RAF Rubber Athletic Flooring
  - RSF Rubber Sheet Flooring
  - SCF Seamless Cushioned Flooring
  - SDRF Static-Dissipative Rubber Sheet Flooring
  - SDVF Static-Dissipative Vinyl Sheet Flooring
  - VSF Vinyl Sheet Flooring
  - WSVF Wetroom Safety Vinyl Sheet Flooring
- FLOOR BASE LEGEND:**
- FCB Flash Cove Base
  - RB Rubber Base
  - SCF Seamless Cushioned Flooring

**DOORS**

Types:

Type	Qty	Size (mm)	Material	Finish	Side Lt.	Blinds	Protect.	Privacy Film	Function	Card Reader	Mag Lock	Auto Opener	Hold Open	Hinges	Accessory 1	Accessory 2	Accessory 3	Closer
B	1	915 x 2135	Solid Core	FRL	<input type="checkbox"/>	<input type="checkbox"/>	2 High	<input type="checkbox"/>	Storeroom	<input checked="" type="checkbox"/>	<input type="checkbox"/>	<input type="checkbox"/>	<input type="checkbox"/>	Butt Hinge				Surface

Door Remarks:  Security Grille  Anti-barricade strategy

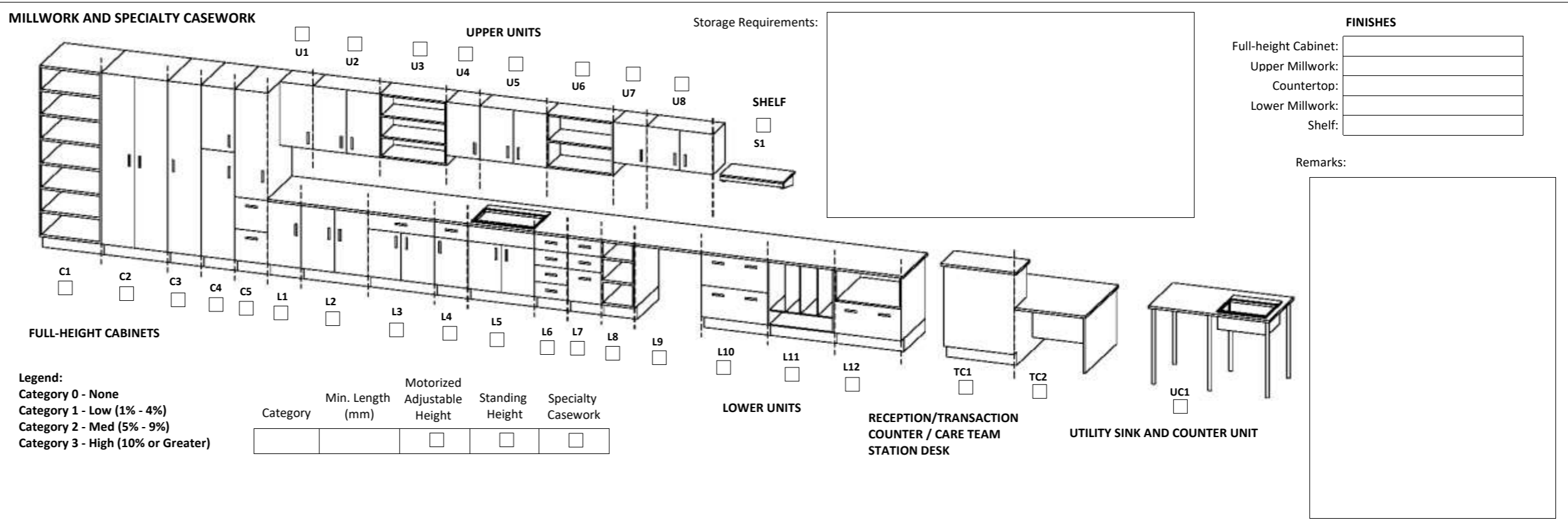

## MECHANICAL REQUIREMENTS

<p><b>PLUMBING</b> (Quantity)</p> <table border="1"> <tr> <td>Hand Hygiene Sink:</td> <td>Lavatory:</td> <td>Kitchen Sink:</td> <td>Seamless Kitchen Sink:</td> <td>Utility / Process Sink:</td> <td>Scrub Sink:</td> <td>Floor Sink:</td> </tr> <tr> <td><input type="text"/></td> <td><input type="text"/></td> <td><input type="text"/></td> <td><input type="text"/></td> <td><input type="text"/></td> <td><input type="text"/></td> <td><input type="text"/></td> </tr> </table> <p>Plumbing Remarks: <input type="text"/></p>	Hand Hygiene Sink:	Lavatory:	Kitchen Sink:	Seamless Kitchen Sink:	Utility / Process Sink:	Scrub Sink:	Floor Sink:	<input type="text"/>	<input type="text"/>	<input type="text"/>	<input type="text"/>	<input type="text"/>	<input type="text"/>	<input type="text"/>	<p><b>Other Fixtures:</b></p> <table border="1"> <tr> <td><input type="checkbox"/> Shower</td> <td><input type="checkbox"/> Eyewash Station</td> </tr> <tr> <td><input type="checkbox"/> Tub</td> <td><input type="checkbox"/> Eyewash/Shower Station</td> </tr> <tr> <td><input type="checkbox"/> Ice Maker</td> <td><input type="checkbox"/> Emergency Shower</td> </tr> <tr> <td><input type="checkbox"/> Water Closet</td> <td><input type="checkbox"/> Flush Rim Sink</td> </tr> <tr> <td><input type="checkbox"/> Instantaneous Hot Water</td> <td><input type="checkbox"/> Floor Drain</td> </tr> <tr> <td></td> <td><input type="checkbox"/> Water Bottle Refill Station</td> </tr> </table> <p>Other: <input type="text"/></p>	<input type="checkbox"/> Shower	<input type="checkbox"/> Eyewash Station	<input type="checkbox"/> Tub	<input type="checkbox"/> Eyewash/Shower Station	<input type="checkbox"/> Ice Maker	<input type="checkbox"/> Emergency Shower	<input type="checkbox"/> Water Closet	<input type="checkbox"/> Flush Rim Sink	<input type="checkbox"/> Instantaneous Hot Water	<input type="checkbox"/> Floor Drain		<input type="checkbox"/> Water Bottle Refill Station	<p><b>MED / NON-MED GASES</b> (Quantity)</p> <table border="1"> <tr> <td>Oxygen:</td> <td>Medical Air:</td> <td>Medical Vacuum:</td> <td>Nitrous Oxide:</td> <td>CO2:</td> <td>AGSS:</td> <td>Nitrogen:</td> <td>Laboratory Air:</td> <td>Laboratory Vacuum:</td> <td>Utility Compressed Air:</td> </tr> <tr> <td><input type="text"/></td> <td><input type="text"/></td> <td><input type="text"/></td> <td><input type="text"/></td> <td><input type="text"/></td> <td><input type="text"/></td> <td><input type="text"/></td> <td><input type="text"/></td> <td><input type="text"/></td> <td><input type="text"/></td> </tr> </table> <p>Gas Remarks: <input type="text"/></p>	Oxygen:	Medical Air:	Medical Vacuum:	Nitrous Oxide:	CO2:	AGSS:	Nitrogen:	Laboratory Air:	Laboratory Vacuum:	Utility Compressed Air:	<input type="text"/>	<input type="text"/>	<input type="text"/>	<input type="text"/>	<input type="text"/>	<input type="text"/>	<input type="text"/>	<input type="text"/>	<input type="text"/>	<input type="text"/>
Hand Hygiene Sink:	Lavatory:	Kitchen Sink:	Seamless Kitchen Sink:	Utility / Process Sink:	Scrub Sink:	Floor Sink:																																										
<input type="text"/>	<input type="text"/>	<input type="text"/>	<input type="text"/>	<input type="text"/>	<input type="text"/>	<input type="text"/>																																										
<input type="checkbox"/> Shower	<input type="checkbox"/> Eyewash Station																																															
<input type="checkbox"/> Tub	<input type="checkbox"/> Eyewash/Shower Station																																															
<input type="checkbox"/> Ice Maker	<input type="checkbox"/> Emergency Shower																																															
<input type="checkbox"/> Water Closet	<input type="checkbox"/> Flush Rim Sink																																															
<input type="checkbox"/> Instantaneous Hot Water	<input type="checkbox"/> Floor Drain																																															
	<input type="checkbox"/> Water Bottle Refill Station																																															
Oxygen:	Medical Air:	Medical Vacuum:	Nitrous Oxide:	CO2:	AGSS:	Nitrogen:	Laboratory Air:	Laboratory Vacuum:	Utility Compressed Air:																																							
<input type="text"/>	<input type="text"/>	<input type="text"/>	<input type="text"/>	<input type="text"/>	<input type="text"/>	<input type="text"/>	<input type="text"/>	<input type="text"/>	<input type="text"/>																																							



**Appendix 1B Minimum Room Requirements**

Room Name:

Program Number(s):

1.	X4.03	7.		13.		19.		25.		31.		37.		43.
2.		8.		14.		20.		26.		32.		38.		44.
3.		9.		15.		21.		27.		33.		39.		45.
4.		10.		16.		22.		28.		34.		40.		46.
5.		11.		17.		23.		29.		35.		41.		47.
6.		12.		18.		24.		30.		36.		42.		48.

**ARCHITECTURAL REQUIREMENTS**

<b>WALL AND CEILING</b> Wall Material: <input type="text" value="ARGB 1.2m AFF, GB above"/> Finish: <input type="text" value="HPC"/> Ceiling Material: <input type="text" value="KLCT"/> Finish: <input type="text" value="PF"/>		<b>WALL PROTECTION</b> Type: <input type="text" value="FRP"/> <input checked="" type="checkbox"/> Corner Guards <input type="checkbox"/> Hand Rails <input type="checkbox"/> Bed Bumper / Locator Height: <input type="text" value="2185 mm"/> <input type="checkbox"/> Crash Rails <input checked="" type="checkbox"/> Chair Rail		<b>GLAZING</b> <input checked="" type="checkbox"/> Interior Glazing		<b>FLOORING TYPES</b> Material: <input type="text" value="PFC"/> Base: <input type="text" value="RB"/>		<b>ROOM ACCESSORIES</b> <input checked="" type="checkbox"/> Coat Hooks <input type="checkbox"/> Ceiling Lift <input checked="" type="checkbox"/> Magnetic Whiteboard <input type="checkbox"/> Mirror <input type="checkbox"/> Infant Change Table <input type="checkbox"/> Privacy Curtain	
--	--	--	--	--	--	---	--	--	--

- LEGEND:**
- WALL AND CEILING LEGEND:**
- AC Architectural Ceiling
  - ACT Acoustic Ceiling Tile
  - ACT-C Cleanroom
  - ARGB Abuse-Resistant Gypsum Board
  - GB Gypsum Board
  - IRGB Impact-Resistant Gypsum Board
  - KLCT Kitchen Lay-in Ceiling Tile
  - MMRGB Moisture and Mould-Resistant Gypsum Board
  - SACT Security Acoustic Ceiling Tile
- WALL FINISHES LEGEND:**
- EWC Epoxy Wall Coating
  - HPC High Performance Coating
  - PT Paint
- CEILING FINISHES LEGEND:**
- ECC Epoxy Ceiling Coating
  - HPC High Performance Coating
  - PF Prefinished
  - PT Paint
- WALL PROTECTION LEGEND:**
- ESRP Extruded Semi-Rigid PVCu Panel
  - FRL Fibre Reinforced Laminate
  - FRP Fibreglass Reinforced Plastic
  - PVV Protective Vinyl Wallcovering
  - RHIS Rigid High Impact Sheet
  - WSSP Wetwall Solid Surface Panel
  - WVV Wetroom Vinyl Wallcovering
- FLOOR FINISHES LEGEND:**
- CFS Concrete Floor Sealer
  - EFC Epoxy Floor Coating
  - PFC Polyurethane Floor Coating
  - RAF Rubber Athletic Flooring
  - RSF Rubber Sheet Flooring
  - SCF Seamless Cushioned Flooring
  - SDRF Static-Dissipative Rubber Sheet Flooring
  - SDVF Static-Dissipative Vinyl Sheet Flooring
  - VSF Vinyl Sheet Flooring
  - WSVF Wetroom Safety Vinyl Sheet Flooring
- FLOOR BASE LEGEND:**
- FCB Flash Cove Base
  - RB Rubber Base
  - SCF Seamless Cushioned Flooring

**DOORS**

Types:

Type	Qty	Size (mm)	Material	Finish	Side Lt.	Blinds	Protect.	Privacy Film	Function	Card Reader	Mag Lock	Auto Opener	Hold Open	Hinges	Accessory 1	Accessory 2	Accessory 3	Closer
B	1	915 x 2135	Solid Core	FRL			2 High		Passage				<input checked="" type="checkbox"/>	Butt Hinge				Surface

Door Remarks:  Security Grille  Anti-barricade strategy

**MILLWORK AND SPECIALTY CASEWORK**

Storage Requirements: Refer to Schedule 1 for Digital Device Locker requirements.

**UPPER UNITS** (U1-U8)

**LOWER UNITS** (L1-L12)

**RECEPTION/TRANSACTION COUNTER / CARE TEAM STATION DESK** (TC1, TC2)

**UTILITY SINK AND COUNTER UNIT** (UC1)

**FINISHES**

Full-height Cabinet:	Plastic Laminate
Upper Millwork:	Plastic Laminate
Countertop:	Solid Surfacing
Lower Millwork:	Plastic Laminate
Shelf:	

Remarks: Work surfaces to support both standing height and seating height

**Legend:**

Category	Min. Length (mm)	Motorized Adjustable Height	Standing Height	Specialty Casework
3	4500	<input type="checkbox"/>	<input checked="" type="checkbox"/>	<input type="checkbox"/>

**MECHANICAL REQUIREMENTS**

<b>PLUMBING</b> (Quantity) Hand Hygiene Sink: <input type="text"/> Lavatory: <input type="text"/> Kitchen Sink: <input type="text"/> Seamless Kitchen Sink: <input type="text"/> Utility / Process Sink: <input type="text"/> Scrub Sink: <input type="text"/> Floor Sink: <input type="text"/>							Other Fixtures: <input type="checkbox"/> Shower <input type="checkbox"/> Tub <input type="checkbox"/> Ice Maker <input type="checkbox"/> Water Closet <input type="checkbox"/> Instantaneous Hot Water				<input type="checkbox"/> Eyewash Station <input type="checkbox"/> Eyewash/Shower Station <input type="checkbox"/> Emergency Shower <input type="checkbox"/> Flush Rim Sink <input type="checkbox"/> Floor Drain <input type="checkbox"/> Water Bottle Refill Station				<b>MED / NON-MED GASES</b> (Quantity) Oxygen: <input type="text"/> Medical Air: <input type="text"/> Medical Vacuum: <input type="text"/> Nitrous Oxide: <input type="text"/> CO2: <input type="text"/> AGSS: <input type="text"/> Nitrogen: <input type="text"/> Laboratory Air: <input type="text"/> Laboratory Vacuum: <input type="text"/> Utility Compressed Air: <input type="text"/>			
Plumbing Remarks: <input type="text"/>							Gas Remarks: <input type="text"/>											

**Appendix 1B Minimum Room Requirements**

Room Name:

Program Number(s):

1. K2.01	7.	13.	19.	25.	31.	37.	43.
2.	8.	14.	20.	26.	32.	38.	44.
3.	9.	15.	21.	27.	33.	39.	45.
4.	10.	16.	22.	28.	34.	40.	46.
5.	11.	17.	23.	29.	35.	41.	47.
6.	12.	18.	24.	30.	36.	42.	48.

**ARCHITECTURAL REQUIREMENTS**

<b>WALL AND CEILING</b> Wall Material: <input type="text" value="ARGB 1.2m AFF, GB above"/> Finish: <input type="text" value="PT"/> Ceiling Material: <input type="text" value="ACT"/> Finish: <input type="text" value="PF"/>	<b>WALL PROTECTION</b> Type: <input type="text" value="RHIS"/> <input checked="" type="checkbox"/> Corner Guards <input type="checkbox"/> Hand Rails <input type="checkbox"/> Bed Bumper / Locator Height: <input type="text" value="1350 mm"/> <input type="checkbox"/> Crash Rails <input checked="" type="checkbox"/> Chair Rail	<b>GLAZING</b> <input checked="" type="checkbox"/> Interior Glazing	<b>FLOORING TYPES</b> Material: <input type="text" value="VSF"/> Base: <input type="text" value="RB"/>	<b>ROOM ACCESSORIES</b> <input checked="" type="checkbox"/> Coat Hooks <input type="checkbox"/> Ceiling Lift <input checked="" type="checkbox"/> Magnetic Whiteboard <input type="checkbox"/> Mirror <input type="checkbox"/> Infant Change Table <input type="checkbox"/> Privacy Curtain
--	---	--	---	--

- LEGEND:**
- WALL AND CEILING LEGEND:**
- AC Architectural Ceiling
  - ACT Acoustic Ceiling Tile
  - ACT-C Cleanroom
  - ARGB Abuse-Resistant Gypsum Board
  - GB Gypsum Board
  - IRGB Impact-Resistant Gypsum Board
  - KLCT Kitchen Lay-in Ceiling Tile
  - MMRGB Moisture and Mould-Resistant Gypsum Board
  - SACT Security Acoustic Ceiling Tile
- WALL FINISHES LEGEND:**
- EWC Epoxy Wall Coating
  - HPC High Performance Coating
  - PT Paint
- CEILING FINISHES LEGEND:**
- ECC Epoxy Ceiling Coating
  - HPC High Performance Coating
  - PF Prefinished
  - PT Paint
- WALL PROTECTION LEGEND:**
- ESRP Extruded Semi-Rigid PVCu Panel
  - FRL Fibre Reinforced Laminate
  - FRP Fibreglass Reinforced Plastic
  - PVV Protective Vinyl Wallcovering
  - RHIS Rigid High Impact Sheet
  - WSSP Wetwall Solid Surface Panel
  - WVV Wetroom Vinyl Wallcovering
- FLOOR FINISHES LEGEND:**
- CFS Concrete Floor Sealer
  - EFC Epoxy Floor Coating
  - PFC Polyurethane Floor Coating
  - RAF Rubber Athletic Flooring
  - RSF Rubber Sheet Flooring
  - SCF Seamless Cushioned Flooring
  - SDRF Static-Dissipative Rubber Sheet Flooring
  - SDVF Static-Dissipative Vinyl Sheet Flooring
  - VSF Vinyl Sheet Flooring
  - WSVF Wetroom Safety Vinyl Sheet Flooring
- FLOOR BASE LEGEND:**
- FCB Flash Cove Base
  - RB Rubber Base
  - SCF Seamless Cushioned Flooring

**DOORS**

Types:

Type	Qty	Size (mm)	Material	Finish	Side Lt.	Blinds	Protect.	Privacy Film	Function	Card Reader	Mag Lock	Auto Opener	Hold Open	Hinges	Accessory 1	Accessory 2	Accessory 3	Closer
B	1	1830 x 2440	Solid Core	FRL	<input type="checkbox"/>	<input type="checkbox"/>	2 High	<input type="checkbox"/>	Storeroom	<input checked="" type="checkbox"/>	<input type="checkbox"/>	<input type="checkbox"/>	<input type="checkbox"/>	Butt Hinge				Surface

Door Remarks:  Security Grille  Anti-barricade strategy

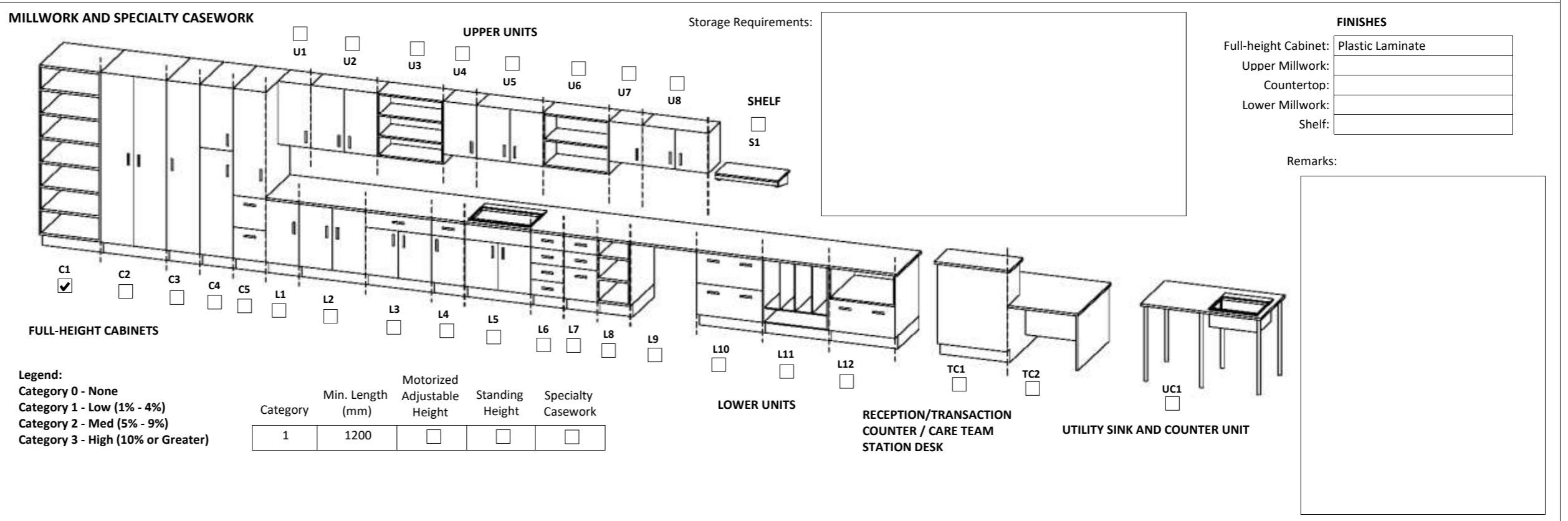

**MECHANICAL REQUIREMENTS**

<b>PLUMBING</b> (Quantity) Hand Hygiene Sink: <input type="text"/> Lavatory: <input type="text"/> Kitchen Sink: <input type="text"/> Seamless Kitchen Sink: <input type="text"/> Utility / Process Sink: <input type="text"/> Scrub Sink: <input type="text"/> Floor Sink: <input type="text"/> Plumbing Remarks: <input type="text"/>	Other Fixtures: <input type="checkbox"/> Shower <input type="checkbox"/> Eyewash Station <input type="checkbox"/> Tub <input type="checkbox"/> Eyewash/Shower Station <input type="checkbox"/> Ice Maker <input type="checkbox"/> Emergency Shower <input type="checkbox"/> Water Closet <input type="checkbox"/> Flush Rim Sink <input type="checkbox"/> Instantaneous Hot Water <input type="checkbox"/> Floor Drain <input type="checkbox"/> <input type="checkbox"/> Water Bottle Refill Station Other <input type="text"/>	<b>MED / NON-MED GASES</b> (Quantity) Oxygen: <input type="text"/> Medical Air: <input type="text"/> Medical Vacuum: <input type="text"/> Nitrous Oxide: <input type="text"/> CO2: <input type="text"/> AGSS: <input type="text"/> Nitrogen: <input type="text"/> Laboratory Air: <input type="text"/> Laboratory Vacuum: <input type="text"/> Utility Compressed Air: <input type="text"/> Gas Remarks: <input type="text"/>
---	--	---

**Appendix 1B Minimum Room Requirements**

Room Name:

Program Number(s):

1. U5.01	7.	13.	19.	25.	31.	37.	43.
2.	8.	14.	20.	26.	32.	38.	44.
3.	9.	15.	21.	27.	33.	39.	45.
4.	10.	16.	22.	28.	34.	40.	46.
5.	11.	17.	23.	29.	35.	41.	47.
6.	12.	18.	24.	30.	36.	42.	48.

**ARCHITECTURAL REQUIREMENTS**

<b>WALL AND CEILING</b> Wall Material: <input type="text" value="ARGB 1.2m AFF, GB above"/> Finish: <input type="text" value="PT"/> Ceiling Material: <input type="text" value="ACT"/> Finish: <input type="text" value="PF"/>	<b>WALL PROTECTION</b> Type: <input type="text" value="PVW"/> <input checked="" type="checkbox"/> Corner Guards <input type="checkbox"/> Hand Rails <input type="checkbox"/> Bed Bumper / Locator Height: <input type="text" value="1350 mm"/> <input type="checkbox"/> Crash Rails <input checked="" type="checkbox"/> Chair Rail	<b>GLAZING</b> <input checked="" type="checkbox"/> Interior Glazing	<b>FLOORING TYPES</b> Material: <input type="text" value="VSF"/> Base: <input type="text" value="RB"/>	<b>ROOM ACCESSORIES</b> <input checked="" type="checkbox"/> Coat Hooks <input type="checkbox"/> Ceiling Lift <input checked="" type="checkbox"/> Magnetic Whiteboard <input type="checkbox"/> Mirror <input type="checkbox"/> Infant Change Table <input type="checkbox"/> Privacy Curtain
--	--	--	---	--

- LEGEND:**
- WALL AND CEILING LEGEND:**
- AC Architectural Ceiling
  - ACT Acoustic Ceiling Tile
  - ACT-C Cleanroom
  - ARGB Abuse-Resistant Gypsum Board
  - GB Gypsum Board
  - IRGB Impact-Resistant Gypsum Board
  - KLCT Kitchen Lay-in Ceiling Tile
  - MMRGB Moisture and Mould-Resistant Gypsum Board
  - SACT Security Acoustic Ceiling Tile
- WALL FINISHES LEGEND:**
- EWC Epoxy Wall Coating
  - HPC High Performance Coating
  - PT Paint
- CEILING FINISHES LEGEND:**
- ECC Epoxy Ceiling Coating
  - HPC High Performance Coating
  - PF Prefinished
  - PT Paint
- WALL PROTECTION LEGEND:**
- ESRP Extruded Semi-Rigid PVCu Panel
  - FRL Fibre Reinforced Laminate
  - FRP Fibreglass Reinforced Plastic
  - PVW Protective Vinyl Wallcovering
  - RHIS Rigid High Impact Sheet
  - WSSP Wetwall Solid Surface Panel
  - WVV Wetroom Vinyl Wallcovering
- FLOOR FINISHES LEGEND:**
- CFS Concrete Floor Sealer
  - EFC Epoxy Floor Coating
  - PFC Polyurethane Floor Coating
  - RAF Rubber Athletic Flooring
  - RSF Rubber Sheet Flooring
  - SCF Seamless Cushioned Flooring
  - SDRF Static-Dissipative Rubber Sheet Flooring
  - SDVF Static-Dissipative Vinyl Sheet Flooring
  - VSF Vinyl Sheet Flooring
  - WSVF Wetroom Safety Vinyl Sheet Flooring
- FLOOR BASE LEGEND:**
- FCB Flash Cove Base
  - RB Rubber Base
  - SCF Seamless Cushioned Flooring

**DOORS**

Types:

Type	Qty	Size (mm)	Material	Finish	Side Lt.	Blinds	Protect.	Privacy Film	Function	Card Reader	Mag Lock	Auto Opener	Hold Open	Hinges	Accessory 1	Accessory 2	Accessory 3	Closer
B	1	915 x 2135	Solid Core	FRL	<input type="checkbox"/>	<input type="checkbox"/>	2 High	<input type="checkbox"/>	Storeroom	<input checked="" type="checkbox"/>	<input type="checkbox"/>	<input type="checkbox"/>	<input type="checkbox"/>	Butt Hinge				Surface

Door Remarks:  Security Grille  Anti-barricade strategy

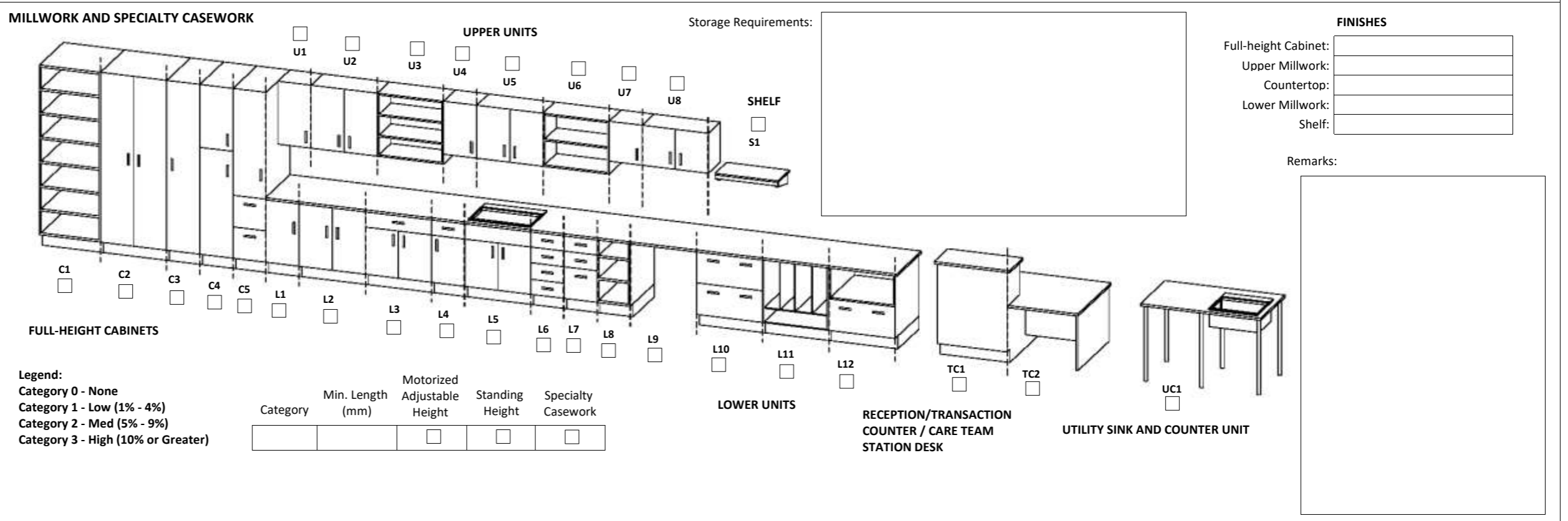

**MECHANICAL REQUIREMENTS**

<b>PLUMBING</b> (Quantity) Hand Hygiene Sink: <input type="text"/> Lavatory: <input type="text"/> Kitchen Sink: <input type="text"/> Seamless Kitchen Sink: <input type="text"/> Utility / Process Sink: <input type="text"/> Scrub Sink: <input type="text"/> Floor Sink: <input type="text"/> Plumbing Remarks: <input type="text"/>	Other Fixtures: <input type="checkbox"/> Shower <input type="checkbox"/> Eyewash Station <input type="checkbox"/> Tub <input type="checkbox"/> Eyewash/Shower Station <input type="checkbox"/> Ice Maker <input type="checkbox"/> Emergency Shower <input type="checkbox"/> Water Closet <input type="checkbox"/> Flush Rim Sink <input type="checkbox"/> Instantaneous Hot Water <input type="checkbox"/> Floor Drain <input type="checkbox"/> <input type="checkbox"/> Water Bottle Refill Station Other: <input type="text"/>	<b>MED / NON-MED GASES</b> (Quantity) Oxygen: <input type="text"/> Medical Air: <input type="text"/> Medical Vacuum: <input type="text"/> Nitrous Oxide: <input type="text"/> CO2: <input type="text"/> AGSS: <input type="text"/> Nitrogen: <input type="text"/> Laboratory Air: <input type="text"/> Laboratory Vacuum: <input type="text"/> Utility Compressed Air: <input type="text"/> Gas Remarks: <input type="text"/>
---	---	---



# Appendix 1B Minimum Room Requirements

Room Name:

Program Number(s):

1.	N3.01	7.		13.		19.		25.		31.		37.		43.
2.		8.		14.		20.		26.		32.		38.		44.
3.		9.		15.		21.		27.		33.		39.		45.
4.		10.		16.		22.		28.		34.		40.		46.
5.		11.		17.		23.		29.		35.		41.		47.
6.		12.		18.		24.		30.		36.		42.		48.

## ARCHITECTURAL REQUIREMENTS

<b>WALL AND CEILING</b> Wall Material: <input type="text" value="ARGB 1.2m AFF, GB above"/> Finish: <input type="text" value="PT"/> Ceiling Material: <input type="text" value="ACT"/> Finish: <input type="text" value="PF"/>		<b>WALL PROTECTION</b> Type: <input type="text" value="PVW"/> <input checked="" type="checkbox"/> Corner Guards <input type="checkbox"/> Hand Rails <input type="checkbox"/> Bed Bumper / Locator Height: <input type="text" value="1350 mm"/> <input type="checkbox"/> Crash Rails <input checked="" type="checkbox"/> Chair Rail			<b>GLAZING</b> <input checked="" type="checkbox"/> Interior Glazing		<b>FLOORING TYPES</b> Material: <input type="text" value="VSF"/> Base: <input type="text" value="RB"/>		<b>ROOM ACCESSORIES</b> <input checked="" type="checkbox"/> Coat Hooks <input type="checkbox"/> Ceiling Lift <input checked="" type="checkbox"/> Magnetic Whiteboard <input type="checkbox"/> Mirror <input type="checkbox"/> Infant Change Table <input type="checkbox"/> Privacy Curtain		
--	--	--	--	--	--	--	---	--	--	--	--

- LEGEND:**
- WALL AND CEILING LEGEND:**
- AC Architectural Ceiling
  - ACT Acoustic Ceiling Tile
  - ACT-C Cleanroom
  - ARGB Abuse-Resistant Gypsum Board
  - GB Gypsum Board
  - IRGB Impact-Resistant Gypsum Board
  - KLCT Kitchen Lay-in Ceiling Tile
  - MMRGB Moisture and Mould-Resistant Gypsum Board
  - SACT Security Acoustic Ceiling Tile
- WALL FINISHES LEGEND:**
- EWC Epoxy Wall Coating
  - HPC High Performance Coating
  - PT Paint
- CEILING FINISHES LEGEND:**
- ECC Epoxy Ceiling Coating
  - HPC High Performance Coating
  - PF Prefinished
  - PT Paint
- WALL PROTECTION LEGEND:**
- ESRP Extruded Semi-Rigid PVCu Panel
  - FRL Fibre Reinforced Laminate
  - FRP Fibreglass Reinforced Plastic
  - PVW Protective Vinyl Wallcovering
  - RHIS Rigid High Impact Sheet
  - WSSP Wetwall Solid Surface Panel
  - WVV Wetroom Vinyl Wallcovering
- FLOOR FINISHES LEGEND:**
- CFS Concrete Floor Sealer
  - EFC Epoxy Floor Coating
  - PFC Polyurethane Floor Coating
  - RAF Rubber Athletic Flooring
  - RSF Rubber Sheet Flooring
  - SCF Seamless Cushioned Flooring
  - SDRF Static-Dissipative Rubber Sheet Flooring
  - SDVF Static-Dissipative Vinyl Sheet Flooring
  - VSF Vinyl Sheet Flooring
  - WSVF Wetroom Safety Vinyl Sheet Flooring
- FLOOR BASE LEGEND:**
- FCB Flash Cove Base
  - RB Rubber Base
  - SCF Seamless Cushioned Flooring

**DOORS**

Types:

Type	Qty	Size (mm)	Material	Finish	Side Lt.	Blinds	Protect.	Privacy Film	Function	Card Reader	Mag Lock	Auto Opener	Hold Open	Hinges	Accessory 1	Accessory 2	Accessory 3	Closer
C	1	1065 x 2135	Solid Core	FRL	<input type="checkbox"/>	<input type="checkbox"/>	2 High	<input type="checkbox"/>	Storeroom	<input checked="" type="checkbox"/>	<input type="checkbox"/>	<input type="checkbox"/>	<input type="checkbox"/>	Butt Hinge				Surface

Door Remarks:  Security Grille  Anti-barricade strategy



## MECHANICAL REQUIREMENTS

<b>PLUMBING</b> (Quantity) Hand Hygiene Sink: <input type="text"/> Lavatory: <input type="text"/> Kitchen Sink: <input type="text"/> Seamless Kitchen Sink: <input type="text"/> Utility / Process Sink: <input type="text"/> Scrub Sink: <input type="text"/> Floor Sink: <input type="text"/>							Other Fixtures: <input type="checkbox"/> Shower <input type="checkbox"/> Eyewash Station <input type="checkbox"/> Tub <input type="checkbox"/> Eyewash/Shower Station <input type="checkbox"/> Ice Maker <input type="checkbox"/> Emergency Shower <input type="checkbox"/> Water Closet <input type="checkbox"/> Flush Rim Sink <input type="checkbox"/> Instantaneous Hot Water <input type="checkbox"/> Floor Drain <input type="checkbox"/> Water Bottle Refill Station Other: <input type="text"/>				<b>MED / NON-MED GASES</b> (Quantity) Oxygen: <input type="text"/> Medical Air: <input type="text"/> Medical Vacuum: <input type="text"/> Nitrous Oxide: <input type="text"/> CO2: <input type="text"/> AGSS: <input type="text"/> Nitrogen: <input type="text"/> Laboratory Air: <input type="text"/> Laboratory Vacuum: <input type="text"/> Utility Compressed Air: <input type="text"/>					
Plumbing Remarks: <input type="text"/>											Gas Remarks: <input type="text"/>					

**Appendix 1B Minimum Room Requirements**

Room Name:

Program Number(s):

1.	W3.03	7.		13.		19.		25.		31.		37.		43.
2.		8.		14.		20.		26.		32.		38.		44.
3.		9.		15.		21.		27.		33.		39.		45.
4.		10.		16.		22.		28.		34.		40.		46.
5.		11.		17.		23.		29.		35.		41.		47.
6.		12.		18.		24.		30.		36.		42.		48.

**ARCHITECTURAL REQUIREMENTS**

<b>WALL AND CEILING</b> Wall Material: <input type="text" value="ARGB 1.2m AFF, GB above"/> Finish: <input type="text" value="PT"/> Ceiling Material: <input type="text" value="ACT"/> Finish: <input type="text" value="PF"/>	<b>WALL PROTECTION</b> Type: <input type="text" value="RHIS"/> <input checked="" type="checkbox"/> Corner Guards <input type="checkbox"/> Hand Rails <input type="checkbox"/> Bed Bumper / Locator Height: <input type="text" value="2185 mm"/> <input type="checkbox"/> Crash Rails <input checked="" type="checkbox"/> Chair Rail	<b>GLAZING</b> <input checked="" type="checkbox"/> Interior Glazing	<b>FLOORING TYPES</b> Material: <input type="text" value="EFC"/> Base: <input type="text" value="RB"/>	<b>ROOM ACCESSORIES</b> <input checked="" type="checkbox"/> Coat Hooks <input type="checkbox"/> Ceiling Lift <input checked="" type="checkbox"/> Magnetic Whiteboard <input type="checkbox"/> Mirror <input type="checkbox"/> Infant Change Table <input type="checkbox"/> Privacy Curtain
--	---	--	---	--

- LEGEND:**
- WALL AND CEILING LEGEND:**
- AC Architectural Ceiling
  - ACT Acoustic Ceiling Tile
  - ACT-C Cleanroom
  - ARGB Abuse-Resistant Gypsum Board
  - GB Gypsum Board
  - IRGB Impact-Resistant Gypsum Board
  - KLCT Kitchen Lay-in Ceiling Tile
  - MMRGB Moisture and Mould-Resistant Gypsum Board
  - SACT Security Acoustic Ceiling Tile
- WALL FINISHES LEGEND:**
- EWC Epoxy Wall Coating
  - HPC High Performance Coating
  - PT Paint
- CEILING FINISHES LEGEND:**
- ECC Epoxy Ceiling Coating
  - HPC High Performance Coating
  - PF Prefinished
  - PT Paint
- WALL PROTECTION LEGEND:**
- ESRP Extruded Semi-Rigid PVCu Panel
  - FRL Fibre Reinforced Laminate
  - FRP Fibreglass Reinforced Plastic
  - PVV Protective Vinyl Wallcovering
  - RHIS Rigid High Impact Sheet
  - WSSP Wetwall Solid Surface Panel
  - WVV Wetroom Vinyl Wallcovering
- FLOOR FINISHES LEGEND:**
- CFS Concrete Floor Sealer
  - EFC Epoxy Floor Coating
  - PFC Polyurethane Floor Coating
  - RAF Rubber Athletic Flooring
  - RSF Rubber Sheet Flooring
  - SCF Seamless Cushioned Flooring
  - SDRF Static-Dissipative Rubber Sheet Flooring
  - SDVF Static-Dissipative Vinyl Sheet Flooring
  - VSF Vinyl Sheet Flooring
  - WSVF Wetroom Safety Vinyl Sheet Flooring
- FLOOR BASE LEGEND:**
- FCB Flash Cove Base
  - RB Rubber Base
  - SCF Seamless Cushioned Flooring

**DOORS**

Types:

Type	Qty	Size (mm)	Material	Finish	Side Lt.	Blinds	Protect.	Privacy Film	Function	Card Reader	Mag Lock	Auto Opener	Hold Open	Hinges	Accessory 1	Accessory 2	Accessory 3	Closer
B	1	915 x 2135	Solid Core	FRL	<input type="checkbox"/>	<input type="checkbox"/>	2 High	<input type="checkbox"/>	Storeroom	<input checked="" type="checkbox"/>	<input type="checkbox"/>	<input type="checkbox"/>	<input type="checkbox"/>	Butt Hinge				Surface

Door Remarks:  Security Grille  Anti-barricade strategy

**MILLWORK AND SPECIALTY CASEWORK**

Storage Requirements:

**UPPER UNITS** (U1-U8)

**LOWER UNITS** (L1-L12)

**RECEPTION/TRANSACTION COUNTER / CARE TEAM STATION DESK** (TC1, TC2)

**UTILITY SINK AND COUNTER UNIT** (UC1)

**SHelf** (S1)

**Full-height Cabinets** (C1-C5)

Category	Min. Length (mm)	Motorized Adjustable Height	Standing Height	Specialty Casework
2	3000	<input checked="" type="checkbox"/>	<input checked="" type="checkbox"/>	<input type="checkbox"/>

**FINISHES**

- Full-height Cabinet:
- Upper Millwork:
- Countertop:
- Lower Millwork:
- Shelf:

Remarks:

**MECHANICAL REQUIREMENTS**

<b>PLUMBING</b> (Quantity) Hand Hygiene Sink: <input type="text"/> Lavatory: <input type="text"/> Kitchen Sink: <input type="text"/> Seamless Kitchen Sink: <input type="text"/> Utility / Process Sink: <input type="text"/> Scrub Sink: <input type="text"/> Floor Sink: <input type="text"/> Plumbing Remarks: <input type="text"/>	Other Fixtures: <input type="checkbox"/> Shower <input type="checkbox"/> Eyewash Station <input type="checkbox"/> Tub <input type="checkbox"/> Eyewash/Shower Station <input type="checkbox"/> Ice Maker <input type="checkbox"/> Emergency Shower <input type="checkbox"/> Water Closet <input type="checkbox"/> Flush Rim Sink <input type="checkbox"/> Instantaneous Hot Water <input type="checkbox"/> Floor Drain <input type="checkbox"/> <input type="checkbox"/> Water Bottle Refill Station Other: <input type="text"/>	<b>MED / NON-MED GASES</b> (Quantity) Oxygen: <input type="text"/> Medical Air: <input type="text"/> Medical Vacuum: <input type="text"/> Nitrous Oxide: <input type="text"/> CO2: <input type="text"/> AGSS: <input type="text"/> Nitrogen: <input type="text"/> Laboratory Air: <input type="text"/> Laboratory Vacuum: <input type="text"/> Utility Compressed Air: <input type="text"/> Gas Remarks: <input type="text"/>
---	---	---

**Appendix 1B Minimum Room Requirements**

Room Name:

Program Number(s):	1. G1.08	7.	13.	19.	25.	31.	37.	43.
	2. M2.27	8.	14.	20.	26.	32.	38.	44.
	3.	9.	15.	21.	27.	33.	39.	45.
	4.	10.	16.	22.	28.	34.	40.	46.
	5.	11.	17.	23.	29.	35.	41.	47.
	6.	12.	18.	24.	30.	36.	42.	48.

**ARCHITECTURAL REQUIREMENTS**

<b>WALL AND CEILING</b> Wall Material: <input type="text" value="ARGB 1.2m AFF, GB above"/> Finish: <input type="text" value="PT"/> Ceiling Material: <input type="text" value="ACT"/> Finish: <input type="text" value="PF"/>	<b>WALL PROTECTION</b> Type: <input type="text" value="PVW"/> <input checked="" type="checkbox"/> Corner Guards <input type="checkbox"/> Hand Rails <input type="checkbox"/> Bed Bumper / Locator Height: <input type="text" value="1350 mm"/> <input type="checkbox"/> Crash Rails <input checked="" type="checkbox"/> Chair Rail	<b>GLAZING</b> <input checked="" type="checkbox"/> Interior Glazing	<b>FLOORING TYPES</b> Material: <input type="text" value="VSF"/> Base: <input type="text" value="FCB"/>	<b>ROOM ACCESSORIES</b> <input checked="" type="checkbox"/> Coat Hooks <input type="checkbox"/> Ceiling Lift <input checked="" type="checkbox"/> Magnetic Whiteboard <input type="checkbox"/> Mirror <input type="checkbox"/> Infant Change Table <input type="checkbox"/> Privacy Curtain
--	--	--	--	--

- LEGEND:**
- WALL AND CEILING LEGEND:**
- AC Architectural Ceiling
  - ACT Acoustic Ceiling Tile
  - ACT-C Cleanroom
  - ARGB Abuse-Resistant Gypsum Board
  - GB Gypsum Board
  - IRGB Impact-Resistant Gypsum Board
  - KLCT Kitchen Lay-in Ceiling Tile
  - MMRGB Moisture and Mould-Resistant Gypsum Board
  - SACT Security Acoustic Ceiling Tile
- WALL FINISHES LEGEND:**
- EWC Epoxy Wall Coating
  - HPC High Performance Coating
  - PT Paint
- CEILING FINISHES LEGEND:**
- ECC Epoxy Ceiling Coating
  - HPC High Performance Coating
  - PF Prefinished
  - PT Paint
- WALL PROTECTION LEGEND:**
- ESRP Extruded Semi-Rigid PVCu Panel
  - FRL Fibre Reinforced Laminate
  - FRP Fibreglass Reinforced Plastic
  - PVW Protective Vinyl Wallcovering
  - RHIS Rigid High Impact Sheet
  - WSSP Wetwall Solid Surface Panel
  - WVV Wetroom Vinyl Wallcovering
- FLOOR FINISHES LEGEND:**
- CFS Concrete Floor Sealer
  - EFC Epoxy Floor Coating
  - PFC Polyurethane Floor Coating
  - RAF Rubber Athletic Flooring
  - RSF Rubber Sheet Flooring
  - SCF Seamless Cushioned Flooring
  - SDRF Static-Dissipative Rubber Sheet Flooring
  - SDVF Static-Dissipative Vinyl Sheet Flooring
  - VSF Vinyl Sheet Flooring
  - WSVF Wetroom Safety Vinyl Sheet Flooring
- FLOOR BASE LEGEND:**
- FCB Flash Cove Base
  - RB Rubber Base
  - SCF Seamless Cushioned Flooring

**DOORS**

Types:

Type	Qty	Size (mm)	Material	Finish	Side Lt.	Blinds	Protect.	Film	Function	Card Reader	Mag Lock	Auto Opener	Hold Open	Hinges	Accessory 1	Accessory 2	Accessory 3	Closer
C	2	1065 x 2135	Solid Core	FRL	<input type="checkbox"/>	<input type="checkbox"/>	1 Low	<input type="checkbox"/>	Storeroom	<input checked="" type="checkbox"/>	<input type="checkbox"/>	<input type="checkbox"/>	<input type="checkbox"/>	Butt Hinge				Surface

Door Remarks:  Security Grille  Anti-barricade strategy

**MILLWORK AND SPECIALTY CASEWORK**

**UPPER UNITS** (U1-U8) **LOWER UNITS** (L1-L9)

**RECEPTION/TRANSACTION COUNTER / CARE TEAM STATION DESK** (TC1, TC2)

**UTILITY SINK AND COUNTER UNIT** (UC1)

**Storage Requirements:**  SHELF (S1)

Category	Min. Length (mm)	Motorized Adjustable Height	Standing Height	Specialty Casework
1	1800	<input type="checkbox"/>	<input checked="" type="checkbox"/>	<input type="checkbox"/>

**FINISHES**

Full-height Cabinet:

Upper Millwork:

Countertop:

Lower Millwork:

Shelf:

Remarks:

**MECHANICAL REQUIREMENTS**

<b>PLUMBING</b> (Quantity) Hand Hygiene Sink: <input type="text" value="1"/> Lavatory: <input type="text"/> Kitchen Sink: <input type="text"/> Seamless Kitchen Sink: <input type="text"/> Utility / Process Sink: <input type="text"/> Scrub Sink: <input type="text"/> Floor Sink: <input type="text"/> Plumbing Remarks: <input type="text" value="Provide HHS for G1.08"/>	Other Fixtures: <input type="checkbox"/> Shower <input type="checkbox"/> Eyewash Station <input type="checkbox"/> Tub <input type="checkbox"/> Eyewash/Shower Station <input type="checkbox"/> Ice Maker <input type="checkbox"/> Emergency Shower <input type="checkbox"/> Water Closet <input type="checkbox"/> Flush Rim Sink <input type="checkbox"/> Instantaneous Hot Water <input type="checkbox"/> Floor Drain <input type="checkbox"/> <input type="checkbox"/> Water Bottle Refill Station Other: <input type="text"/>	<b>MED / NON-MED GASES</b> (Quantity) Oxygen: <input type="text"/> Medical Air: <input type="text"/> Medical Vacuum: <input type="text"/> Nitrous Oxide: <input type="text"/> CO2: <input type="text"/> AGSS: <input type="text"/> Nitrogen: <input type="text"/> Laboratory Air: <input type="text"/> Laboratory Vacuum: <input type="text"/> Utility Compressed Air: <input type="text"/> Gas Remarks: <input type="text"/>
---	---	---



**Appendix 1B Minimum Room Requirements**

Room Name:

Program Number(s):

1. G3.02	7.	13.	19.	25.	31.	37.	43.
2. I3.02	8.	14.	20.	26.	32.	38.	44.
3.	9.	15.	21.	27.	33.	39.	45.
4.	10.	16.	22.	28.	34.	40.	46.
5.	11.	17.	23.	29.	35.	41.	47.
6.	12.	18.	24.	30.	36.	42.	48.

**ARCHITECTURAL REQUIREMENTS**

<b>WALL AND CEILING</b> Wall Material: <input type="text" value="ARGB 1.2m AFF, GB above"/> Finish: <input type="text" value="PT"/> Ceiling Material: <input type="text" value="ACT"/> Finish: <input type="text" value="PF"/>	<b>WALL PROTECTION</b> Type: <input type="text" value="PVW"/> <input checked="" type="checkbox"/> Corner Guards <input type="checkbox"/> Hand Rails <input type="checkbox"/> Bed Bumper / Locator Height: <input type="text" value="1350 mm"/> <input type="checkbox"/> Crash Rails <input checked="" type="checkbox"/> Chair Rail	<b>GLAZING</b> <input checked="" type="checkbox"/> Interior Glazing	<b>FLOORING TYPES</b> Material: <input type="text" value="VSF"/> Base: <input type="text" value="RB"/>	<b>ROOM ACCESSORIES</b> <input checked="" type="checkbox"/> Coat Hooks <input type="checkbox"/> Ceiling Lift <input checked="" type="checkbox"/> Magnetic Whiteboard <input type="checkbox"/> Mirror <input type="checkbox"/> Infant Change Table <input type="checkbox"/> Privacy Curtain
--	--	--	---	--

- LEGEND:**
- WALL AND CEILING LEGEND:**
- AC Architectural Ceiling
  - ACT Acoustic Ceiling Tile
  - ACT-C Cleanroom
  - ARGB Abuse-Resistant Gypsum Board
  - GB Gypsum Board
  - IRGB Impact-Resistant Gypsum Board
  - KLCT Kitchen Lay-in Ceiling Tile
  - MMRGB Moisture and Mould-Resistant Gypsum Board
  - SACT Security Acoustic Ceiling Tile
- WALL FINISHES LEGEND:**
- EWC Epoxy Wall Coating
  - HPC High Performance Coating
  - PT Paint
- CEILING FINISHES LEGEND:**
- ECC Epoxy Ceiling Coating
  - HPC High Performance Coating
  - PF Prefinished
  - PT Paint
- WALL PROTECTION LEGEND:**
- ESRP Extruded Semi-Rigid PVCu Panel
  - FRL Fibre Reinforced Laminate
  - FRP Fibreglass Reinforced Plastic
  - PVW Protective Vinyl Wallcovering
  - RHIS Rigid High Impact Sheet
  - WSSP Wetwall Solid Surface Panel
  - WVV Wetroom Vinyl Wallcovering
- FLOOR FINISHES LEGEND:**
- CFS Concrete Floor Sealer
  - EFC Epoxy Floor Coating
  - PFC Polyurethane Floor Coating
  - RAF Rubber Athletic Flooring
  - RSF Rubber Sheet Flooring
  - SCF Seamless Cushioned Flooring
  - SDRF Static-Dissipative Rubber Sheet Flooring
  - SDVF Static-Dissipative Vinyl Sheet Flooring
  - VSF Vinyl Sheet Flooring
  - WSVF Wetroom Safety Vinyl Sheet Flooring
- FLOOR BASE LEGEND:**
- FCB Flash Cove Base
  - RB Rubber Base
  - SCF Seamless Cushioned Flooring

**DOORS**

Types:

Type	Qty	Size (mm)	Material	Finish	Side Lt.	Blinds	Protect.	Privacy Film	Function	Card Reader	Mag Lock	Auto Opener	Hold Open	Hinges	Accessory 1	Accessory 2	Accessory 3	Closer
B	1	915 x 2135	Solid Core	FRL	<input type="checkbox"/>	<input type="checkbox"/>	2 High	<input type="checkbox"/>	Storeroom	<input checked="" type="checkbox"/>	<input type="checkbox"/>	<input type="checkbox"/>	<input type="checkbox"/>	Butt Hinge				Surface

Door Remarks:  Security Grille  Anti-barricade strategy

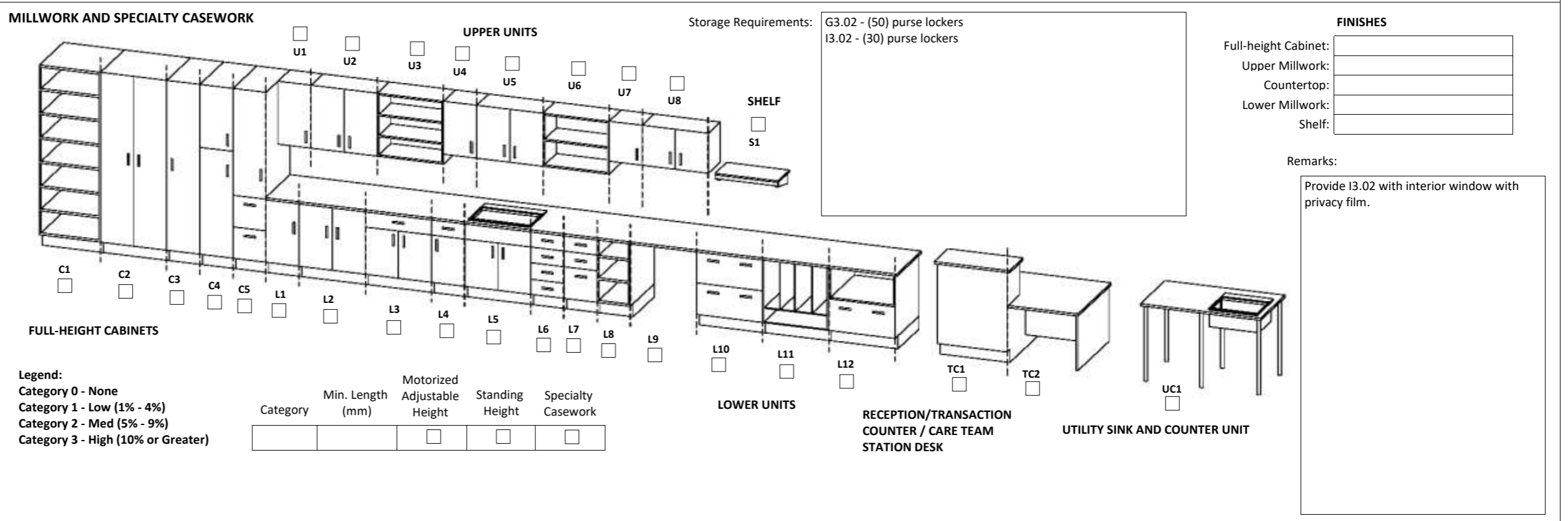

**MECHANICAL REQUIREMENTS**

<b>PLUMBING</b> (Quantity) Hand Hygiene Sink: <input type="text"/> Lavatory: <input type="text"/> Kitchen Sink: <input type="text"/> Seamless Kitchen Sink: <input type="text"/> Utility / Process Sink: <input type="text"/> Scrub Sink: <input type="text"/> Floor Sink: <input type="text"/> Plumbing Remarks: <input type="text"/>	Other Fixtures: <input type="checkbox"/> Shower <input type="checkbox"/> Eyewash Station <input type="checkbox"/> Tub <input type="checkbox"/> Eyewash/Shower Station <input type="checkbox"/> Ice Maker <input type="checkbox"/> Emergency Shower <input type="checkbox"/> Water Closet <input type="checkbox"/> Flush Rim Sink <input type="checkbox"/> Instantaneous Hot Water <input type="checkbox"/> Floor Drain <input type="checkbox"/> Water Bottle Refill Station Other <input type="text"/>	<b>MED / NON-MED GASES</b> (Quantity) Oxygen: <input type="text"/> Medical Air: <input type="text"/> Medical Vacuum: <input type="text"/> Nitrous Oxide: <input type="text"/> CO2: <input type="text"/> AGSS: <input type="text"/> Nitrogen: <input type="text"/> Laboratory Air: <input type="text"/> Laboratory Vacuum: <input type="text"/> Utility Compressed Air: <input type="text"/> Gas Remarks: <input type="text"/>
---	---	--

# Appendix 1B Minimum Room Requirements

Room Name:

Program Number(s):

1.	J5.05	7.		13.		19.		25.		31.		37.		43.
2.		8.		14.		20.		26.		32.		38.		44.
3.		9.		15.		21.		27.		33.		39.		45.
4.		10.		16.		22.		28.		34.		40.		46.
5.		11.		17.		23.		29.		35.		41.		47.
6.		12.		18.		24.		30.		36.		42.		48.

## ARCHITECTURAL REQUIREMENTS

<b>WALL AND CEILING</b> Wall Material: <input type="text" value="ARGB 1.2m AFF, GB above"/> Finish: <input type="text" value="EWC"/> Ceiling Material: <input type="text" value="ACT"/> Finish: <input type="text" value="PF"/>		<b>WALL PROTECTION</b> Type: <input type="text" value="ESRP"/> <input checked="" type="checkbox"/> Corner Guards <input type="checkbox"/> Hand Rails <input type="checkbox"/> Bed Bumper / Locator Height: <input type="text" value="2185 mm"/> <input type="checkbox"/> Crash Rails <input checked="" type="checkbox"/> Chair Rail			<b>GLAZING</b> <input type="checkbox"/> Interior Glazing		<b>FLOORING TYPES</b> Material: <input type="text" value="VSF"/> Base: <input type="text" value="RB"/>		<b>ROOM ACCESSORIES</b> <input checked="" type="checkbox"/> Coat Hooks <input type="checkbox"/> Ceiling Lift <input checked="" type="checkbox"/> Magnetic Whiteboard <input type="checkbox"/> Mirror <input type="checkbox"/> Infant Change Table <input type="checkbox"/> Privacy Curtain		
---	--	---	--	--	---	--	---	--	--	--	--

- LEGEND:**
- WALL AND CEILING LEGEND:**
- AC Architectural Ceiling
  - ACT Acoustic Ceiling Tile
  - ACT-C Cleanroom
  - ARGB Abuse-Resistant Gypsum Board
  - GB Gypsum Board
  - IRGB Impact-Resistant Gypsum Board
  - KLCT Kitchen Lay-in Ceiling Tile
  - MMRGB Moisture and Mould-Resistant Gypsum Board
  - SACT Security Acoustic Ceiling Tile
- WALL FINISHES LEGEND:**
- EWC Epoxy Wall Coating
  - HPC High Performance Coating
  - PT Paint
- CEILING FINISHES LEGEND:**
- ECC Epoxy Ceiling Coating
  - HPC High Performance Coating
  - PF Prefinished
  - PT Paint
- WALL PROTECTION LEGEND:**
- ESRP Extruded Semi-Rigid PVCu Panel
  - FRL Fibre Reinforced Laminate
  - FRP Fibreglass Reinforced Plastic
  - PVV Protective Vinyl Wallcovering
  - RHIS Rigid High Impact Sheet
  - WSSP Wetwall Solid Surface Panel
  - WVV Wetroom Vinyl Wallcovering
- FLOOR FINISHES LEGEND:**
- CFS Concrete Floor Sealer
  - EFC Epoxy Floor Coating
  - PFC Polyurethane Floor Coating
  - RAF Rubber Athletic Flooring
  - RSF Rubber Sheet Flooring
  - SCF Seamless Cushioned Flooring
  - SDRF Static-Dissipative Rubber Sheet Flooring
  - SDVF Static-Dissipative Vinyl Sheet Flooring
  - VSF Vinyl Sheet Flooring
  - WSVF Wetroom Safety Vinyl Sheet Flooring
- FLOOR BASE LEGEND:**
- FCB Flash Cove Base
  - RB Rubber Base
  - SCF Seamless Cushioned Flooring

**DOORS**

Types:

Type	Qty	Size (mm)	Material	Finish	Side Lt.	Blinds	Protect.	Privacy Film	Function	Card Reader	Mag Lock	Auto Opener	Hold Open	Hinges	Accessory 1	Accessory 2	Accessory 3	Closer
B	1	915 x 2135	Solid Core	FRL	<input type="checkbox"/>	<input type="checkbox"/>	2 High	<input checked="" type="checkbox"/>	Passage	<input type="checkbox"/>	<input type="checkbox"/>	<input type="checkbox"/>	<input type="checkbox"/>	Butt Hinge				Surface

Door Remarks:  Security Grille  Anti-barricade strategy

**MILLWORK AND SPECIALTY CASEWORK**

**UPPER UNITS** (U1-U8) **SHELF** (S1)

**LOWER UNITS** (L1-L12) **RECEPTION/TRANSACTION COUNTER / CARE TEAM STATION DESK** (TC1, TC2) **UTILITY SINK AND COUNTER UNIT** (UC1)

**FULL-HEIGHT CABINETS** (C1-C5)

Storage Requirements:

**FINISHES**

Full-height Cabinet:   
 Upper Millwork:   
 Countertop:   
 Lower Millwork:   
 Shelf:

Remarks:

**Legend:**

Category	Min. Length (mm)	Motorized Adjustable Height	Standing Height	Specialty Casework
Category 0 - None		<input type="checkbox"/>	<input type="checkbox"/>	<input type="checkbox"/>
Category 1 - Low (1% - 4%)		<input type="checkbox"/>	<input type="checkbox"/>	<input type="checkbox"/>
Category 2 - Med (5% - 9%)		<input type="checkbox"/>	<input type="checkbox"/>	<input type="checkbox"/>
Category 3 - High (10% or Greater)		<input type="checkbox"/>	<input type="checkbox"/>	<input type="checkbox"/>

## MECHANICAL REQUIREMENTS

<b>PLUMBING</b> (Quantity) Hand Hygiene Sink: <input type="text"/> Lavatory: <input type="text"/> Kitchen Sink: <input type="text"/> Seamless Kitchen Sink: <input type="text"/> Utility / Process Sink: <input type="text"/> Scrub Sink: <input type="text"/> Floor Sink: <input type="text"/>							Other Fixtures: <input type="checkbox"/> Shower <input type="checkbox"/> Eyewash Station <input type="checkbox"/> Tub <input type="checkbox"/> Eyewash/Shower Station <input type="checkbox"/> Ice Maker <input type="checkbox"/> Emergency Shower <input type="checkbox"/> Water Closet <input type="checkbox"/> Flush Rim Sink <input type="checkbox"/> Instantaneous Hot Water <input type="checkbox"/> Floor Drain <input type="checkbox"/> Water Bottle Refill Station Other <input type="text"/>				<b>MED / NON-MED GASES</b> (Quantity) Oxygen: <input type="text"/> Medical Air: <input type="text"/> Medical Vacuum: <input type="text"/> Nitrous Oxide: <input type="text"/> CO2: <input type="text"/> AGSS: <input type="text"/> Nitrogen: <input type="text"/> Laboratory Air: <input type="text"/> Laboratory Vacuum: <input type="text"/> Utility Compressed Air: <input type="text"/>					
Plumbing Remarks: <input type="text"/>							Gas Remarks: <input type="text"/>									

**Appendix 1B Minimum Room Requirements**

Room Name:

Program Number(s):

1. R4.03	7.	13.	19.	25.	31.	37.	43.
2.	8.	14.	20.	26.	32.	38.	44.
3.	9.	15.	21.	27.	33.	39.	45.
4.	10.	16.	22.	28.	34.	40.	46.
5.	11.	17.	23.	29.	35.	41.	47.
6.	12.	18.	24.	30.	36.	42.	48.

**ARCHITECTURAL REQUIREMENTS**

<b>WALL AND CEILING</b> Wall Material: <input type="text" value="ARGB 1.2m AFF, GB above"/> Finish: <input type="text" value="EWC"/> Ceiling Material: <input type="text" value="ACT"/> Finish: <input type="text" value="PF"/>		<b>WALL PROTECTION</b> Type: <input type="text" value="ESRP"/> <input checked="" type="checkbox"/> Corner Guards <input type="checkbox"/> Hand Rails <input type="checkbox"/> Bed Bumper / Locator Height: <input type="text" value="2185 mm"/> <input type="checkbox"/> Crash Rails <input checked="" type="checkbox"/> Chair Rail		<b>GLAZING</b> <input type="checkbox"/> Interior Glazing		<b>FLOORING TYPES</b> Material: <input type="text" value="VSF"/> Base: <input type="text" value="RB"/>		<b>ROOM ACCESSORIES</b> <input checked="" type="checkbox"/> Coat Hooks <input type="checkbox"/> Ceiling Lift <input checked="" type="checkbox"/> Magnetic Whiteboard <input type="checkbox"/> Mirror <input type="checkbox"/> Infant Change Table <input type="checkbox"/> Privacy Curtain	
---	--	---	--	---	--	---	--	--	--

- LEGEND:**
- WALL AND CEILING LEGEND:**
- AC Architectural Ceiling
  - ACT Acoustic Ceiling Tile
  - ACT-C Cleanroom
  - ARGB Abuse-Resistant Gypsum Board
  - GB Gypsum Board
  - IRGB Impact-Resistant Gypsum Board
  - KLCT Kitchen Lay-in Ceiling Tile
  - MMRGB Moisture and Mould-Resistant Gypsum Board
  - SACT Security Acoustic Ceiling Tile
- WALL FINISHES LEGEND:**
- EWC Epoxy Wall Coating
  - HPC High Performance Coating
  - PT Paint
- CEILING FINISHES LEGEND:**
- ECC Epoxy Ceiling Coating
  - HPC High Performance Coating
  - PF Prefinished
  - PT Paint
- WALL PROTECTION LEGEND:**
- ESRP Extruded Semi-Rigid PVCu Panel
  - FRL Fibre Reinforced Laminate
  - FRP Fibreglass Reinforced Plastic
  - PVV Protective Vinyl Wallcovering
  - RHIS Rigid High Impact Sheet
  - WSSP Wetwall Solid Surface Panel
  - WVV Wetroom Vinyl Wallcovering
- FLOOR FINISHES LEGEND:**
- CFS Concrete Floor Sealer
  - EFC Epoxy Floor Coating
  - PFC Polyurethane Floor Coating
  - RAF Rubber Athletic Flooring
  - RSF Rubber Sheet Flooring
  - SCF Seamless Cushioned Flooring
  - SDRF Static-Dissipative Rubber Sheet Flooring
  - SDVF Static-Dissipative Vinyl Sheet Flooring
  - VSF Vinyl Sheet Flooring
  - WSVF Wetroom Safety Vinyl Sheet Flooring
- FLOOR BASE LEGEND:**
- FCB Flash Cove Base
  - RB Rubber Base
  - SCF Seamless Cushioned Flooring

**DOORS**

Types:

Type:Qty:	Size (mm):	Material:	Finish:	Side Lt:	Blinds:	Protect.:	Privacy Film:	Function:	Card Reader:	Mag Lock:	Auto Opener:	Hold Open:	Hinges:	Accessory 1:	Accessory 2:	Accessory 3:	Closer:

Door Remarks:  Security Grille  Anti-barricade strategy

**MILLWORK AND SPECIALTY CASEWORK**

Storage Requirements:

**UPPER UNITS** (U1-U8) **SHELF** (S1)

**LOWER UNITS** (L1-L12) **RECEPTION/TRANSACTION COUNTER / CARE TEAM STATION DESK** (TC1, TC2) **UTILITY SINK AND COUNTER UNIT** (UC1)

**FULL-HEIGHT CABINETS** (C1-C5)

**Legend:**

Category	Min. Length (mm)	Motorized Adjustable Height	Standing Height	Specialty Casework
Category 0 - None				
Category 1 - Low (1% - 4%)				
Category 2 - Med (5% - 9%)				
Category 3 - High (10% or Greater)				

**FINISHES**

Full-height Cabinet:   
 Upper Millwork:   
 Countertop:   
 Lower Millwork:   
 Shelf:

Remarks:

**MECHANICAL REQUIREMENTS**

**PLUMBING** (Quantity)

Hygiene Sink:	Lavatory:	Kitchen Sink:	Seamless Kitchen Sink:	Utility / Process Sink:	Scrub Sink:	Floor Sink:

Plumbing Remarks:

**Other Fixtures:**

- Shower
- Tub
- Ice Maker
- Water Closet
- Instantaneous Hot Water
- Eyewash Station
- Eyewash/Shower Station
- Emergency Shower
- Flush Rim Sink
- Floor Drain
- Water Bottle Refill Station

Other:

**MED / NON-MED GASES** (Quantity)

Oxygen:	Medical Air:	Medical Vacuum:	Nitrous Oxide:	CO2:	AGSS:	Nitrogen:	Laboratory Air:	Laboratory Vacuum:	Utility Compressed Air:

Gas Remarks:



**Appendix 1B Minimum Room Requirements**

Room Name:

Program Number(s):

1. K1.08	7.	13.	19.	25.	31.	37.	43.
2.	8.	14.	20.	26.	32.	38.	44.
3.	9.	15.	21.	27.	33.	39.	45.
4.	10.	16.	22.	28.	34.	40.	46.
5.	11.	17.	23.	29.	35.	41.	47.
6.	12.	18.	24.	30.	36.	42.	48.

**ARCHITECTURAL REQUIREMENTS**

<b>WALL AND CEILING</b> Wall Material: <input type="text" value="ARGB 1.2m AFF, GB above"/> Finish: <input type="text" value="PT"/> Ceiling Material: <input type="text" value="ACT"/> Finish: <input type="text" value="PF"/>	<b>WALL PROTECTION</b> Type: <input type="text" value="RHIS"/> <input checked="" type="checkbox"/> Corner Guards <input type="checkbox"/> Hand Rails <input type="checkbox"/> Bed Bumper / Locator Height: <input type="text" value="1350 mm"/> <input type="checkbox"/> Crash Rails <input checked="" type="checkbox"/> Chair Rail	<b>GLAZING</b> <input type="checkbox"/> Interior Glazing	<b>FLOORING TYPES</b> Material: <input type="text" value="VSF"/> Base: <input type="text" value="RB"/>	<b>ROOM ACCESSORIES</b> <input checked="" type="checkbox"/> Coat Hooks <input type="checkbox"/> Ceiling Lift <input checked="" type="checkbox"/> Magnetic Whiteboard <input type="checkbox"/> Mirror <input type="checkbox"/> Infant Change Table <input type="checkbox"/> Privacy Curtain
--	---	---	---	--

- LEGEND:**
- WALL AND CEILING LEGEND:**
- AC Architectural Ceiling
  - ACT Acoustic Ceiling Tile
  - ACT-C Cleanroom
  - ARGB Abuse-Resistant Gypsum Board
  - GB Gypsum Board
  - IRGB Impact-Resistant Gypsum Board
  - KLCT Kitchen Lay-in Ceiling Tile
  - MMRGB Moisture and Mould-Resistant Gypsum Board
  - SACT Security Acoustic Ceiling Tile
- WALL FINISHES LEGEND:**
- EWC Epoxy Wall Coating
  - HPC High Performance Coating
  - PT Paint
- CEILING FINISHES LEGEND:**
- ECC Epoxy Ceiling Coating
  - HPC High Performance Coating
  - PF Prefinished
  - PT Paint
- WALL PROTECTION LEGEND:**
- ESRP Extruded Semi-Rigid PVCu Panel
  - FRL Fibre Reinforced Laminata
  - FRP Fibreglass Reinforced Plastic
  - PVV Protective Vinyl Wallcovering
  - RHIS Rigid High Impact Sheet
  - WSSP Wetwall Solid Surface Panel
  - WVV Wetroom Vinyl Wallcovering
- FLOOR FINISHES LEGEND:**
- CFS Concrete Floor Sealer
  - EFC Epoxy Floor Coating
  - PFC Polyurethane Floor Coating
  - RAF Rubber Athletic Flooring
  - RSF Rubber Sheet Flooring
  - SCF Seamless Cushioned Flooring
  - SDRF Static-Dissipative Rubber Sheet Flooring
  - SDVF Static-Dissipative Vinyl Sheet Flooring
  - VSF Vinyl Sheet Flooring
  - WSVF Wetroom Safety Vinyl Sheet Flooring
- FLOOR BASE LEGEND:**
- FCB Flash Cove Base
  - RB Rubber Base
  - SCF Seamless Cushioned Flooring

**DOORS**

Types:

Type	Qty	Size (mm)	Material	Finish	Side Lt.	Blinds	Protect.	Privacy Film	Function	Card Reader	Mag Lock	Auto Opener	Hold Open	Hinges	Accessory 1	Accessory 2	Accessory 3	Closer
B	1	915 x 2135	Solid Core	FRL	<input type="checkbox"/>	<input type="checkbox"/>	2 High	<input checked="" type="checkbox"/>	Storeroom	<input checked="" type="checkbox"/>	<input type="checkbox"/>	<input type="checkbox"/>	<input type="checkbox"/>	Butt Hinge				Surface

Door Remarks:  Security Grille  Anti-barricade strategy



**MECHANICAL REQUIREMENTS**

<b>PLUMBING</b> (Quantity) Hand Hygiene Sink: <input type="text"/> Lavatory: <input type="text"/> Kitchen Sink: <input type="text"/> Seamless Kitchen Sink: <input type="text"/> Utility / Process Sink: <input type="text"/> Scrub Sink: <input type="text"/> Floor Sink: <input type="text"/> Plumbing Remarks: <input type="text"/>	Other Fixtures: <input type="checkbox"/> Shower <input type="checkbox"/> Tub <input type="checkbox"/> Ice Maker <input type="checkbox"/> Water Closet <input type="checkbox"/> Instantaneous Hot Water <input type="checkbox"/> Eyewash Station <input type="checkbox"/> Eyewash/Shower Station <input type="checkbox"/> Emergency Shower <input type="checkbox"/> Flush Rim Sink <input type="checkbox"/> Floor Drain <input type="checkbox"/> Water Bottle Refill Station Other: <input type="text"/>	<b>MED / NON-MED GASES</b> (Quantity) Oxygen: <input type="text"/> Medical Air: <input type="text"/> Medical Vacuum: <input type="text"/> Nitrous Oxide: <input type="text"/> CO2: <input type="text"/> AGSS: <input type="text"/> Nitrogen: <input type="text"/> Laboratory Air: <input type="text"/> Laboratory Vacuum: <input type="text"/> Utility Compressed Air: <input type="text"/> Gas Remarks: <input type="text"/>
---	--	---

# Appendix 1B Minimum Room Requirements

Room Name:

Program Number(s):

1. K1.03	7.	13.	19.	25.	31.	37.	43.
2.	8.	14.	20.	26.	32.	38.	44.
3.	9.	15.	21.	27.	33.	39.	45.
4.	10.	16.	22.	28.	34.	40.	46.
5.	11.	17.	23.	29.	35.	41.	47.
6.	12.	18.	24.	30.	36.	42.	48.

## ARCHITECTURAL REQUIREMENTS

<b>WALL AND CEILING</b> Wall Material: <input type="text" value="ARGB 1.2m AFF, GB above"/> Finish: <input type="text" value="PT"/> Ceiling Material: <input type="text" value="ACT"/> Finish: <input type="text" value="PF"/>	<b>WALL PROTECTION</b> Type: <input type="text" value="RHIS"/> <input checked="" type="checkbox"/> Corner Guards <input type="checkbox"/> Hand Rails <input type="checkbox"/> Bed Bumper / Locator Height: <input type="text" value="1350 mm"/> <input type="checkbox"/> Crash Rails <input checked="" type="checkbox"/> Chair Rail	<b>GLAZING</b> <input checked="" type="checkbox"/> Interior Glazing	<b>FLOORING TYPES</b> Material: <input type="text" value="VSF"/> Base: <input type="text" value="RB"/>	<b>ROOM ACCESSORIES</b> <input checked="" type="checkbox"/> Coat Hooks <input type="checkbox"/> Ceiling Lift <input checked="" type="checkbox"/> Magnetic Whiteboard <input type="checkbox"/> Mirror <input type="checkbox"/> Infant Change Table <input type="checkbox"/> Privacy Curtain
--	---	--	---	--

- LEGEND:**
- WALL AND CEILING LEGEND:**
- AC Architectural Ceiling
  - ACT Acoustic Ceiling Tile
  - ACT-C Cleanroom
  - ARGB Abuse-Resistant Gypsum Board
  - GB Gypsum Board
  - IRGB Impact-Resistant Gypsum Board
  - KLCT Kitchen Lay-in Ceiling Tile
  - MMRGB Moisture and Mould-Resistant Gypsum Board
  - SACT Security Acoustic Ceiling Tile
- WALL FINISHES LEGEND:**
- EWC Epoxy Wall Coating
  - HPC High Performance Coating
  - PT Paint
- CEILING FINISHES LEGEND:**
- ECC Epoxy Ceiling Coating
  - HPC High Performance Coating
  - PF Prefinished
  - PT Paint
- WALL PROTECTION LEGEND:**
- ESRP Extruded Semi-Rigid PVCu Panel
  - FRL Fibre Reinforced Laminate
  - FRP Fibreglass Reinforced Plastic
  - PVV Protective Vinyl Wallcovering
  - RHIS Rigid High Impact Sheet
  - WSSP Wetwall Solid Surface Panel
  - WVV Wetroom Vinyl Wallcovering
- FLOOR FINISHES LEGEND:**
- CFS Concrete Floor Sealer
  - EFC Epoxy Floor Coating
  - PFC Polyurethane Floor Coating
  - RAF Rubber Athletic Flooring
  - RSF Rubber Sheet Flooring
  - SCF Seamless Cushioned Flooring
  - SDRF Static-Dissipative Rubber Sheet Flooring
  - SDVF Static-Dissipative Vinyl Sheet Flooring
  - VSF Vinyl Sheet Flooring
  - WSVF Wetroom Safety Vinyl Sheet Flooring
- FLOOR BASE LEGEND:**
- FCB Flash Cove Base
  - RB Rubber Base
  - SCF Seamless Cushioned Flooring

**DOORS**

Types:

Type	Qty	Size (mm)	Material	Finish	Side Lt.	Blinds	Protect.	Privacy Film	Function	Card Reader	Mag Lock	Auto Opener	Hold Open	Hinges	Accessory 1	Accessory 2	Accessory 3	Closer
B	1	915 x 2135	Solid Core	FRL	<input type="checkbox"/>	<input type="checkbox"/>	2 High	<input checked="" type="checkbox"/>	Storeroom	<input checked="" type="checkbox"/>	<input type="checkbox"/>	<input type="checkbox"/>	<input type="checkbox"/>	Butt Hinge				Surface

Door Remarks:  Security Grille  Anti-barricade strategy

**MILLWORK AND SPECIALTY CASEWORK**

**UPPER UNITS** (U1-U8) **LOWER UNITS** (L1-L12) **RECEPTION/TRANSACTION COUNTER / CARE TEAM STATION DESK** (TC1-TC2) **UTILITY SINK AND COUNTER UNIT** (UC1)

Storage Requirements:

**FINISHES**

Full-height Cabinet:   
 Upper Millwork:   
 Countertop:   
 Lower Millwork:   
 Shelf:

Remarks:

**Legend:**

Category	Min. Length (mm)	Motorized Adjustable Height	Standing Height	Specialty Casework
2	1800	<input type="checkbox"/>	<input type="checkbox"/>	<input type="checkbox"/>

## MECHANICAL REQUIREMENTS

<b>PLUMBING</b> (Quantity) Hand Hygiene Sink: <input type="text"/> Lavatory: <input type="text"/> Kitchen Sink: <input type="text"/> Seamless Kitchen Sink: <input type="text"/> Utility / Process Sink: <input type="text"/> Scrub Sink: <input type="text"/> Floor Sink: <input type="text"/> Plumbing Remarks: <input type="text"/>	Other Fixtures: <input type="checkbox"/> Shower <input type="checkbox"/> Eyewash Station <input type="checkbox"/> Tub <input type="checkbox"/> Eyewash/Shower Station <input type="checkbox"/> Ice Maker <input type="checkbox"/> Emergency Shower <input type="checkbox"/> Water Closet <input type="checkbox"/> Flush Rim Sink <input type="checkbox"/> Instantaneous Hot Water <input type="checkbox"/> Floor Drain <input type="checkbox"/> <input type="checkbox"/> Water Bottle Refill Station Other: <input type="text"/>	<b>MED / NON-MED GASES</b> (Quantity) Oxygen: <input type="text"/> Medical Air: <input type="text"/> Medical Vacuum: <input type="text"/> Nitrous Oxide: <input type="text"/> CO2: <input type="text"/> AGSS: <input type="text"/> Nitrogen: <input type="text"/> Laboratory Air: <input type="text"/> Laboratory Vacuum: <input type="text"/> Utility Compressed Air: <input type="text"/> Gas Remarks: <input type="text"/>
---	---	---

# Appendix 1B Minimum Room Requirements

Room Name:

Program Number(s):

1. K1.09	7.	13.	19.	25.	31.	37.	43.
2.	8.	14.	20.	26.	32.	38.	44.
3.	9.	15.	21.	27.	33.	39.	45.
4.	10.	16.	22.	28.	34.	40.	46.
5.	11.	17.	23.	29.	35.	41.	47.
6.	12.	18.	24.	30.	36.	42.	48.

## ARCHITECTURAL REQUIREMENTS

<b>WALL AND CEILING</b> Wall Material: <input type="text" value="ARGB 1.2m AFF, GB above"/> Finish: <input type="text" value="PT"/> Ceiling Material: <input type="text" value="ACT"/> Finish: <input type="text" value="PF"/>	<b>WALL PROTECTION</b> Type: <input type="text" value="RHIS"/> <input checked="" type="checkbox"/> Corner Guards <input type="checkbox"/> Hand Rails <input type="checkbox"/> Bed Bumper / Locator Height: <input type="text" value="1350 mm"/> <input type="checkbox"/> Crash Rails <input checked="" type="checkbox"/> Chair Rail	<b>GLAZING</b> <input checked="" type="checkbox"/> Interior Glazing	<b>FLOORING TYPES</b> Material: <input type="text" value="VSF"/> Base: <input type="text" value="RB"/>	<b>ROOM ACCESSORIES</b> <input checked="" type="checkbox"/> Coat Hooks <input type="checkbox"/> Ceiling Lift <input checked="" type="checkbox"/> Magnetic Whiteboard <input type="checkbox"/> Mirror <input type="checkbox"/> Infant Change Table <input type="checkbox"/> Privacy Curtain
--	---	--	---	--

- LEGEND:**
- WALL AND CEILING LEGEND:**
- AC Architectural Ceiling
  - ACT Acoustic Ceiling Tile
  - ACT-C Cleanroom
  - ARGB Abuse-Resistant Gypsum Board
  - GB Gypsum Board
  - IRGB Impact-Resistant Gypsum Board
  - KLCT Kitchen Lay-in Ceiling Tile
  - MMRGB Moisture and Mould-Resistant Gypsum Board
  - SACT Security Acoustic Ceiling Tile
- WALL FINISHES LEGEND:**
- EWC Epoxy Wall Coating
  - HPC High Performance Coating
  - PT Paint
- CEILING FINISHES LEGEND:**
- ECC Epoxy Ceiling Coating
  - HPC High Performance Coating
  - PF Prefinished
  - PT Paint
- WALL PROTECTION LEGEND:**
- ESRP Extruded Semi-Rigid PVCu Panel
  - FRL Fibre Reinforced Laminate
  - FRP Fibreglass Reinforced Plastic
  - PVV Protective Vinyl Wallcovering
  - RHIS Rigid High Impact Sheet
  - WSSP Wetwall Solid Surface Panel
  - WVV Wetroom Vinyl Wallcovering
- FLOOR FINISHES LEGEND:**
- CFS Concrete Floor Sealer
  - EFC Epoxy Floor Coating
  - PFC Polyurethane Floor Coating
  - RAF Rubber Athletic Flooring
  - RSF Rubber Sheet Flooring
  - SCF Seamless Cushioned Flooring
  - SDRF Static-Dissipative Rubber Sheet Flooring
  - SDVF Static-Dissipative Vinyl Sheet Flooring
  - VSF Vinyl Sheet Flooring
  - WSVF Wetroom Safety Vinyl Sheet Flooring
- FLOOR BASE LEGEND:**
- FCB Flash Cove Base
  - RB Rubber Base
  - SCF Seamless Cushioned Flooring

**DOORS**

Types:

Type	Qty	Size (mm)	Material	Finish	Side Lt.	Blinds	Protect.	Privacy Film	Function	Card Reader	Mag Lock	Auto Opener	Hold Open	Hinges	Accessory 1	Accessory 2	Accessory 3	Closer
B	1	915 x 2135	Solid Core	FRL	<input type="checkbox"/>	<input type="checkbox"/>	2 High	<input checked="" type="checkbox"/>	Storeroom	<input checked="" type="checkbox"/>	<input type="checkbox"/>	<input type="checkbox"/>	<input type="checkbox"/>	Butt Hinge				Surface

Door Remarks:  Security Grille  Anti-barricade strategy

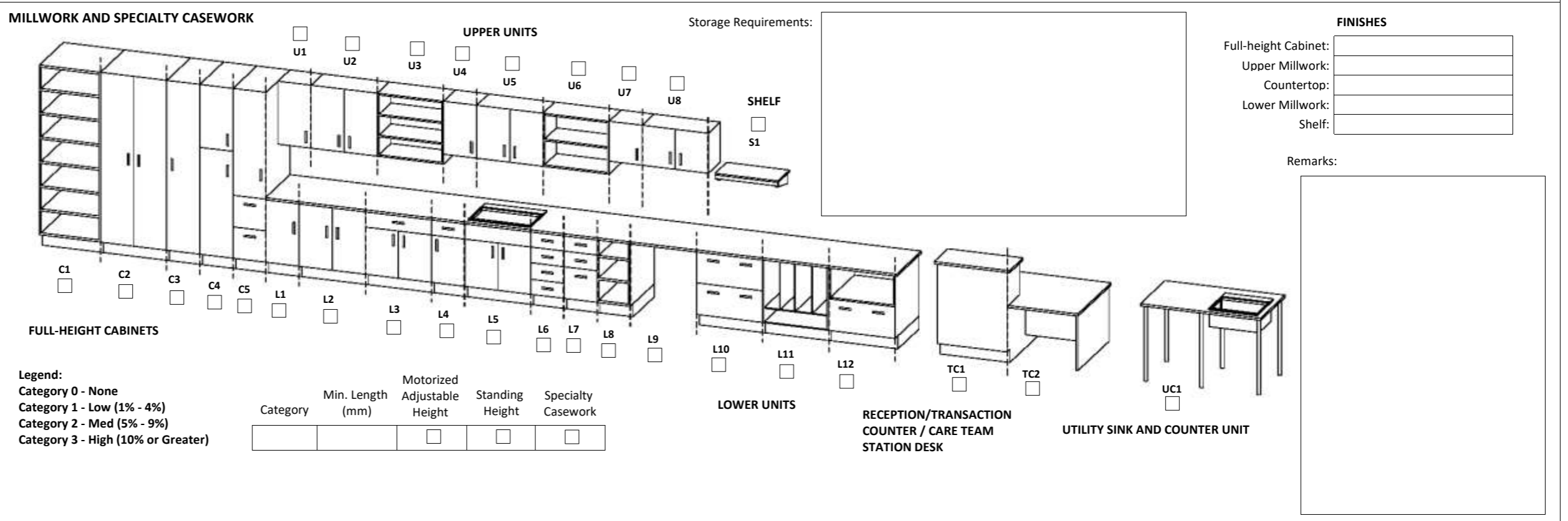

## MECHANICAL REQUIREMENTS

<b>PLUMBING</b> (Quantity) Hand Hygiene Sink: <input type="text"/> Lavatory: <input type="text"/> Kitchen Sink: <input type="text"/> Seamless Kitchen Sink: <input type="text"/> Utility / Process Sink: <input type="text"/> Scrub Sink: <input type="text"/> Floor Sink: <input type="text"/> Plumbing Remarks: <input type="text"/>	Other Fixtures: <input type="checkbox"/> Shower <input type="checkbox"/> Eyewash Station <input type="checkbox"/> Tub <input type="checkbox"/> Eyewash/Shower Station <input type="checkbox"/> Ice Maker <input type="checkbox"/> Emergency Shower <input type="checkbox"/> Water Closet <input type="checkbox"/> Flush Rim Sink <input type="checkbox"/> Instantaneous Hot Water <input type="checkbox"/> Floor Drain <input type="checkbox"/> <input type="checkbox"/> Water Bottle Refill Station Other: <input type="text"/>	<b>MED / NON-MED GASES</b> (Quantity) Oxygen: <input type="text"/> Medical Air: <input type="text"/> Medical Vacuum: <input type="text"/> Nitrous Oxide: <input type="text"/> CO2: <input type="text"/> AGSS: <input type="text"/> Nitrogen: <input type="text"/> Laboratory Air: <input type="text"/> Laboratory Vacuum: <input type="text"/> Utility Compressed Air: <input type="text"/> Gas Remarks: <input type="text"/>
---	---	---



# Appendix 1B Minimum Room Requirements

Room Name:

Program Number(s):

1. K3.11	7.	13.	19.	25.	31.	37.	43.
2. K4.11	8.	14.	20.	26.	32.	38.	44.
3.	9.	15.	21.	27.	33.	39.	45.
4.	10.	16.	22.	28.	34.	40.	46.
5.	11.	17.	23.	29.	35.	41.	47.
6.	12.	18.	24.	30.	36.	42.	48.

## ARCHITECTURAL REQUIREMENTS

<b>WALL AND CEILING</b> Wall Material: <input type="text" value="ARGB 1.2m AFF, GB above"/> Finish: <input type="text" value="PT"/> Ceiling Material: <input type="text" value="ACT"/> Finish: <input type="text" value="PF"/>		<b>WALL PROTECTION</b> Type: <input type="text" value="RHIS"/> <input checked="" type="checkbox"/> Corner Guards <input type="checkbox"/> Hand Rails <input type="checkbox"/> Bed Bumper / Locator Height: <input type="text" value="1350 mm"/> <input type="checkbox"/> Crash Rails <input checked="" type="checkbox"/> Chair Rail		<b>GLAZING</b> <input checked="" type="checkbox"/> Interior Glazing		<b>FLOORING TYPES</b> Material: <input type="text" value="VSF"/> Base: <input type="text" value="RB"/>		<b>ROOM ACCESSORIES</b> <input checked="" type="checkbox"/> Coat Hooks <input type="checkbox"/> Ceiling Lift <input checked="" type="checkbox"/> Magnetic Whiteboard <input type="checkbox"/> Mirror <input type="checkbox"/> Infant Change Table <input type="checkbox"/> Privacy Curtain	
--	--	---	--	--	--	---	--	--	--

- LEGEND:**
- WALL AND CEILING LEGEND:**
- AC Architectural Ceiling
  - ACT Acoustic Ceiling Tile
  - ACT-C Cleanroom
  - ARGB Abuse-Resistant Gypsum Board
  - GB Gypsum Board
  - IRGB Impact-Resistant Gypsum Board
  - KLCT Kitchen Lay-in Ceiling Tile
  - MMRGB Moisture and Mould-Resistant Gypsum Board
  - SACT Security Acoustic Ceiling Tile
- WALL FINISHES LEGEND:**
- EWC Epoxy Wall Coating
  - HPC High Performance Coating
  - PT Paint
- CEILING FINISHES LEGEND:**
- ECC Epoxy Ceiling Coating
  - HPC High Performance Coating
  - PF Prefinished
  - PT Paint
- WALL PROTECTION LEGEND:**
- ESRP Extruded Semi-Rigid PVCu Panel
  - FRL Fibre Reinforced Laminate
  - FRP Fibreglass Reinforced Plastic
  - PVV Protective Vinyl Wallcovering
  - RHIS Rigid High Impact Sheet
  - WSSP Wetwall Solid Surface Panel
  - WVV Wetroom Vinyl Wallcovering
- FLOOR FINISHES LEGEND:**
- CFS Concrete Floor Sealer
  - EFC Epoxy Floor Coating
  - PFC Polyurethane Floor Coating
  - RAF Rubber Athletic Flooring
  - RSF Rubber Sheet Flooring
  - SCF Seamless Cushioned Flooring
  - SDRF Static-Dissipative Rubber Sheet Flooring
  - SDVF Static-Dissipative Vinyl Sheet Flooring
  - VSF Vinyl Sheet Flooring
  - WSVF Wetroom Safety Vinyl Sheet Flooring
- FLOOR BASE LEGEND:**
- FCB Flash Cove Base
  - RB Rubber Base
  - SCF Seamless Cushioned Flooring

**DOORS**

Types:

Type	Qty	Size (mm)	Material	Finish	Side Lt.	Blinds	Protect.	Film	Function	Card Reader	Mag Lock	Auto Opener	Hold Open	Hinges	Accessory 1	Accessory 2	Accessory 3	Closer
B	1	915 x 2135	Solid Core	FRL	<input type="checkbox"/>	<input type="checkbox"/>	2 High	<input type="checkbox"/>	Storeroom	<input checked="" type="checkbox"/>	<input type="checkbox"/>	<input type="checkbox"/>	<input type="checkbox"/>	Butt Hinge				Surface

Door Remarks:  Security Grille  Anti-barricade strategy

Room K4.11 to have two Type B doors installed.



## MECHANICAL REQUIREMENTS

<b>PLUMBING</b> (Quantity) Hand Hygiene Sink: <input type="text"/> Lavatory: <input type="text"/> Kitchen Sink: <input type="text"/> Seamless Kitchen Sink: <input type="text"/> Utility / Process Sink: <input type="text"/> Scrub Sink: <input type="text"/> Floor Sink: <input type="text"/>							Other Fixtures: <input type="checkbox"/> Shower <input type="checkbox"/> Eyewash Station <input type="checkbox"/> Tub <input type="checkbox"/> Eyewash/Shower Station <input type="checkbox"/> Ice Maker <input type="checkbox"/> Emergency Shower <input type="checkbox"/> Water Closet <input type="checkbox"/> Flush Rim Sink <input type="checkbox"/> Instantaneous Hot Water <input type="checkbox"/> Floor Drain <input type="checkbox"/> Water Bottle Refill Station Other: <input type="text"/>				<b>MED / NON-MED GASES</b> (Quantity) Oxygen: <input type="text"/> Medical Air: <input type="text"/> Medical Vacuum: <input type="text"/> Nitrous Oxide: <input type="text"/> CO2: <input type="text"/> AGSS: <input type="text"/> Nitrogen: <input type="text"/> Laboratory Air: <input type="text"/> Laboratory Vacuum: <input type="text"/> Utility Compressed Air: <input type="text"/>				
Plumbing Remarks: <input type="text"/>							Gas Remarks: <input type="text"/>								

**Appendix 1B Minimum Room Requirements**

Room Name:

Program Number(s):

1. D2.09	7.	13.	19.	25.	31.	37.	43.
2.	8.	14.	20.	26.	32.	38.	44.
3.	9.	15.	21.	27.	33.	39.	45.
4.	10.	16.	22.	28.	34.	40.	46.
5.	11.	17.	23.	29.	35.	41.	47.
6.	12.	18.	24.	30.	36.	42.	48.

**ARCHITECTURAL REQUIREMENTS**

<b>WALL AND CEILING</b> Wall Material: <input type="text" value="ARGB 1.2m AFF, GB above"/> Finish: <input type="text" value="PT"/> Ceiling Material: <input type="text" value="ACT"/> Finish: <input type="text" value="PF"/>	<b>WALL PROTECTION</b> Type: <input type="text" value="FRP"/> <input checked="" type="checkbox"/> Corner Guards <input type="checkbox"/> Hand Rails <input type="checkbox"/> Bed Bumper / Locator Height: <input type="text" value="2185 mm"/> <input type="checkbox"/> Crash Rails <input checked="" type="checkbox"/> Chair Rail	<b>GLAZING</b> <input type="checkbox"/> Interior Glazing	<b>FLOORING TYPES</b> Material: <input type="text" value="VSF"/> Base: <input type="text" value="RB"/>	<b>ROOM ACCESSORIES</b> <input checked="" type="checkbox"/> Coat Hooks <input type="checkbox"/> Ceiling Lift <input checked="" type="checkbox"/> Magnetic Whiteboard <input type="checkbox"/> Mirror <input type="checkbox"/> Infant Change Table <input type="checkbox"/> Privacy Curtain
--	--	---	---	--

- LEGEND:**
- WALL AND CEILING LEGEND:**
- AC Architectural Ceiling
  - ACT Acoustic Ceiling Tile
  - ACT-C Cleanroom
  - ARGB Abuse-Resistant Gypsum Board
  - GB Gypsum Board
  - IRGB Impact-Resistant Gypsum Board
  - KLCT Kitchen Lay-in Ceiling Tile
  - MMRGB Moisture and Mould-Resistant Gypsum Board
  - SACT Security Acoustic Ceiling Tile
- WALL FINISHES LEGEND:**
- EWC Epoxy Wall Coating
  - HPC High Performance Coating
  - PT Paint
- CEILING FINISHES LEGEND:**
- ECC Epoxy Ceiling Coating
  - HPC High Performance Coating
  - PF Prefinished
  - PT Paint
- WALL PROTECTION LEGEND:**
- ESRP Extruded Semi-Rigid PVCu Panel
  - FRL Fibre Reinforced Laminate
  - FRP Fibreglass Reinforced Plastic
  - PVV Protective Vinyl Wallcovering
  - RHIS Rigid High Impact Sheet
  - WSSP Wetwall Solid Surface Panel
  - WVV Wetroom Vinyl Wallcovering
- FLOOR FINISHES LEGEND:**
- CFS Concrete Floor Sealer
  - EFC Epoxy Floor Coating
  - PFC Polyurethane Floor Coating
  - RAF Rubber Athletic Flooring
  - RSF Rubber Sheet Flooring
  - SCF Seamless Cushioned Flooring
  - SDRF Static-Dissipative Rubber Sheet Flooring
  - SDVF Static-Dissipative Vinyl Sheet Flooring
  - VSF Vinyl Sheet Flooring
  - WSVF Wetroom Safety Vinyl Sheet Flooring
- FLOOR BASE LEGEND:**
- FCB Flash Cove Base
  - RB Rubber Base
  - SCF Seamless Cushioned Flooring

**DOORS**

Types:

Type	Qty	Size (mm)	Material	Finish	Side Lt.	Blinds	Protect.	Privacy Film	Function	Card Reader	Mag Lock	Auto Opener	Hold Open	Hinges	Accessory 1	Accessory 2	Accessory 3	Closer
B	1	915 x 2135	Solid Core	FRL	<input type="checkbox"/>	<input type="checkbox"/>	2 High	<input type="checkbox"/>	Storeroom	<input checked="" type="checkbox"/>	<input type="checkbox"/>	<input type="checkbox"/>	<input type="checkbox"/>	Butt Hinge				Surface

Door Remarks:  Security Grille  Anti-barricade strategy



**MECHANICAL REQUIREMENTS**

<b>PLUMBING</b> (Quantity) Hand Hygiene Sink: <input type="text"/> Lavatory: <input type="text"/> Kitchen Sink: <input type="text"/> Seamless Kitchen Sink: <input type="text"/> Utility / Process Sink: <input type="text"/> Scrub Sink: <input type="text"/> Floor Sink: <input type="text"/> Plumbing Remarks: <input type="text"/>	Other Fixtures: <input type="checkbox"/> Shower <input type="checkbox"/> Eyewash Station <input type="checkbox"/> Tub <input type="checkbox"/> Eyewash/Shower Station <input type="checkbox"/> Ice Maker <input type="checkbox"/> Emergency Shower <input type="checkbox"/> Water Closet <input type="checkbox"/> Flush Rim Sink <input type="checkbox"/> Instantaneous Hot Water <input type="checkbox"/> Floor Drain <input type="checkbox"/> <input type="checkbox"/> Water Bottle Refill Station Other <input type="text"/>	<b>MED / NON-MED GASES</b> (Quantity) Oxygen: <input type="text"/> Medical Air: <input type="text"/> Medical Vacuum: <input type="text"/> Nitrous Oxide: <input type="text"/> CO2: <input type="text"/> AGSS: <input type="text"/> Nitrogen: <input type="text"/> Laboratory Air: <input type="text"/> Laboratory Vacuum: <input type="text"/> Utility Compressed Air: <input type="text"/> Gas Remarks: <input type="text"/>
---	--	---

# Appendix 1B Minimum Room Requirements

Room Name:

Program Number(s):	1. N2.04	7.	13.	19.	25.	31.	37.	43.
	2.	8.	14.	20.	26.	32.	38.	44.
	3.	9.	15.	21.	27.	33.	39.	45.
	4.	10.	16.	22.	28.	34.	40.	46.
	5.	11.	17.	23.	29.	35.	41.	47.
	6.	12.	18.	24.	30.	36.	42.	48.

## ARCHITECTURAL REQUIREMENTS

<b>WALL AND CEILING</b> Wall Material: <input type="text" value="ARGB 1.2m AFF, GB above"/> Finish: <input type="text" value="PT"/> Ceiling Material: <input type="text" value="ACT"/> Finish: <input type="text" value="PF"/>	<b>WALL PROTECTION</b> Type: <input type="text" value="PVW"/> <input checked="" type="checkbox"/> Corner Guards <input type="checkbox"/> Hand Rails <input type="checkbox"/> Bed Bumper / Locator Height: <input type="text" value="1350 mm"/> <input type="checkbox"/> Crash Rails <input checked="" type="checkbox"/> Chair Rail	<b>GLAZING</b> <input checked="" type="checkbox"/> Interior Glazing	<b>FLOORING TYPES</b> Material: <input type="text" value="VSF"/> Base: <input type="text" value="RB"/>	<b>ROOM ACCESSORIES</b> <input checked="" type="checkbox"/> Coat Hooks <input type="checkbox"/> Ceiling Lift <input checked="" type="checkbox"/> Magnetic Whiteboard <input type="checkbox"/> Mirror <input type="checkbox"/> Infant Change Table <input type="checkbox"/> Privacy Curtain
--	--	--	---	--

- LEGEND:**
- WALL AND CEILING LEGEND:**
- AC Architectural Ceiling
  - ACT Acoustic Ceiling Tile
  - ACT-C Cleanroom
  - ARGB Abuse-Resistant Gypsum Board
  - GB Gypsum Board
  - IRGB Impact-Resistant Gypsum Board
  - KLCT Kitchen Lay-in Ceiling Tile
  - MMRGB Moisture and Mould-Resistant Gypsum Board
  - SACT Security Acoustic Ceiling Tile
- WALL FINISHES LEGEND:**
- EWC Epoxy Wall Coating
  - HPC High Performance Coating
  - PT Paint
- CEILING FINISHES LEGEND:**
- ECC Epoxy Ceiling Coating
  - HPC High Performance Coating
  - PF Prefinished
  - PT Paint
- WALL PROTECTION LEGEND:**
- ESRP Extruded Semi-Rigid PVCu Panel
  - FRL Fibre Reinforced Laminate
  - FRP Fibreglass Reinforced Plastic
  - PVW Protective Vinyl Wallcovering
  - RHIS Rigid High Impact Sheet
  - WSSP Wetwall Solid Surface Panel
  - WVV Wetroom Vinyl Wallcovering
- FLOOR FINISHES LEGEND:**
- CFS Concrete Floor Sealer
  - EFC Epoxy Floor Coating
  - PFC Polyurethane Floor Coating
  - RAF Rubber Athletic Flooring
  - RSF Rubber Sheet Flooring
  - SCF Seamless Cushioned Flooring
  - SDRF Static-Dissipative Rubber Sheet Flooring
  - SDVF Static-Dissipative Vinyl Sheet Flooring
  - VSF Vinyl Sheet Flooring
  - WSVF Wetroom Safety Vinyl Sheet Flooring
- FLOOR BASE LEGEND:**
- FCB Flash Cove Base
  - RB Rubber Base
  - SCF Seamless Cushioned Flooring

**DOORS**

Types:

Type	Qty	Size (mm)	Material	Finish	Side Lt.	Blinds	Protect.	Privacy Film	Function	Card Reader	Mag Lock	Auto Opener	Hold Open	Hinges	Accessory 1	Accessory 2	Accessory 3	Closer
C	1	915 x 2135	Solid Core	FRL	<input type="checkbox"/>	<input type="checkbox"/>	2 High	<input type="checkbox"/>	Storeroom	<input checked="" type="checkbox"/>	<input type="checkbox"/>	<input type="checkbox"/>	<input type="checkbox"/>	Butt Hinge				Surface

Door Remarks:

Security Grille  
 Anti-barricade strategy

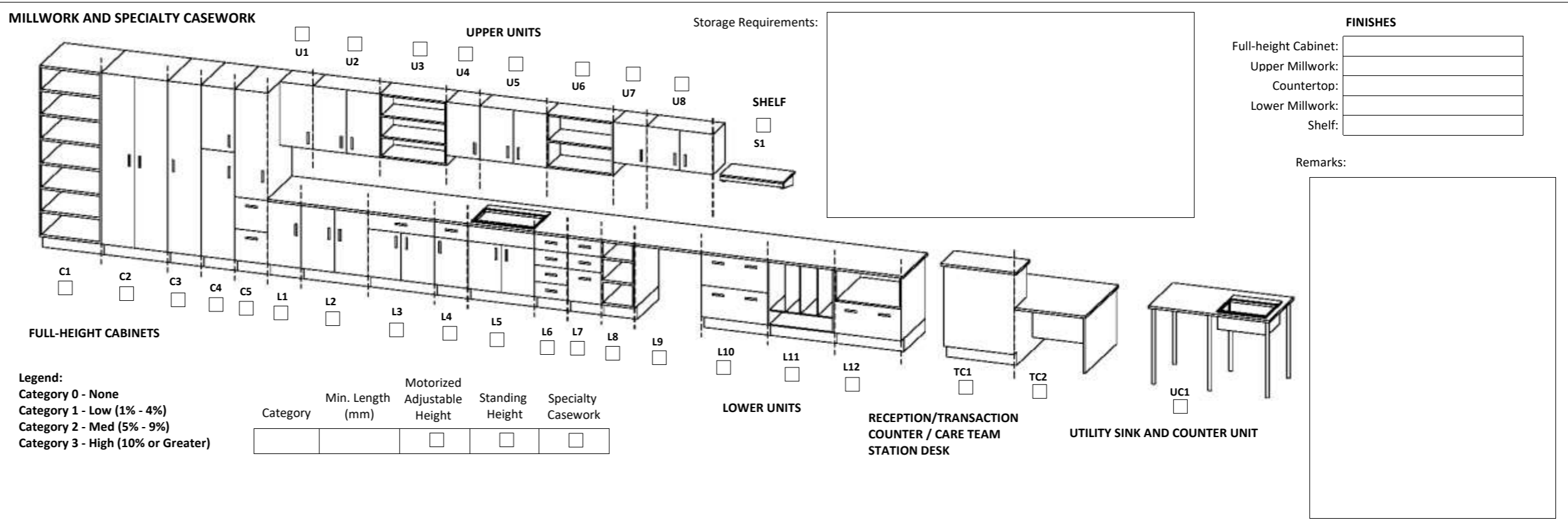

## MECHANICAL REQUIREMENTS

<b>PLUMBING</b> (Quantity) Hand Hygiene Sink: <input type="text"/> Lavatory: <input type="text"/> Kitchen Sink: <input type="text"/> Seamless Kitchen Sink: <input type="text"/> Utility / Process Sink: <input type="text"/> Scrub Sink: <input type="text"/> Floor Sink: <input type="text"/> Plumbing Remarks: <input type="text"/>	Other Fixtures: <input type="checkbox"/> Shower <input type="checkbox"/> Tub <input type="checkbox"/> Ice Maker <input type="checkbox"/> Water Closet <input type="checkbox"/> Instantaneous Hot Water <input type="checkbox"/> Eyewash Station <input type="checkbox"/> Eyewash/Shower Station <input type="checkbox"/> Emergency Shower <input type="checkbox"/> Flush Rim Sink <input type="checkbox"/> Floor Drain <input type="checkbox"/> Water Bottle Refill Station Other: <input type="text"/>	<b>MED / NON-MED GASES</b> (Quantity) Oxygen: <input type="text"/> Medical Air: <input type="text"/> Medical Vacuum: <input type="text"/> Nitrous Oxide: <input type="text"/> CO2: <input type="text"/> AGSS: <input type="text"/> Nitrogen: <input type="text"/> Laboratory Air: <input type="text"/> Laboratory Vacuum: <input type="text"/> Utility Compressed Air: <input type="text"/> Gas Remarks: <input type="text"/>
---	---	---



**Appendix 1B Minimum Room Requirements**

Room Name:

Program Number(s):

1. M1.04	7.	13.	19.	25.	31.	37.	43.
2.	8.	14.	20.	26.	32.	38.	44.
3.	9.	15.	21.	27.	33.	39.	45.
4.	10.	16.	22.	28.	34.	40.	46.
5.	11.	17.	23.	29.	35.	41.	47.
6.	12.	18.	24.	30.	36.	42.	48.

**ARCHITECTURAL REQUIREMENTS**

<b>WALL AND CEILING</b> Wall Material: <input type="text" value="ARGB 1.2m AFF, GB above"/> Finish: <input type="text" value="PT"/> Ceiling Material: <input type="text" value="ACT"/> Finish: <input type="text" value="PF"/>	<b>WALL PROTECTION</b> Type: <input type="text" value="PVW"/> <input checked="" type="checkbox"/> Corner Guards <input type="checkbox"/> Hand Rails <input type="checkbox"/> Bed Bumper / Locator Height: <input type="text" value="1350 mm"/> <input type="checkbox"/> Crash Rails <input checked="" type="checkbox"/> Chair Rail	<b>GLAZING</b> <input type="checkbox"/> Interior Glazing	<b>FLOORING TYPES</b> Material: <input type="text" value="VSF"/> Base: <input type="text" value="RB"/>	<b>ROOM ACCESSORIES</b> <input checked="" type="checkbox"/> Coat Hooks <input type="checkbox"/> Ceiling Lift <input checked="" type="checkbox"/> Magnetic Whiteboard <input type="checkbox"/> Mirror <input type="checkbox"/> Infant Change Table <input type="checkbox"/> Privacy Curtain
--	--	---	---	--

- LEGEND:**
- WALL AND CEILING LEGEND:**
- AC Architectural Ceiling
  - ACT Acoustic Ceiling Tile
  - ACT-C Cleanroom
  - ARGB Abuse-Resistant Gypsum Board
  - GB Gypsum Board
  - IRGB Impact-Resistant Gypsum Board
  - KLCT Kitchen Lay-in Ceiling Tile
  - MMRGB Moisture and Mould-Resistant Gypsum Board
  - SACT Security Acoustic Ceiling Tile
- WALL FINISHES LEGEND:**
- EWC Epoxy Wall Coating
  - HPC High Performance Coating
  - PT Paint
- CEILING FINISHES LEGEND:**
- ECC Epoxy Ceiling Coating
  - HPC High Performance Coating
  - PF Prefinished
  - PT Paint
- WALL PROTECTION LEGEND:**
- ESRP Extruded Semi-Rigid PVCu Panel
  - FRL Fibre Reinforced Laminate
  - FRP Fibreglass Reinforced Plastic
  - PVW Protective Vinyl Wallcovering
  - RHIS Rigid High Impact Sheet
  - WSSP Wetwall Solid Surface Panel
  - WVV Wetroom Vinyl Wallcovering
- FLOOR FINISHES LEGEND:**
- CFS Concrete Floor Sealer
  - EFC Epoxy Floor Coating
  - PFC Polyurethane Floor Coating
  - RAF Rubber Athletic Flooring
  - RSF Rubber Sheet Flooring
  - SCF Seamless Cushioned Flooring
  - SDRF Static-Dissipative Rubber Sheet Flooring
  - SDVF Static-Dissipative Vinyl Sheet Flooring
  - VSF Vinyl Sheet Flooring
  - WSVF Wetroom Safety Vinyl Sheet Flooring
- FLOOR BASE LEGEND:**
- FCB Flash Cove Base
  - RB Rubber Base
  - SCF Seamless Cushioned Flooring

**DOORS**

Types:

Type	Qty	Size (mm)	Material	Finish	Side Lt.	Blinds	Protect.	Privacy Film	Function	Card Reader	Mag Lock	Auto Opener	Hold Open	Hinges	Accessory 1	Accessory 2	Accessory 3	Closer
B	1	915 x 2135	Solid Core	FRL	<input type="checkbox"/>	<input type="checkbox"/>	1 Low	<input checked="" type="checkbox"/>	Passage	<input type="checkbox"/>	<input type="checkbox"/>	<input type="checkbox"/>	<input type="checkbox"/>	Butt Hinge				Surface

Door Remarks:  Security Grille  Anti-barricade strategy

**MILLWORK AND SPECIALTY CASEWORK**

Storage Requirements:

**FINISHES**

Full-height Cabinet:

Upper Millwork:

Countertop:

Lower Millwork:

Shelf:

Remarks:

**Legend:**

Category	Min. Length (mm)	Motorized Adjustable Height	Standing Height	Specialty Casework
Category 0 - None		<input type="checkbox"/>	<input type="checkbox"/>	<input type="checkbox"/>
Category 1 - Low (1% - 4%)		<input type="checkbox"/>	<input type="checkbox"/>	<input type="checkbox"/>
Category 2 - Med (5% - 9%)		<input type="checkbox"/>	<input type="checkbox"/>	<input type="checkbox"/>
Category 3 - High (10% or Greater)		<input type="checkbox"/>	<input type="checkbox"/>	<input type="checkbox"/>

**MECHANICAL REQUIREMENTS**

<b>PLUMBING</b> (Quantity) Hand Hygiene Sink: <input type="text"/> Lavatory: <input type="text"/> Kitchen Sink: <input type="text"/> Seamless Kitchen Sink: <input type="text"/> Utility / Process Sink: <input type="text"/> Scrub Sink: <input type="text"/> Floor Sink: <input type="text"/> Plumbing Remarks: <input type="text"/>	Other Fixtures: <input type="checkbox"/> Shower <input type="checkbox"/> Eyewash Station <input type="checkbox"/> Tub <input type="checkbox"/> Eyewash/Shower Station <input type="checkbox"/> Ice Maker <input type="checkbox"/> Emergency Shower <input type="checkbox"/> Water Closet <input type="checkbox"/> Flush Rim Sink <input type="checkbox"/> Instantaneous Hot Water <input type="checkbox"/> Floor Drain <input type="checkbox"/> <input type="checkbox"/> Water Bottle Refill Station Other <input type="text"/>	<b>MED / NON-MED GASES</b> (Quantity) Oxygen: <input type="text"/> Medical Air: <input type="text"/> Medical Vacuum: <input type="text"/> Nitrous Oxide: <input type="text"/> CO2: <input type="text"/> AGSS: <input type="text"/> Nitrogen: <input type="text"/> Laboratory Air: <input type="text"/> Laboratory Vacuum: <input type="text"/> Utility Compressed Air: <input type="text"/> Gas Remarks: <input type="text"/>
---	--	---

**Appendix 1B Minimum Room Requirements**

Room Name:

Program Number(s):

1. G3.01	7.	13.	19.	25.	31.	37.	43.
2.	8.	14.	20.	26.	32.	38.	44.
3.	9.	15.	21.	27.	33.	39.	45.
4.	10.	16.	22.	28.	34.	40.	46.
5.	11.	17.	23.	29.	35.	41.	47.
6.	12.	18.	24.	30.	36.	42.	48.

**ARCHITECTURAL REQUIREMENTS**

<b>WALL AND CEILING</b> Wall Material: <input type="text" value="ARGB 1.2m AFF, GB above"/> Finish: <input type="text" value="PT"/> Ceiling Material: <input type="text" value="ACT"/> Finish: <input type="text" value="PF"/>	<b>WALL PROTECTION</b> Type: <input type="text" value="RHIS"/> <input checked="" type="checkbox"/> Corner Guards <input type="checkbox"/> Hand Rails <input type="checkbox"/> Bed Bumper / Locator Height: <input type="text" value="1350 mm"/> <input type="checkbox"/> Crash Rails <input checked="" type="checkbox"/> Chair Rail	<b>GLAZING</b> <input checked="" type="checkbox"/> Interior Glazing	<b>FLOORING TYPES</b> Material: <input type="text" value="RSF"/> Base: <input type="text" value="RB"/>	<b>ROOM ACCESSORIES</b> <input checked="" type="checkbox"/> Coat Hooks <input type="checkbox"/> Ceiling Lift <input checked="" type="checkbox"/> Magnetic Whiteboard <input type="checkbox"/> Mirror <input type="checkbox"/> Infant Change Table <input type="checkbox"/> Privacy Curtain
--	---	--	---	--

- LEGEND:**
- WALL AND CEILING LEGEND:**
- AC Architectural Ceiling
  - ACT Acoustic Ceiling Tile
  - ACT-C Cleanroom
  - ARGB Abuse-Resistant Gypsum Board
  - GB Gypsum Board
  - IRGB Impact-Resistant Gypsum Board
  - KLCT Kitchen Lay-in Ceiling Tile
  - MMRGB Moisture and Mould-Resistant Gypsum Board
  - SACT Security Acoustic Ceiling Tile
- WALL FINISHES LEGEND:**
- EWC Epoxy Wall Coating
  - HPC High Performance Coating
  - PT Paint
- CEILING FINISHES LEGEND:**
- ECC Epoxy Ceiling Coating
  - HPC High Performance Coating
  - PF Prefinished
  - PT Paint
- WALL PROTECTION LEGEND:**
- ESRP Extruded Semi-Rigid PVCu Panel
  - FRL Fibre Reinforced Laminate
  - FRP Fibreglass Reinforced Plastic
  - PVV Protective Vinyl Wallcovering
  - RHIS Rigid High Impact Sheet
  - WSSP Wetwall Solid Surface Panel
  - WVV Wetroom Vinyl Wallcovering
- FLOOR FINISHES LEGEND:**
- CFS Concrete Floor Sealer
  - EFC Epoxy Floor Coating
  - PFC Polyurethane Floor Coating
  - RAF Rubber Athletic Flooring
  - RSF Rubber Sheet Flooring
  - SCF Seamless Cushioned Flooring
  - SDRF Static-Dissipative Rubber Sheet Flooring
  - SDVF Static-Dissipative Vinyl Sheet Flooring
  - VSF Vinyl Sheet Flooring
  - WSVF Wetroom Safety Vinyl Sheet Flooring
- FLOOR BASE LEGEND:**
- FCB Flash Cove Base
  - RB Rubber Base
  - SCF Seamless Cushioned Flooring

**DOORS**

Types:

Type	Qty	Size (mm)	Material	Finish	Side Lt	Blinds	Protect	Privacy Film	Function	Card Reader	Mag Lock	Auto Opener	Hold Open	Hinges	Accessory 1	Accessory 2	Accessory 3	Closer
B	1	915 x 2135	Solid Core	FRL	<input type="checkbox"/>	<input type="checkbox"/>	1 Low	<input checked="" type="checkbox"/>	Storeroom	<input checked="" type="checkbox"/>	<input type="checkbox"/>	<input type="checkbox"/>	<input type="checkbox"/>	Butt Hinge				Surface

Door Remarks:  Security Grille  Anti-barricade strategy



**MECHANICAL REQUIREMENTS**

<b>PLUMBING</b> (Quantity) Hand Hygiene Sink: <input type="text"/> Lavatory: <input type="text"/> Kitchen Sink: <input type="text"/> Seamless Kitchen Sink: <input type="text"/> Utility / Process Sink: <input type="text"/> Scrub Sink: <input type="text"/> Floor Sink: <input type="text"/> Plumbing Remarks: <input type="text"/>	Other Fixtures: <input type="checkbox"/> Shower <input type="checkbox"/> Eyewash Station <input type="checkbox"/> Tub <input type="checkbox"/> Eyewash/Shower Station <input type="checkbox"/> Ice Maker <input type="checkbox"/> Emergency Shower <input type="checkbox"/> Water Closet <input type="checkbox"/> Flush Rim Sink <input type="checkbox"/> Instantaneous Hot Water <input type="checkbox"/> Floor Drain <input type="checkbox"/> <input type="checkbox"/> Water Bottle Refill Station Other: <input type="text"/>	<b>MED / NON-MED GASES</b> (Quantity) Oxygen: <input type="text"/> Medical Air: <input type="text"/> Medical Vacuum: <input type="text"/> Nitrous Oxide: <input type="text"/> CO2: <input type="text"/> AGSS: <input type="text"/> Nitrogen: <input type="text"/> Laboratory Air: <input type="text"/> Laboratory Vacuum: <input type="text"/> Utility Compressed Air: <input type="text"/> Gas Remarks: <input type="text"/>
---	---	---

**Appendix 1B Minimum Room Requirements**

Room Name:

Program Number(s):

1. E2.01.09	7. J5.06	13.	19.	25.	31.	37.	43.
2. E4.01.06	8. K1.11	14.	20.	26.	32.	38.	44.
3. Not Used	9. L2.13	15.	21.	27.	33.	39.	45.
4. E7.03	10. L3.04	16.	22.	28.	34.	40.	46.
5. G3.06	11. N1.03	17.	23.	29.	35.	41.	47.
6. H1.06	12. P3.02.01	18.	24.	30.	36.	42.	48.

**ARCHITECTURAL REQUIREMENTS**

<b>WALL AND CEILING</b> Wall Material: <input type="text" value="GB"/> Finish: <input type="text" value="PT"/> Ceiling Material: <input type="text" value="ACT"/> Finish: <input type="text" value="PF"/>	<b>WALL PROTECTION</b> Type: <input type="text" value="PVW"/> Height: <input type="text" value="1600 mm"/> <input type="checkbox"/> Corner Guards <input type="checkbox"/> Hand Rails <input type="checkbox"/> Bed Bumper / Locator <input type="checkbox"/> Crash Rails <input checked="" type="checkbox"/> Chair Rail	<b>GLAZING</b> <input type="checkbox"/> Interior Glazing	<b>FLOORING TYPES</b> Material: <input type="text" value="VSF"/> Base: <input type="text" value="RB"/>	<b>ROOM ACCESSORIES</b> <input type="checkbox"/> Coat Hooks <input type="checkbox"/> Ceiling Lift <input type="checkbox"/> Magnetic Whiteboard <input type="checkbox"/> Mirror <input type="checkbox"/> Infant Change Table <input type="checkbox"/> Privacy Curtain
---	--	---	---	--

- LEGEND:**
- WALL AND CEILING LEGEND:**
- AC Architectural Ceiling
  - ACT Acoustic Ceiling Tile
  - ACT-C Cleanroom
  - ARGB Abuse-Resistant Gypsum Board
  - GB Gypsum Board
  - IRGB Impact-Resistant Gypsum Board
  - KLCT Kitchen Lay-in Ceiling Tile
  - MMRGB Moisture and Mould-Resistant Gypsum Board
  - SACT Security Acoustic Ceiling Tile
- WALL FINISHES LEGEND:**
- EWC Epoxy Wall Coating
  - HPC High Performance Coating
  - PT Paint
- CEILING FINISHES LEGEND:**
- ECC Epoxy Ceiling Coating
  - HPC High Performance Coating
  - PF Prefinished
  - PT Paint
- WALL PROTECTION LEGEND:**
- ESRP Extruded Semi-Rigid PVCu Panel
  - FRL Fibre Reinforced Laminate
  - FRP Fibreglass Reinforced Plastic
  - PVW Protective Vinyl Wallcovering
  - RHIS Rigid High Impact Sheet
  - WSSP Wetwall Solid Surface Panel
  - WWW Wetroom Vinyl Wallcovering
- FLOOR FINISHES LEGEND:**
- CFS Concrete Floor Sealer
  - EFC Epoxy Floor Coating
  - PFC Polyurethane Floor Coating
  - RAF Rubber Athletic Flooring
  - RSF Rubber Sheet Flooring
  - SCF Seamless Cushioned Flooring
  - SDRF Static-Dissipative Rubber Sheet Flooring
  - SDVF Static-Dissipative Vinyl Sheet Flooring
  - VSF Vinyl Sheet Flooring
  - WSVF Wetroom Safety Vinyl Sheet Flooring
- FLOOR BASE LEGEND:**
- FCB Flash Cove Base
  - RB Rubber Base
  - SCF Seamless Cushioned Flooring

**DOORS**

Types:

Type:Qty:	Size (mm):	Material:	Finish:	Side Lt:	Blinds:	Protect.:	Film:	Function:	Card Reader:	Mag Lock:	Auto Opener:	Hold Open:	Hinges:	Accessory 1:	Accessory 2:	Accessory 3:	Closer:

Door Remarks:  Security Grille  Anti-barricade strategy

**MILLWORK AND SPECIALTY CASEWORK**

Storage Requirements:

**UPPER UNITS** U1 U2 U3 U4 U5 U6 U7 U8

**LOWER UNITS** L1 L2 L3 L4 L5 L6 L7 L8 L9 L10 L11 L12

**FULL-HEIGHT CABINETS** C1 C2 C3 C4 C5

**SHELF** S1

**RECEPTION/TRANSACTION COUNTER / CARE TEAM STATION DESK** TC1 TC2

**UTILITY SINK AND COUNTER UNIT** UC1

**FINISHES**

Full-height Cabinet:   
 Upper Millwork:   
 Countertop:   
 Lower Millwork:   
 Shelf:

Remarks: Provide Specialty Casework for E2.01.09, E4.01.06. Refer to Schedule 1, Section 6.12 (Division 12) for Specialty Casework. Items indicated are diagrammatic, provide specialty casework appropriate for the specific and specialized functions to be performed in the space and to accommodate Equipment. Provide laboratory casework, quantity (1) per room.

Category	Min. Length (mm)	Motorized Adjustable Height	Standing Height	Specialty Casework
Category 0 - None				
Category 1 - Low (1% - 4%)				
Category 2 - Med (5% - 9%)				
Category 3 - High (10% or Greater)				

**MECHANICAL REQUIREMENTS**

<b>PLUMBING</b> (Quantity) Hand Hygiene Sink: <input type="text"/> Lavatory: <input type="text"/> Kitchen Sink: <input type="text"/> Seamless Kitchen Sink: <input type="text"/> Utility / Process Sink: <input type="text"/> Scrub Sink: <input type="text"/> Floor Sink: <input type="text"/> Plumbing Remarks: <input type="text"/>	Other Fixtures: <input type="checkbox"/> Shower <input type="checkbox"/> Eyewash Station <input type="checkbox"/> Tub <input type="checkbox"/> Eyewash/Shower Station <input type="checkbox"/> Ice Maker <input type="checkbox"/> Emergency Shower <input type="checkbox"/> Water Closet <input type="checkbox"/> Flush Rim Sink <input type="checkbox"/> Instantaneous Hot Water <input type="checkbox"/> Floor Drain <input type="checkbox"/> Water Bottle Refill Station Other: <input type="text"/>	<b>MED / NON-MED GASES</b> (Quantity) Oxygen: <input type="text"/> Medical Air: <input type="text"/> Medical Vacuum: <input type="text"/> Nitrous Oxide: <input type="text"/> CO2: <input type="text"/> AGSS: <input type="text"/> Nitrogen: <input type="text"/> Laboratory Air: <input type="text"/> Laboratory Vacuum: <input type="text"/> Utility Compressed Air: <input type="text"/> Gas Remarks: <input type="text"/>
---	--	---



# Appendix 1B Minimum Room Requirements

Room Name:

Program Number(s):

1. C2.04	7. R1.02.02	13.	19.	25.	31.	37.	43.
2. E2.01.07	8.	14.	20.	26.	32.	38.	44.
3. F8.06	9.	15.	21.	27.	33.	39.	45.
4. J4.01.03	10.	16.	22.	28.	34.	40.	46.
5. L3.03	11.	17.	23.	29.	35.	41.	47.
6. P2.03.06	12.	18.	24.	30.	36.	42.	48.

## ARCHITECTURAL REQUIREMENTS

<b>WALL AND CEILING</b> Wall Material: <input type="text" value="GB"/> Finish: <input type="text" value="PT"/> Ceiling Material: <input type="text" value="ACT"/> Finish: <input type="text" value="PF"/>		<b>WALL PROTECTION</b> Type: <input type="text" value="PVW"/> <input type="checkbox"/> Corner Guards <input type="checkbox"/> Hand Rails <input type="checkbox"/> Bed Bumper / Locator Height: <input type="text" value="1350 mm"/> <input type="checkbox"/> Crash Rails <input checked="" type="checkbox"/> Chair Rail			<b>GLAZING</b> <input type="checkbox"/> Interior Glazing		<b>FLOORING TYPES</b> Material: <input type="text" value="VSF"/> Base: <input type="text" value="RB"/>		<b>ROOM ACCESSORIES</b> <input type="checkbox"/> Coat Hooks <input type="checkbox"/> Ceiling Lift <input type="checkbox"/> Magnetic Whiteboard <input type="checkbox"/> Mirror <input type="checkbox"/> Infant Change Table <input type="checkbox"/> Privacy Curtain		
---	--	---	--	--	---	--	---	--	--	--	--

- LEGEND:**
- WALL AND CEILING LEGEND:**
- AC Architectural Ceiling
  - ACT Acoustic Ceiling Tile
  - ACT-C Cleanroom
  - ARGB Abuse-Resistant Gypsum Board
  - GB Gypsum Board
  - IRGB Impact-Resistant Gypsum Board
  - KLCT Kitchen Lay-in Ceiling Tile
  - MMRGB Moisture and Mould-Resistant Gypsum Board
  - SACT Security Acoustic Ceiling Tile
- WALL FINISHES LEGEND:**
- EWC Epoxy Wall Coating
  - HPC High Performance Coating
  - PT Paint
- CEILING FINISHES LEGEND:**
- ECC Epoxy Ceiling Coating
  - HPC High Performance Coating
  - PF Prefinished
  - PT Paint
- WALL PROTECTION LEGEND:**
- ESRP Extruded Semi-Rigid PVCu Panel
  - FRL Fibre Reinforced Laminate
  - FRP Fibreglass Reinforced Plastic
  - PVW Protective Vinyl Wallcovering
  - RHIS Rigid High Impact Sheet
  - WSSP Wetwall Solid Surface Panel
  - WWW Wetroom Vinyl Wallcovering
- FLOOR FINISHES LEGEND:**
- CFS Concrete Floor Sealer
  - EFC Epoxy Floor Coating
  - PFC Polyurethane Floor Coating
  - RAF Rubber Athletic Flooring
  - RSF Rubber Sheet Flooring
  - SCF Seamless Cushioned Flooring
  - SDRF Static-Dissipative Rubber Sheet Flooring
  - SDVF Static-Dissipative Vinyl Sheet Flooring
  - VSF Vinyl Sheet Flooring
  - WSVF Wetroom Safety Vinyl Sheet Flooring
- FLOOR BASE LEGEND:**
- FCB Flash Cove Base
  - RB Rubber Base
  - SCF Seamless Cushioned Flooring

**DOORS**

Types:

Type	Qty	Size (mm)	Material	Finish	Side Lt.	Blinds	Protect.	Privacy Film	Function	Card Reader	Mag Lock	Auto Opener	Hold Open	Hinges	Accessory 1	Accessory 2	Accessory 3	Closer

Door Remarks:  Security Grille  Anti-barricade strategy

**MILLWORK AND SPECIALTY CASEWORK**

Storage Requirements:

**UPPER UNITS** (U1-U8) **SHELF** (S1)

**FULL-HEIGHT CABINETS** (C1-C5) **LOWER UNITS** (L1-L12) **RECEPTION/TRANSACTION COUNTER / CARE TEAM STATION DESK** (TC1-TC2) **UTILITY SINK AND COUNTER UNIT** (UC1)

Category	Min. Length (mm)	Motorized Adjustable Height	Standing Height	Specialty Casework
Category 0 - None				
Category 1 - Low (1% - 4%)				
Category 2 - Med (5% - 9%)				
Category 3 - High (10% or Greater)				

**FINISHES**

Full-height Cabinet:   
 Upper Millwork:   
 Countertop:   
 Lower Millwork:   
 Shelf:

Remarks: Provide Specialty Casework for E2.01.07. Refer to Schedule 1, Section 6.12 (Division 12) for Specialty Casework. Items indicated are diagrammatic, provide specialty casework appropriate for the specific and specialized functions to be performed in the space and to accommodate Equipment. Provide laboratory casework, quantity (1) per room.

## MECHANICAL REQUIREMENTS

<b>PLUMBING</b> (Quantity) Hand Hygiene Sink: <input type="text"/> Lavatory: <input type="text"/> Kitchen Sink: <input type="text"/> Seamless Kitchen Sink: <input type="text"/> Utility / Process Sink: <input type="text"/> Scrub Sink: <input type="text"/> Floor Sink: <input type="text"/>							Other Fixtures: <input type="checkbox"/> Shower <input type="checkbox"/> Eyewash Station <input type="checkbox"/> Tub <input type="checkbox"/> Eyewash/Shower Station <input type="checkbox"/> Ice Maker <input type="checkbox"/> Emergency Shower <input type="checkbox"/> Water Closet <input type="checkbox"/> Flush Rim Sink <input type="checkbox"/> Instantaneous Hot Water <input type="checkbox"/> Floor Drain <input type="checkbox"/> Water Bottle Refill Station Other: <input type="text"/>				<b>MED / NON-MED GASES</b> (Quantity) Oxygen: <input type="text"/> Medical Air: <input type="text"/> Medical Vacuum: <input type="text"/> Nitrous Oxide: <input type="text"/> CO2: <input type="text"/> AGSS: <input type="text"/> Nitrogen: <input type="text"/> Laboratory Air: <input type="text"/> Laboratory Vacuum: <input type="text"/> Utility Compressed Air: <input type="text"/>					
Plumbing Remarks: <input type="text"/>											Gas Remarks: <input type="text"/>					

**Appendix 1B Minimum Room Requirements**

Room Name:

Program Number(s):

1. D4.01.04	7.	13.	19.	25.	31.	37.	43.
2. D4.02.03	8.	14.	20.	26.	32.	38.	44.
3.	9.	15.	21.	27.	33.	39.	45.
4.	10.	16.	22.	28.	34.	40.	46.
5.	11.	17.	23.	29.	35.	41.	47.
6.	12.	18.	24.	30.	36.	42.	48.

**ARCHITECTURAL REQUIREMENTS**

<b>WALL AND CEILING</b> Wall Material: <input type="text" value="GB"/> Finish: <input type="text" value="PT"/> Ceiling Material: <input type="text" value="ACT"/> Finish: <input type="text" value="PF"/>	<b>WALL PROTECTION</b> Type: <input type="text" value="FRP"/> <input checked="" type="checkbox"/> Corner Guards <input type="checkbox"/> Hand Rails <input type="checkbox"/> Bed Bumper / Locator Height: <input type="text" value="1350 mm"/> <input type="checkbox"/> Crash Rails <input checked="" type="checkbox"/> Chair Rail	<b>GLAZING</b> <input type="checkbox"/> Interior Glazing	<b>FLOORING TYPES</b> Material: <input type="text" value="VSF"/> Base: <input type="text" value="RB"/>	<b>ROOM ACCESSORIES</b> <input type="checkbox"/> Coat Hooks <input type="checkbox"/> Ceiling Lift <input type="checkbox"/> Magnetic Whiteboard <input type="checkbox"/> Mirror <input type="checkbox"/> Infant Change Table <input type="checkbox"/> Privacy Curtain
---	--	---	---	--

- LEGEND:**
- WALL AND CEILING LEGEND:**
- AC Architectural Ceiling
  - ACT Acoustic Ceiling Tile
  - ACT-C Cleanroom
  - ARGB Abuse-Resistant Gypsum Board
  - GB Gypsum Board
  - IRGB Impact-Resistant Gypsum Board
  - KLCT Kitchen Lay-in Ceiling Tile
  - MMRGB Moisture and Mould-Resistant Gypsum Board
  - SACT Security Acoustic Ceiling Tile
- WALL FINISHES LEGEND:**
- EWC Epoxy Wall Coating
  - HPC High Performance Coating
  - PT Paint
- CEILING FINISHES LEGEND:**
- ECC Epoxy Ceiling Coating
  - HPC High Performance Coating
  - PF Prefinished
  - PT Paint
- WALL PROTECTION LEGEND:**
- ESRP Extruded Semi-Rigid PVCu Panel
  - FRL Fibre Reinforced Laminate
  - FRP Fibreglass Reinforced Plastic
  - PVV Protective Vinyl Wallcovering
  - RHIS Rigid High Impact Sheet
  - WSSP Wetwall Solid Surface Panel
  - WVV Wetroom Vinyl Wallcovering
- FLOOR FINISHES LEGEND:**
- CFS Concrete Floor Sealer
  - EFC Epoxy Floor Coating
  - PFC Polyurethane Floor Coating
  - RAF Rubber Athletic Flooring
  - RSF Rubber Sheet Flooring
  - SCF Seamless Cushioned Flooring
  - SDRF Static-Dissipative Rubber Sheet Flooring
  - SDVF Static-Dissipative Vinyl Sheet Flooring
  - VSF Vinyl Sheet Flooring
  - WSVF Wetroom Safety Vinyl Sheet Flooring
- FLOOR BASE LEGEND:**
- FCB Flash Cove Base
  - RB Rubber Base
  - SCF Seamless Cushioned Flooring

**DOORS**

Types:

Type	Qty	Size (mm)	Material	Finish	Side Lt.	Blinds	Protect.	Privacy Film	Function	Card Reader	Mag Lock	Auto Opener	Hold Open	Hinges	Accessory 1	Accessory 2	Accessory 3	Closer

Door Remarks:  Security Grille  Anti-barricade strategy

**MILLWORK AND SPECIALTY CASEWORK**

Storage Requirements:

**UPPER UNITS** (U1-U8) **SHELF** (S1)

**LOWER UNITS** (L1-L12) **RECEPTION/TRANSACTION COUNTER / CARE TEAM STATION DESK** (TC1-TC2) **UTILITY SINK AND COUNTER UNIT** (UC1)

**FULL-HEIGHT CABINETS** (C1-C5)

**Legend:**

Category	Min. Length (mm)	Motorized Adjustable Height	Standing Height	Specialty Casework
Category 0 - None				
Category 1 - Low (1% - 4%)				
Category 2 - Med (5% - 9%)				
Category 3 - High (10% or Greater)				

**FINISHES**

Full-height Cabinet:   
 Upper Millwork:   
 Countertop:   
 Lower Millwork:   
 Shelf:

Remarks:

**MECHANICAL REQUIREMENTS**

**PLUMBING** (Quantity)

Hand Hygiene Sink:	Lavatory:	Kitchen Sink:	Seamless Kitchen Sink:	Utility / Process Sink:	Scrub Sink:	Floor Sink:
<input type="text"/>	<input type="text"/>	<input type="text"/>	<input type="text"/>	<input type="text"/>	<input type="text"/>	<input type="text"/>

Plumbing Remarks:

**Other Fixtures:**

- Shower
- Tub
- Ice Maker
- Water Closet
- Instantaneous Hot Water
- Eyewash Station
- Eyewash/Shower Station
- Emergency Shower
- Flush Rim Sink
- Floor Drain
- Water Bottle Refill Station
- Other:

**MED / NON-MED GASES** (Quantity)

Oxygen:	Medical Air:	Medical Vacuum:	Nitrous Oxide:	CO2:	AGSS:	Nitrogen:	Laboratory Air:	Laboratory Vacuum:	Utility Compressed Air:
<input type="text"/>	<input type="text"/>	<input type="text"/>	<input type="text"/>	<input type="text"/>	<input type="text"/>	<input type="text"/>	<input type="text"/>	<input type="text"/>	<input type="text"/>

Gas Remarks: